

Data sheet for three-phase Squirrel-Cage-Motors SIMOTICS

Motor type: **SD200 NEMA Premium Next Generation** FS: 449T - 4p - 300 hp -

Client order no.	Item-No.	Offer no.
Order no.	Consignment no.	Project
Remarks		

Electrical data **Class I Division 2 Gr. A, B, C or D T3 Class II**
Division 2 Gr. F or G T3C

U [V]	Δ/Y	f [Hz]	P [HP]	P [kW]	n [rpm]	I Load [Amps]					Nom. Eff Load [%]			Pwr. Factor Load [%]			Torque [lb-ft]	T _A /T _N LRT [%]	T _k /T _N BDT [%]
						4/4	3/4	1/2	0	LRC	4/4	3/4	2/4	4/4	3/4	2/4			
460	$\Delta \Delta$	60	300.00	223.80	1,785	365	273.70	216.90	144.00	2200.0	96.2	96.2	96.8	80.0	80.0	66.9	882.0	225	280
Frame Type: 449T		Type of constr.: (A) Foot Mounted Horizontal (IMB3)				Ins. Cl.: Standard Class H Insulation		Motor Prot.: A: No Winding Protection			NEMA Des.: B		S.F.: 1.15						
Mtr. WT: 2,170						Temp. Rise Cl.: B		Amb. Temp.: + 40 to °C @1000 m			kVA: G		IP 55						

Mechanical data

Sound level (SPL / SWL) at 60 Hz	83.0 dB(A) / 94.0 dB(A)		Thickener	Polyurea					
Octave Band Center Frequencies Hertz			Safe Stall Time Hot	25 s					
	250	500	1000	2000	4000	8000	Hz	Safe Stall Time Cold	30 s
SPL@3	71.0	79.0	78.0	74.0	67.0	61.0	dB(A)	Frame material	Cast iron
Moment of inertia	63.7 Lb-ft ²		Color, paint shade	RAL 7030					
Ext Load Inertia Capability:	1200.0 Lb ft ²		Coating (paint finish)	Standard Alkyed + Epoxy (C2)					
Bearings			Ventilation Type						
Bearing DE NDE	6320 Z C3 S0		6315 Z C3 S0						
Bearing_Type	Ball Bearing		Ball Bearing						
AFBMA:	100BC03JP3		75BC03JP3						
Grease			Method of cooling						
Capacity	15 oz		15 oz						
Grease Type:	Exxon Mobil EM		VFD						
			Space heaters						
			Brake:						
			without						
			-/-						

Terminal box

Lead Wire Connection	12 TERMINAL - Connection DELTA				Terminal box position	(1) LHS Mount - View From DE (F-1) - DE or Center of Motor
Voltage	L1	L1	L1	Connected together	Material of terminal box	Cast Iron
---	---	---	---	---	Cable entry	(1) 4" NPT
RUN	T12-T7-T6-T1	T10-T8-T4-T2	T11-T9-T5-T13	---		

Notes:					
I _L /I _N = locked rotor current / current nominal		3) Value is valid only for DOL operation with motor design IC411			
M _L /M _N = locked rotor torque / torque nominal		2) at rated power / at full load			
M _k /M _N = break down torque / nominal torque					

responsible dep.	technical reference	created by	approved by	<i>Technical data are subject to change! There may be discrepancies between software and hardware versions</i>	
DI MC LVM		DT Configurator			
	document type	document status		customer	
	datasheet	released			
	title	document number			
	1LE6321-4CB31-2AA1				
© Siemens AG 2022	rev.	creation date	language	Page	
	01	2022-04-09 01:01	en	1/1	

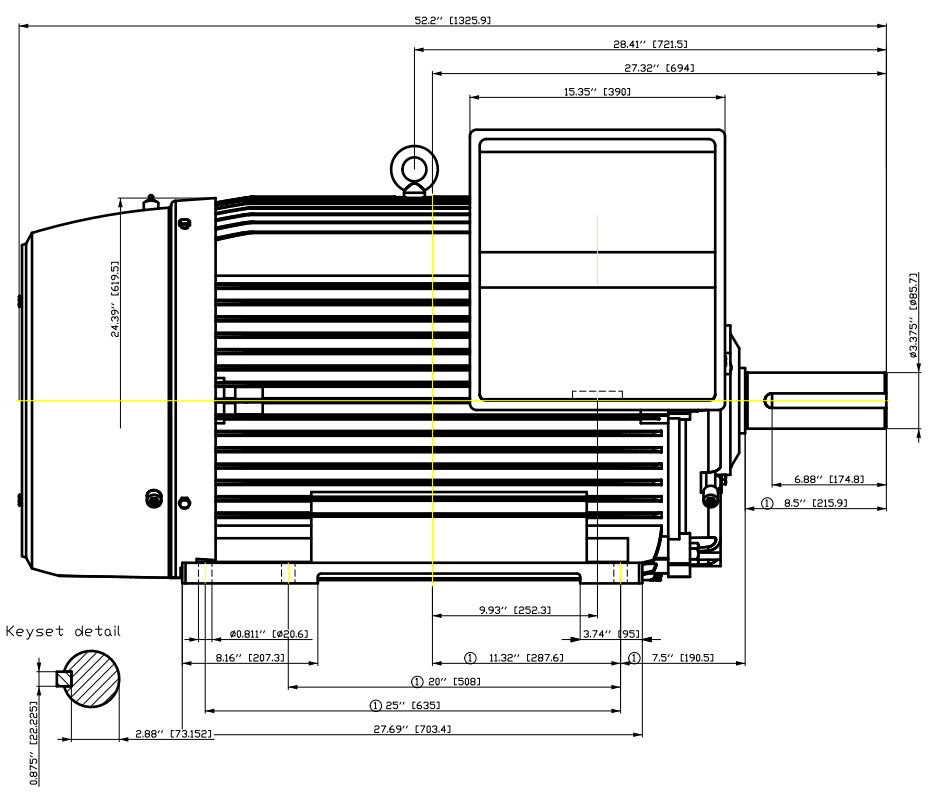
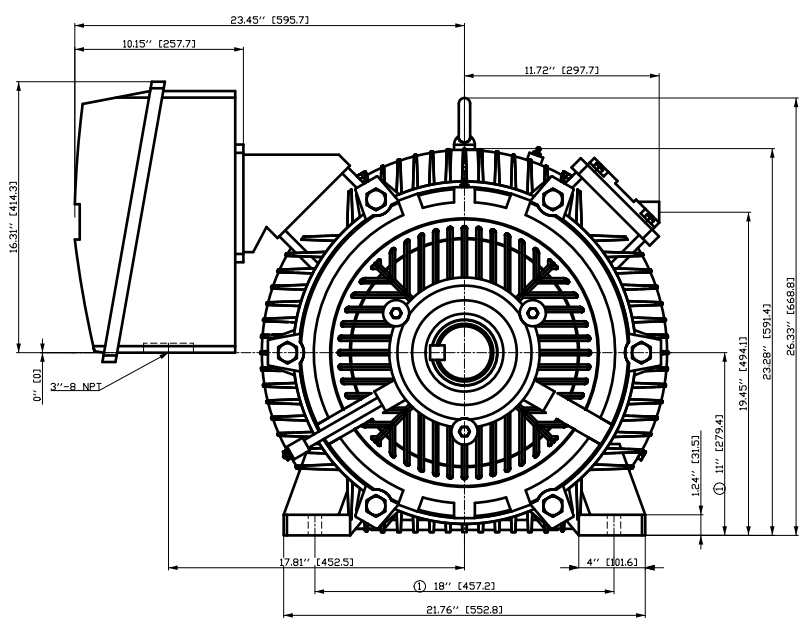

① Tolerances according to NEMA std.
 All dimensions corresponding to assemblies and castings shall have a tolerance as per ISO 8062-3 DCTG 12.

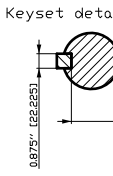

Tolerance	Surface	Material	Weight	Scale
F50 I HGF E OCH FEGODE	Author	ÖS T a : ^ @ ~ } *	E	
E	Creator			
	Approval			
	Department	MLFB	Doc Type	
	Change Order	Item No	Paper Size	CH
	Doc. State	Revision	1st Language	^
	Revision	Index	2nd Language	â
	Project No	Ref No	Sheet	F of F



© Siemens AG 2018

SIEMENS INDUSTRY, INC.

HP 300 VOLTS 460 RPM 1785 TYPE SD200
HZ 60 PHASE 3 FRAME 449T NEMA B

TORQUE & CURRENT VS. SPEED

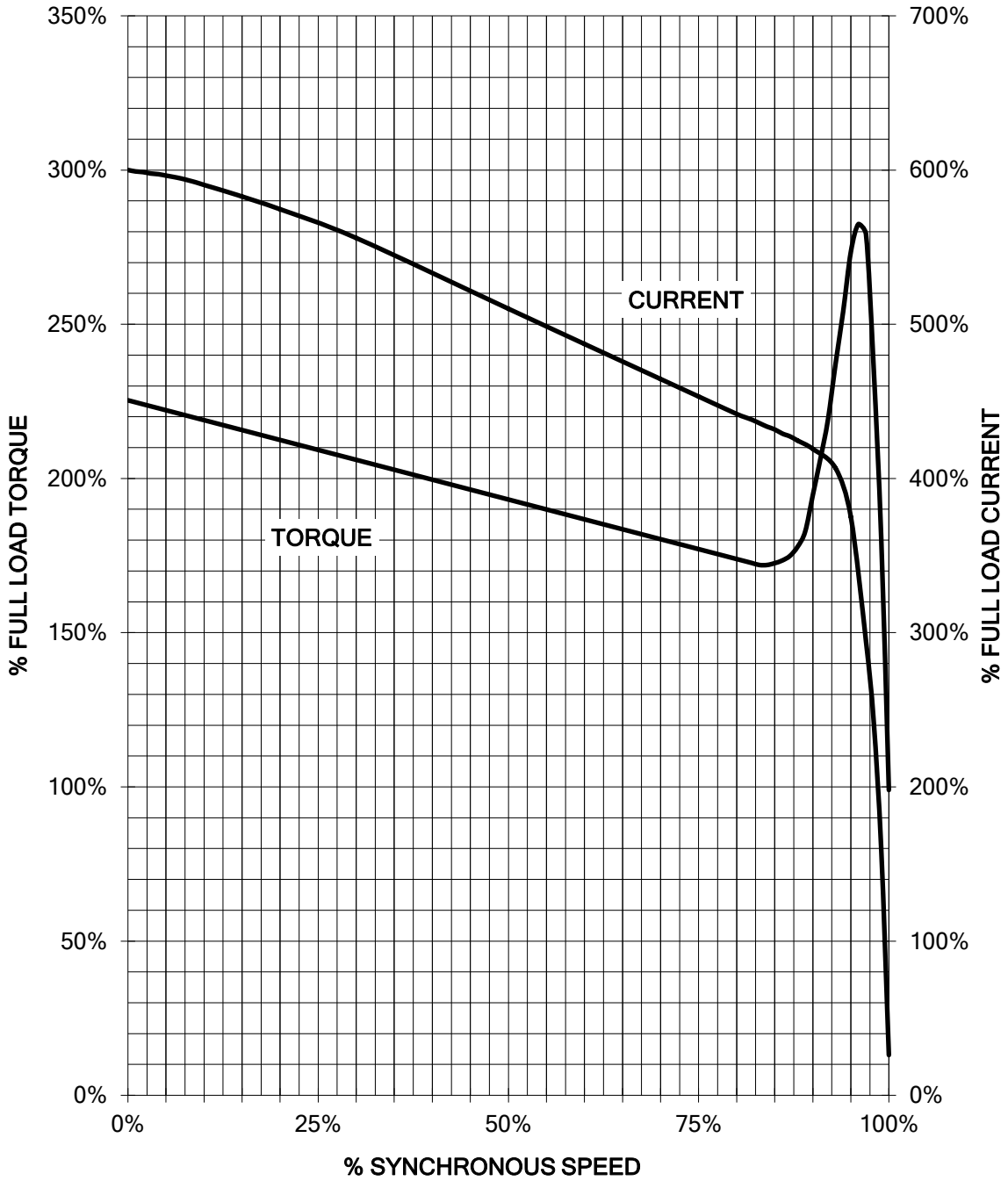

Unrestricted CUSTOMER: _____ ORDER#: _____

Main terminal diagram

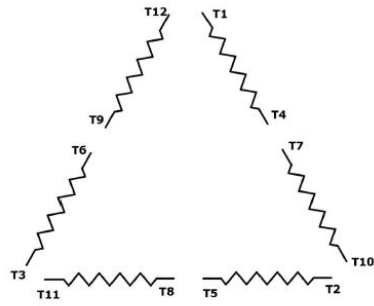

12 LEAD DELTA		
LINES	CONNECT TOGETHER	CONN.
L1	T12 - T7 - T6 - T1	ΔΔ
L2	T10 - T8 - T4 - T2	
L2	T11 - T9 - T5 - T3	

responsible dep. DI MC LVM	technical reference	created by	approved by	Project
SIEMENS	document type Wiring Diagram	document status free		customer
	title 1LE6321-4CB31-2AA1	document number		
© Siemens AG 2019		rev. 01	creation date 12/03/2019	language en
				Page 1/1

300 HP 1800 RPM 449T FRAME 460 VOLTS 3 PHASE NEMA DESIGN B

SIEMENS INDUSTRY, INC.
PERFORMANCE CURVE
SD200

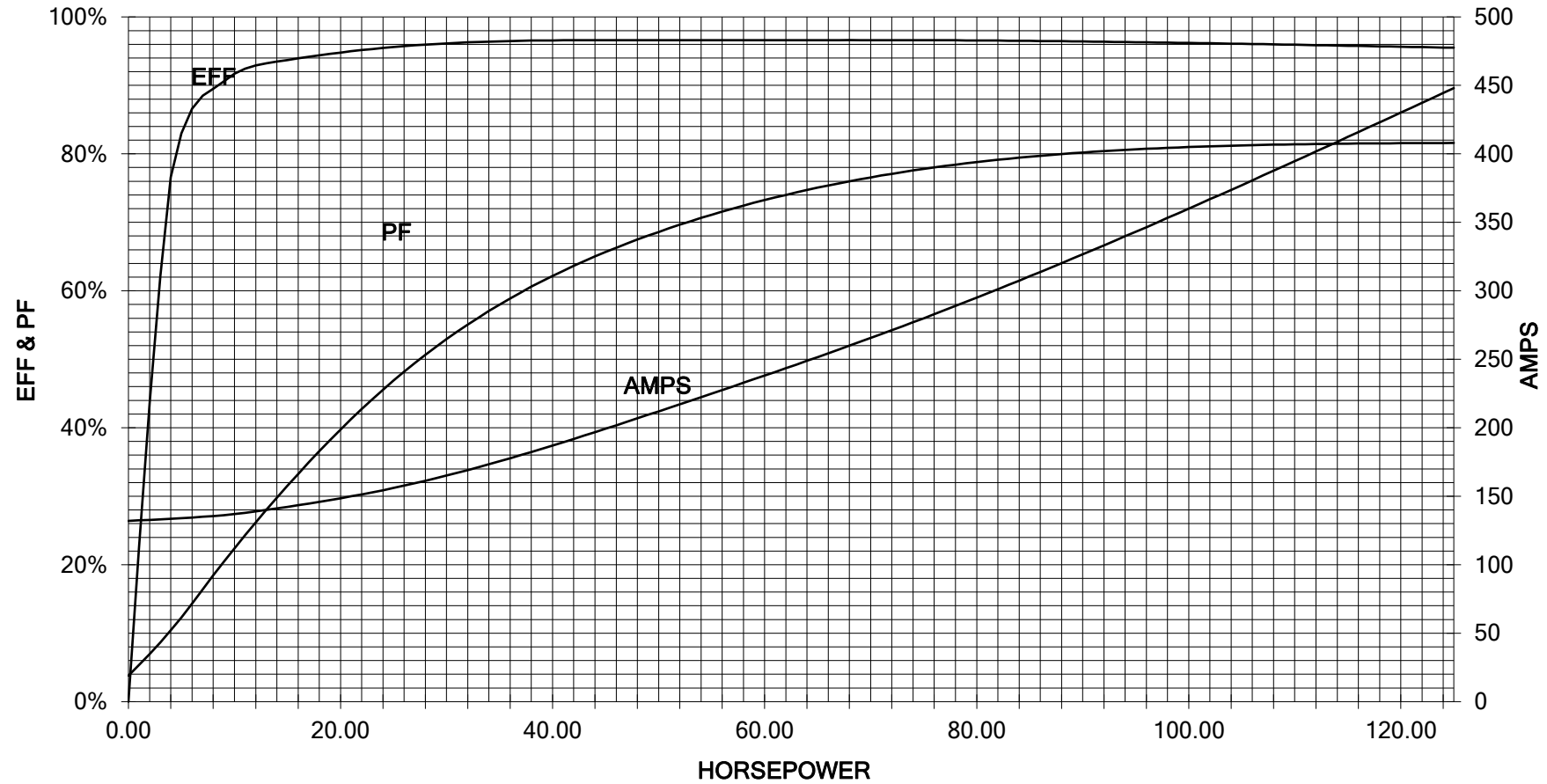

Unrestricted CUSTOMER _____ ORDER # _____ PO # _____

PERFORMANCE BASED ON DESIGN CALCULATIONS. SUBJECT TO CHANGE WITHOUT NOTICE.

REV. 1