

CATALOG No: **BC4N125-5D**

ISSUED: 28-Feb-24

GENERAL INFORMATION

HP	KW	Pole	RPM	Frame	Voltage	Hz	Phase	IP Rating
125	90.00	4	1800	444TD	575 V	60	3	IP55

Enclosure	Ins. Class	Service Factor	Time Rating	NEMA Design	Rated Amb.	Rated Altitude
TEFC	F	1.25	Continuous	B	-15 to 40 C°	<3300 ft

TYPICAL PERFORMANCE

Efficiency (%)			Power Factor (%)		
Full Load	3/4 Load	1/2 Load	Full Load	3/4 Load	1/2 Load
95.4	95.5	95.1	0.85	0.82	0.78

LRT%	BDT %	Full Load Amps	Locked Rotor Amps	Full Load RPM
		575 V	575 V	
200	220	115.20	726.40	1775

NEMA KVA Code	Bearing Size		Oil Seal		Sound Level
	Drive End	Non-Drive End	Drive End	Non-Drive End	dB(A)
G	6316.00	6316.00	90 x 120 x 12	90 x 120 x 12	74

*Weights shown are estimated and based on standard foot mounted motor designs

VFD DUTY INFORMATION

	Variable Torque	Constant Torque	Rating
-	3 - 60 Hz	4 - 60 Hz	CSA Approved Class I; Div 2; Groups A, B, C, & D, T3
-	-	-	

Click Link Below For Drawing

<http://brookcromptonna.com/Drawings/W-NEMA/NEMA%20Cast%20Iron%20B35/WP-DF444TD.pdf>

Click Link Below For Connection Diagram

<http://www.brookcromptonna.com/Connections/Connection%20Diagram%206%20Lead%20575%20NEMA.pdf>

Notes:

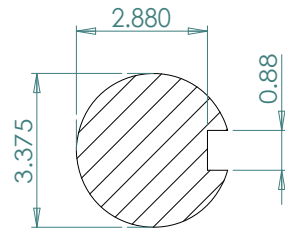
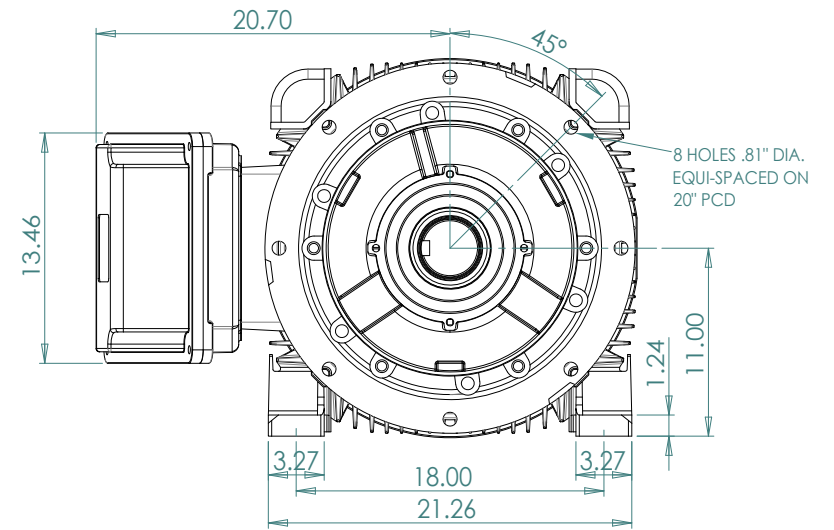
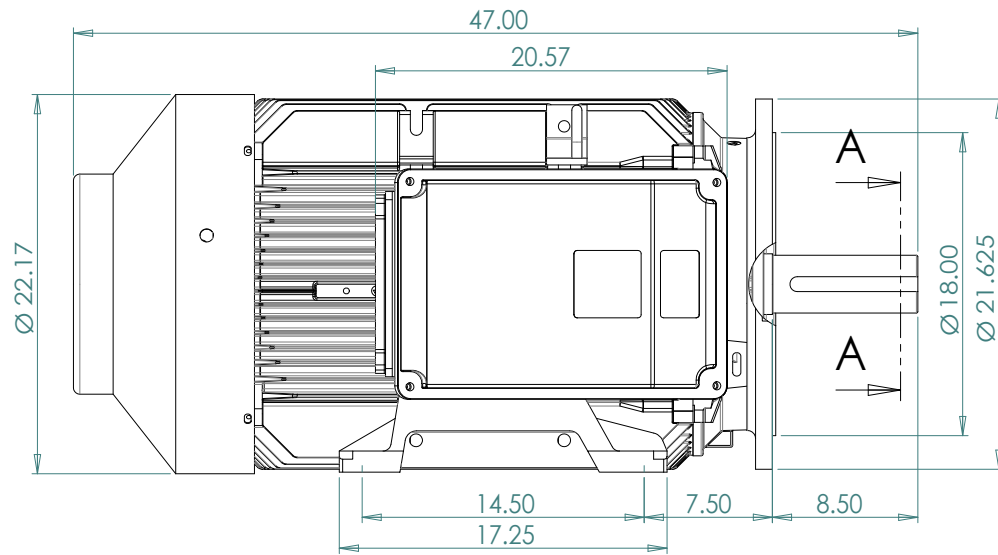

SECTION A-A
SCALE 1:3

BROOK CROMPTON	
WP-DF444TD	A3
SHEET	www.brookcrompton.com