

CATALOG No: **BF4N.75V5**

ISSUED: 14-Mar-24

GENERAL INFORMATION

HP	KW	Pole	RPM	Frame	Voltage	Hz	Phase	IP Rating
0.75	0.55	4	1800	56	575 V	60	3	IP55

Enclosure	Ins. Class	Service Factor	Time Rating	NEMA Design	Rated Amb.	Rated Altitude
TEFC	F	1.25	Continuous	B	-15 to 40 C°	<3300 ft

TYPICAL PERFORMANCE

Efficiency (%)			Power Factor (%)		
Full Load	3/4 Load	1/2 Load	Full Load	3/4 Load	1/2 Load
72.8	73.1	70.5	0.75	0.65	0.52

LRT%	BDT %	Full Load Amps	Locked Rotor Amps	Full Load RPM
		575 V	575 V	
240	270	1.02	4.39	1710

NEMA KVA Code	Bearing Size		Oil Seal		Sound Level
	Drive End	Non-Drive End	Drive End	Non-Drive End	dB(A)
K	6204ZZC3	6003ZZC3	-	-	-

*Weights shown are estimated and based on standard foot mounted motor designs

VFD DUTY INFORMATION

	Variable Torque	Constant Torque	Rating
-	6 - 60 Hz	12 - 60 Hz	CSA Approved Class I; Div 2; Groups A, B, C, & D, T3 With VFD
-	-	-	

Click Link Below For Drawing

<http://brookcrompton.com/Drawings/W%20Premium%20Drawings/Aluminum/Foot%20Mount/WP-DA56T-J2%20B3.pdf>

Click Link Below For Connection Diagram

[Connection Diagram Not Available. Please Call 1-800-MOTORS-9](#)

Notes:

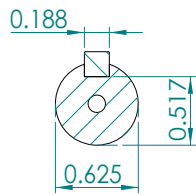
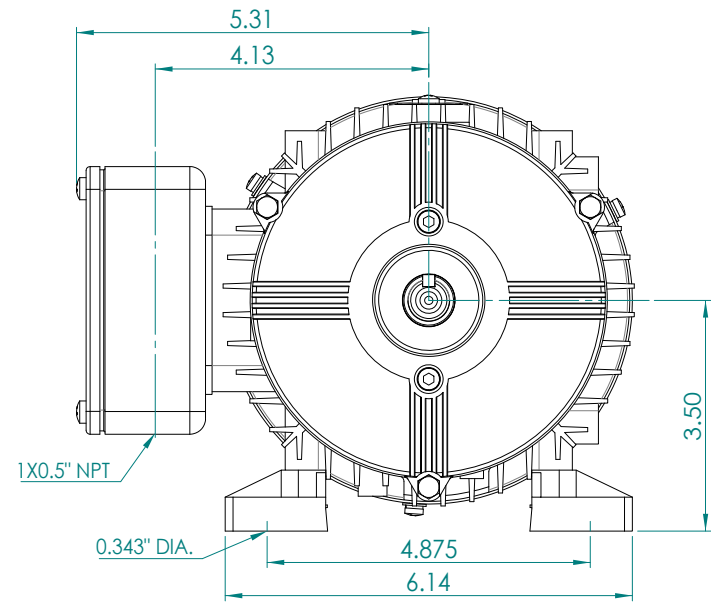
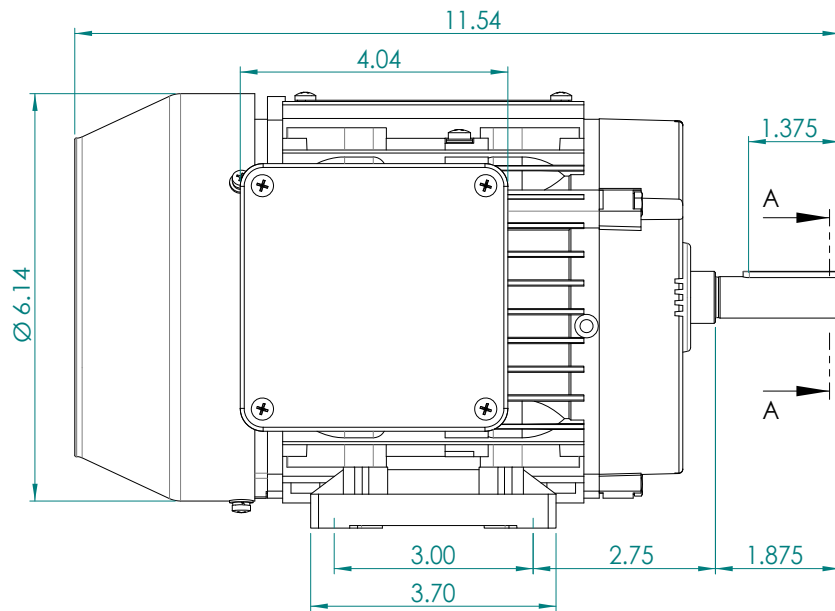

SECTION A-A
SCALE 1 : 1

**BROOK
CROMPTON**

WPN-DA56-V

A3

SHEET

www.brookcrompton.com