

CATALOG No: **BF6N.75V2C**

ISSUED: 14-Mar-24

GENERAL INFORMATION

HP	KW	Pole	RPM	Frame	Voltage	Hz	Phase	IP Rating
0.75	0.55	6	1200	56C	208-230/460 V	60	3	IP55

Enclosure	Ins. Class	Service Factor	Time Rating	NEMA Design	Rated Amb.	Rated Altitude
TEFC	F	1.25	Continuous	B	-15 to 40 C°	<3300 ft

TYPICAL PERFORMANCE

Efficiency (%)			Power Factor (%)		
Full Load	3/4 Load	1/2 Load	Full Load	3/4 Load	1/2 Load
74.7	74.2	71.1	0.68	0.59	0.46

LRT%	BDT %	Full Load Amps	Locked Rotor Amps	Full Load RPM
		460 V	460 V	
300	300	1.36	5.45	1130

NEMA KVA Code	Bearing Size		Oil Seal		Sound Level
	Drive End	Non-Drive End	Drive End	Non-Drive End	dB(A)
K	6204ZZC3	6003ZZC3	-	-	-

*Weights shown are estimated and based on standard foot mounted motor designs

VFD DUTY INFORMATION

	Variable Torque	Constant Torque	Rating
-	6 - 60 Hz	12 - 60 Hz	CSA Approved Class I; Div 2; Groups A, B, C, & D, T3 With VFD
-	-	-	

Click Link Below For Drawing

<http://brookcrompton.com/Drawings/W-NEMA/NEMA%20Aluminum%20B34/WP-DA56C.pdf>

Click Link Below For Connection Diagram

[Connection Diagram Not Available. Please Call 1-800-MOTORS-9](#)

Notes:

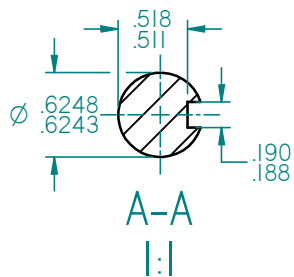
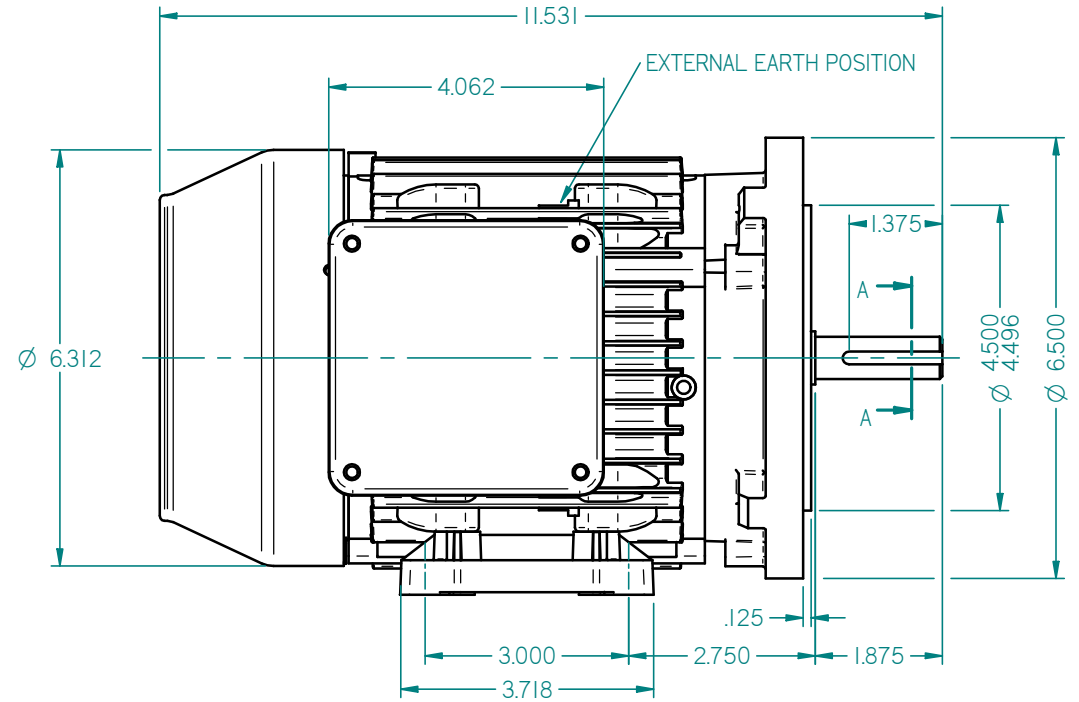
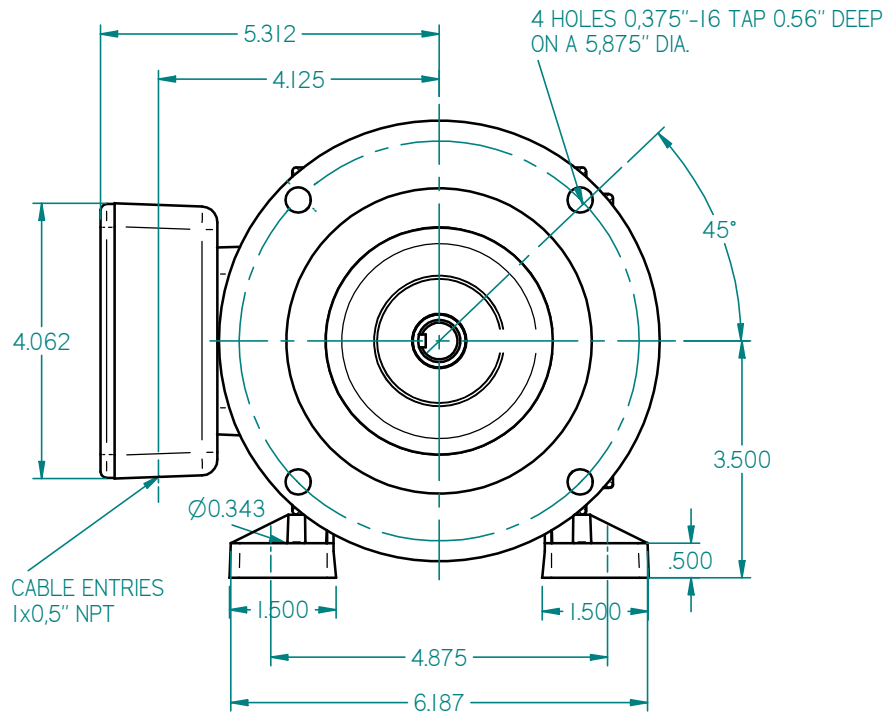

STANDARD TERMINAL BOX POSITION IS 9 O'CLOCK AS SHOWN.
 CONDUIT ENTRIES:- TERMINAL BOX CAN BE ROTATED AT 90° INTERVALS
 (CONDUIT ENTRY POSITION SHOWN FOR ILLUSTRATION ONLY)

ALL DIMENSIONS IN ICHNES



FIRST ANGLE
 PROJECTION

**BROOK
 CROMPTON**

SHEET
 SIZE

A3

TITLE:

OUTLINE DIMENSION DRAWING W ALUMINIUM TOTALLY ENCLOSED FAN COOLED
 WP-DA56C FRAME FOOT& CFLANGE MOUNTED MOTOR

	NAME	DATE
DRAWN	DL	14-03-13
CHECKED		
SCALE	1 : 2	

DRG. No.

DRG. REF.

REVISION:

DATE: