



---

# Customer information packet

## CCPX36726T

75HP, 3555RPM, 3PH, 60HZ, 365TSC, TEFC, F1

Class - CLI GP C,D; CLII GP E,F,G

Division - Division I

## Specifications

Enclosure	TEFC
Frame	365TSC
Frame Material	Iron
Frequency	60.00 Hz
Motor Letter Type	Three Phase
Output @ Frequency	75.000 HP @ 60 HZ
Phase	3
Synchronous Speed @ Frequency	3600 RPM @ 60 HZ
Voltage @ Frequency	230.0 V @ 60 HZ
	460.0 V @ 60 HZ
XP Class and Group	CLI GP C,D; CLII GP E,F,G
XP Division	Division I
Agency Approvals	CCSA US
	CSA
	CSA EEV
	UL
Ambient Temperature	40 °C
Auxillary Box	No Auxillary Box
Base Indicator	Rigid
Bearing Grease Type	Polyrex EM (-20F +300F)
Constant Torque Speed Range	6-60
Current @ Voltage	81.800 A @ 460.0 V
	164.000 A @ 230.0 V
Design Code	B
Drip Cover	No Drip Cover
Duty Rating	CONT
Efficiency @ 100% Load	93.6 %
Enclosure Modification	Severe Duty Features
Feedback Device	NO FEEDBACK
Heater Indicator	No Heater
High Voltage Full Load Amps	81.8 a
Insulation Class	F

## Part detail

Revision	C
Type	AC
Mech. spec.	
Base	
Status	PRD/A
Elec. spec.	A36WG0026
Layout	617428-693
Eff. date	07-02-2021
CD Diagram	416820-002
Poles	02
Leads	3#2,6#4
Proprietary	False
Created date	04-16-2019

<b>Inverter Code</b>	Inverter Ready
<b>IP Rating</b>	IP55
<b>KVA Code</b>	F
<b>Lifting Lugs</b>	Standard Lifting Lugs
<b>Max Speed</b>	4200 rpm
<b>Motor Lead Quantity/Wire Size</b>	3 @ 2 AWG
<b>Motor Standards</b>	NEMA
<b>Motor Type</b>	A36068M
<b>Mounting Arrangement</b>	F1
<b>Number of Poles</b>	2
<b>Overall Length</b>	31.36 IN
<b>Power Factor</b>	92
<b>Product Family</b>	General Industrial
<b>Pulley End Bearing Type</b>	Ball
<b>Pulley Face Code</b>	C-Face
<b>Service Factor</b>	1.00
<b>Shaft Diameter</b>	1.875 IN
<b>Shaft Ground Indicator</b>	No Shaft Grounding
<b>Shaft Rotation</b>	Reversible
<b>Shaft Slinger Indicator</b>	Shaft Slinger
<b>Speed</b>	3555 rpm
<b>Speed Code</b>	Single Speed
<b>Starting Method</b>	Direct on line
<b>Thermal Device - Bearing</b>	None
<b>Thermal Device - Winding</b>	Normally Closed Thermostat
<b>XP Temp Code</b>	T3C

**Nameplate**

<b>NP2496L</b>	
MOBIL POLYREX EM	

---

**000692000FX**

---



---

---

**000613006PC**

---

<b>CLASS I GROUP</b>	C D X	<b>NO.</b>	
<b>CLASS II GROUP</b>	E F G		
<b>OPERATING TEMP CODE</b>	T3C		

---

---

**000901002AAA**

---

SUITABLE FOR 55C AMB AT 1.00 S

F AT SINEWAVE



---

**NP3140L**

<b>SPEC NO.</b>	A36-5002-0026		<b>CAT.NO.</b>	CCPX36726T			<b>FRAME</b>	365TSC	
<b>HP</b>	75	<b>VOLTS</b>	230/460	<b>PHASE</b>	3	<b>DESIGN</b>	B	<b>TYPE</b>	P
<b>RPM</b>	3555	<b>AMPS</b>	164/81.8	<b>HZ</b>	60	<b>AMB</b>	40	<b>SF</b>	1.00
<b>DRIVE END BEARING</b>	65BC03J30X		<b>DUTY</b>	CONT	<b>INSUL.CLASS</b>		F		
<b>OPP D.E. BEARING</b>	65BC03J30X		<b>ENCL</b>	TEFC	<b>CODE</b>	F			
<b>SF</b>	1.15	<b>WK2</b>	8.642	<b>MAG CUR</b>	31/15.5	<b>RPM MAX</b>	4200		
<b>CT HZ</b>	6-60	<b>VT HZ</b>	6-60	<b>CHP HZ</b>	60-70	<b>NEMA-NOM-EFF</b>	93.6		
	IP66								
<b>SER.NO.</b>				<b>MOTOR WEIGHT</b>					



## Parts list

Part number	Description	Quantity
SA368489	SA A36-5002-0026	1.000 ea
RA358004	RA A36-5002-0026	1.000 ea
421948032	LABEL, MYLAR	1.000 ea
NP2496L	MOTOR LUBE NAMEPLATE	1.000 ea
000692000JF	CAUTION LABEL TO PREVENT IGNITION	1.000 ea
000692000VD	LABEL WARNING	1.000 ea
000692000FX	UL LISTED LOGO LABEL 2.53 X 0.75 X .018	1.000 ea
000613006PC	N/P U/L (REL QTY 500)	1.000 ea
000901002AAA	N/P BLANK (RELEASE QTY 1,500)	1.000 ea
NP3140L	INVERTER DUTY, SS, CC, CSA-C US, CSA EEV	1.000 ea
609158001B	SLGR - 360	1.000 ea
603284001S	SLGR - 360	1.000 ea
087793130	BRKT STD 313 E360 FCXP W/ CL.II GRP E &	1.000 ea
415072001B	CLAMP	1.000 ea
415030051AX	BUSH - 360	1.000 ea
078559001A	+FANCV - 360	1.000 ea
034180012DA	KEY 1X4X1/4X1-1/2 L	1.000 ea
HW4505A02	BREATHER/DRAIN-EXP PROOF-.250-18 PTF AIS	1.000 ea
HW4505A02	BREATHER/DRAIN-EXP PROOF-.250-18 PTF AIS	1.000 ea
702676001C	FAN 360	1.000 ea
004824015A	GREASE POLYREX EM	0.540 lb
032018008AK	HHCS 1/4-20X1 PLATED	4.000 ea
032018018CK	HHCS 3/8-16X2-1/4 PLTD.	2.000 ea
415096002A	CPLG 1/8 HEX TYPE	1.000 ea
604923009R	SLGR - 360	1.000 ea
410700004F	WSHR	1.000 ea
034017016AB	LCKW 1/2" PLATED	4.000 ea
034017012AB	LCKW 1/4 STD. PLATED 034017012AF	4.000 ea
032130020DB	HSHCS 1/2-13X2-1/2 PLTD.	4.000 ea
034017014AB	LCKW 3/8 STD. PLATED	2.000 ea
034530056AC	P/NIP 1/8X7L GALV-365	1.000 ea

032620012HD	HSSS 8-32X3/8 304S.S.	2.000 ea
034690002AB	PPLG 1/4" PLTD.	1.000 ea
034690002AB	PPLG 1/4" PLTD.	1.000 ea
087793061CP	BRKT 360 C-FACE	1.000 ea
032018018CK	HHCS 3/8-16X2-1/4 PLTD.	2.000 ea
604923009R	SLGR - 360	1.000 ea
034017016AB	LCKW 1/2" PLATED	4.000 ea
034017014AB	LCKW 3/8 STD. PLATED	2.000 ea
032620012HD	HSSS 8-32X3/8 304S.S.	2.000 ea
415030051AX	BUSH - 360	1.000 ea
032130020DB	HSHCS 1/2-13X2-1/2 PLTD.	4.000 ea
073646000E	C/B 320 WA073646000 KB	1.000 ea
064069000A	C/BC320/360 X 064069000B	1.000 ea
418150003A	GREASE FITTING CAP	1.000 ea
032018014DK	HHCS 1/2-13X1-3/4 PLTD	4.000 ea
063916001DE	+P/NIP 3X2-5/8 DIMPL-360	1.000 ea
034017016AB	LCKW 1/2" PLATED	4.000 ea
035000001A	ALFTG 1/8" 1610-BL	1.000 ea
415000103A	T/LUG #14AWG-#4AWG W/HOLE FOR .250 BOLT	1.000 ea
406099000A	PLUG - FAN COVER 320-440	1.000 ea
032018004AM	HHCS 1/4-20X1/2PLTD GREN	1.000 ea
034036012AB	CKW EXTERNAL TOOTH 1/4"	1.000 ea
035000001A	ALFTG 1/8" 1610-BL	1.000 ea
418150003A	GREASE FITTING CAP	1.000 ea
MG1025G05	WILKOFAS, 789.227, MED. GRAY CHAR. MET.	0.250 ga
033775004EA	DRSCR #6-1/4 304 S.S.	8.000 ea
034180016GA	KEY 1/2X1/2X2 L	1.000 ea
14PA1000	PACKAGING 314 GROUP COMBINED PRINT	1.000 ea
HW1000A32	5/16 FL WASHER WIDE, ID=.344, OD=1.125	3.000 ea
032509020C	CARRIAGE BOLT - 360	3.000 ea

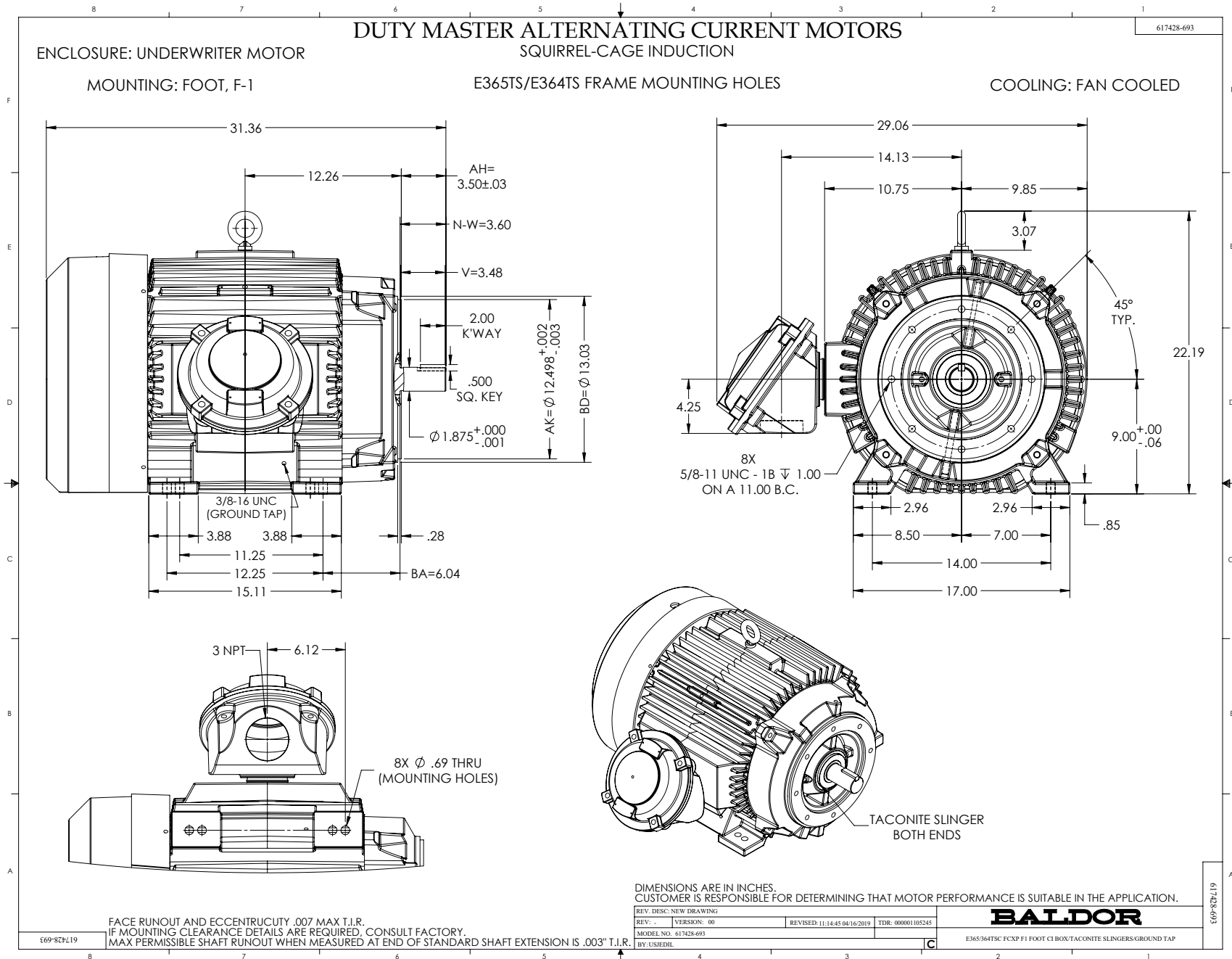

# CONNECTION DIAGRAM ACCESSORIES

MOTOR WINDING THERMOSTATS	
CONTACTS _____ @ _____ °C	
FIGURE NUMBER _____	
CONTACT RATING	
VOLTS	CONTINUOUS AMPERES
110-120	3.0
220-240	1.5
440-480	0.75
550-600	0.60
	INRUSH AMPERES
	30
	15
	7.5
	6.0

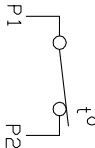
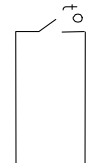
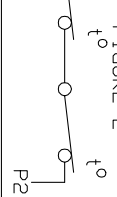
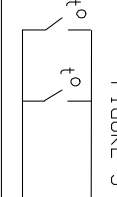
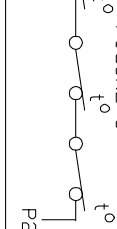
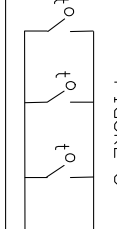
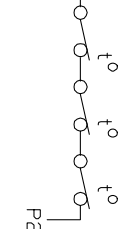
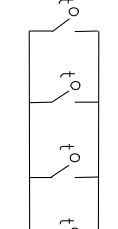
NORMALLY CLOSED	THERMOSTATS	NORMALLY OPEN
 <p>FIGURE 1</p>		 <p>FIGURE 4</p>
 <p>FIGURE 2</p>		 <p>FIGURE 5</p>
 <p>FIGURE 3</p>		 <p>FIGURE 6</p>
 <p>FIGURE 7</p>		 <p>FIGURE 8</p>

CUSTOMER \_\_\_\_\_

CUSTOMER  
ORDER NO. \_\_\_\_\_

S.O. NO. \_\_\_\_\_

418174-006

418174-006

REV. DESC: LOADED TO BUS		
REV. LTR: A	VERSION: 01	TDR: 000000570390
FILE: \RAG\00013\849	REVISED: 10:16:21 12/07/2010	BY: RAGDRF
MTL: -		

**BALDOR**

A-C MOTOR CONNECTION ACCESSORIES

SH 1 of 1

416820-002

A-C MOTOR  
 CONNECTION DIAGRAM  
 STANDARD 9 LEAD DELTA-CONNECTED

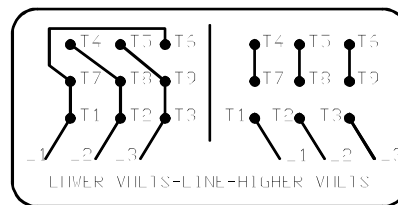
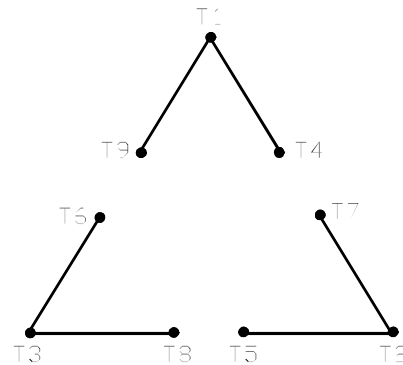

(N.P. 1575-B)

416820-002

REV. DESC: FONT CHANGE FOR PDF SEARCHABLE		
REV. LTR: A	VERSION: 01	TDR: 000001009382
FILE: \MGA\00000\661	REVISED: 02:46:19 02/13/2020	BY: MGHMTT
MTL: -		© □

**BALDOR - RELIANCE®**

CONN DIAG - STANDARD 9 LEAD, DELTA-CONNECTED

SH 1 of 1