

BALDOR® • RELIANCE 

Product Information Packet

CEDM3711T

10HP,3490RPM,3PH,60HZ,215TC,3728M,TEFC,F

Part Detail							
Revision:	H	Status:	PRD/A	Change #:		Proprietary:	No
Type:	AC	Elec. Spec:	37WGS864	CD Diagram:	CD0005	Mfg Plant:	
Mech. Spec:	37N854	Layout:	37LYN854	Poles:	02	Created Date:	04-14-2016
Base:	RG	Eff. Date:	06-24-2021	Leads:	9#14		

Specs			
Catalog Number:	CEDM3711T	Heater Indicator:	No Heater
Enclosure:	TEFC	Insulation Class:	F
Frame:	215TC	Inverter Code:	Inverter Ready
Frame Material:	Steel	KVA Code:	G
Output @ Frequency:	10.000 HP @ 60 HZ	Lifting Lugs:	Standard Lifting Lugs
Synchronous Speed @ Frequency:	3600 RPM @ 60 HZ	Locked Bearing Indicator:	Locked Bearing
Voltage @ Frequency:	460.0 V @ 60 HZ	Motor Lead Quantity/Wire Size:	9 @ 14 AWG
	230.0 V @ 60 HZ	Motor Lead Exit:	Ko Box
XP Class and Group:	None	Motor Lead Termination:	Flying Leads
XP Division:	Not Applicable	Motor Type:	3730M
Agency Approvals:	UR	Mounting Arrangement:	F1
	CSA EEV	Power Factor:	88
	CCSA US	Product Family:	Dirty Duty Plus
Auxillary Box:	No Auxillary Box	Pulley End Bearing Type:	Sealed Bearing
Auxillary Box Lead Termination:	None	Pulley Face Code:	C-Face
Base Indicator:	Rigid	Pulley Shaft Indicator:	Standard
Bearing Grease Type:	Polyrex EM (-20F +300F)	Rodent Screen:	None
Blower:	None	RoHS Status:	ROHS COMPLIANT

Constant Torque Speed Range:	6	Shaft Extension Location:	Pulley End
Current @ Voltage:	11.600 A @ 460.0 V	Shaft Ground Indicator:	No Shaft Grounding
	23.200 A @ 230.0 V	Shaft Rotation:	Reversible
	24.900 A @ 208.0 V	Shaft Slinger Indicator:	No Slinger
Design Code:	B	Speed Code:	Single Speed
Drip Cover:	No Drip Cover	Motor Standards:	NEMA
Duty Rating:	CONT	Starting Method:	Direct on line
Electrically Isolated Bearing:	Not Electrically Isolated	Thermal Device - Bearing:	None
Feedback Device:	NO FEEDBACK	Thermal Device - Winding:	None
Front Face Code:	Standard	Vibration Sensor Indicator:	No Vibration Sensor
Front Shaft Indicator:	None	Winding Thermal 1:	None
		Winding Thermal 2:	None

Nameplate NP3504E										
CAT NO	CEDM3711T									
SPEC.	37N854S864G1						ENCL	TEFC		
FRAME	215TC		HP		10					
VOLTS	230/460									
FLA	23.2/11.6				I.P.	56				
RPM	3490			RPM MAX	5400					
HZ	60		PH	3		CLASS	F			
SER.F.	1.15		DES	B		CC	010A			
NEMA-NOM-EFF	90.2									
RATING	40C AMB-CONT									
DE BRG	6307			ODE BRG	6206					
GREASE	POLYREX EM									
C HP FR	60		C HP TO	90						
CT HZ FROM	6		CT HZ TO	60		VT HZ FROM	6		VT HZ TO	60
SER.NO	50C AT 1.0 SF									

Parts List		
Part Number	Description	Quantity
SA319733	SA 37N854S864G1	1.000 EA
RA307442	RA 37N854S864G1	1.000 EA
HW3200A01	3/8-16X3/4 I-BLT WELDED F/S	1.000 EA
37CB1000A17E	37 KOBX .75 NPT @ 6:00 (E-COAT)	1.000 EA
37GS1016B01	SANTOPRENE KOBX GASKET W/LIP (BLACK)	1.000 EA
51XW2520A12	.25-20 X .75, TAPTITE II, HEX WSHR SLTD	2.000 EA
11XW1032G06	10-32 X .38, TAPTITE II, HEX WSHR SLTD U	1.000 EA
HW3001B01	BRASS CUP WASHER, FOR #10 SCREW	1.000 EA
37EP1100E37EP5	FRONT TEFC 206 BRG W/CLIPPER	1.000 EA
HA4054	SHORT T-DRAIN FITTING, .125" N.P.T.	1.000 EA
HW4606A03	JM CLIPPER/SEAL (LWE-1156-1875-AL44)	1.000 EA
HW4500S33	1/8 NPT STAINLESS #304 SS PLUG	3.000 EA
HW5100A06	W2420-025 WVY WSHR (WB)	1.000 EA
37EP1300B75E	PULLEY 213-5TC ENCL 307 BRG (E-COAT)	1.000 EA
HA4054	SHORT T-DRAIN FITTING, .125" N.P.T.	1.000 EA
HW4606A04	JM CLIPPER/SEAL (LWE-1376-2125-AL45)	1.000 EA
HW4500S33	1/8 NPT STAINLESS #304 SS PLUG	3.000 EA
10XN2520S28	1/4-20X 1 3/4 HEX HD SS X	4.000 EA
XY3118S12	5/16-18 HEX NUT, STAINLESS STEEL	4.000 EA
51XB1214A20	12-14X1.25 HXWSSLD SERTYB	1.000 EA
07FH4011EP5	FH CAST - POWDER COAT PRIMER 5 MILS	1.000 EA
10XN1032S08	10-32X1/2 HEX HEAD S STL	3.000 EA
36CB4518E	36 LIPPED CB LID E-COATING	1.000 EA
37GS1003	1/16 NEOPRENE GASKET-BLACK, CONDUIT BOX	1.000 EA

Parts List (continued)		
Part Number	Description	Quantity
59XN0832S07	8/32 X 7/16 HX WS HD SER X	4.000 EA
HW2502F21	#303 SS,SQ KEY 5/16 X 2.375	1.000 EA
HA7000A02	KEY RETAINER RING, 1 1/8 DIA, 1 3/8 DIA	1.000 EA
MJ5001A02	732 CL SEALANT 3 OZ DIXIE BEARING 289100	0.001 EA
85XU0407S04	4X1/4 U DRIVE PIN STAINLESS	2.000 EA
LB1115N	LABEL,LIFTING DEVICE (ON ROLLS)	1.000 EA
LB1164	LABEL,WARNING AND DRAIN	1.000 EA
MJ5001A23	P.D. GEORGE B-276 AIR DRY VARNISH	0.001 GA
LB1000	LABEL, DIRTY DUTY	1.000 EA
WD1000D21	TRM,T&B #B71M,RING,18-14,.25,NON-INSL	9.000 EA
MJ1000A02	GREASE, MOBIL POLYREX EM - 124047	0.050 LB
MG1500Y02	WILKOPON PRIMER YELLOW	0.010 GA
MG1025L01	WILKOFASFD, 786.04, BLACK	0.010 GA
36FN3000C02SP	EXFN, PLASTIC, 5.25 OD, 1.175 ID	1.000 EA
HA3104S14	300UBOLT 12.125LG SS	4.000 EA
LC0005	CONN.DIA.,TY M,9-LD,DUAL VOLT,REVERSING	1.000 EA
NP3504E	SS DIRTY DUTY PLUS INV UL CSA-C US EEV	1.000 EA
37PA1074	PALLET PACK GRP, PRINT BOX PK1026A06	1.000 EA
MN416A01	TAG-INSTAL-MAINT no wire (2100/bx) 4/22	1.000 EA

AC Induction Motor Performance Data

Record # 55760

Typical performance - not guaranteed values

Winding: 37WGS864-R033		Type: 3730M		Enclosure: TEFC	
Nameplate Data			460 V, 60 Hz: High Voltage Connection		
Rated Output (HP)	10	Full Load Torque	14.94 LB-FT		
Volts	230/460	Start Configuration	direct on line		
Full Load Amps	23.2/11.6	Breakdown Torque	46.1 LB-FT		
R.P.M.	3490	Pull-up Torque	19.3 LB-FT		
Hz	60 Phase	3	Locked-rotor Torque	23.7 LB-FT	
NEMA Design Code	B KVA Code	G	Starting Current	77.3 A	
Service Factor (S.F.)	1.15	No-load Current	3.66 A		
NEMA Nom. Eff.	90.2	Power Factor	88	Line-line Res. @ 25°C	1.05 Ω
Rating - Duty	40C AMB-CONT		Temp. Rise @ Rated Load	78°C	
S.F. Amps			Temp. Rise @ S.F. Load	97°C	
			Locked-rotor Power Factor	33.7	
			Rotor inertia	0.273 LB-FT ²	

Load Characteristics 460 V, 60 Hz, 10 HP

% of Rated Load	25	50	75	100	125	150	S.F.
Power Factor	57	78	85	88	90	89	88
Efficiency	88.6	91.7	91.6	90.6	89.1	87.3	90
Speed	3573	3548	3520	3489	3455	3417	3464
Line amperes	4.56	6.49	8.9	11.6	14.6	17.9	13.5

Performance Graph at 460V, 60Hz, 10.0HP Typical performance - Not guaranteed values

BALDOR ELECTRIC COMPANY

WINDING # 37WGS864

Typical performance - not guaranteed values.

10 HP 3 PH 60 HZ 3490 RPM 460 V 3730M

TORQUES(LB-FT): PO=46.1 PU=19.3 LR=23.7 LRA=77.3

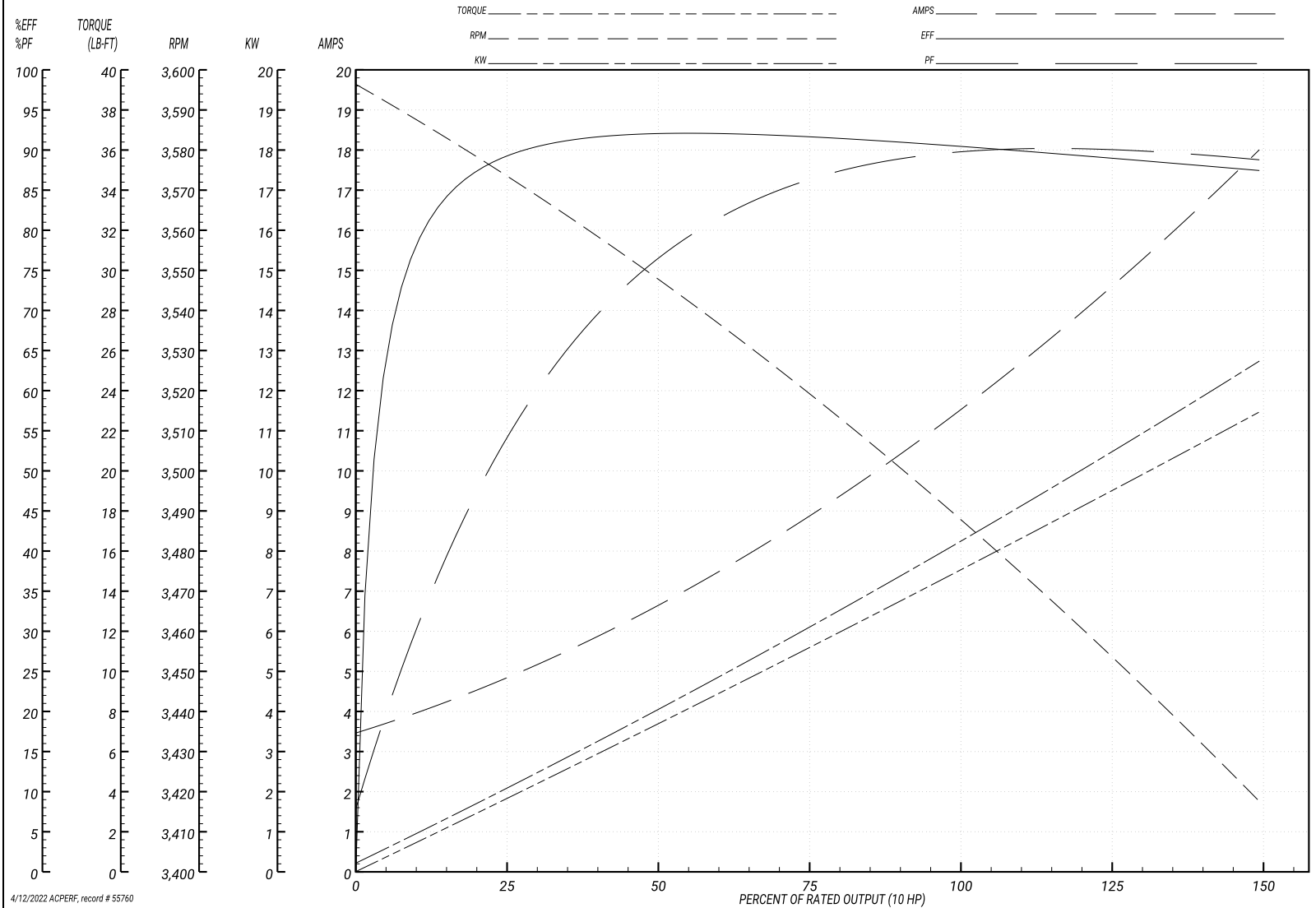

4/12/2022 ACPERF, record # 55760

37LYN854

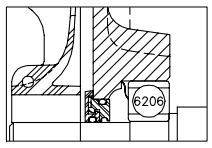
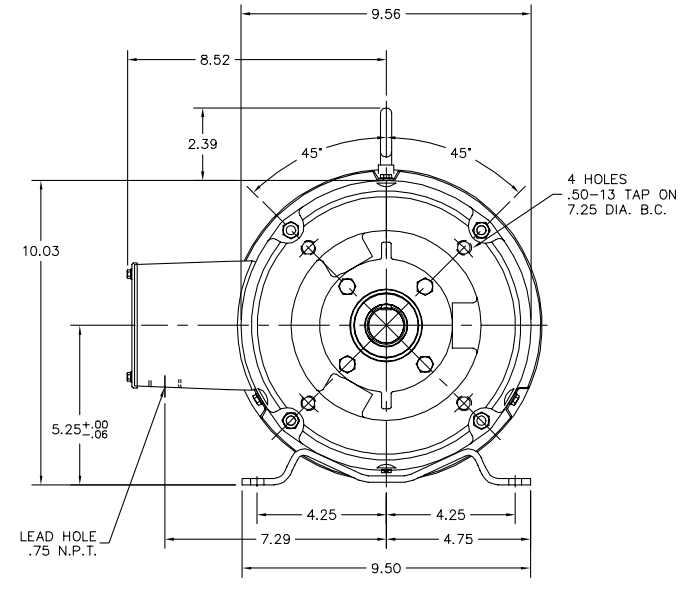
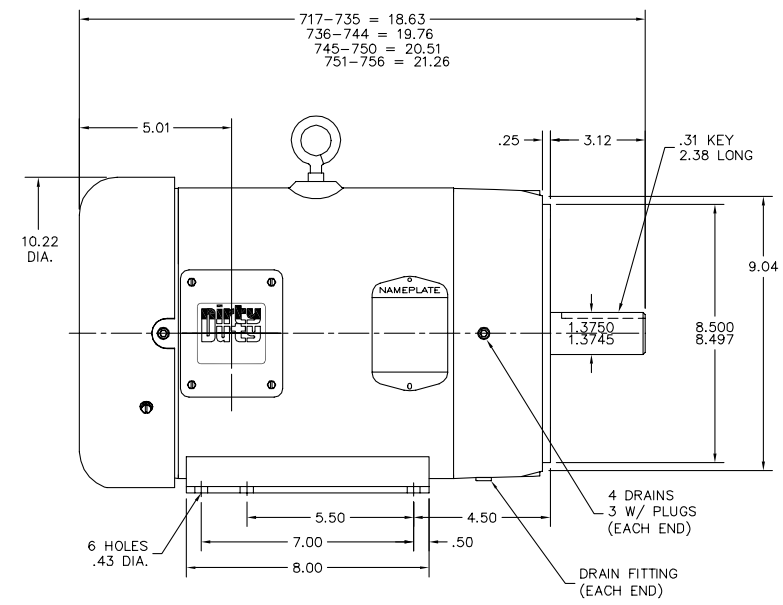

FRONT END DETAIL

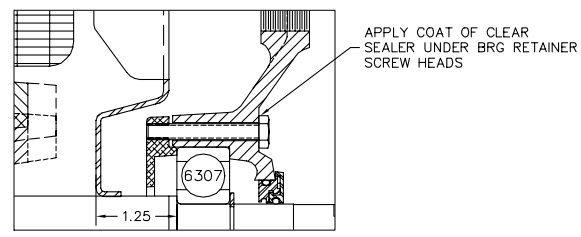

PULLEY END DETAIL

CUSTOMER IS RESPONSIBLE FOR DETERMINING THAT BALDOR'S PRODUCT WILL PERFORM SUITABLY IN THE INTENDED APPLICATION.

REV. DESC: NEW	VERSION: 00	TDR: 000000968673
REV. LTR: -	REvised: 06:38:31 04/14/2016	BY: ENCHALO
FILE: \AAA\00226\145		
MTL: -		

BALDOR
 STD HORZ 213-5TC TEFC 37M DDP
 SH 1 of 1

37LYN854

CD0005

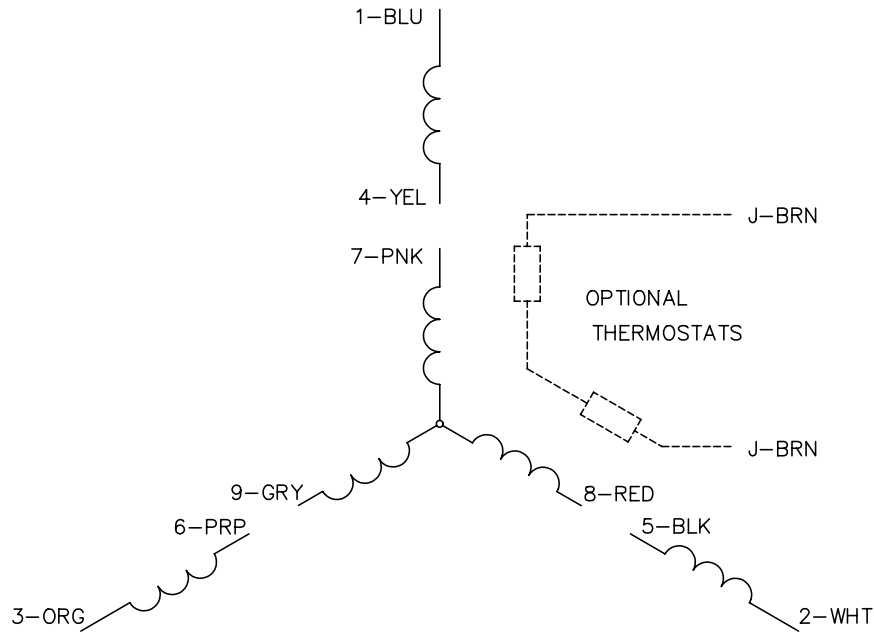

LOW VOLTAGE
(2Y)

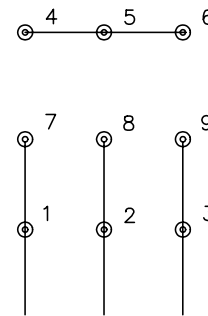

LINE

HIGH VOLTAGE
(1Y)

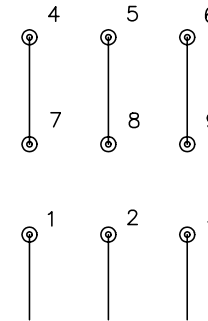

LINE

NOTES:

1. INTERCHANGE ANY TWO LINE LEADS TO REVERSE ROTATION.
2. OPTIONAL THERMOSTATS ARE PROVIDED WHEN SPECIFIED.
3. ACTUAL NUMBER OF INTERNAL PARALLEL CIRCUITS MAY BE A MULTIPLE OF THOSE SHOWN ABOVE.
4. LEAD COLORS ARE OPTIONAL. LEADS MUST ALWAYS BE NUMBERED AS SHOWN.

REV. DESC: REVISE TO SHOW OPTIONAL COLORS			
REV. LTR: E	BY: JLP	REVISED: 01/19/99 10:15	TDR: 0171435
900000		FILE: AAA00005140	MDL: -
		MTL: -	

BALDOR ELECTRIC Co.

3PH, DV, 9 LEADS

CD0005