

BALDOR® • RELIANCE 

Product Information Packet

CEM3708T

5HP, 1165RPM, 3PH, 60HZ, 215TC, 3752M, TEFC, F1

Part Detail							
Revision:	C	Status:	PRD/A	Change #:		Proprietary:	No
Type:	AC	Elec. Spec:	37WGQ067	CD Diagram:	CD0005	Mfg Plant:	
Mech. Spec:	37G814	Layout:	37LYG814	Poles:	06	Created Date:	09-21-2017
Base:	RG	Eff. Date:	07-31-2020	Leads:	9#14		Y

Specs			
Catalog Number:	CEM3708T	Insulation Class:	F
Enclosure:	TEFC	Inverter Code:	Inverter Ready
Frame:	215TC	KVA Code:	K
Frame Material:	Steel	Lifting Lugs:	Standard Lifting Lugs
Output @ Frequency:	5.000 HP @ 60 HZ	Locked Bearing Indicator:	Locked Bearing
Synchronous Speed @ Frequency:	1200 RPM @ 60 HZ	Motor Lead Quantity/Wire Size:	9 @ 14 AWG
Voltage @ Frequency:	460.0 V @ 60 HZ	Motor Lead Exit:	Ko Box
	230.0 V @ 60 HZ	Motor Lead Termination:	Flying Leads
XP Class and Group:	None	Motor Type:	3752M
XP Division:	Not Applicable	Mounting Arrangement:	F1
Agency Approvals:	UR	Power Factor:	71
	CSA EEV	Product Family:	General Purpose
	CSA	Pulley End Bearing Type:	Ball
Auxillary Box:	No Auxillary Box	Pulley Face Code:	C-Face
Auxillary Box Lead Termination:	None	Pulley Shaft Indicator:	Standard
Base Indicator:	Rigid	Rodent Screen:	None
Bearing Grease Type:	Polyrex EM (-20F +300F)	RoHS Status:	ROHS COMPLIANT
Blower:	None	Shaft Extension Location:	Pulley End

Current @ Voltage:	14.400 A @ 230.0 V	Shaft Ground Indicator:	No Shaft Grounding
	15.600 A @ 208.0 V	Shaft Rotation:	Reversible
	7.200 A @ 460.0 V	Shaft Slinger Indicator:	No Slinger
Design Code:	A	Speed Code:	Single Speed
Drip Cover:	No Drip Cover	Motor Standards:	NEMA
Duty Rating:	CONT	Starting Method:	Direct on line
Electrically Isolated Bearing:	Not Electrically Isolated	Thermal Device - Bearing:	None
Feedback Device:	NO FEEDBACK	Thermal Device - Winding:	None
Front Face Code:	Standard	Vibration Sensor Indicator:	No Vibration Sensor
Front Shaft Indicator:	None	Winding Thermal 1:	None
Heater Indicator:	No Heater	Winding Thermal 2:	None

Nameplate NP3441LUA

CAT.NO.	CEM3708T				
SPEC	37G814Q067G1				
HP	5				
VOLTS	230/460				
AMPS	14.4/7.2				
RPM	1165				
FRAME	215TC	HZ	60	PH	3
SF	1.15	CODE	K	DES	A
NEMA NOM. EFF	89.5	PF	71	CLASS	F
RATING	40C AMB-CONT				
CC	010A	USABLE AT 208V			15.6
ENCL	TEFC	SER			
DE	6307	ODE	6206		
VPWM INVERTER READY					
CT6-60H(10:1)VT3-60H(20:1)					

Parts List		
Part Number	Description	Quantity
SA345173	SA 37G814Q067G1	1.000 EA
RA333647	RA 37G814Q067G1	1.000 EA
37FN3002C01	EXFN, PLASTIC, 6.00 OD, 1.155 ID	1.000 EA
HW3200A01	3/8-16X3/4 I-BLT WELDED F/S	1.000 EA
37CB3006	37 CB CASTING W/1.38 LEAD HOLE @ 6:00	1.000 EA
37GS1000SP	GASKET, CONDUIT BOX STD., .06 THICK LEXI	1.000 EA
51XW2520A12	.25-20 X .75, TAPTITE II, HEX WSHR SLTD	2.000 EA
11XW1032G06	10-32 X .38, TAPTITE II, HEX WSHR SLTD U	1.000 EA
37EP3101A01	FR ENDPLATE, FOR ROUTING PURPOSES	1.000 EA
HW4500A01	1641B(ALEMITE)400 UNIV, GREASE FITT	1.000 EA
HW5100A06	W2420-025 WVY WSHR (WB)	1.000 EA
37PE3300A01	PUEP ASSEMBLY FOR ROUTING	1.000 EA
HW4500A01	1641B(ALEMITE)400 UNIV, GREASE FITT	1.000 EA
10XN2520A30	HEX HD CAP SCREW-STD THD-.25 X 20 THD PE	4.000 EA
HW1001A25	LOCKWASHER 1/4, ZINC PLT .493 OD, .255 I	4.000 EA
XY3118A12	5/16-18 HEX NUT DIRECTIONAL SERRATION	4.000 EA
51XB1214A20	12-14X1.25 HXWSSLD SERTYB	1.000 EA
07FH4007SP	PRIMED	1.000 EA
51XW1032A06	10-32 X .38, TAPTITE II, HEX WSHR SLTD S	3.000 EA
37CB4516	LIPPED LID FOR 37 FRAME NEC KOBX	1.000 EA
37GS1008	37 GS FOR CB LID - LEXIDE	1.000 EA
51XW0832A07	8-32 X .44, TAPTITE II, HEX WSHR SLTD SE	4.000 EA
HW2501F21	KEY, 5/16 SQ X 2.375	1.000 EA
HA7000A02	KEY RETAINER RING, 1 1/8 DIA, 1 3/8 DIA	1.000 EA

Parts List (continued)		
Part Number	Description	Quantity
85XU0407S04	4X1/4 U DRIVE PIN STAINLESS	2.000 EA
LB1115N	LABEL,LIFTING DEVICE (ON ROLLS)	1.000 EA
MJ1000A02	GREASE, MOBIL POLYREX EM - 124047	0.050 LB
HA3104A25	THRUBOLT .31-18 X 14.75	4.000 EA
MG1000Y03	MUNSELL 2.53Y 6.70/ 4.60, GLOSS 20,	0.028 GA
LC0005E01	CONN.DIA./WARNING LABEL (LC0005/LB1119N)	1.000 EA
NP3441LUA	ALUM SUPER-E VPWM INV READY UL CSA-EEV C	1.000 EA
37PA1074	PALLET PACK GRP, PRINT BOX PK1026A06	1.000 EA
MN416A01	TAG-INSTAL-MAINT no wire (2100/bx) 4/22	1.000 EA

AC Induction Motor Performance Data

Record # 67641

Typical performance - not guaranteed values

Winding: 37WGQ067-R001		Type: 3752M		Enclosure: TEFC		
Nameplate Data			460 V, 60 Hz: High Voltage Connection			
Rated Output (HP)	5	Full Load Torque	22.48 LB-FT			
Volts	230/460	Start Configuration	direct on line			
Full Load Amps	14.4/7.2	Breakdown Torque	80.1 LB-FT			
R.P.M.	1165	Pull-up Torque	51.2 LB-FT			
Hz	60 Phase	3	Locked-rotor Torque	55.8 LB-FT		
NEMA Design Code	A KVA Code	K	Starting Current	54.4 A		
Service Factor (S.F.)	1.15	No-load Current	3.98 A			
NEMA Nom. Eff.	89.5 Power Factor	71	Line-line Res. @ 25°C	3.6757 Ω		
Rating - Duty	40C AMB-CONT	Temp. Rise @ Rated Load	59°C			
S.F. Amps		Temp. Rise @ S.F. Load	73°C			
		Locked-rotor Power Factor	21.9			

Load Characteristics 460 V, 60 Hz, 5 HP

% of Rated Load	25	50	75	100	125	150	S.F.
Power Factor	33	52	64	70	74	76	72
Efficiency	84.4	89.3	90.2	89.7	88.6	87.1	89
Speed	1191.6	1183.1	1174.9	1164.8	1154	1141.3	1158
Line amperes	4.28	5.07	6.08	7.39	8.87	10.6	8.28

Performance Graph at 460V, 60Hz, 5.0HP Typical performance - Not guaranteed values

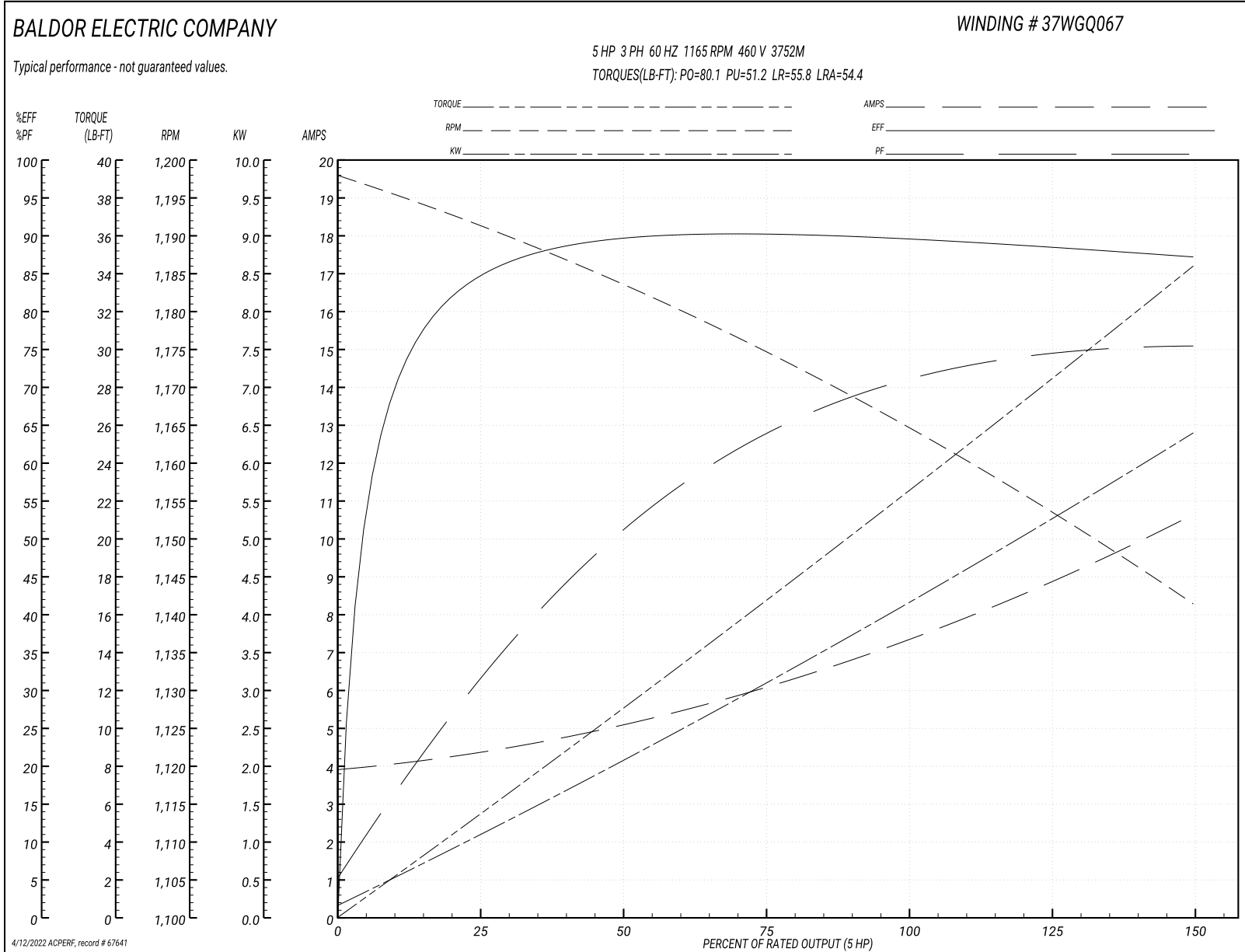

37LYG814

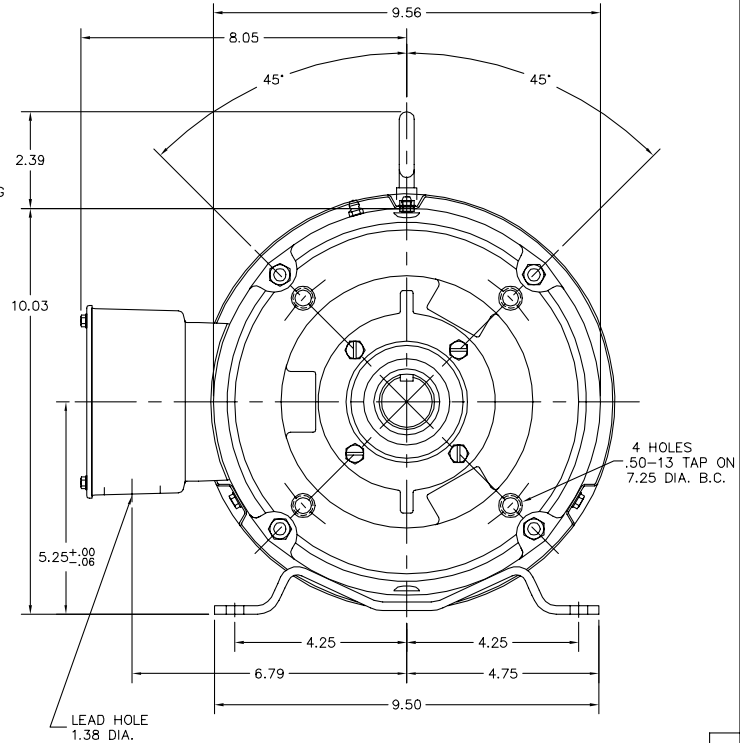
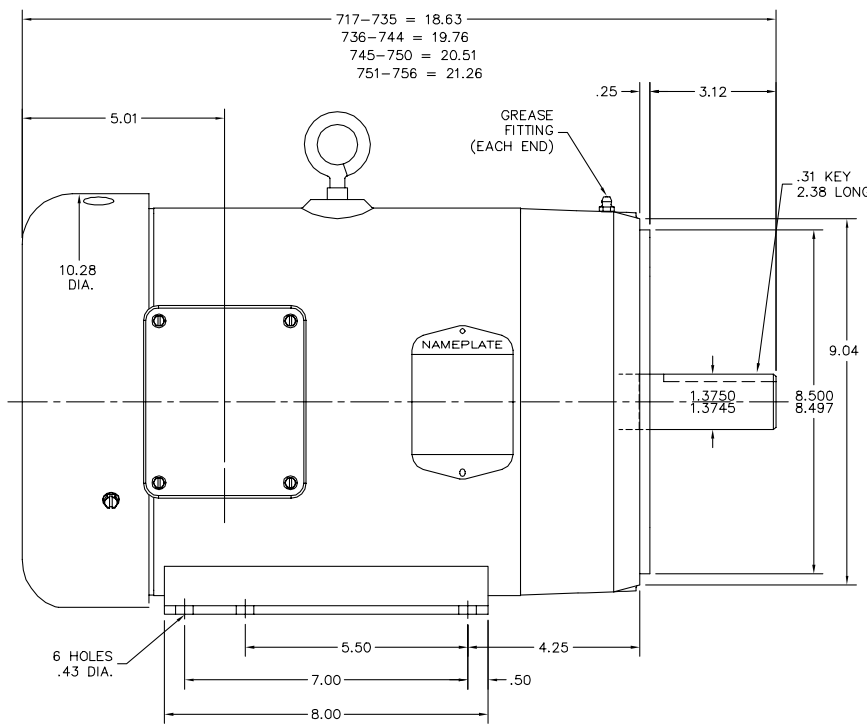

37LYG814

CUSTOMER IS RESPONSIBLE FOR DETERMINING THAT BALDOR'S PRODUCT WILL PERFORM SUITABLY IN THE INTENDED APPLICATION.

REV. DESC: UPDATE LAYOUT GRAPHICS - NO DIM CHANGES		
REV. LTR: D	VERSION: 01	TDR: 000000859468
FILE: \AAA\00051\948	REVISED: 11:08:35 06/24/2014	BY: ENBRAMO
MTL: -		

BALDOR

STD HORZ 213-5TC TEFC 37M W/EPACT SHOVE

SH 1 of 1

CD0005



LOW VOLTAGE
(2Y)



LINE

HIGH VOLTAGE
(1Y)



LINE

NOTES:

1. INTERCHANGE ANY TWO LINE LEADS TO REVERSE ROTATION.
2. OPTIONAL THERMOSTATS ARE PROVIDED WHEN SPECIFIED.
3. ACTUAL NUMBER OF INTERNAL PARALLEL CIRCUITS MAY BE A MULTIPLE OF THOSE SHOWN ABOVE.
4. LEAD COLORS ARE OPTIONAL. LEADS MUST ALWAYS BE NUMBERED AS SHOWN.

REV. DESC: REVISE TO SHOW OPTIONAL COLORS			
REV. LTR: E	BY: JLP	REVISED: 01/19/99 10:15	TDR: 0171435
900000		FILE: AAA00005140	MDL: -
		MTL: -	

BALDOR ELECTRIC Co.

3PH, DV, 9 LEADS

CD0005