

BALDOR® • RELIANCE 

Product Information Packet

CEM3713T

15HP,3500RPM,3PH,60HZ,215TC,3752M,TEFC,F

Part Detail							
Revision:	L	Status:	PRD/A	Change #:		Proprietary:	No
Type:	AC	Elec. Spec:	37WGR228	CD Diagram:	CD0180	Mfg Plant:	
Mech. Spec:	37G814	Layout:	37LYG814	Poles:	02	Created Date:	03-01-2012
Base:	RG	Eff. Date:	07-31-2020	Leads:	9#14		

Specs			
Catalog Number:	CEM3713T	Heater Indicator:	No Heater
Enclosure:	TEFC	Insulation Class:	F
Frame:	215TC	Inverter Code:	Inverter Ready
Frame Material:	Steel	KVA Code:	J
Output @ Frequency:	15.000 HP @ 60 HZ	Lifting Lugs:	Standard Lifting Lugs
Synchronous Speed @ Frequency:	3600 RPM @ 60 HZ	Locked Bearing Indicator:	Locked Bearing
Voltage @ Frequency:	460.0 V @ 60 HZ	Motor Lead Quantity/Wire Size:	9 @ 14 AWG
	230.0 V @ 60 HZ	Motor Lead Exit:	Ko Box
XP Class and Group:	None	Motor Lead Termination:	Flying Leads
XP Division:	Not Applicable	Motor Type:	3752M
Agency Approvals:	UR	Mounting Arrangement:	F1
	CSA EEV	Power Factor:	89
	CSA	Product Family:	General Purpose
Auxillary Box:	No Auxillary Box	Pulley End Bearing Type:	Ball
Auxillary Box Lead Termination:	None	Pulley Face Code:	C-Face
Base Indicator:	Rigid	Pulley Shaft Indicator:	Standard
Bearing Grease Type:	Polyrex EM (-20F +300F)	Rodent Screen:	None
Blower:	None	Shaft Extension Location:	Pulley End

Current @ Voltage:	17.000 A @ 460.0 V	Shaft Ground Indicator:	No Shaft Grounding
	34.000 A @ 230.0 V	Shaft Rotation:	Reversible
	36.800 A @ 208.0 V	Shaft Slinger Indicator:	No Slinger
Design Code:	A	Speed Code:	Single Speed
Drip Cover:	No Drip Cover	Motor Standards:	NEMA
Duty Rating:	CONT	Starting Method:	Direct on line
Electrically Isolated Bearing:	Not Electrically Isolated	Thermal Device - Bearing:	None
Feedback Device:	NO FEEDBACK	Thermal Device - Winding:	None
Front Face Code:	Standard	Vibration Sensor Indicator:	No Vibration Sensor
Front Shaft Indicator:	None	Winding Thermal 1:	None
		Winding Thermal 2:	None

Nameplate NP3441LUA

CAT.NO.	CEM3713T							
SPEC	37G814R228G1							
HP	15							
VOLTS	230/460							
AMPS	34/17							
RPM	3500							
FRAME	215TC		HZ	60		PH	3	
SF	1.15		CODE	J	DES	A	CLASS	F
NEMA NOM. EFF	91		PF	89				
RATING	40C AMB-CONT							
CC	010A		USABLE AT 208V			36.8		
ENCL	TEFC		SER					
DE	6307		ODE	6206				
VPWM INVERTER READY								
CT6-60H(10:1)VT3-60H(20:1)								
	50Hz 15HP 190/380V 40.8/20.4A							
	SF1.0							

Parts List		
Part Number	Description	Quantity
SA240450	SA 37G814R228G1	1.000 EA
RA227368	RA 37G814R228G1	1.000 EA
37FN3002B01	EXFN, PLASTIC, 7.50 OD, 1.155 ID	1.000 EA
HW3200A01	3/8-16X3/4 I-BLT WELDED F/S	1.000 EA
37CB3006	37 CB CASTING W/1.38 LEAD HOLE @ 6:00	1.000 EA
37GS1000SP	GASKET, CONDUIT BOX STD., .06 THICK LEXI	1.000 EA
51XW2520A12	.25-20 X .75, TAPTITE II, HEX WSHR SLTD	2.000 EA
11XW1032G06	10-32 X .38, TAPTITE II, HEX WSHR SLTD U	1.000 EA
37EP3101A01	FR ENDPLATE, FOR ROUTING PURPOSES	1.000 EA
HW4500A01	1641B(ALEMITE)400 UNIV, GREASE FITT	1.000 EA
HW5100A06	W2420-025 WVY WSHR (WB)	1.000 EA
37PE3300A01	PUEP ASSEMBLY FOR ROUTING	1.000 EA
HW4500A01	1641B(ALEMITE)400 UNIV, GREASE FITT	1.000 EA
10XN2520A30	HEX HD CAP SCREW-STD THD-.25 X 20 THD PE	4.000 EA
HW1001A25	LOCKWASHER 1/4, ZINC PLT .493 OD, .255 I	4.000 EA
XY3118A12	5/16-18 HEX NUT DIRECTIONAL SERRATION	4.000 EA
51XB1214A20	12-14X1.25 HXWSSLD SERTYB	1.000 EA
07FH4007SP	PRIMED	1.000 EA
51XW1032A06	10-32 X .38, TAPTITE II, HEX WSHR SLTD S	3.000 EA
37CB4516	LIPPED LID FOR 37 FRAME NEC KOBX	1.000 EA
37GS1008	37 GS FOR CB LID - LEXIDE	1.000 EA
51XW0832A07	8-32 X .44, TAPTITE II, HEX WSHR SLTD SE	4.000 EA
HW2501F21	KEY, 5/16 SQ X 2.375	1.000 EA
HA7000A02	KEY RETAINER RING, 1 1/8 DIA, 1 3/8 DIA	1.000 EA

Parts List (continued)		
Part Number	Description	Quantity
85XU0407S04	4X1/4 U DRIVE PIN STAINLESS	2.000 EA
LB1115N	LABEL,LIFTING DEVICE (ON ROLLS)	1.000 EA
MJ1000A02	GREASE, MOBIL POLYREX EM - 124047	0.050 LB
HA3104A25	THRUBOLT .31-18 X 14.75	4.000 EA
MG1000Y03	MUNSELL 2.53Y 6.70/ 4.60, GLOSS 20,	0.028 GA
LB1119N	WARNING LABEL	1.000 EA
LC0181	CONNECTION LABEL	1.000 EA
NP3441LUA	ALUM SUPER-E VPWM INV READY UL CSA-EEV C	1.000 EA
37PA1074	PALLET PACK GRP, PRINT BOX PK1026A06	1.000 EA
MN416A01	TAG-INSTAL-MAINT no wire (2100/bx) 4/22	1.000 EA

AC Induction Motor Performance Data

Record # 53380

Typical performance - not guaranteed values

Winding: 37WGR228-R023		Type: 3752M		Enclosure: TEFC	
Nameplate Data			460 V, 60 Hz: High Voltage Connection		
Rated Output (HP)	15	Full Load Torque	22.12 LB-FT		
Volts	230/460	Start Configuration	direct on line		
Full Load Amps	34/17	Breakdown Torque	103 LB-FT		
R.P.M.	3500	Pull-up Torque	40.16 LB-FT		
Hz	60 Phase	3	Locked-rotor Torque	57.59 LB-FT	
NEMA Design Code	A KVA Code	J	Starting Current	150 A	
Service Factor (S.F.)	1.15	No-load Current	5.55 A		
NEMA Nom. Eff.	91 Power Factor	89	Line-line Res. @ 25°C	0.47 Ω	
Rating - Duty	40C AMB-CONT	Temp. Rise @ Rated Load	68°C		
S.F. Amps		Temp. Rise @ S.F. Load	79°C		
		Locked-rotor Power Factor	30.9		
		Rotor inertia	0.474 LB-FT ²		

Load Characteristics 460 V, 60 Hz, 15 HP

% of Rated Load	25	50	75	100	125	150	S.F.
Power Factor	56	78	85	89	90	90	89
Efficiency	86.8	91	91.9	91.4	90.8	89.8	91.3
Speed	3579	3557	3534	3500	3484	3456	3495
Line amperes	6.7	9.57	13.19	17.03	21.12	25.61	19.5

Performance Graph at 460V, 60Hz, 15.0HP Typical performance - Not guaranteed values

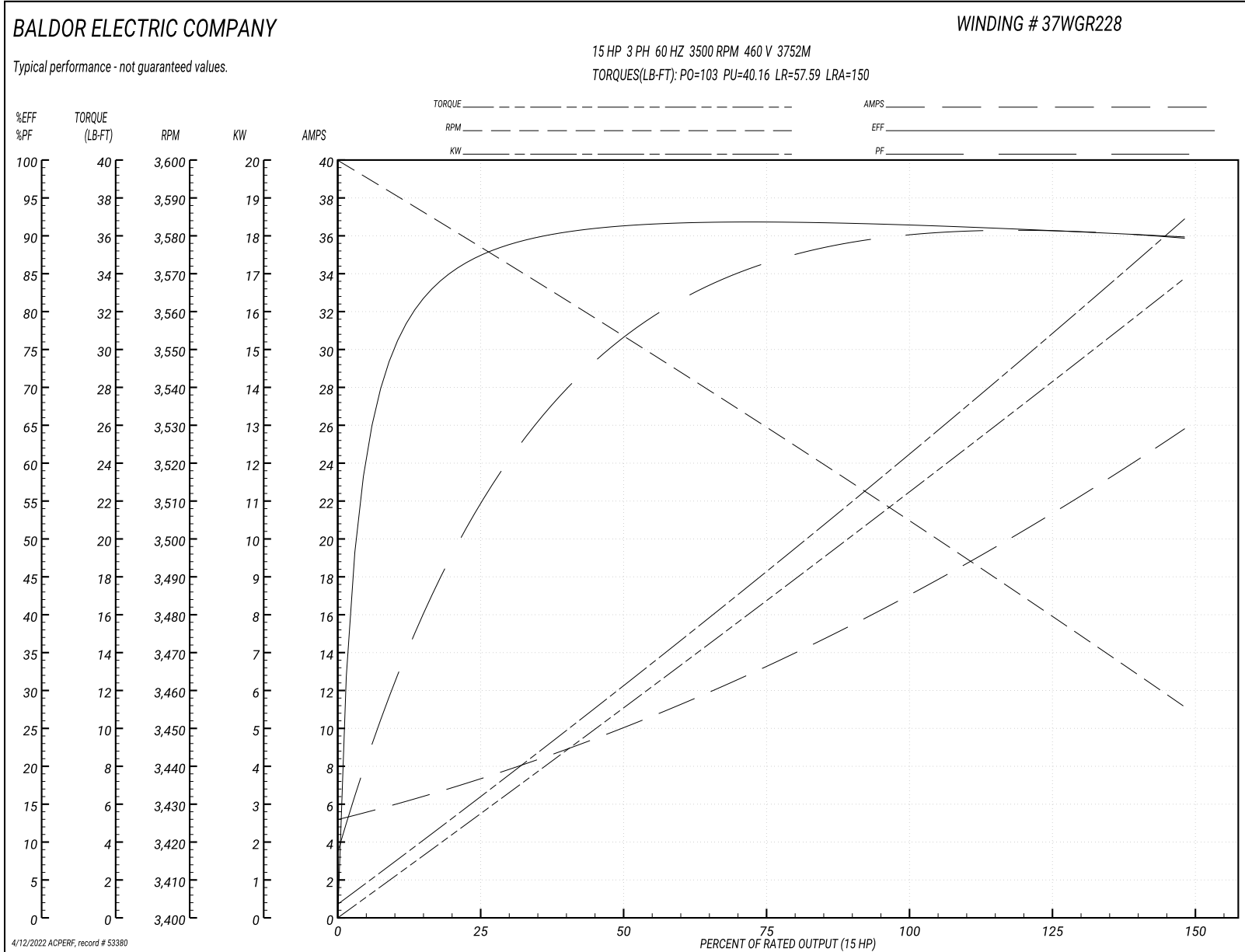

AC Induction Motor Performance Data

Record # 57899

Typical performance - not guaranteed values

Winding: 37WGR228-R023		Type: 3752M		Enclosure: TEFC	
Nameplate Data			230 V, 60 Hz: Low Voltage Connection		
Rated Output (HP)	15	Full Load Torque	22.1 LB-FT		
Volts	230/460	Start Configuration	direct on line		
Full Load Amps	34/17	Breakdown Torque	104 LB-FT		
R.P.M.	3500	Pull-up Torque	40.3 LB-FT		
Hz	60 Phase	3	Locked-rotor Torque	57.8 LB-FT	
NEMA Design Code	A KVA Code	J	Starting Current	300 A	
Service Factor (S.F.)	1.15	No-load Current	11.1 A		
NEMA Nom. Eff.	91 Power Factor	89	Line-line Res. @ 25°C	0.111 Ω	
Rating - Duty	40C AMB-CONT	Temp. Rise @ Rated Load	67°C		
S.F. Amps		Temp. Rise @ S.F. Load	82°C		
		Locked-rotor Power Factor	30.3		
		Rotor inertia	0.474 LB-FT ²		

Load Characteristics 230 V, 60 Hz, 15 HP

% of Rated Load	25	50	75	100	125	150	S.F.
Power Factor	56	77	85	89	90	90	90
Efficiency	86.8	91.1	92	91.8	91	90	91.3
Speed	3579	3558	3534	3510	3485	3456	3495
Line amperes	13.4	19.1	26.4	34	42.2	51.2	38.9

Performance Graph at 230V, 60Hz, 15.0HP Typical performance - Not guaranteed values

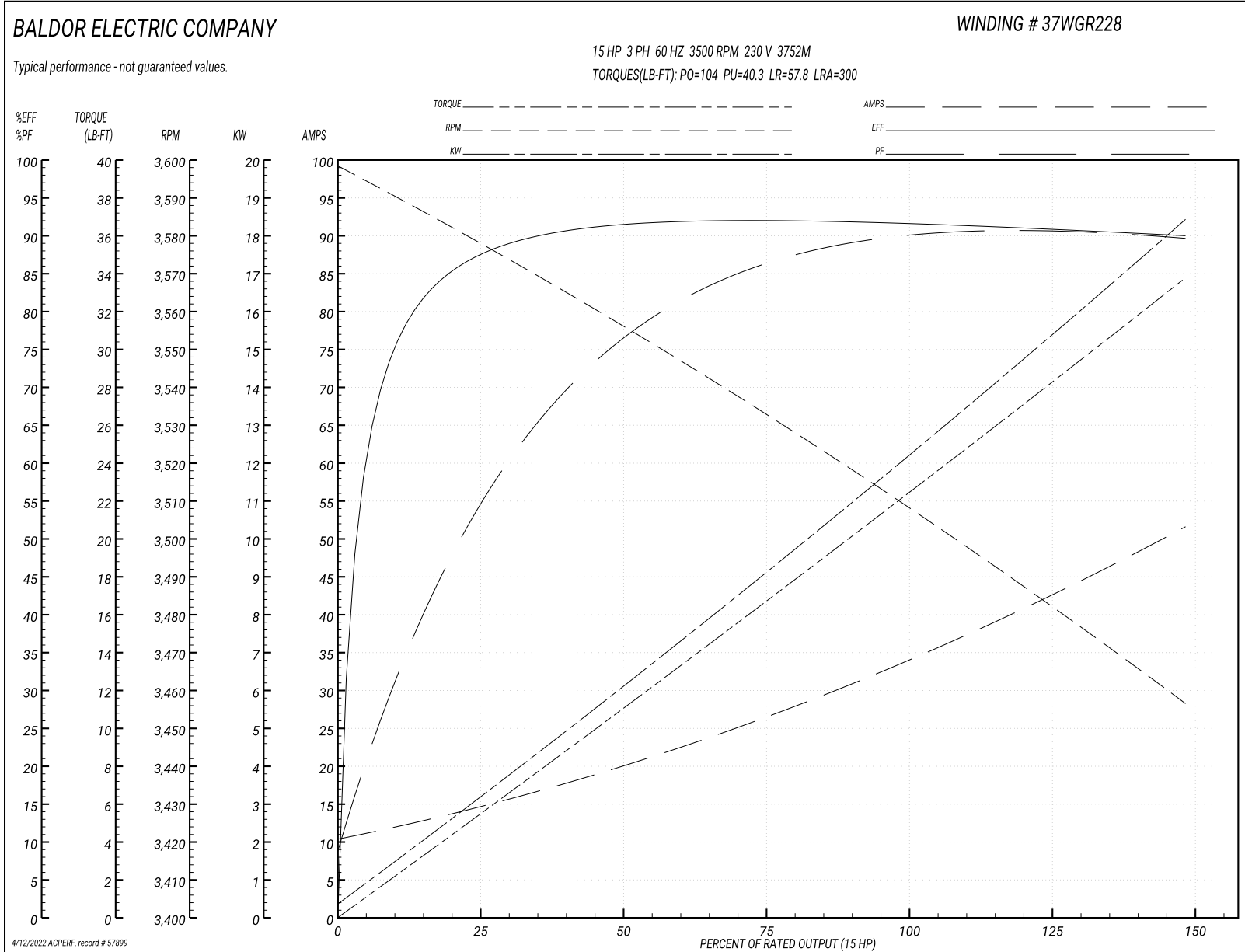

AC Induction Motor Performance Data

Record # 70097

Typical performance - not guaranteed values

Winding: 37WGR228-RXXX		Type: 3752M		Enclosure: TEFC	
Nameplate Data			380 V, 50 Hz: High Voltage Connection		
Rated Output (HP)	15	Full Load Torque	17.68 LB-FT		
Volts	230/460	Start Configuration	direct on line		
Full Load Amps	34/17	Breakdown Torque	98.71 LB-FT		
R.P.M.	3500	Pull-up Torque	42.31 LB-FT		
Hz	60 Phase	3	Locked-rotor Torque	60.68 LB-FT	
NEMA Design Code	A KVA Code	J	Starting Current	146 A	
Service Factor (S.F.)	1.15	No-load Current	5.43 A		
NEMA Nom. Eff.	91 Power Factor	89	Line-line Res. @ 25°C	0.47 Ω	
Rating - Duty	40C AMB-CONT	Temp. Rise @ Rated Load	52°C		
S.F. Amps		Temp. Rise @ S.F. Load	63°C		
		Locked-rotor Power Factor	34.6		
		Rotor inertia	0.474 LB-FT ²		

Load Characteristics 380 V, 50 Hz, 10 HP

% of Rated Load	25	50	75	100	125	150	S.F.
Power Factor	51	73	82	87	89	90	88
Efficiency	81.7	88	89.8	89.9	89.6	88.9	89.7
Speed	2982	2964	2945	2918	2905	2883	2910
Line amperes	6.27	8.45	11.29	14.27	17.46	20.98	16.2

Performance Graph at 380V, 50Hz, 10.0HP Typical performance - Not guaranteed values

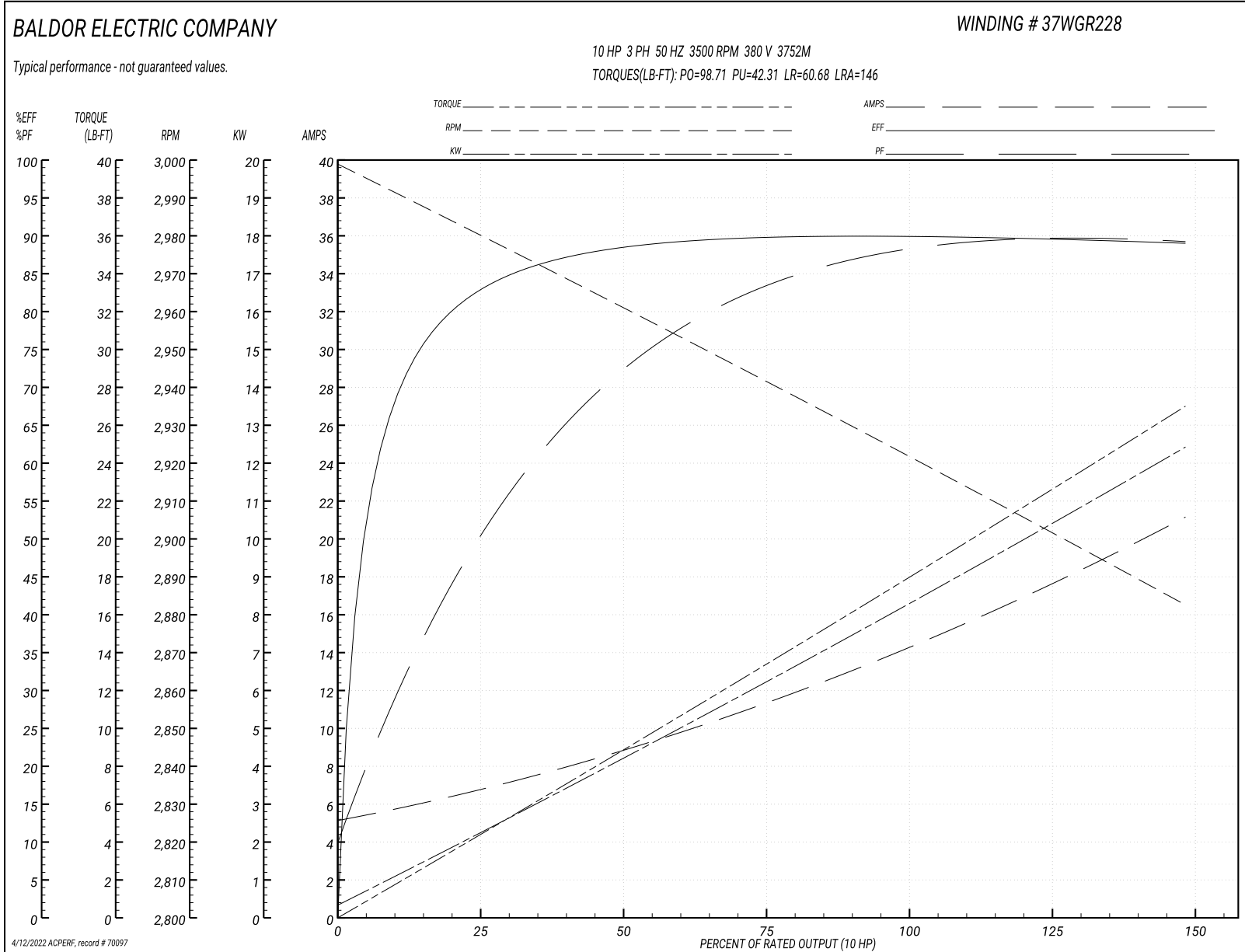

AC Induction Motor Performance Data

Record # 73419

Typical performance - not guaranteed values

Winding: 37WGR228-RXXX		Type: 3752M		Enclosure: TEFC	
Nameplate Data			480 V, 60 Hz: High Voltage Connection		
Rated Output (HP)	15	Full Load Torque	22.12 LB-FT		
Volts	230/460	Start Configuration	direct on line		
Full Load Amps	34/17	Breakdown Torque	113 LB-FT		
R.P.M.	3500	Pull-up Torque	44.76 LB-FT		
Hz	60 Phase	3	Locked-rotor Torque	64.18 LB-FT	
NEMA Design Code	A KVA Code	J	Starting Current	159 A	
Service Factor (S.F.)	1.15	No-load Current	6.32 A		
NEMA Nom. Eff.	91 Power Factor	89	Line-line Res. @ 25°C	0.47 Ω	
Rating - Duty	40C AMB-CONT	Temp. Rise @ Rated Load	67°C		
S.F. Amps		Temp. Rise @ S.F. Load	83°C		
		Locked-rotor Power Factor	31.2		
		Rotor inertia	0.474 LB-FT ²		

Load Characteristics 480 V, 60 Hz, 15 HP

% of Rated Load	25	50	75	100	125	150	S.F.
Power Factor	50	72	82	86	88	89	87
Efficiency	86.2	90.7	91.8	91.5	90.9	90.1	91.1
Speed	3580	3560	3538	3506	3491	3465	3497
Line amperes	7.28	9.85	13.18	16.77	20.58	24.75	19.1

Performance Graph at 480V, 60Hz, 15.0HP Typical performance - Not guaranteed values

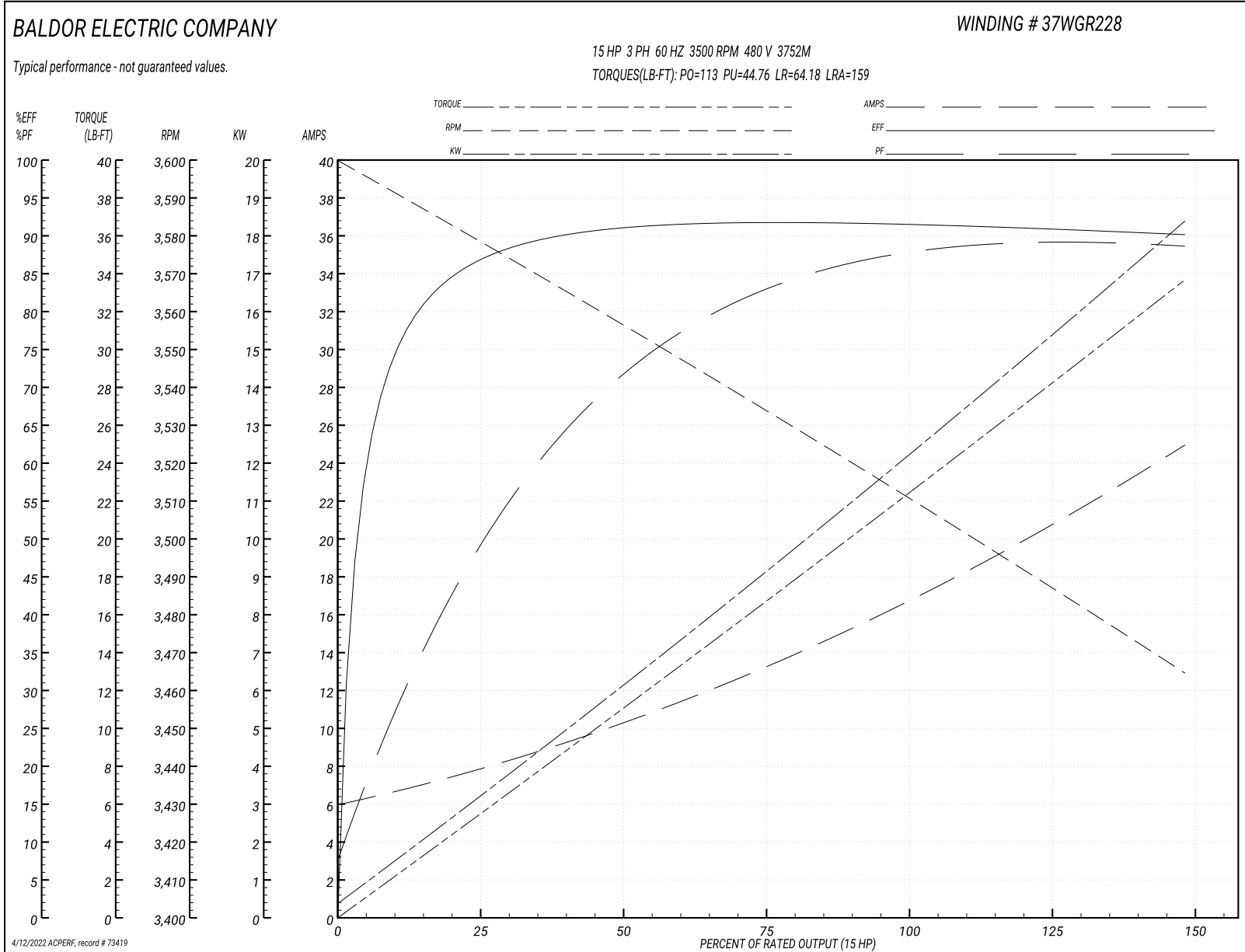

37LYG814

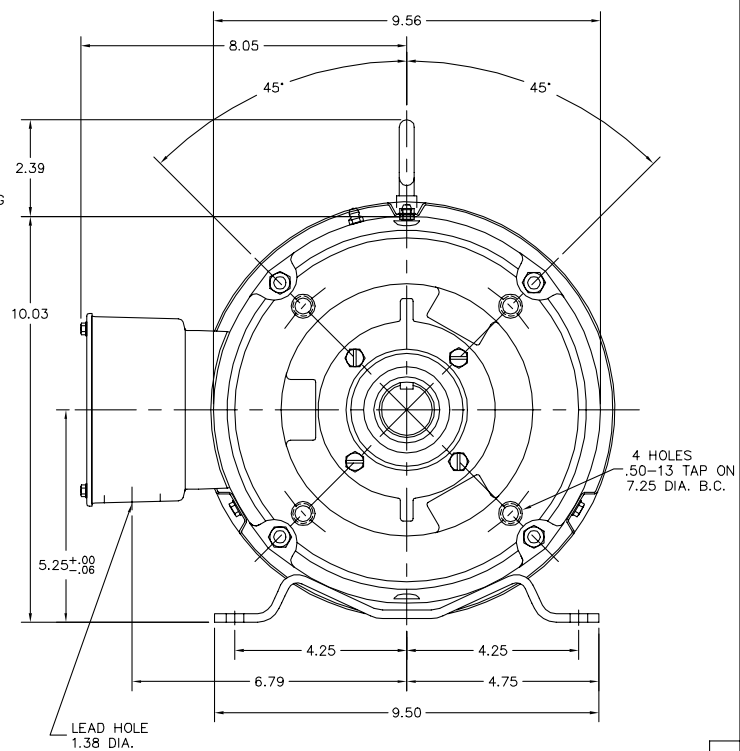
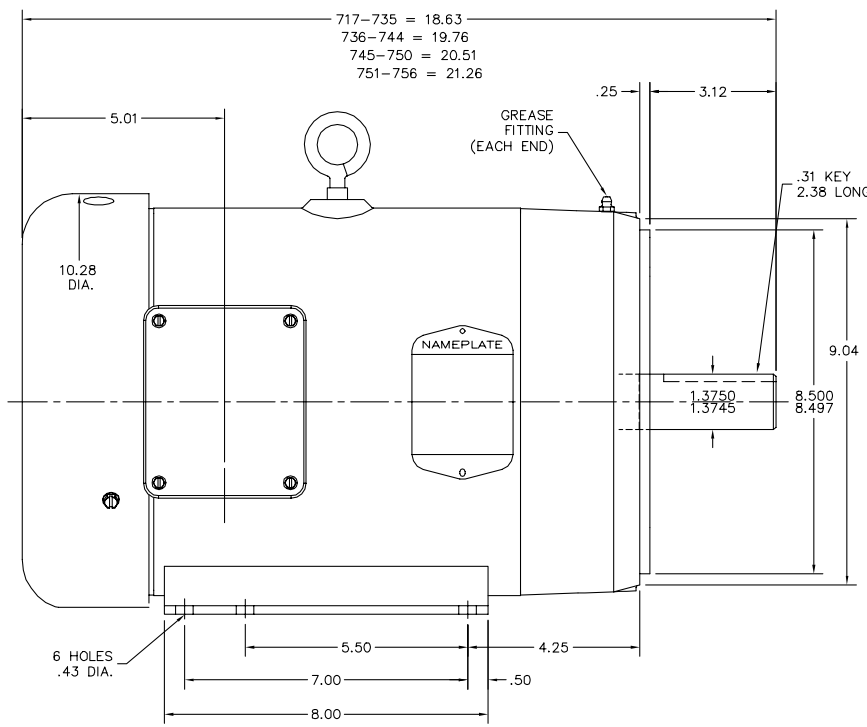

37LYG814

CUSTOMER IS RESPONSIBLE FOR DETERMINING THAT BALDOR'S PRODUCT WILL PERFORM SUITABLY IN THE INTENDED APPLICATION.

REV. DESC: UPDATE LAYOUT GRAPHICS - NO DIM CHANGES		
REV. LTR: D	VERSION: 01	TDR: 000000859468
FILE: \AAA\00051\948	REVISED: 11:08:35 06/24/2014	BY: ENBRAMO
MTL: -		

BALDOR

STD HORZ 213-5TC TEFC 37M W/EPACT SHOVE

SH 1 of 1

CD0180

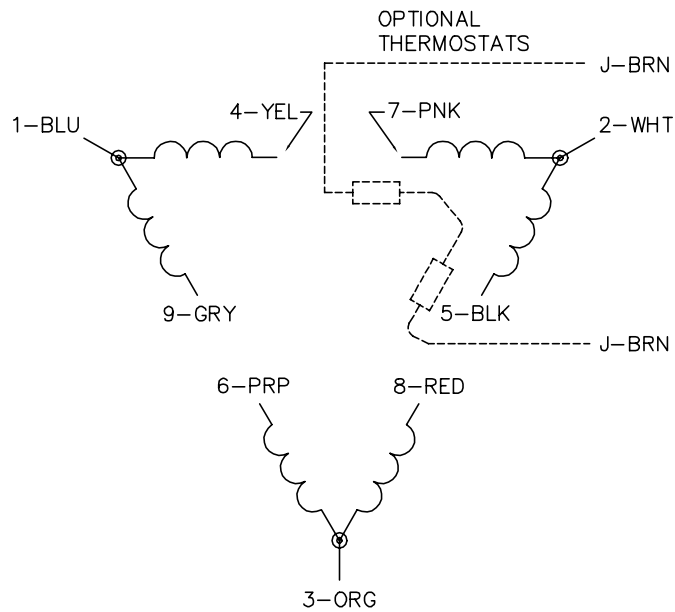

LOW VOLTAGE
(2D)

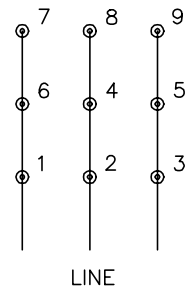

HIGH VOLTAGE
(1D)

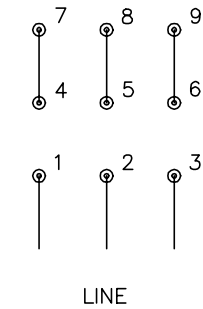

NOTES:

1. INTERCHANGE ANY TWO LINE LEADS TO REVERSE ROTATION.
2. OPTIONAL THERMOSTATS ARE PROVIDED WHEN SPECIFIED.
3. ACTUAL NUMBER OF INTERNAL PARALLEL CIRCUITS MAY BE A MULTIPLE OF THOSE SHOWN ABOVE.
4. LEAD COLORS ARE OPTIONAL. LEADS MUST ALWAYS BE NUMBERED AS SHOWN.

CD0180

REV. DESC: ADD CLASS CONN00000007		
REV. LTR: D	VERSION: 01	TDR: 000001099922
FILE: \AAA\00005\148	REVISED: 10:25:29 02/19/2019	BY: ENBRIRO
MTL: -	© □	

BALDOR - RELIANCE®

3PH, DV, 9 LEADS, DELTA CONNECTION

SH 1 of 1