

# NIDEC MOTOR CORPORATION

8050 WEST FLORISSANT AVE.  
ST. LOUIS, MO 63136



**DATE:** 4/20/2022

**P.O. NO.:** HB76  
**Order/Line NO.:** 26203 MN 100

**TO:**

**Model Number:** HB76  
**Catalog Number:** CHT5V2GLE  
VHS TEFC Configuration  
CONF,MOTOR,VHS TEFC

**REVISIONS:**  
(NONE)

**ALL DOCUMENTS HEREIN ARE CONSIDERED CERTIFIED BY NIDEC MOTOR CORPORATION.  
THANK YOU FOR YOUR ORDER AND THE OPPORTUNITY TO SERVE YOU.**

## Features:

Horsepower ..... 00005.00~00000.00 ~ KW: 3.73  
Enclosure ..... TEFC  
Poles ..... 04~00 ~ RPM: 1800~0  
Frame Size ..... 184~TP  
Phase/Frequency/Voltage.. 3~060~575  
Winding Type ..... Random Wound  
Service Factor ..... 1.15  
Insulation Class ..... Class "H" ~ Insulife 2000  
Altitude In Feet (Max) .. 3300 Ft.(1000 M) ~ +40 C  
Efficiency Class ..... Premium Efficiency  
Application ..... Vertical Centrifugal Pump  
Inverter Duty NEMA MG1 Part 31  
Customer Part Number ....  
10" Base ~ Coupling Size: 1" Bore, 1/4" Key  
Non-Reverse Ratchet ~ Steady Bushing Not Requested  
Pricebook Thrust Value (lbs).. 2500  
Customer Down Thrust (lbs) ... 2500  
Customer Shutoff Thrust (lbs).  
Up Thrust (lbs): ~  
Inverter Duty Rating Details:  
Load Type (Base Hz & Below) .. Variable Torque  
Speed Range (Base Hz & Below). 10:1  
Temperature Rise (Sine Wave): "B" Rise @ 1.0 SF (Resist)  
Design Letter ..... B  
Starting Method ..... Direct-On-Line Start  
Duty Cycle ..... Continuous Duty  
Efficiency Value ..... 89.5 % ~ NEMA Nominal  
Load Inertia: NEMA ~ Standard Inertia: 27 LB-FT<sup>2</sup>  
Number Of Starts Per Hour: NEMA  
Motor Type Code ..... TUCI  
Rotor Inertia (LB-FT<sup>2</sup>) ..... .483 LB-FT<sup>2</sup>  
Qty. of Bearings PE (Shaft) ..... 1  
Qty. of Bearings SE (OPP) ..... 1  
Bearing Number PE (Shaft) ..... 7309 BEP  
Bearing Number SE (OPP) ..... 6208-J/C3

Nidec trademarks followed by the ® symbol are registered with the U.S. Patent and Trademark Office.

# NIDEC MOTOR CORPORATION

8050 WEST FLORISSANT AVE.  
ST. LOUIS, MO 63136



**DATE:** 4/20/2022

**P.O. NO.:** HB76  
**Order/Line NO.:** 26203 MN 100

**TO:**

**Model Number:** HB76  
**Catalog Number:** CHT5V2GLE  
VHS TEFC Configuration  
CONF,MOTOR,VHS TEFC

**REVISIONS:**  
(NONE)

**ALL DOCUMENTS HEREIN ARE CONSIDERED CERTIFIED BY NIDEC MOTOR CORPORATION.  
THANK YOU FOR YOUR ORDER AND THE OPPORTUNITY TO SERVE YOU.**

**Accessories:**

Shaft Slinger - Pulley End  
Brass Drain - Lower Bracket  
Corro-Duty  
CCW Rot. FODE w/Rotation Arrow  
Ground Lug In Conduit Box  
Aegis Grd Ring/Grd Term on Frm  
115 Volt Space Heaters  
Special Balance  
Thermostats - Normally Closed  
MIN 500 RPM WITH NRR  
Standard Leadtime: NA  
Est. Weight (lbs ea): 180 ~ F.O.B.:

**USE THE DATA PROVIDED BELOW TO SELECT THE APPROPRIATE DIMENSION PRINT**

<b>Horsepower</b>	5
<b>Pole(s)</b>	04
<b>Voltage(s)</b>	575
<b>Frame Size</b>	184TP
<b>Outlet Box AF</b>	2.00
<b>Outlet Box AA</b>	1.00

Nidec trademarks followed by the ® symbol are registered with the U.S. Patent and Trademark Office.

EFFECTIVE:  
10-OCT-18

SUPERSEDES:  
06-JUN-18

# DIMENSION PRINT

TEFC

FRAME: 180, 210TP  
BASIC TYPE: TUCI

PRINT:  
09-3346

SHEET:  
1 OF 1

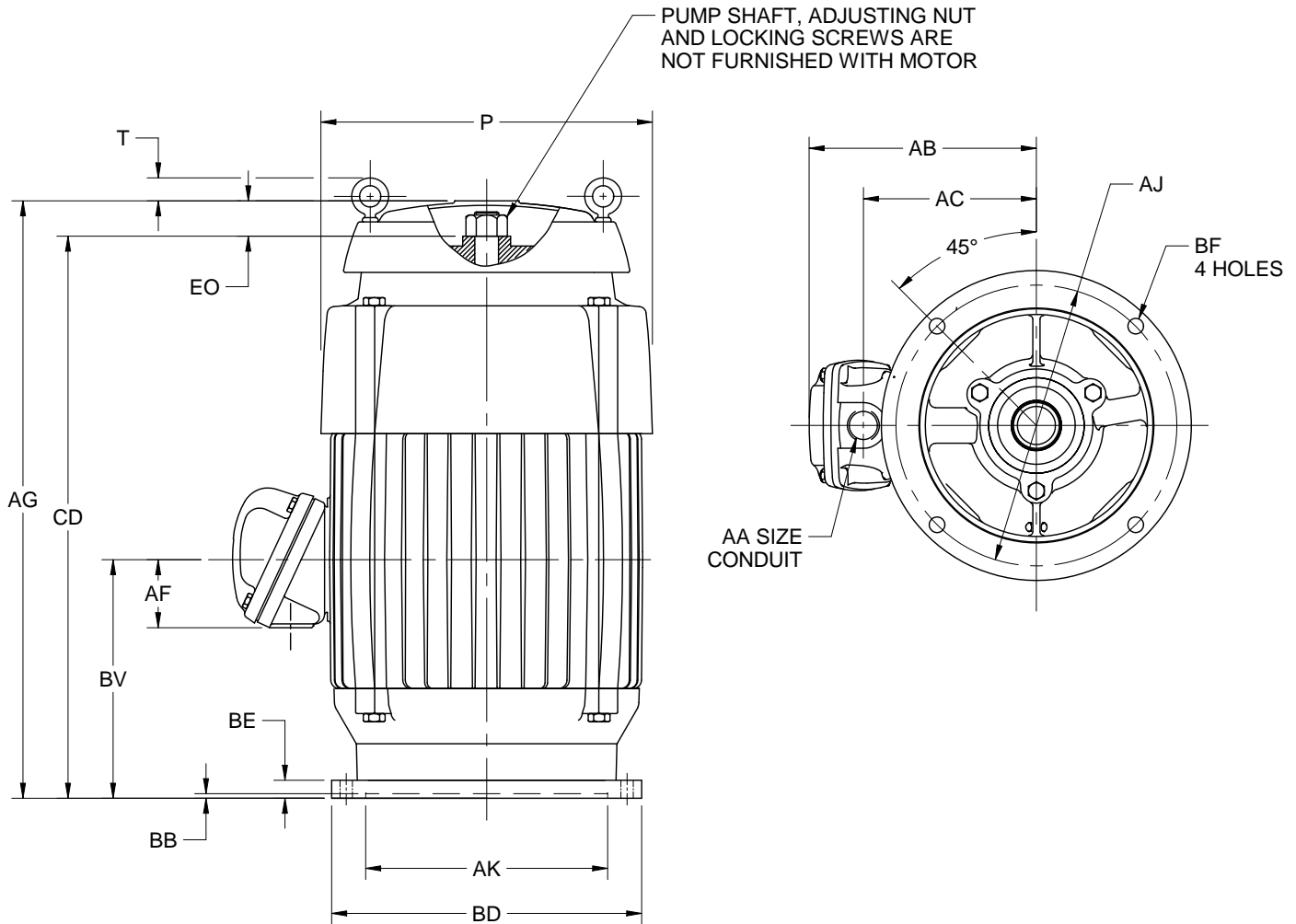

ALL DIMENSIONS ARE IN INCHES AND MILLIMETERS

UNITS	P <sup>2</sup>	T	AA	AB	AC	AF	AG	AJ	AK +.003	BB MIN	BD MAX
IN	10.81	1.63	1 NPT	9.81	7.25	2.00	21.13	9.125	8.250	.22	10.00
MM	275	41		249	184	51	537	231.7	209.55	6	254

UNITS	BE	BF	BV	CD	EO
IN	.75	.44	8.00	17.50	3.31
MM	19	11	203	445	84

- ALL ROUGH CASTING DIMENSIONS MAY VARY BY .25" DUE TO CASTING AND/OR FABRICATION VARIATIONS.
- LARGEST MOTOR WIDTH.
- CONDUIT BOX MAY BE LOCATED ON EITHER SIDE OR ON TOP OF MOTOR. CONDUIT OPENINGS MAY BE LOCATED IN STEPS OF 90° REGARDLESS OF LOCATION. STANDARD AS SHOWN WITH CONDUIT OPENING DOWN.
- TOLERANCES SHOWN ARE IN INCHES ONLY.

TOLERANCES	
FACE RUNOUT	.004 T.I.R.
PERMISSIBLE ECCENTRICITY OF MOUNTING RABBET	.004 T.I.R.

**Nidec Motor Corporation**  
St. Louis, Missouri

INFORMATION DISCLOSED ON THIS DOCUMENT IS CONSIDERED PROPRIETARY AND SHALL NOT BE REPRODUCED OR DISCLOSED WITHOUT WRITTEN CONSENT OF NIDEC MOTOR CORPORATION



ISSUED BY  
**R. LOPEZ**  
APPROVED BY  
**O. PEREZ**

# NAMEPLATE DATA

CATALOG NUMBER:	CHT5V2GLE	NAMEPLATE PART #:	422707-005	
MODEL	HB76	FR	184TP	
SHAFT END BRG	7309 BEP - QTY 1		OPP END BRG	6208-J/C3 - QTY 1
PH	3	MAX AMB	40 C	
INSUL CLASS	H	Asm. Pos.		
HP	5	RPM	1770	
VOLTS	575	HP		
FL AMPS	5.4	RPM		
SF AMPS	6.0	VOLTS		
SF	1.15	FL AMPS		
DESIGN	B	SF AMPS		
CODE	J	SF		
NEMA NOM EFFICIENCY	89.5	DESIGN		
NOM PF	77.6	CODE		
KiloWatt	3.73	NEMA NOM EFFICIENCY		
GUARANTEED EFFICIENCY	87.5	NOM PF		
MAX KVAR		GUARANTEED EFFICIENCY		
HZ	60	MAX KVAR		
		HZ		
		DUTY	CONT	

**HAZARDOUS LOCATION DATA (IF APPLICABLE):**

DIVISION		CLASS I		GROUP I	
TEMP CODE		CLASS II		GROUP II	



**VFD DATA (IF APPLICABLE):**

VOLTS	575	AMPS	5.7
TORQUE 1	14.8LB-FT	TORQUE 2	
VFD LOAD TYPE 1	VT/PWM	VFD LOAD TYPE 2	
VFD HERTZ RANGE 1	6-60	VFD HERTZ RANGE 2	
VFD SPEED RANGE 1	180-1800	VFD SPEED RANGE 2	
SERVICE FACTOR	1.00	FL SLIP	
NO. POLES		MAGNETIZING AMPS	
VECTOR MAX RPM		Encoder PPR	
Radians / Seconds		Encoder Volts	

**TEAO DATA (IF APPLICABLE):**

HP (AIR OVER)		HP (AIR OVER M/S)		RPM (AIR OVER)		RPM (AIR OVER M/S)	
FPM AIR VELOCITY		FPM AIR VELOCITY M/S		FPM AIR VELOCITY SEC			

**ADDITIONAL NAMEPLATE DATA:**

Decal / Plate	WD=499495	Customer PN	
Notes		Non Rev Ratchet	NRR
Max Temp Rise	80C RISE/RES@1.00SF	OPP/Upper Oil Cap	GREASE
Thermal (WDG)	OVER TEMP PROT 2	SHAFT/Lower Oil Cap	GREASE
Altitude		Usable At	
Regulatory Notes		Regulatory Compliance	
COS		Marine Duty	
Balance	0.08 IN/SEC	Arctic Duty	
3/4 Load Eff.	89.5	Inrush Limit	
Motor Weight (LBS)	180	Direction of Rotation	
Sound Level		Special Note 1	
Vertical Thrust (LBS)	2500	Special Note 2	
Thrust Percentage	100% HT	Special Note 3	
Bearing Life		Special Note 4	
Starting Method		Special Note 5	
Number of Starts		Special Note 6	
200/208V 60Hz Max Amps		SH Max. Temp.	
190V 50 hz Max Amps		SH Voltage	SH VOLTS=115V
380V 50 Hz Max Amps		SH Watts	SH WATTS= 36W
NEMA Inertia		Load Inertia	
Sumpheater Voltage		Sumpheater Wattage	
Special Accessory Note 1		Special Accessory Note 16	
Special Accessory Note 2		Special Accessory Note 17	
Special Accessory Note 3		Special Accessory Note 18	
Special Accessory Note 4		Special Accessory Note 19	
Special Accessory Note 5		Special Accessory Note 20	
Special Accessory Note 6		Special Accessory Note 21	
Special Accessory Note 7		Special Accessory Note 22	
Special Accessory Note 8		Special Accessory Note 23	
Special Accessory Note 9		Special Accessory Note 24	
Special Accessory Note 10		Special Accessory Note 25	
Special Accessory Note 11		Special Accessory Note 26	
Special Accessory Note 12		Special Accessory Note 27	
Special Accessory Note 13		Special Accessory Note 28	
Special Accessory Note 14		Special Accessory Note 29	
Special Accessory Note 15		Special Accessory Note 30	MIN 500 RPM WITH NRR
Heater in C/B Voltage		Heater in C/B Watts	
Zone 2 Group		Division 2 Service Factor	
Note 1		Note 2	
Note 3		Note 4	
Note 5		Note 6	
Note 7		Note 8	
Note 9		Note 10	
Note 11		Note 12	
Note 13		Note 14	
Note 15		Note 16	
Note 17		Note 18	
Note 19		Note 20	
Note 21		Note 22	

**NIDEC MOTOR CORPORATION**  
ST. LOUIS, MO

TYPICAL NAMEPLATE DATA  
ACTUAL MOTOR NAMEPLATE LAYOUT MAY VARY  
SOME FIELDS MAY BE OMITTED



## MOTOR PERFORMANCE

MODEL NO.	CATALOG NO.	PHASE	TYPE	FRAME
HB76	CHT5V2GLE	3	TUCI	184TP
ORDER NO.		26203		LINE NO.
MPI:				259573
HP:				5
POLES:				4
VOLTS:				575
HZ:				60
SERVICE FACTOR:				1.15
EFFICIENCY (%):				
S.F.				89.4
FULL				89.5
3/4				89.5
1/2				87.7
1/4				80.6
POWER FACTOR (%):				
S.F.				80.2
FULL				77.6
3/4				70.6
1/2				58.2
1/4				37
NO LOAD				6.6
LOCKED ROTOR				49.2
AMPS:				
S.F.				6
FULL				5.4
3/4				4.4
1/2				3.7
1/4				3.1
NO LOAD				3
LOCKED ROTOR				38
NEMA CODE LETTER				J
NEMA DESIGN LETTER				B
FULL LOAD RPM				1770
NEMA NOMINAL / EFFICIENCY (%)				89.5
GUARANTEED EFFICIENCY (%)				87.5
MAX KVAR				2.5
AMBIENT (°C)				40
ALTITUDE (FASL)				3300
SAFE STALL TIME-HOT (SEC)				16
SOUND PRESSURE (DBA @ 1M)				60
TORQUES:				
BREAKDOWN{% F.L.}				349
LOCKED ROTOR{% F.L.}				256
FULL LOAD{LB-FT}				14.8

NEMA Nominal and Guaranteed Efficiencies are up to 3,300 feet above sea level and 25 ° C ambient.

The Above Data Is Typical, Sinewave Power Unless Noted Otherwise

**NIDEC MOTOR CORPORATION**  
ST. LOUIS, MO





499495

### Motor Wiring Diagram

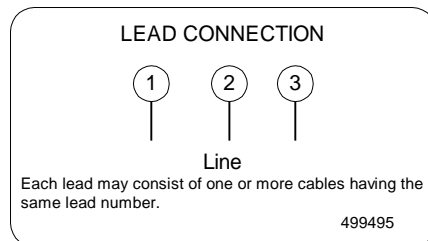
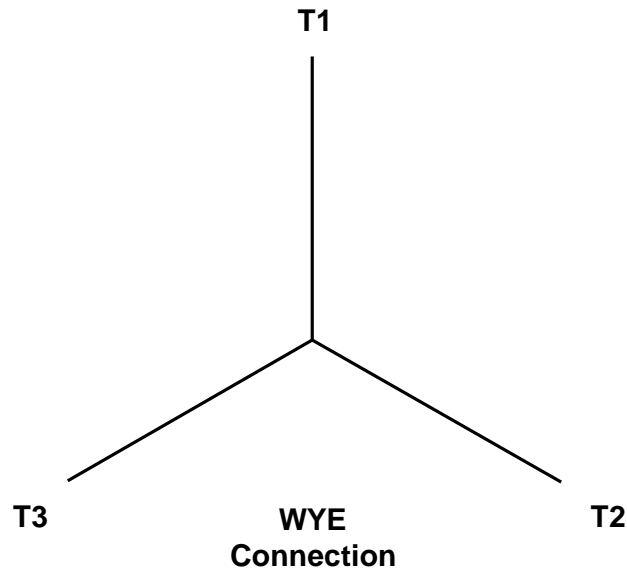

To reverse direction of rotation interchange connections L1 and L2.  
Each lead may be comprised of one or more cables.  
Each cable will be marked with the appropriate lead number.

THERMOSTATS

1. MOTOR IS EQUIPPED WITH QTY-3 (1 PER PHASE) NORMALLY CLOSED THERMOSTATS. THERMOSTATS ARE SET TO OPEN AT HIGH TEMPERATURE.
2. CONTACT RATINGS FOR THERMOSTATS: 120-600 VAC, 720 VA

N. C. THERMOSTATS

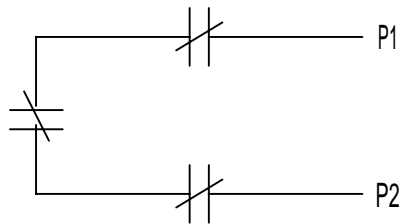

NOTE: THERMOSTATS LEADS MAY BE LOCATED IN EITHER THE MAIN OUTLET BOX OR IF SO EQUIPPED, AN AUXILIARY BOX.

ACCESSORY LISTING
QTY-3 N.C. THERMOSTATS

REVISION DESCRIPTION FOR: <b>MISC</b>	SCALE	UNITS	TITLE		<b>NIDEC MOTOR CORPORATION</b>
<b>STL0211 - UPDATED FORMAT .</b>	<b>NONE</b>	<b>IN</b>	<b>CUSTOMER CONNECTION DIAGRAM</b>		
	TOLERANCES ON DIMENSIONS (UNLESS OTHERWISE SPECIFIED)		ISSUED BY	APPROVED BY	REVISION DATE
MATERIAL:	<u>INCHES</u>	<u>mm</u>	<b>R. KING</b>	<b>C. CADE</b>	<b>24-FEB-11</b>
---	ANGLES X°= ±1°		CODE	DWG NO.	REV
				<b>0834066</b>	<b>G</b>
					SHEET NUMBER
					<b>1 OF 1</b>
					DWG SIZE
					<b>A</b>





970798

# SPACE HEATER CONNECTION DIAGRAM

SPACE HEATER LEADS MAY BE LOCATED IN EITHER THE MAIN OUTLET BOX  
OR IF SO EQUIPPED, AN AUXILIARY BOX

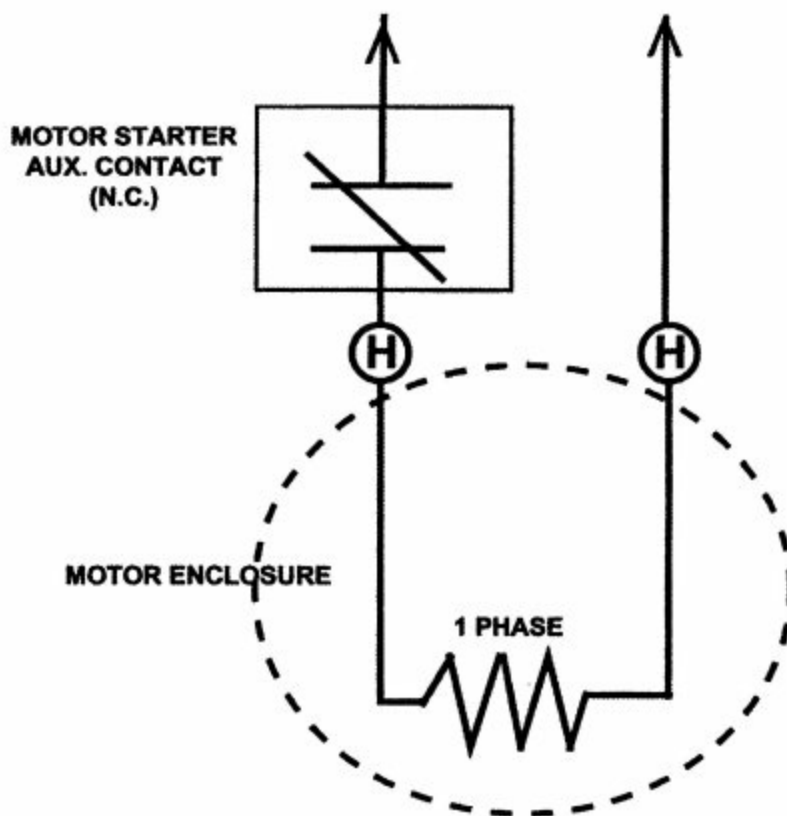

THIS EQUIPMENT IS SUPPLIED WITH ANTI-CONDENSATION HEATERS. HEATERS SHOULD BE ENERGIZED WHEN EQUIPMENT IS NOT OPERATING TO PROTECT UNIT BY PREVENTING INTERNAL CONDENSATION. CONNECT THE "H" OR HEATER LEADS TO

<b>115V</b> VOLTS	<b>36W</b> WATTS RATING
-------------------	-------------------------

**SPACE HEATER NAMEPLATE (ON MOTOR)**

# Vertical HOLLOSHAFT Coupling Dimensions

## Standard Coupling Dimensions

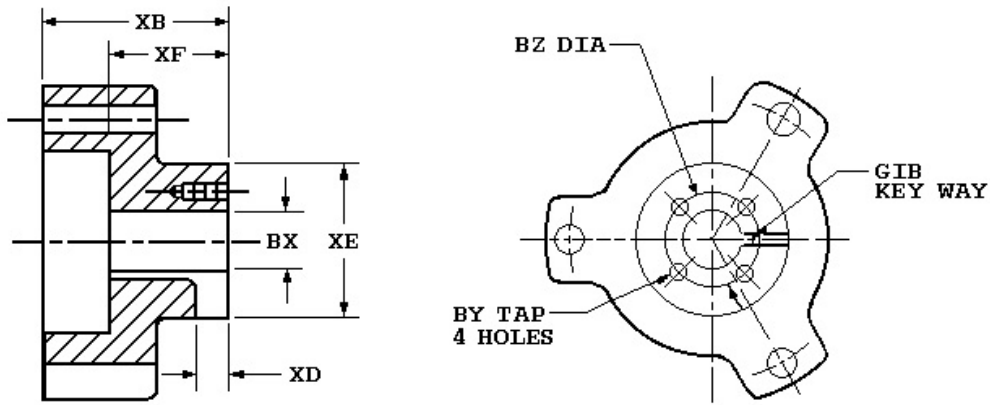

Coupling Part Number	159001
BX Nominal	1
Actual Bore	1.001
BY	10-32
BZ	1 3/8
XB	1 3/4
XD	13/32
XE	2
XF	1 1/8
SQ. KEY	1/4

### Notes:

1. All Rough casting dimensions may vary by 0.25" due to casting variations.
2. All tapped holes are Unified National Course, Right Hand thread.
3. Coupling bore dimension "BX" is machined with a tolerance of - .000", +.001" up to 1.50" bore inclusive. Larger bores: -.000", +.002".



Copyright © 2010 Nidec Motor Corporation. All rights reserved.

## TYPICAL REED CRITICAL FREQUENCY DATA

Note: Motor RCF Test Data can be provided at time of motor shipment through special test.  
Please contact your Nidec Motor Corporation representative for more information.

MODEL NO: HB76  
CATALOG NO: CHT5V2GLE

Frame: 184TP Type: TUCI

REED CRITICAL FREQUENCY:	95	HZ
CENTER OF GRAVITY:	9	IN
DEFLECTION @ CENTER OF GRAVITY:	0.0011	IN
UNIT WEIGHT:	200	LBS
BASE DIAMETER:	ALL	IN
TOLERANCE ON RCF VALUE:	20%	
DATE:	4/20/2022	



Copyright © 2010 Nidec Motor Corporation. All rights reserved.

# General Information for Integral Horsepower (IHP) Motors on Variable Frequency Drives (VFDs)

## Variable Frequency Drives (VFD)

A VFD is a type of controller used to vary the speed of an electric motor. The VFD takes a fixed AC voltage and frequency and allows it to be adjusted in order to get different speeds from the motor. Motor speed can be varied by changing the frequency of the input power waveform. The equation below shows how the frequency affects the speed of a three phase induction motor.

$$\text{Speed} = \frac{120 * \text{Fundamental Input Frequency}}{\text{Number of Motor Poles}}$$

## How does a VFD work?

A VFD takes the fixed frequency and voltage sine wave from the power grid or power station and puts it through a few steps in order to allow the VFD user to vary the frequency and in turn control the motor speed. First it rectifies the AC power into DC Power. Because of this step, a term commonly used instead of VFD is inverter. This only describes one step of what the VFD does to the power waveform. Once rectified into a DC voltage the drive sends the power through a set of transistors or switches. These switches can take the DC waveform and by opening and closing at certain speeds and durations can create an output waveform that mimics the sine wave that is required to drive a three phase electric motor. The output wave form is known as a Pulse Width Modulation (PWM) waveform because the waveform is created by multiple pulses of the switches at short intervals.

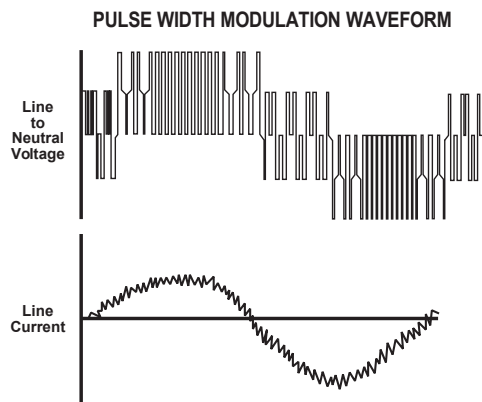

Figure 1 PWM Waveform

## What variables should be considered when deciding whether to power a motor with a VFD?

VFD compatibility with motors is complex. As a result, many variables must be considered when determining the suitability of a particular motor for use with a VFD. These variables include:

- Torque requirements (Constant or Variable)
- Speed Range
- Line / System Voltage
- Cable length between the VFD and the motor
- Drive switching (carrier) frequency
- Motor construction

- VFD dv/dt - winding end turn differential in voltage versus differential in time
- High temperatures or high humidity
- Grounding system

Wider speed ranges, higher voltages, higher switching frequencies, insufficient grounding and increased cable lengths all add to the severity of the application and, therefore, the potential for premature motor failure.

## How does a VFD affect the motor?

There are many things to consider when a motor is powered using a VFD or PWM power. When a motor is powered by a PWM waveform the motor windings very often see a large differential voltage, either from phase to phase or turn to turn. When the voltage differential becomes large enough it creates a reaction at the molecular level that converts available oxygen into O<sub>3</sub>. This phenomenon is called partial discharge or corona. This reaction creates energy in the form of light and heat. This energy has a corrosive effect on the varnish used to protect the motor windings. PWM waveforms can also magnify shaft voltages which lead to arcing across the bearing and causing premature bearing failure. Corrective action must be taken to mitigate these issues that arise when using an electric motor with a VFD.

## How do I protect the motor?

Nidec Motor Corporation (NMC) has developed specific motor designs to decrease the harmful affects that a VFD can have on a motor. NMC's INVERTER GRADE<sup>®</sup> insulation system is the first line of defense against corona and phase to phase faults that can be common when a motor is powered using a PWM waveform. The INVERTER GRADE<sup>®</sup> insulation system is standard on all of NMC's Inverter Duty products. Along with the INVERTER GRADE<sup>®</sup> insulation, thermostats are installed as a minimum protection against over heating the motor. Special consideration must also be given to bearings in motors powered by VFD's. In order to create a low resistance path to ground for built up shaft voltages a shaft grounding device can be used. On larger horsepower motors an insulated bearing system should be used in conjunction with the shaft grounding device when installed, to force the stray shaft voltages to ground. The bearing failures are more prominent on motors with thrust handling bearings. NMC has created an Inverter Duty vertical motor line that not only uses the INVERTER GRADE<sup>®</sup> insulation system, but that also comes standard with a shaft grounding device. On motors that are 100 HP and greater the thrust bearing is also insulated for additional protection.

## What does "Inverter Duty" mean?

An Inverter Duty motor should describe a motor that helps mitigate potential failure modes of a motor that is powered by a VFD. Inverter duty motor windings should be able to withstand the voltage spikes per NEMA MG1 Part 31.4.4.2 and protect against overheating when the motor is run at slow speeds. On thrust handling bearings it is apparent that the bearings require additional protection. Inverter Duty vertical motors should have a shaft grounding device to protect the motor bearings from fluting due to voltage discharge through the bearing. On larger motors (100HP and larger) the shaft should also be electrically isolated from the frame in order to aid the shaft grounding ring in discharging the shaft voltages to ground.

\*This information applies only to Integral Horsepower (IHP) motors as defined on the Agency Approval page, under UL<sup>®</sup> & CSA<sup>®</sup> listings where indicated.

## Thermal Overloads and Single Phase Motors

Motors with thermal overloads installed may not operate properly on a VFD. The current carrying thermal overload is designed for sine wave power. Operation on a VFD may cause nuisance tripping or potentially not protect the motor as would be expected on line power. Thermostats or thermistors installed in the motor and connected properly to the VFD may provide suitable thermal overload protection when operating on a VFD. (consult codes for installation requirements)

Single phase motors and other fractional horsepower ratings are not designed to be operated on a VFD. Within Nidec Motor Corporation standard products, all motors NEMA<sup>®</sup> 48 frame (5.5" diameter) and smaller are not suitable for VFD applications. Three phase 56 and 143/145 frame applications should be noted on the catalog price page; or if in doubt ask a Nidec Motor Corporation technical representative for recommendations on compatibility with a VFD.

## Slow Speed Motors

Motors with a base design of slower than six poles require special consideration regarding VFD sizing and minimizing harmonic distortion created at the motor terminals due to cable installation characteristics. Additional external PWM waveform filters and shielded motor cables designed for PWM power may be required to provide acceptable motor life. Harmonic distortion on the output waveform should be kept to a minimum level (less than 10%) mismatch impedance.

## 690V Applications

Motors that are rated for 690VAC and that will be powered by 690VAC PWM VFDs require the use of an external filter to limit peak voltage spikes and the use of an INVERTER GRADE<sup>®</sup> motor. Where available, an alternative to using an output filter is to upgrade to a 2300V insulation system.

## Low Voltage TITAN<sup>®</sup> Motors

When using 449 frame and larger motors on PWM type VFDs consider the use of an external filter and shielded motor cables designed for PWM power to minimize harmonic distortion and peak voltages at the motor terminals. Harmonic distortion on the output waveform should be kept to a minimum level (less than 10%).

## Bearing Currents Related to PWM Waveforms

Protection of the motor bearings from shaft currents caused by common mode voltages is becoming a standard feature on Inverter Duty motor products. Some installations may be prone to a voltage discharge condition through the motor bearings called Electrical Discharge Machining (EDM) or fluting. Vertical HOLLOWSHAFT and HOSTILE DUTY World Motor come with grounding devices installed as standard. EDM damage is related to characteristics of the PWM waveform, and the VFD programming, and installations factors.

### Bearing Protection on Inverter Duty Vertical Motors

All U.S. MOTORS<sup>®</sup> brand "Inverter Duty" vertical products have a shaft grounding system that allows damaging shaft currents a low resistance path to ground. **Bearings on vertical motors fed by VFD power without this bearing protection are not covered under any warranty.** All other bearing failure is covered per NMC's standard warranty. An electric motor repair shop approved to service U.S. MOTORS<sup>®</sup> brand motors must verify that the cause of the bearing failure was not due to EDM damage.

## Guideline For Insulated Anti-Friction Bearings

Bearing insulation is required to prevent circulating shaft currents which can damage bearings. Circulating shaft current can be caused by use of improper power and/or ground cables, improper grounding systems and higher switching frequencies. Finding and correcting the external condition(s) is the responsibility of the system designer or specifying engineer. To prevent circulating shaft current in motors with anti-friction bearings, Nidec Motor Corporation's standard practice is to insulate the non-drive end bearing.

Adjustable Speed Drives produce a common mode voltage condition. To interrupt common mode voltage on induction motors of all sizes, NEMA MG1-2018 Part 31 recommends insulating both bearings. In cases where both anti-friction bearings are insulated, the system designer or specifying engineer should determine whether to apply one or more of the following options to prevent or reduce shaft currents: sinewave filters, line reactors or mechanical devices, such as shaft grounding or an insulated half coupling. Motors with shaft grounding devices are not suitable for installation in hazardous locations unless housed in an enclosure suitable for the specified Division (or Zone), Class and Group(s).

## Multiple Motors on a Single VFD

Special considerations are required when multiple motors are powered from a single VFD unit. Most VFD manufacturers can provide guidelines for proper motor thermal considerations and starting/stopping of motors. Cable runs from the VFD and each motor can create conditions that will cause extra stress on the motor winding. Filters may be required at the motor to provide maximum motor life.

## Grounding and Cable Installation Guidelines

Proper output winding and grounding practices can be instrumental in minimizing motor related failures caused by PWM waveform characteristics and installation factors. VFD manufacturers typically provide detailed guidelines on the proper grounding of the motor to the VFD and output cable routing. Cabling manufacturers provide recommended cable types for PWM installations and critical information concerning output wiring impedance and capacitance to ground.

## Integrated Motor and Inverter

By integrating the motor and inverter at NMC's manufacturing facility, many of the motor compatibility problems are minimized or eliminated. During the manufacturing process, the motor is matched to the inverter characteristics which ensures the winding temperature and torque levels meet the design specification. Since the inverter output wiring to the motor is nearly eliminated, bearing currents are rarely experienced. When the unit is properly grounded, reducing the output cable lengths in conjunction with an inverter grade insulation system and low factory setting of the switching frequency of the inverter drive, results in low risk of voltage peaks produced by the PWM waveform.

## Vertical Motors on VFDs

Vertical motors operated on VFD power present unique conditions that may require consideration by the user or installation engineer:

- Locked rotor and drive tripping caused by non-reversing-ratchet operation at low motor speeds. It is not recommended to operate motors at less than 1/4 of synchronous speed. If slow speeds are required contact NMC engineering.
- Unexpected / unacceptable system vibration and or noise levels caused by the torque pulsation characteristics of the PWM waveform, a system critical frequency falling inside the variable speed range of the process or the added harmonic content of the PWM waveform exciting a system component
- Application related problems related to the controlled acceleration/deceleration and torque of the motor on VFD power and the building of system pressure/ load.
- The impact the reduction of pump speed has on the down thrust reflected to the pump motor and any minimum thrust requirements of the motor bearings
- Water hammer during shutdown damaging the non-reversing ratchet

## Humidity and Non-operational Conditions

The possible build-up of condensation inside the motor due to storage in an uncontrolled environment or non-operational periods in an installation, can lead to an increased rate of premature winding or bearing failures when combined with the stresses associated with PWM waveform characteristics. Moisture and condensation in and on the motor winding over time can provide tracking paths to ground, lower the resistance of the motor winding to ground, and lower the Corona Inception Voltage (CIV) level of the winding.

Proper storage and maintenance guidelines are important to minimize the potential of premature failures. Space heaters or trickle voltage heating methods are the common methods for drying out a winding that has low resistance readings. **Damage caused by these factors are not covered by the limited warranty provided for the motor unless appropriate heating methods are properly utilized during non-operational periods and prior to motor start-up.**

NEMA<sup>®</sup> Application Guide for AC Adjustable Speed Drive Systems: <http://www.nema.org/stds/acadjustable.cfm#download>

\* This information applies only to Integral Horsepower (IHP) motors as defined on the Agency Approval page, under UL<sup>®</sup> & CSA<sup>®</sup> listings where indicated.

# Warranty Guidelines for Integral Horsepower (IHP)\* Motors on Variable Frequency Drives

## Warranty Guidelines

The information in the following section refers to the motor and drive application guidelines and limitations for warranty.

### Hazardous Location Motors

Use of a variable frequency drive with the motors in this catalog, intended for use in hazardous locations, is only approved for Division 1, Class I, Group D hazardous location motors with a T2B temperature code, with a limitation of 2:1 constant torque or 10:1 variable torque output. **No other stock hazardous location motors are inherently suitable for operation with a variable frequency drive.** If other requirements are needed, including non-listed Division 2, please contact your Nidec Motor Corporation territory manager to conduct an engineering inquiry.

### 575 Volt Motors

575 volt motors can be applied on Inverters when output filters are used. Contact the drive manufacturer for filter selection and installation requirements.

### Applying INVERTER GRADE® Insulated Motors on Variable Frequency Drives (2, 4, 6 pole)

The products within this catalog labeled “Inverter Duty” or “Vector Duty” are considered INVERTER GRADE® insulated motors. INVERTER GRADE® motors exceed the NEMA® MG-1 Part 31 standard. Nidec Motor Corporation provides a three-year limited warranty on all NEMA® frame INVERTER GRADE® insulated motors and allows long cable runs between the motor and the VFD (limited to 400 feet without output filters). Cable distance can be further limited by hot and humid environments and VFD manufacturers cable limits. These motors may be appropriate for certain severe inverter applications or when the factors relating to the end use application are undefined (such as spares).

Nidec Motor Corporation’s U.S. Motors® brand is available in the following INVERTER GRADE® insulated motors:

- Inverter Duty NEMA® frame motors good for 20:1 Variable Torque & 5:1 Constant Torque, including Vertical Type RUSI (10:1 V.T.)
- Inverter Duty motors rated for 20:1 Constant Torque
- ACCU-Torq® and Vector Duty Motors with full torque to 0 Speed or 5000:1
- 841 Plus® NEMA® Frame Motors

### Applying Premium Efficient motors (that do not have INVERTER GRADE® insulation) on Variable Frequency Drives (2, 4, 6 pole)

Premium efficient motors without INVERTER GRADE insulation meet minimum NEMA® MG-1, Section IV, Part 31.4.4.2. These motors can be used with Variable Frequency Drives (with a reduced warranty period) under the following parameters:

- On NEMA® frame 447 and smaller motors, 20:1 speed rating on variable torque loads & 4:1 speed range on constant torque loads.
- On TITAN® 449 and larger frame motors, 10:1 speed rating on variable torque loads.

- On TITAN® frame motors, inquiry required for suitability on constant torque loads.

Cable distances are for reference only and can be further limited by hot and humid environments (refer to Table 1). Refer to specific VFD

Table 1 - Cable Distances			
Maximum Cable Distance VFD to Motor			
Switching Frequency	460 Volt	230 Volt	380 Volt
3 KHz	127 ft	400 ft	218 ft
6 KHz	90 ft	307 ft	154 ft
9 KHz	73 ft	251 ft	126 ft
12 KHz	64 ft	217 ft	109 ft
15 KHz	57 ft	194 ft	98 ft
20 KHz	49 ft	168 ft	85 ft

manufacturers cable limits. Refer to the Motor/ Inverter Compatibility page for special consideration of vertical motor bearings.

## Warranty Period Clarifications and Exceptions

### Standard Energy Efficient Exclusion

Applying Standard & Energy Efficient Motors on Variable Frequency Drives is not recommended. VFD related failures on standard and energy efficient motors will not be covered under warranty.

### Vertical Motor Windings

Premium efficient vertical motors without INVERTER GRADE® insulation that are installed using the criteria described in this document and applied in the correct applications shall have a warranty while powered by a VFD for 12 months from date of installation or 18 months from date of manufacturing whichever comes first. See limited warranty page for horizontal motor warranty periods.

### Bearing Exclusion for Thrust Handling Bearings

Bearings used in premium efficient vertical motors, and all thrust handling bearings, that are powered by VFDs without shaft grounding devices or insulated bearings (when required) will not be covered under any warranty for damages caused from being powered by a VFD. All other bearing failure is covered per NMC’s standard warranty. An electric motor repair shop approved to service U.S. MOTORS® brand motors must verify that the cause of the bearing failure was not due to Electrical Discharge Machining.

### Medium Voltage and Slow Speed Considerations

Motors that are rated above 700 VAC or that are eight pole and slower require special consideration and installation and are not covered under the warranty guidelines in this document. Motors that are rated above 700VAC have special cable length and voltage differential issues that are specific to the VFD type and manufacture. The motor construction and cost may vary dramatically depending on the VFD topology and construction. Contact your NMC representative with VFD manufacturer name and model type for application and motor construction considerations. Motors that are designed eight pole and slower also require special installation and filters per the drive manufacturer.

\* This information applies only to Integral Horsepower (IHP) motors as defined on the Agency Approval page, under UL® & CSA® listings where indicated.