



Customer information packet

CPX44246T

200HP, 1785RPM, 3PH, 60HZ, 447T, TEFC, F1

Class - CLI GP C,D; CLII GP E,F,G

Division - Division I

Specifications

Enclosure	TEFC
Frame	447T
Frame Material	Iron
Frequency	60.00 Hz
Motor Letter Type	Three Phase
Output @ Frequency	200.000 HP @ 60 HZ
Phase	3
Synchronous Speed @ Frequency	1800 RPM @ 60 HZ
Voltage @ Frequency	460.0 V @ 60 HZ
XP Class and Group	CLI GP C,D; CLII GP E,F,G
XP Division	Division I
Agency Approvals	CCSA US CSA CSA EEV UL
Ambient Temperature	40 °C
Auxillary Box	No Auxillary Box
Base Indicator	Rigid
Bearing Grease Type	Polyrex EM (-20F +300F)
Constant Torque Speed Range	6-60
Current @ Voltage	222.000 A @ 460.0 V
Design Code	B
Drip Cover	No Drip Cover
Duty Rating	CONT
Efficiency @ 100% Load	96.2 %
Enclosure Modification	Severe Duty Features
Feedback Device	NO FEEDBACK
Heater Indicator	No Heater
High Voltage Full Load Amps	222.0 a
Insulation Class	F
Inverter Code	Inverter Ready
IP Rating	IP55

Part detail

Revision	-
Type	AC
Mech. spec.	
Base	
Status	PRD/A
Elec. spec.	A44WG0690
Layout	617426-328
Eff. date	05-01-2019
CD Diagram	416820-036
Poles	04
Leads	3#1/0 (02 per group)
Proprietary	False
Created date	04-29-2019

KVA Code	G
Max Speed	3600 rpm
Motor Lead Quantity/Wire Size	6 @ 1/0 AWG
Motor Standards	NEMA
Motor Type	A44120M
Mounting Arrangement	F1
Number of Poles	4
Overall Length	48.47 IN
Power Factor	88
Product Family	General Industrial
Pulley End Bearing Type	Ball
Pulley Face Code	Standard
Service Factor	1.00
Shaft Diameter	3.375 IN
Shaft Ground Indicator	No Shaft Grounding
Shaft Rotation	Reversible
Shaft Slinger Indicator	Shaft Slinger
Speed	1785 rpm
Speed Code	Single Speed
Starting Method	Direct on line
Thermal Device - Bearing	None
Thermal Device - Winding	Normally Closed Thermostat
XP Temp Code	T3C

Nameplate

NP2496L	
MOBIL POLYREX EM	

000613006PC

CLASS I GROUP C D X **NO.****CLASS II GROUP** E F G**OPERATING TEMP CODE** T3C

000901002AAA

SUITABLE FOR 55C AMB AT 1.00 A

T SINEWAVE

NP3140L

SPEC NO.	A44-5067-0690			CAT.NO.	CPX44246T			FRAME	447T
HP	200	VOLTS	460	PHASE	3	DESIGN	B	TYPE	P
RPM	1785	AMPS	222	HZ	60	AMB	40	SF	1.00
DRIVE END BEARING	90BC03J30X		DUTY	CONT	INSUL.CLASS		F		
OPP D.E. BEARING	90BC03J30X		ENCL	TEFC	CODE	G			
SF	1.15	WK2	68.32	MAG CUR	62.0	RPM MAX	3600		
CT HZ	6-60	VT HZ	0-60	CHP HZ	60-90	NEMA-NOM-EFF	96.2		
	IP66								
SER.NO.				MOTOR WEIGHT	2676				

Parts list

Part number	Description	Quantity
SA368952	SA A44-5067-0690	1.000 ea
RA358489	RA A44-5067-0690	1.000 ea
421948051	LABEL, MYLAR	1.000 ea
NP2496L	MOTOR LUBE NAMEPLATE	1.000 ea
000692000VD	LABEL WARNING	1.000 ea
LB1073	ALUM XP CAUTION LABEL	1.000 ea
000613006PC	N/P U/L (REL QTY 500)	1.000 ea
000901002AAA	N/P BLANK (RELEASE QTY 1,500)	1.000 ea
NP3140L	INVERTER DUTY, SS, CC, CSA-C US, CSA EEV	1.000 ea
HW4505A02	BREATHER/DRAIN-EXP PROOF-.250-18 PTF AIS	2.000 ea
609158001D	SLGR - 440	1.000 ea
603284001W	SLGN - 449	1.000 ea
089448117E	G28 XP FT MT DE BRKT GRP E 0894480116WCB	1.000 ea
415072001B	CLAMP	1.000 ea
083199082RA	G28 SHORT FAN COVER W/BAFFLE ASSEMBLY	1.000 ea
034180014DA	KEY 1/4X1/4X1-3/4 L	1.000 ea
078548001R	FAN KB 234/150 (84) 400	1.000 ea
004824015A	GREASE POLYREX EM	1.160 lb
032130024HB	HSHS 1-8X3" PLATED	4.000 ea
032018008CK	HHCS 3/8-16X1L PLATED	4.000 ea
032018028DK	HHCS 1/2-13X3-1/2 PLTD.	3.000 ea
415096002A	CPLG 1/8 HEX TYPE	1.000 ea
034630002AB	CPLG 1/4" PLATED	1.000 ea
415044053AX	SLINGER,DE 6318 G440	1.000 ea
410700004A	WSHR	1.000 ea
034017014AB	LCKW 3/8 STD. PLATED	4.000 ea
034017016AB	LCKW 1/2" PLATED	1.000 ea
034530064BB	P/NIP 1/4X8 PLATED	1.000 ea
034530064AB	P/NIP 1/8 X 8" L Pipe Nipple	1.000 ea
032620016KB	HSHSS; 1/4X1/2	2.000 ea
034690002AB	PPLG 1/4" PLTD.	1.000 ea

032620016LA	SOCKET SET SCREW-449	3.000 ea
415096002A	CPLG 1/8 HEX TYPE	1.000 ea
034690002AB	PPLG 1/4" PLTD.	1.000 ea
702623018B	BRKT MOUNTED G28 XP T-BARRIER - 6318 BRG	1.000 ea
032018006BK	HHCS 5/16-18X3/4 PLATED	3.000 ea
034017013AB	LCKW 5/16 STD. PLATED	3.000 ea
089448117E	G28 XP FT MT DE BRKT GRP E 0894480116WCB	1.000 ea
032018030DK	HHCS 1/2-13X3-3/4 PLTD.	3.000 ea
415044053AX	SLINGER,DE 6318 G440	1.000 ea
034017016AB	LCKW 1/2" PLATED	3.000 ea
032620016KB	HSRSS; 1/4X1/2	2.000 ea
034530064BB	P/NIP 1/4X8 PLATED	1.000 ea
034530064AB	P/NIP 1/8 X 8" L Pipe Nipple	1.000 ea
034630002AB	CPLG 1/4" PLATED	1.000 ea
032130024HB	HSHCS 1-8X3" PLATED	4.000 ea
418151014G	RETAIN RING	1.000 ea
032018006BK	HHCS 5/16-18X3/4 PLATED	3.000 ea
034017013AB	LCKW 5/16 STD. PLATED	3.000 ea
702623022A	G28 AIR DEFLECTOR DRIVE END -- PLASTIC	1.000 ea
18CB1005A09	CONDUIT BOX 444-9T XP W/(1)4"NPT	1.000 ea
18CB1505A01	STD CONDUIT BOX LID 444-449T 318 EXPL PR	1.000 ea
418150003A	GREASE FITTING CAP	1.000 ea
048977006C	GRFTG - XP	1.000 ea
034017020AB	LWSHR 3/4" PLATED (419136) 034017020AF	10.000 ea
034017018AB	5/8 MED LOCK WASHER ZP (034017018AF)	4.000 ea
035000001A	ALFTG 1/8" 1610-BL	1.000 ea
032130020FB	HSHCS 3/4-10X2-1/2L PLTD	10.000 ea
415000115H	T/LUG #2AWG-4/0AWG	1.000 ea
406099000A	PLUG - FAN COVER 320-440	1.000 ea
032018008DK	HHCS 1/2-13X1 PLATED	1.000 ea
034017016AB	LCKW 1/2" PLATED	1.000 ea
032130020EB	HSHCS 5/8-11X2-1/2PLTD.	4.000 ea
048977006C	GRFTG - XP	1.000 ea
035000001A	ALFTG 1/8" 1610-BL	1.000 ea

418150003A	GREASE FITTING CAP	1.000 ea
MG1025G05	WILKOFAST, 789.227, MED. GRAY CHAR. MET.	0.500 ga
033775004EA	DRSCR #6-1/4 304 S.S.	2.000 ea
034180054KA	7/8 SQ X 6.75 KEY	1.000 ea
604797032	447/449 WIDE SHIPPING SKID 70" X 55"	1.000 ea
032510026D	CARRIAGE BOLT - 440	2.000 ea
034001016AB	WSHR .562ID 1.375OD .109	2.000 ea
034001014AB	FLAT WASHER 3/8"PLATED	2.000 ea
033300014AC	HEX NUT, SHIPPING - 400	2.000 ea
604799003C	PLASTIC BAG 42X32X46	1.000 ea

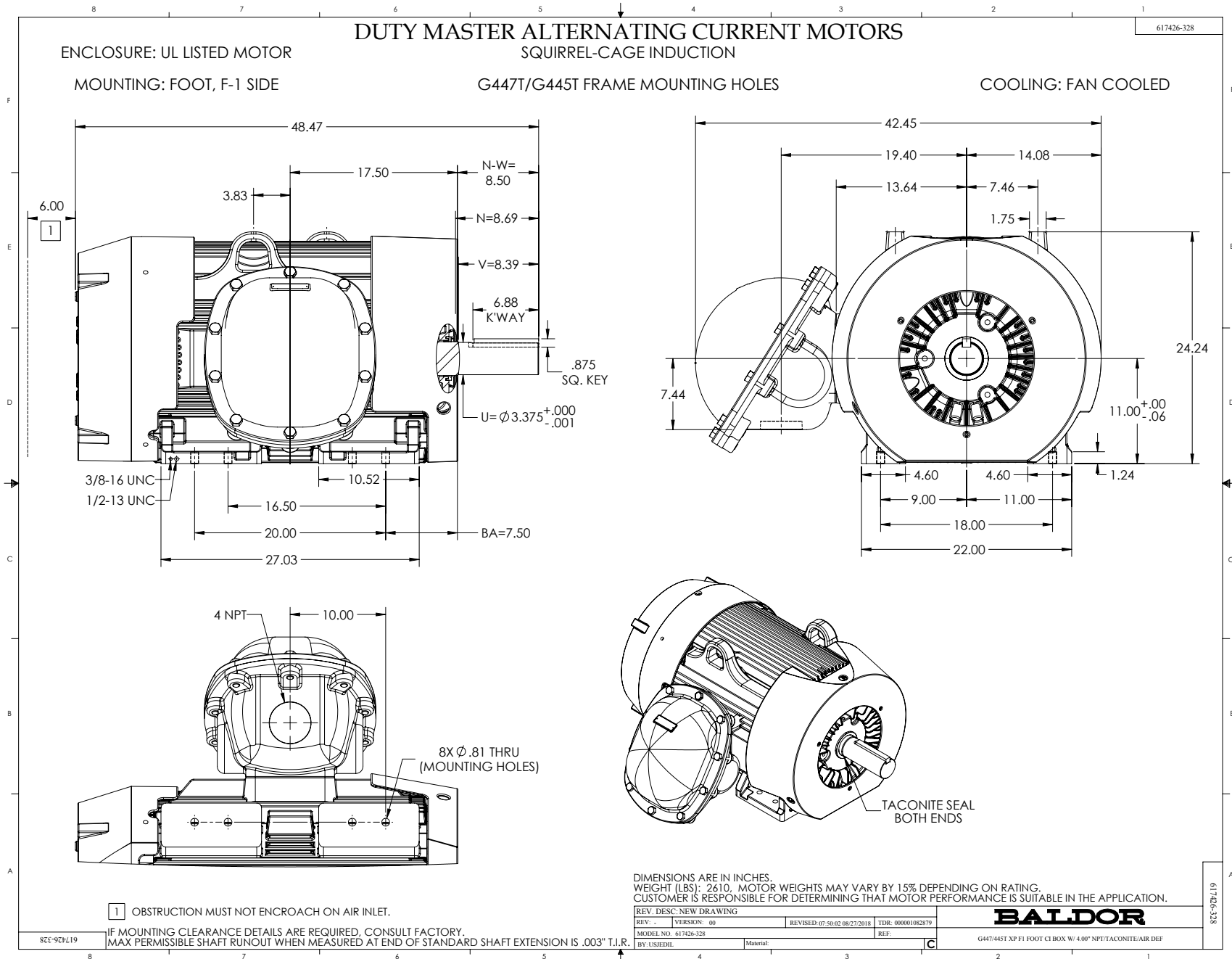

CONNECTION DIAGRAM ACCESSORIES

MOTOR WINDING THERMOSTATS	
CONTACTS _____ @ _____ °C	
FIGURE NUMBER _____	
CONTACT RATING	
VOLTS	CONTINUOUS AMPERES
110-120	3.0
220-240	1.5
440-480	0.75
550-600	0.60
	INRUSH AMPERES
	30
	15
	7.5
	6.0

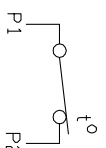
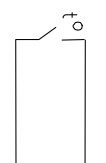
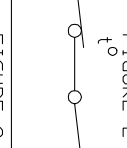
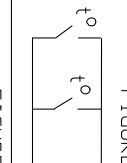
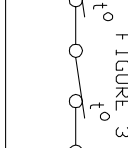
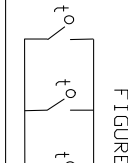
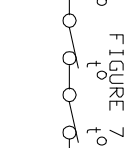
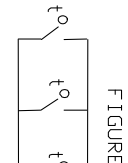
NORMALLY CLOSED	THERMOSTATS	NORMALLY OPEN
 <p>FIGURE 1</p>		 <p>FIGURE 4</p>
 <p>FIGURE 2</p>		 <p>FIGURE 5</p>
 <p>FIGURE 3</p>		 <p>FIGURE 6</p>
 <p>FIGURE 7</p>		 <p>FIGURE 8</p>

CUSTOMER _____ CUSTOMER ORDER NO. _____ S.O. NO. _____

418174-006

418174-006

REV. DESC: LOADED TO BUS		
REV. LTR: A	VERSION: 01	TDR: 000000570390
FILE: \RAG\00013\849	REVISED: 10:16:21 12/07/2010	BY: RAGDRF
MTL: -		

BALDOR
A-C MOTOR CONNECTION ACCESSORIES
SH 1 of 1

416820-036

A-C MOTOR
CONNECTION DIAGRAM
STANDARD 3 LEAD CONNECTED

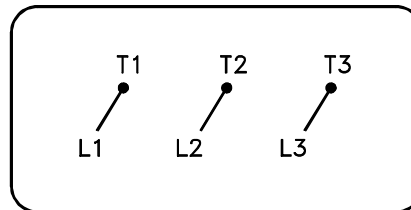

(N.P. 1575-BA)

REV. DESC: LOADED TO BUS, C/R 335225		
REV. LTR: -	VERSION: 00	TDR: 000000538207
FILE: \MGA\00000\682	REVISED: 11: 54: 06 04/30/2010	
MTL: -	BY: RAGRA	

BALDOR

CONN DIAG - STANDARD 3 LEAD
SH 1 of 1

416820-036