

TYPE	OUTPUT		POLE	TIME RATING CDNT.	VOLTAGE V	Hz	SYN SPEED R.P.M
	HP.	KW.					
ASHH	300	224	2		460	60	3600

DRIP PROOF TYPE, SQUIRREL-CAGE ROTOR

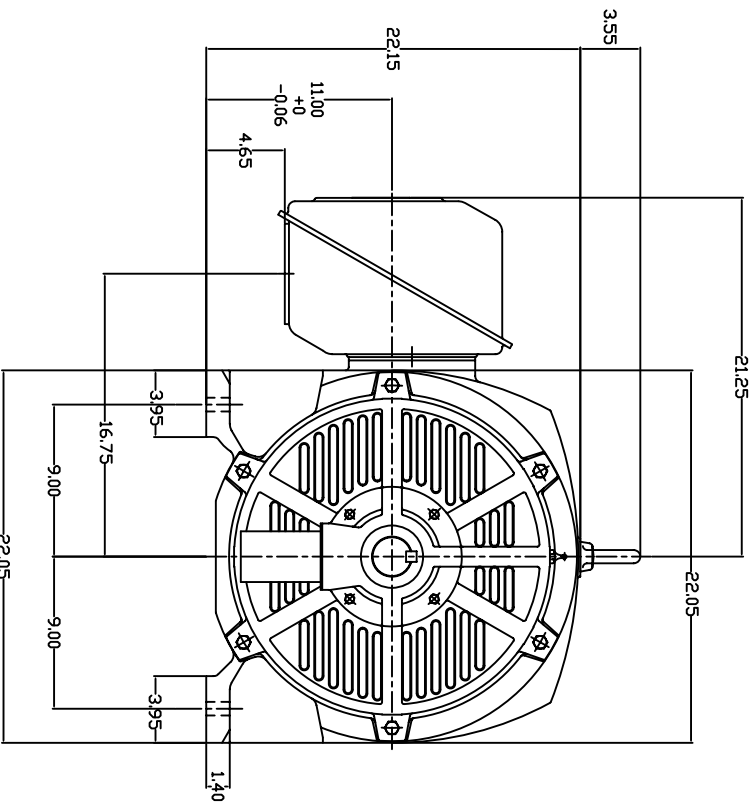
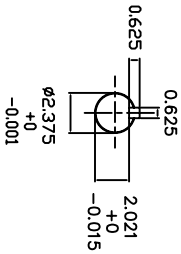
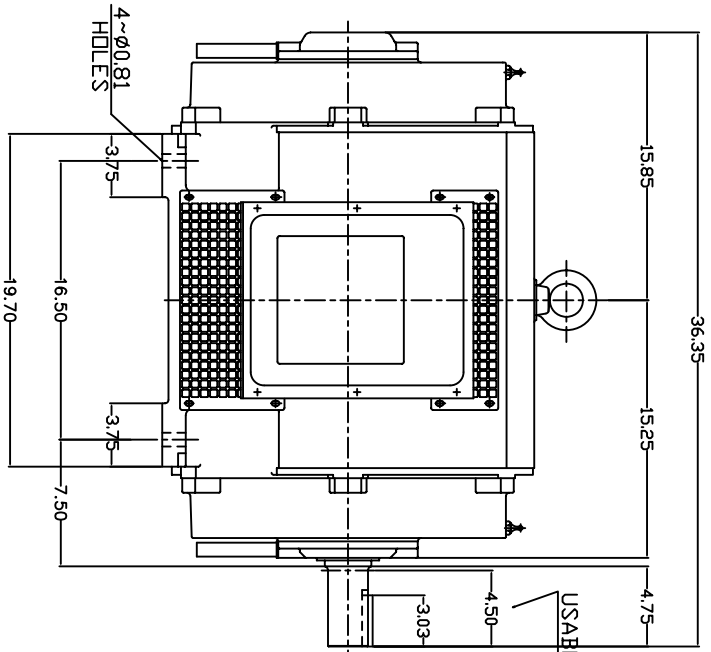

NOTE:

1. DIMENSIONS IN INCH.
2. FRAME NO. 445TS
3. F CLASS INSULATION, S.F. 115
4. FOR DIRECT FLEXIBLE COUPLING
5. BEARING SIZE: DRIVE END: 6314C3
NON-DRIVE END: 6314C3
6. MOTOR APPROX. WEIGHT: 1320 LBS

TB-56SC

DWN.	W.L.LIN	MAR. 26. 2003
CHKD.	W.L.LIN	MAR. 26. 2003
APPD.	C.WANG	MAR. 26. 2003

DATE	February 24, 2007	OUTLINE DIMENSIONS
CATALOG NO.	DHP3002	
3-PHASE INDUCTION MOTOR		DWG NO.
TEC Westinghouse		3A040T260-1
REV: 00		

TECO Westinghouse

ISSUED 05/07/07	PERFORMANCE DATA 3-PHASE INDUCTION MOTOR	ENCLOSURE ODP
TYPE ASHH		CATALOG# DHP3002

NAMEPLATE INFORMATION

OUTPUT		POLE	FRAME SIZE	VOLTAGE	HZ	RATED AMBIENT	INS. CLASS	NEMA DESIGN	TIME RATING	SERVICE FACTOR
HP	KW									
300	224	2	445TS	460	60	40°C	F	B	CONT.	1.15

TYPICAL PERFORMANCE

FULL LOAD RPM	EFFICIENCY				POWER FACTOR			MAXIMUM POWER FACTOR CORRECTION
	FULL LOAD		3/4 LOAD	1/2 LOAD	F. L.	3/4 LOAD	1/2 LOAD	
	MIN. %	NOM. %	%	%	%	%	%	
3553	94.5	95.4	94.5	93.4	89	87.3	84.3	65 KVAR

CURRENTS			NEMA KVA CODE LETTER
NO LOAD	FULL LOAD	LOCKED ROTOR	
81.7	331	2200	G

TORQUE				INERTIA			ACCEL TIME	
FULL LOAD lb-ft	LOCKED ROTOR %FLT	PULL UP %FLT	BREAK DOWN %FLT	ROTOR WR ² lb-ft ²	NEMA LOAD WK ² lb-ft ²	MAX ALLOWABLE WK ² lb-ft ²	NEMA LOAD WK ² Sec	MAX ALLOWABLE WK ² Sec
443	105	97	205	20	246	246	4.49	4.49

SAFE STALL TIME IN SECONDS		ALLOWABLE STARTS PER HOUR		SOUND PRESSURE LEVEL @ 3 FT dB(A)
COLD	HOT	COLD	HOT	
19	14	2	1	86

APPROVED:	M. PRATER	DRAWING NO.	3A057DHP3002	REVISION 0
-----------	------------------	-------------	---------------------	-------------------

DATE:
February 16, 2007

CONNECTION DIAGRAM

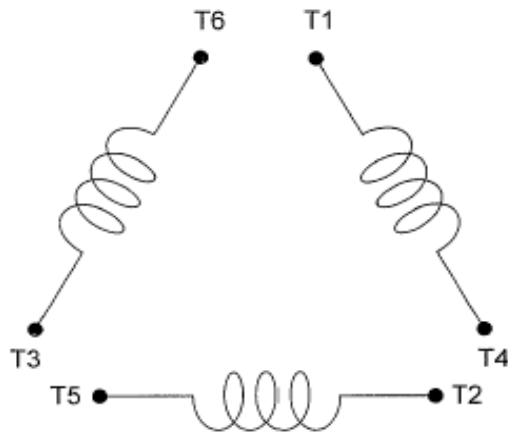

SCHEMATIC - Δ / Y CONNECTION

ACROSS THE LINE CONNECTION

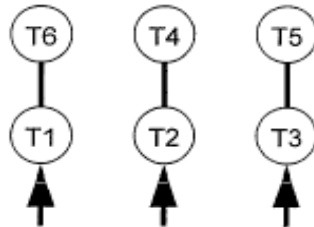

460 VOLT CONNECTION

WYE START-DELTA RUN CONNECTION

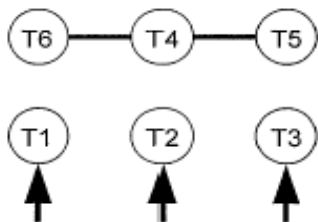

**LINE
460 VOLT START**

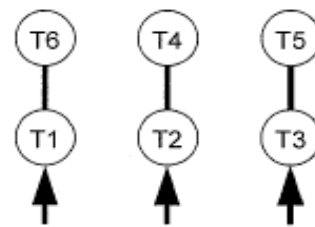

**LINE
460 VOLT RUN**