

DATE
October 28, 2016
CATALOG NO.
DJPP0102

OUTLINE DIMENSIONS
3-PHASE INDUCTION MOTOR

MOTOR TYPE:
ASGHJP
FRAME NO. 213JP

Pole	HP	kW	Hz	VOLT	Syn. Speed r/min(rpm)
2	10	7.5	60	230/460	3600

Ins	Rating	Dimension in	Approx Weight	Bearings
F	CONT.	inches	142 lbs.	DE: 6209ZZC3 NDE: 6206ZZC3

Open Protected Drip-Proof Squirrel Cage Rotor.

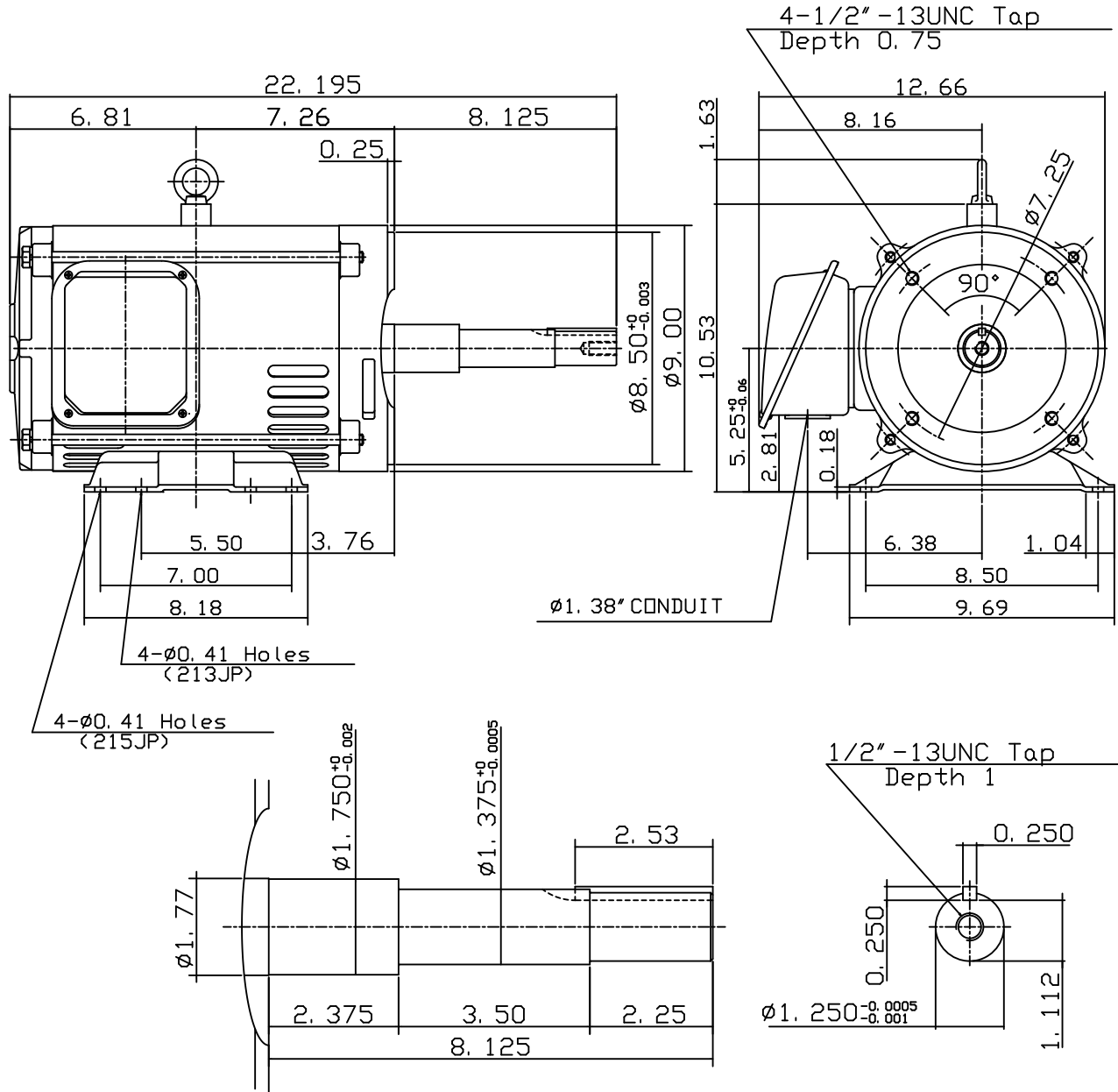

DWN. J. T. HWANG 04-11-03
CHKD. J. S. JEAN 04-11-03
APPD. Y. B. HUANG 04-11-03



DWG NO.
31049U526520

TECO Westinghouse

ISSUED 10/28/2016	PERFORMANCE DATA	ENCLOSURE ODP
TYPE ASGHJP	3-PHASE INDUCTION MOTOR	CATALOG# DJPP0102

NAMEPLATE INFORMATION

OUTPUT		POLE	FRAME SIZE	VOLTS	HZ	RATED AMBIENT	INS. CLASS	NEMA DESIGN	TIME RATING	SERVICE FACTOR
HP	KW									
10	7.46	2	213T	230/460	60	40°C	F	B	CONT.	1.15

TYPICAL PERFORMANCE

FULL LOAD RPM	EFFICIENCY				POWER FACTOR			MAXIMUM POWER FACTOR CORRECTION
	FULL LOAD		3/4 LOAD %	1/2 LOAD %	FULL LOAD %	3/4 LOAD %	1/2 LOAD %	
	MIN%	NOM%						
3505	88.5	90.2	91.0	90.5	85.5	82.0	74.0	2.74 KVAR

CURRENTS

NO LOAD				FULL LOAD				LOCKED ROTOR				NEMA KVA CODE LETTER
AT	AT	AT	AT	AT	AT	AT	AT	AT	AT	AT	AT	
200 VOLT	208 VOLT	230 VOLT	460 VOLT	200 VOLT	208 VOLT	230 VOLT	460 VOLT	200 VOLT	208 VOLT	230 VOLT	460 VOLT	
6.1	6.6	8.1	4.1	27.9	26.9	24.3	12.2	140.9	146.5	162.0	81.0	H

TORQUE

INERTIA

ACCEL TIME

FULL LOAD lb-ft	LOCKED ROTOR %FLT	PULL UP %FLT	BREAK DOWN %FLT	ROTOR WR ² lb-ft ²	NEMA LOAD WK ² lb-ft ²	MAX ALLOWABLE WK ² lb-ft ²	NEMA LOAD WK ² Sec.	MAX ALLOWABLE WK ² Sec.
14.98	200	170	250	0.408	11	33	4.16	12.18

SAFE STALL TIME IN SECONDS		ALLOWABLE STARTS PER HOUR		SOUND PRESSURE LEVEL @ 3 FT dB(A)
COLD	HOT	COLD	HOT	
17	12	2	1	60

APPROVED:	M. PRATER	DRAWING NO.	31057DJPP0102	REV. 0
-----------	------------------	-------------	----------------------	---------------

DATE:
June 28, 2005

CONNECTION DIAGRAM

CATALOG NO.:
DJPP0102



SCHEMATIC - 2Δ / Δ CONNECTION

ACROSS THE LINE CONNECTION

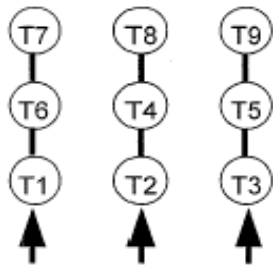

**LINE
230 VOLT CONNECTION**



**LINE
460 VOLT CONNECTION**