

DATE
MAY 28, 2009
CATALOG # DTP0104G

OUTLINE DIMENSIONS
3-PHASE INDUCTION MOTOR

MOTOR TYPE:
ASGH-SGR
FRAME NO. 215T

Pole	HP	kW	Hz	VOLT	Syn.Speed r/min(rpm)
4	10	7.5	60	230/460	1800
Ins	Rating	Dimension in	Approx Weight	Bearings	
F	CONT.	inches	143 lbs.	DE: 6208ZC3 NDE: 6206ZC3	

Open Protected Drip-Proof Squirrel Cage Rotor.

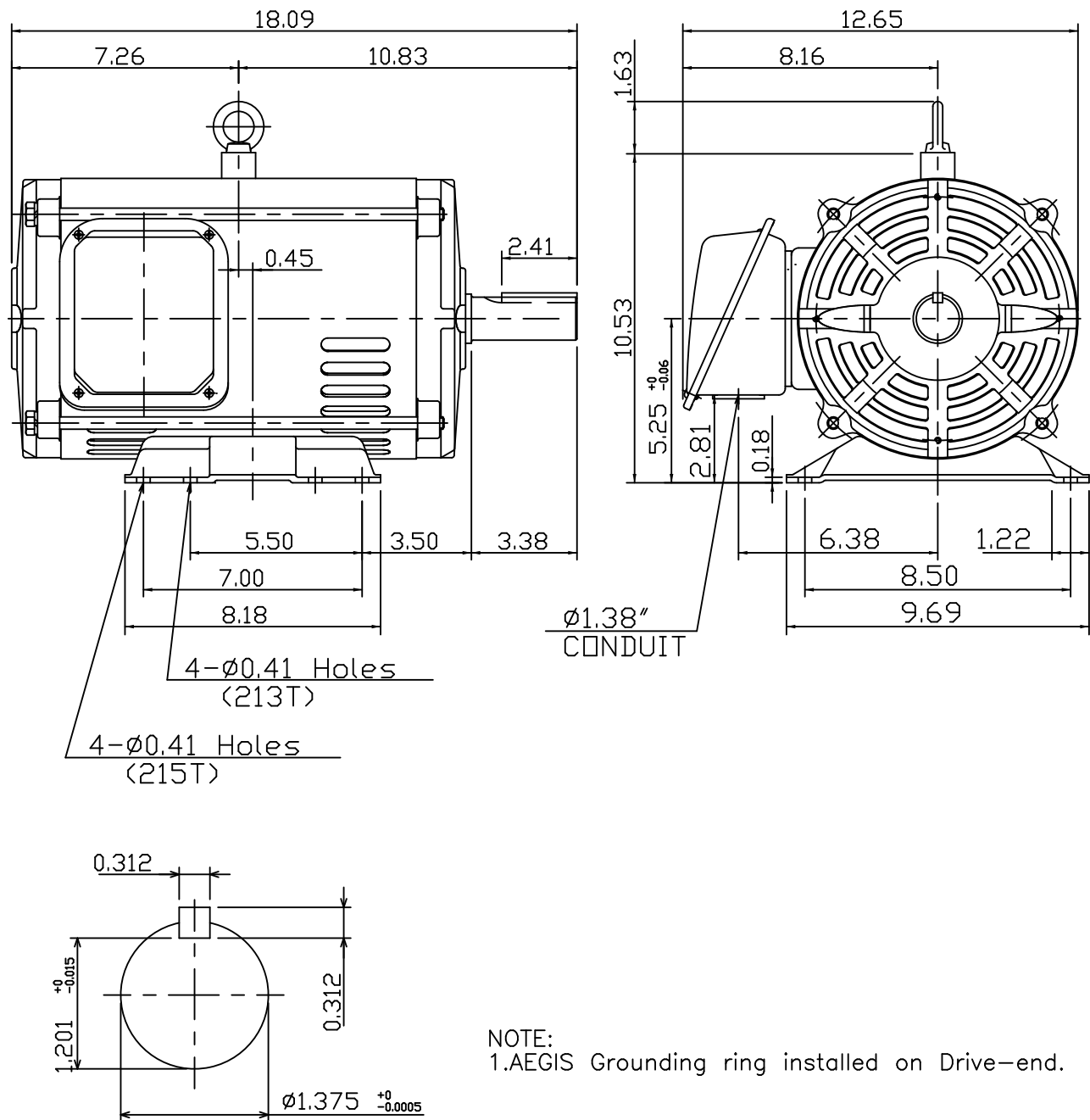

NOTE:
1.AEGIS Grounding ring installed on Drive-end.



DWN.	J.H.LIANG	04-28-08
CHKD.	H.C.YAN	05-05-08
APPD.	M.C.TSAI	05-05-08



DWG NO.
31049R172010

TECO Westinghouse

ISSUED 8/18/2015	PERFORMANCE DATA 3-PHASE INDUCTION MOTOR	ENCLOSURE ODP
TYPE ASGH-SGR		CATALOG# DTP0104G

NAMEPLATE INFORMATION

OUTPUT		POLE	FRAME SIZE	VOLTS	HZ	RATED AMBIENT	INS. CLASS	NEMA DESIGN	TIME RATING	SERVICE FACTOR
HP	KW									
10	7.46	4	215T	230/460	60	40°C	F	B	CONT.	1.15

TYPICAL PERFORMANCE

FULL LOAD RPM	EFFICIENCY				POWER FACTOR			MAXIMUM POWER FACTOR CORRECTION
	FULL LOAD		3/4 LOAD %	1/2 LOAD %	FULL LOAD %	3/4 LOAD %	1/2 LOAD %	
	MIN%	NOM%						
1755	90.2	91.7	92.0	92.0	84.0	79.0	68.5	3.32 KVAR

CURRENTS

NO LOAD				FULL LOAD				LOCKED ROTOR				NEMA KVA CODE LETTER
AT	AT	AT	AT	AT	AT	AT	AT	AT	AT	AT	AT	
200 VOLT	208 VOLT	230 VOLT	460 VOLT	200 VOLT	208 VOLT	230 VOLT	460 VOLT	200 VOLT	208 VOLT	230 VOLT	460 VOLT	
7.4	8.0	9.8	4.9	27.9	26.9	24.3	12.2	140.9	146.5	162.0	81.0	H

TORQUE

INERTIA

ACCEL TIME

FULL LOAD lb-ft	LOCKED ROTOR %FLT	PULL UP %FLT	BREAK DOWN %FLT	ROTOR WR ² lb-ft ²	NEMA LOAD WK ² lb-ft ²	MAX ALLOWABLE WK ² lb-ft ²	NEMA LOAD WK ² Sec.	MAX ALLOWABLE WK ² Sec.
29.92	235	175	280	0.916	51	153	4.21	12.47

SAFE STALL TIME IN SECONDS		ALLOWABLE STARTS PER HOUR		SOUND PRESSURE LEVEL @ 3 FT dB(A)
COLD	HOT	COLD	HOT	
17	12	2	1	65

APPROVED:	M. PRATER	DRAWING NO.	31057DTP0104G	REV. 0
------------------	------------------	--------------------	----------------------	---------------

DATE:
June 14, 2012

CONNECTION DIAGRAM

DTP0104G

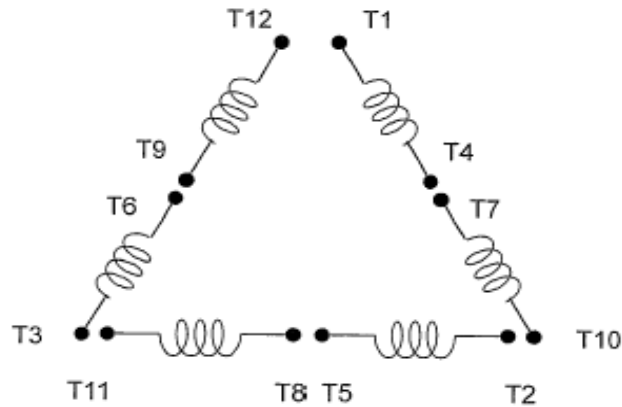

SCHEMATIC - Δ / Y CONNECTION

ACROSS THE LINE CONNECTION

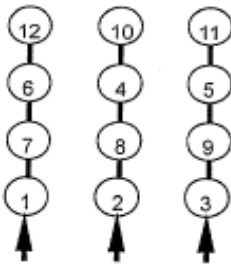

LINE
230 VOLT CONNECTION

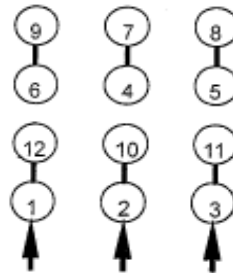

LINE
460 VOLT CONNECTION

WYE START-DELTA RUN CONNECTION

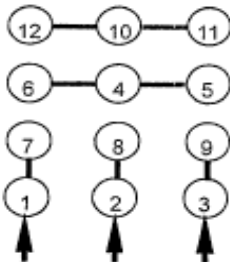

LINE
230 VOLT START

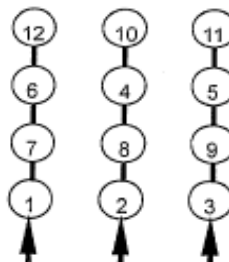

LINE
230 VOLT RUN

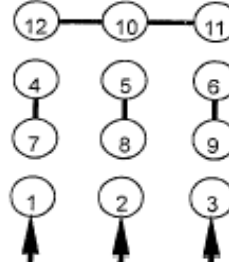

LINE
460 VOLT START

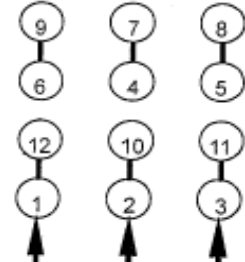

LINE
460 VOLT RUN