

DATE  
MAY 28, 2009  
CATALOG # DTP0206G

OUTLINE DIMENSIONS  
3-PHASE INDUCTION MOTOR

MOTOR TYPE:  
ASGH-SGR  
FRAME NO. 286T

Pole	HP	kW	Hz	VOLT	Syn.Speed r/min(rpm)
6	20	14.9	60	230/460	1200
Ins	Rating	Dimension in	Approx Weight	Bearings	
F	CONT.	inches	364 lbs.	DE: 6311ZZC3 NDE: 6211ZZC3	

Open Protected Drip-Proof Type.Squirrel-cage Rotor.

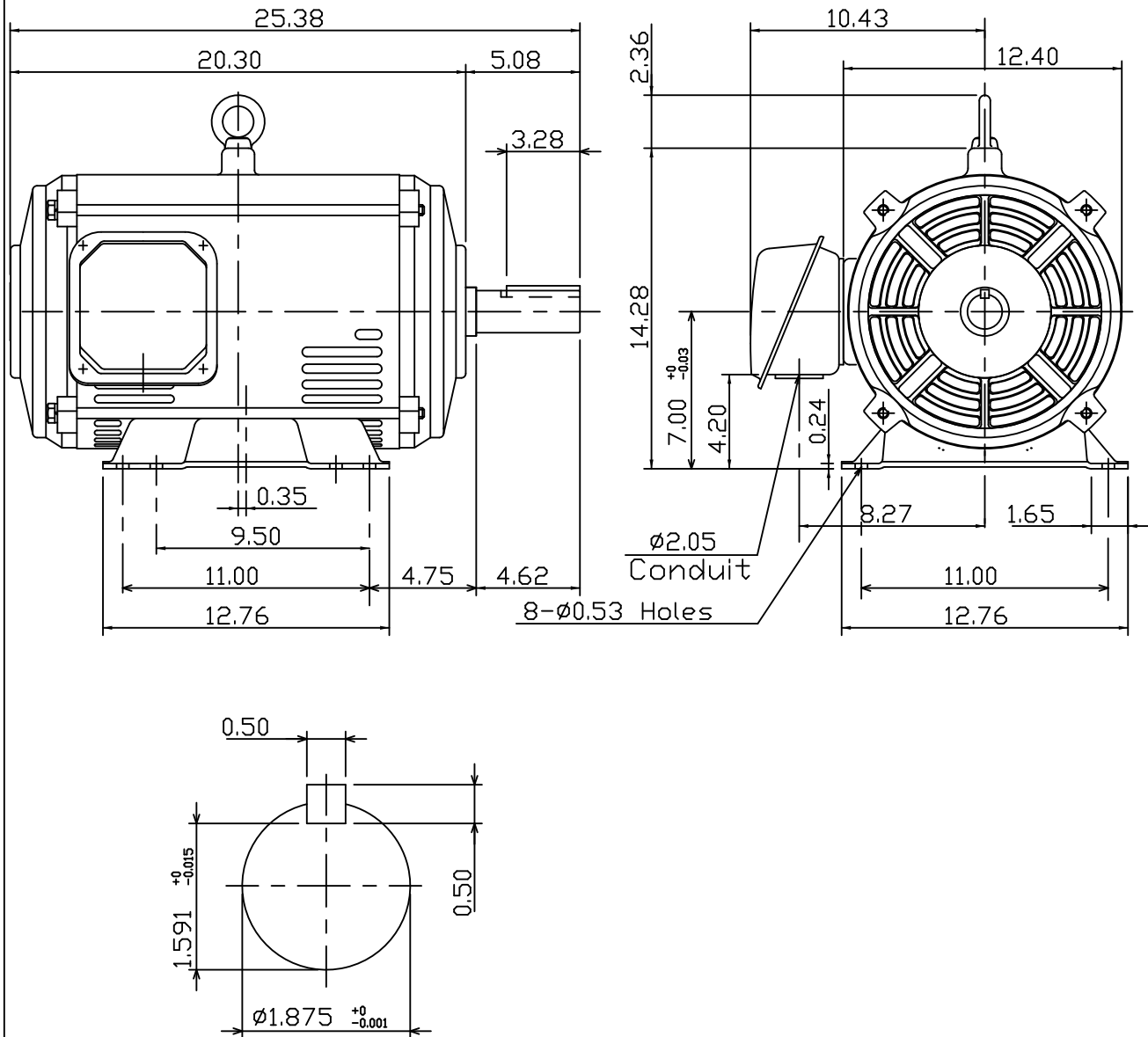

NOTE:  
1.AEGIS Grounding ring installed on Drive-end.



DWN.	K.L.KUD	04-28-08
CHKD.	K.L.KUD	05-05-08
APPD.	M.C.TSAI	05-05-08

TECO Westinghouse

DWG NO.  
31057H724060

# TECO Westinghouse

ISSUED <b>8/18/2015</b>	<b>PERFORMANCE DATA</b>	ENCLOSURE <b>ODP</b>
TYPE <b>ASGH-SGR</b>	<b>3-PHASE INDUCTION MOTOR</b>	CATALOG# <b>DTP0206G</b>

### NAMEPLATE INFORMATION

OUTPUT		POLE	FRAME SIZE	VOLTS	HZ	RATED AMBIENT	INS. CLASS	NEMA DESIGN	TIME RATING	SERVICE FACTOR
HP	KW									
<b>20</b>	<b>14.92</b>	<b>6</b>	<b>286T</b>	<b>230/460</b>	<b>60</b>	<b>40°C</b>	<b>F</b>	<b>B</b>	<b>CONT.</b>	<b>1.15</b>

### TYPICAL PERFORMANCE

FULL LOAD RPM	EFFICIENCY				POWER FACTOR			MAXIMUM POWER FACTOR CORRECTION
	FULL LOAD		3/4 LOAD	1/2 LOAD	FULL LOAD	3/4 LOAD	1/2 LOAD	
	MIN%	NOM%	%	%	%	%	%	
<b>1175</b>	<b>91.7</b>	<b>93.0</b>	<b>94.0</b>	<b>93.5</b>	<b>81.5</b>	<b>77.5</b>	<b>67.0</b>	<b>6.43 KVAR</b>

### CURRENTS

NO LOAD				FULL LOAD				LOCKED ROTOR				NEMA KVA CODE LETTER
AT 200 VOLT	AT 208 VOLT	AT 230 VOLT	AT 460 VOLT	AT 200 VOLT	AT 208 VOLT	AT 230 VOLT	AT 460 VOLT	AT 200 VOLT	AT 208 VOLT	AT 230 VOLT	AT 460 VOLT	
<b>14.4</b>	<b>15.5</b>	<b>19.0</b>	<b>9.5</b>	<b>57.2</b>	<b>55.0</b>	<b>49.7</b>	<b>24.9</b>	<b>252.2</b>	<b>262.3</b>	<b>290.0</b>	<b>145.0</b>	

### TORQUE

### INERTIA

### ACCEL TIME

FULL LOAD lb-ft	LOCKED ROTOR %FLT	PULL UP %FLT	BREAK DOWN %FLT	ROTOR WR <sup>2</sup> lb-ft <sup>2</sup>	NEMA LOAD WK <sup>2</sup> lb-ft <sup>2</sup>	MAX ALLOWABLE WK <sup>2</sup> lb-ft <sup>2</sup>	NEMA LOAD WK <sup>2</sup> Sec.	MAX ALLOWABLE WK <sup>2</sup> Sec.
<b>89.37</b>	<b>225</b>	<b>175</b>	<b>225</b>	<b>8.309</b>	<b>262</b>	<b>786</b>	<b>5.65</b>	<b>16.61</b>

SAFE STALL TIME IN SECONDS		ALLOWABLE STARTS PER HOUR		SOUND PRESSURE LEVEL @ 3 FT dB(A)
COLD	HOT	COLD	HOT	
<b>24</b>	<b>17</b>	<b>2</b>	<b>1</b>	<b>64</b>

APPROVED:	<b>M. PRATER</b>	DRAWING NO.	<b>31057DTP0206G</b>	REV. <b>0</b>
-----------	------------------	-------------	----------------------	---------------

DATE:  
June 14, 2012

# CONNECTION DIAGRAM

DTP0206G

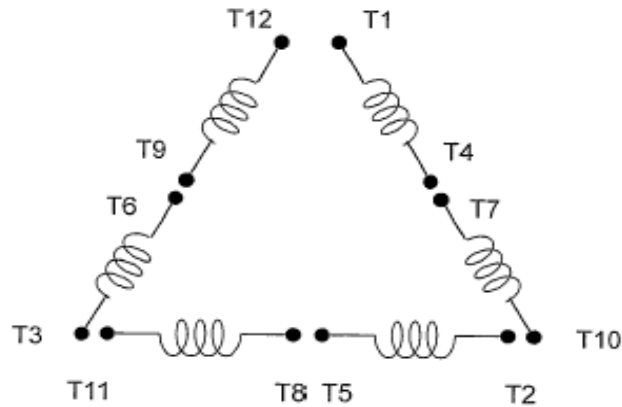

**SCHEMATIC - Δ / Y CONNECTION**

## ACROSS THE LINE CONNECTION

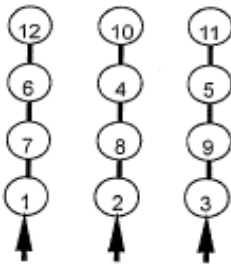

**LINE**  
**230 VOLT CONNECTION**

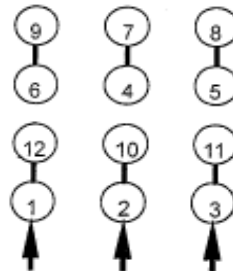

**LINE**  
**460 VOLT CONNECTION**

## WYE START-DELTA RUN CONNECTION

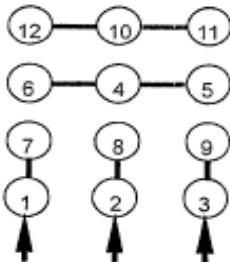

**LINE**  
**230 VOLT START**

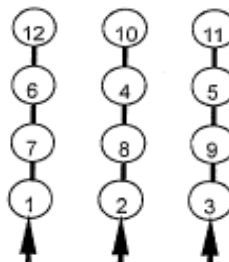

**LINE**  
**230 VOLT RUN**

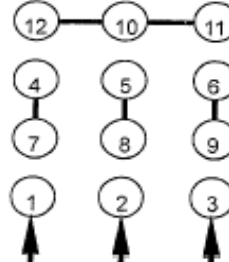

**LINE**  
**460 VOLT START**

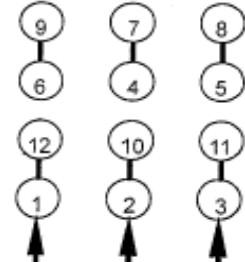

**LINE**  
**460 VOLT RUN**