

DATE
MAY 28, 2009
CATALOG # DTP0254G

OUTLINE DIMENSIONS
3-PHASE INDUCTION MOTOR

MOTOR TYPE:
ASGH-SGR
FRAME NO. 284T

Pole	HP	kW	Hz	VOLT	Syn.Speed r/min(rpm)
4	25	18.6	60	230/460	1800

Ins	Rating	Dimension in	Approx Weight	Bearings
F	CONT.	inches	295 lbs.	DE: 6311ZZC3 NDE: 6211ZZC3

Open Protected Drip-Proof Type.Squirrel-cage Rotor.

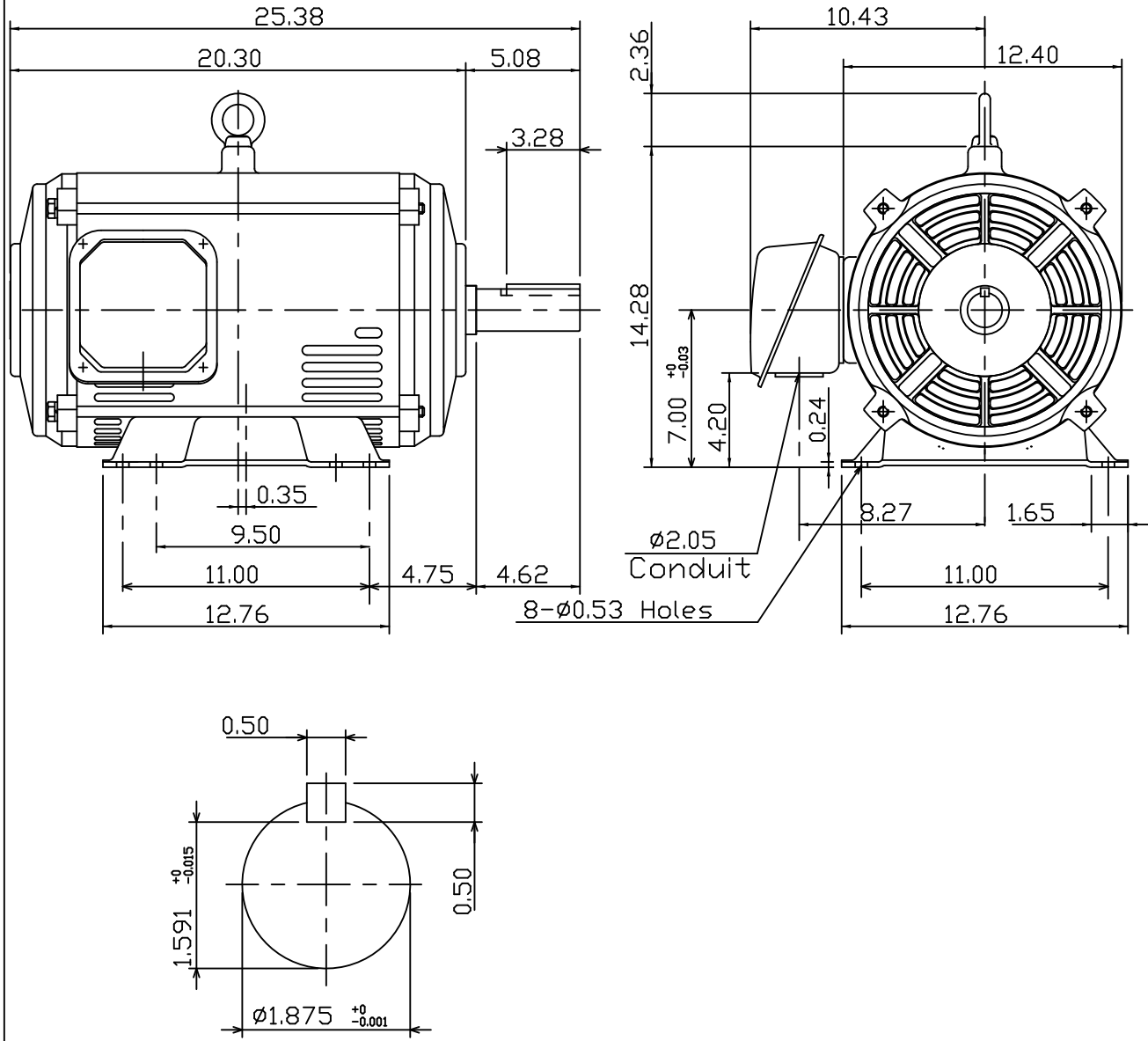

NOTE:
1.AEGIS Grounding ring installed on Drive-end.



DWN.	K.L.KUD	04-28-08
CHKD.	K.L.KUD	05-05-08
APPD.	M.C.TSAI	05-05-08



DWG NO.
31057H724060

TECO Westinghouse

ISSUED 8/18/2015	PERFORMANCE DATA 3-PHASE INDUCTION MOTOR	ENCLOSURE ODP
TYPE ASGH-SGR		CATALOG# DTP0254G

NAMEPLATE INFORMATION

OUTPUT		POLE	FRAME SIZE	VOLTS	HZ	RATED AMBIENT	INS. CLASS	NEMA DESIGN	TIME RATING	SERVICE FACTOR
HP	KW									
25	18.65	4	284T	230/460	60	40°C	F	B	CONT.	1.15

TYPICAL PERFORMANCE

FULL LOAD RPM	EFFICIENCY				POWER FACTOR			MAXIMUM POWER FACTOR CORRECTION
	FULL LOAD		3/4 LOAD	1/2 LOAD	FULL LOAD	3/4 LOAD	1/2 LOAD	
	MIN%	NOM%	%	%	%	%	%	
1765	92.4	93.6	93.5	93.0	85.0	82.0	74.0	6.60 KVAR

CURRENTS

NO LOAD				FULL LOAD				LOCKED ROTOR				NEMA KVA CODE LETTER
AT	AT	AT	AT	AT	AT	AT	AT	AT	AT	AT	AT	
200 VOLT	208 VOLT	230 VOLT	460 VOLT	200 VOLT	208 VOLT	230 VOLT	460 VOLT	200 VOLT	208 VOLT	230 VOLT	460 VOLT	
14.7	15.9	19.5	9.8	67.6	65.0	58.8	29.4	318.3	331.0	366.0	183.0	G

TORQUE

INERTIA

ACCEL TIME

FULL LOAD lb-ft	LOCKED ROTOR %FLT	PULL UP %FLT	BREAK DOWN %FLT	ROTOR WR ² lb-ft ²	NEMA LOAD WK ² lb-ft ²	MAX ALLOWABLE WK ² lb-ft ²	NEMA LOAD WK ² Sec.	MAX ALLOWABLE WK ² Sec.
74.37	210	165	235	3.713	122	366	4.74	13.95

SAFE STALL TIME IN SECONDS		ALLOWABLE STARTS PER HOUR		SOUND PRESSURE LEVEL @ 3 FT dB(A)
COLD	HOT	COLD	HOT	
17	12	2	1	62

APPROVED:	M. PRATER	DRAWING NO.	31057DTP0254G	REV. 0
------------------	------------------	--------------------	----------------------	---------------

DATE:
June 14, 2012

CONNECTION DIAGRAM

DTP0254G



SCHEMATIC - Δ / Y CONNECTION

ACROSS THE LINE CONNECTION

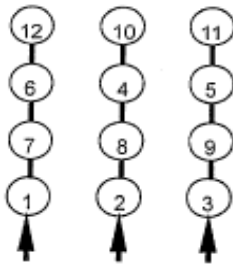

LINE
230 VOLT CONNECTION

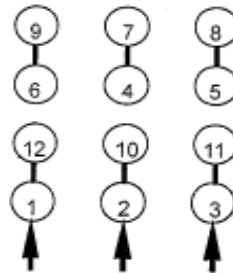

LINE
460 VOLT CONNECTION

WYE START-DELTA RUN CONNECTION

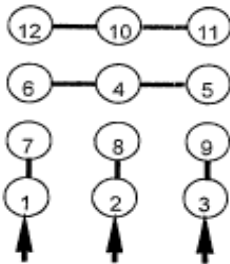

LINE
230 VOLT START

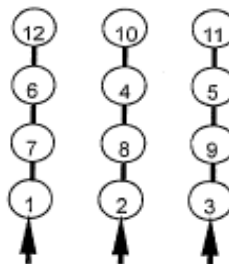

LINE
230 VOLT RUN

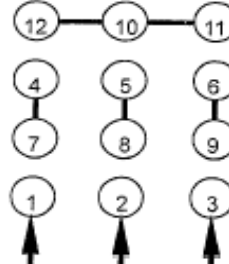

LINE
460 VOLT START

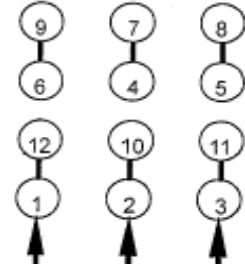

LINE
460 VOLT RUN