

BALDOR® • RELIANCE 

Product Information Packet

EM2515T-8

20HP, 1765RPM, 3PH, 60HZ, 256T, 3948M, OPSB, F1

Part Detail							
Revision:	E	Status:	PRD/A	Change #:		Proprietary:	No
Type:	AC	Elec. Spec:	39WGX981	CD Diagram:	CD0695	Mfg Plant:	
Mech. Spec:	39K57	Layout:	39LYK057	Poles:	04	Created Date:	06-20-2016
Base:	RG	Eff. Date:	10-22-2021	Leads:	6#8		

Specs			
Catalog Number:	EM2515T-8	Inverter Code:	Inverter Ready
Enclosure:	OPSB	KVA Code:	G
Frame:	256T	Lifting Lugs:	Standard Lifting Lugs
Frame Material:	Steel	Locked Bearing Indicator:	No Locked Bearing
Output @ Frequency:	20.000 HP @ 60 HZ	Motor Lead Quantity/Wire Size:	6 @ 8 AWG
Synchronous Speed @ Frequency:	1800 RPM @ 60 HZ	Motor Lead Exit:	Ko Box
Voltage @ Frequency:	200.0 V @ 60 HZ	Motor Lead Termination:	Flying Leads
XP Class and Group:	None	Motor Type:	3948M
XP Division:	Not Applicable	Mounting Arrangement:	F1
Agency Approvals:	CSA	Power Factor:	85
	CSA EEV	Product Family:	General Purpose
	UR	Pulley End Bearing Type:	Ball
Auxillary Box:	No Auxillary Box	Pulley Face Code:	Standard
Auxillary Box Lead Termination:	None	Pulley Shaft Indicator:	Standard
Base Indicator:	Rigid	Rodent Screen:	None
Bearing Grease Type:	Polyrex EM (-20F +300F)	Shaft Extension Location:	Pulley End
Blower:	None	Shaft Ground Indicator:	No Shaft Grounding
Current @ Voltage:	55.000 A @ 200.0 V	Shaft Rotation:	Reversible

Design Code:	A	Shaft Slinger Indicator:	No Slinger
Drip Cover:	No Drip Cover	Speed Code:	Single Speed
Duty Rating:	CONT	Motor Standards:	NEMA
Electrically Isolated Bearing:	Not Electrically Isolated	Starting Method:	Part Winding
Feedback Device:	NO FEEDBACK	Thermal Device - Bearing:	None
Front Face Code:	Standard	Thermal Device - Winding:	None
Front Shaft Indicator:	None	Vibration Sensor Indicator:	No Vibration Sensor
Heater Indicator:	No Heater	Winding Thermal 1:	None
Insulation Class:	F	Winding Thermal 2:	None

Nameplate NP1259L										
CAT.NO.	EM2515T-8									
SPEC.	39K057X981									
HP	20									
VOLTS	200									
AMP	55									
RPM	1765									
FRAME	256T				HZ	60			PH	3
SER.F.	1.15		CODE	G	DES	A		CL	F	
NEMA-NOM-EFF	93		PF	85						
RATING	40C AMB-CONT									
CC	010A				USABLE AT 208V					
DE	6309				ODE	6208				
ENCL	OPSB		SN							

Parts List		
Part Number	Description	Quantity
SA322709	SA 39K057X981	1.000 EA
RA310508	RA 39K057X981	1.000 EA
HA6361A01	LIFTING LUG FOR 37, 39 & 40 FRAME ZINC	2.000 EA
HA6016	ADAPTER, CAST CONDUIT BOX	1.000 EA
09CB3003	CB W/1.75" DIA LD HL - 37, 39, 307 & 309	1.000 EA
51XW2520A12	.25-20 X .75, TAPTITE II, HEX WSHR SLTD	2.000 EA
WD1000B16	T&B CX70TN OR L70P TERMINAL LUG	1.000 EA
59XW2520G07	.25-20X.44,HEX SER WSHR,TAPTITE 2,GREEN	1.000 EA
39EP3200A01SP	FR/PU ENDPLATE, MACH	1.000 EA
HW5100A08	W3118-035 WVY WSHR (WB)	1.000 EA
39EP3201A13	PU ENDPLATE, MACH	1.000 EA
XY3816A12	3/8-16 FINISHED NUT	8.000 EA
09CB3501SP	CONDUIT BOX LID FOR 09CB3001 & 09CB3002	1.000 EA
51XW2520A12	.25-20 X .75, TAPTITE II, HEX WSHR SLTD	2.000 EA
HW2501G25	KEY, 3/8 SQ X 2.875	1.000 EA
LB1115N	LABEL,LIFTING DEVICE (ON ROLLS)	1.000 EA
HA4051A00	PLASTIC CAP FOR GREASE FITTING	1.000 EA
HW4500A03	GREASE FITTING, .125 NPT 1610(ALEMITE) 8	1.000 EA
HW4500A20	1/8NPT SL PIPE PLUG	1.000 EA
MJ1000A02	GREASE, MOBIL POLYREX EM - 124047	0.030 LB
HA4051A00	PLASTIC CAP FOR GREASE FITTING	1.000 EA
HW4500A03	GREASE FITTING, .125 NPT 1610(ALEMITE) 8	1.000 EA
HW4500A20	1/8NPT SL PIPE PLUG	1.000 EA
MG1000Y03	MUNSELL 2.53Y 6.70/ 4.60, GLOSS 20,	0.050 GA

Parts List (continued)		
Part Number	Description	Quantity
85XU0407S04	4X1/4 U DRIVE PIN STAINLESS	2.000 EA
39AD2002A01	BAFFLE PLATE 39 OPEN, SLOTTED BAND MTRS	1.000 EA
39AD2002A01	BAFFLE PLATE 39 OPEN, SLOTTED BAND MTRS	1.000 EA
HA3154A03	STUD, 3/8-16 X 17.75	4.000 EA
LB1119N	WARNING LABEL	1.000 EA
LC0695	CONNECTION LABEL	1.000 EA
NP1259L	ALUM SUPER-E UL CSA-EEV CC NEMA PREMIUM	1.000 EA
39PA1000	PACKAGING GROUP 39 PRINT	1.000 EA
MN416A01	TAG-INSTAL-MAINT no wire (2100/bx) 4/22	1.000 EA
LD7020F06	LEAD SET, 8AWG, 6 LEAD, 20" LONG LEADS	1.000 EA

Accessories		
Part Number	Description	Multiplier
39-3400	C FACE KIT	A8

AC Induction Motor Performance Data

Record # 57709

Typical performance - not guaranteed values

Winding: 39WGX981-R001		Type: 3948M		Enclosure: OPSB	
Nameplate Data			200 V, 60 Hz: Single Voltage Motor		
Rated Output (HP)	20	Full Load Torque	59.8 LB-FT		
Volts	200	Start Configuration	direct on line		
Full Load Amps	55	Breakdown Torque	182 LB-FT		
R.P.M.	1765	Pull-up Torque	76.1 LB-FT		
Hz	60 Phase	3	Locked-rotor Torque	109 LB-FT	
NEMA Design Code	A KVA Code	G	Starting Current	350 A	
Service Factor (S.F.)	1.15	No-load Current	19.6 A		
NEMA Nom. Eff.	93 Power Factor	85	Line-line Res. @ 25°C	0.0886 Ω	
Rating - Duty	40C AMB-CONT		Temp. Rise @ Rated Load	37°C	
S.F. Amps			Temp. Rise @ S.F. Load	46°C	
			Locked-rotor Power Factor	33.3	
			Rotor inertia	2.1 LB-FT ²	

Load Characteristics 200 V, 60 Hz, 20 HP

% of Rated Load	25	50	75	100	125	150	S.F.
Power Factor	51	73	82	85	87	87	86
Efficiency	90.5	93.3	93.5	93.1	92.1	90.8	92.5
Speed	1792	1785	1776	1767	1757	1745	1761
Line amperes	23.5	31.7	42.4	54.5	67.5	81.9	62.3

Performance Graph at 200V, 60Hz, 20.0HP Typical performance - Not guaranteed values

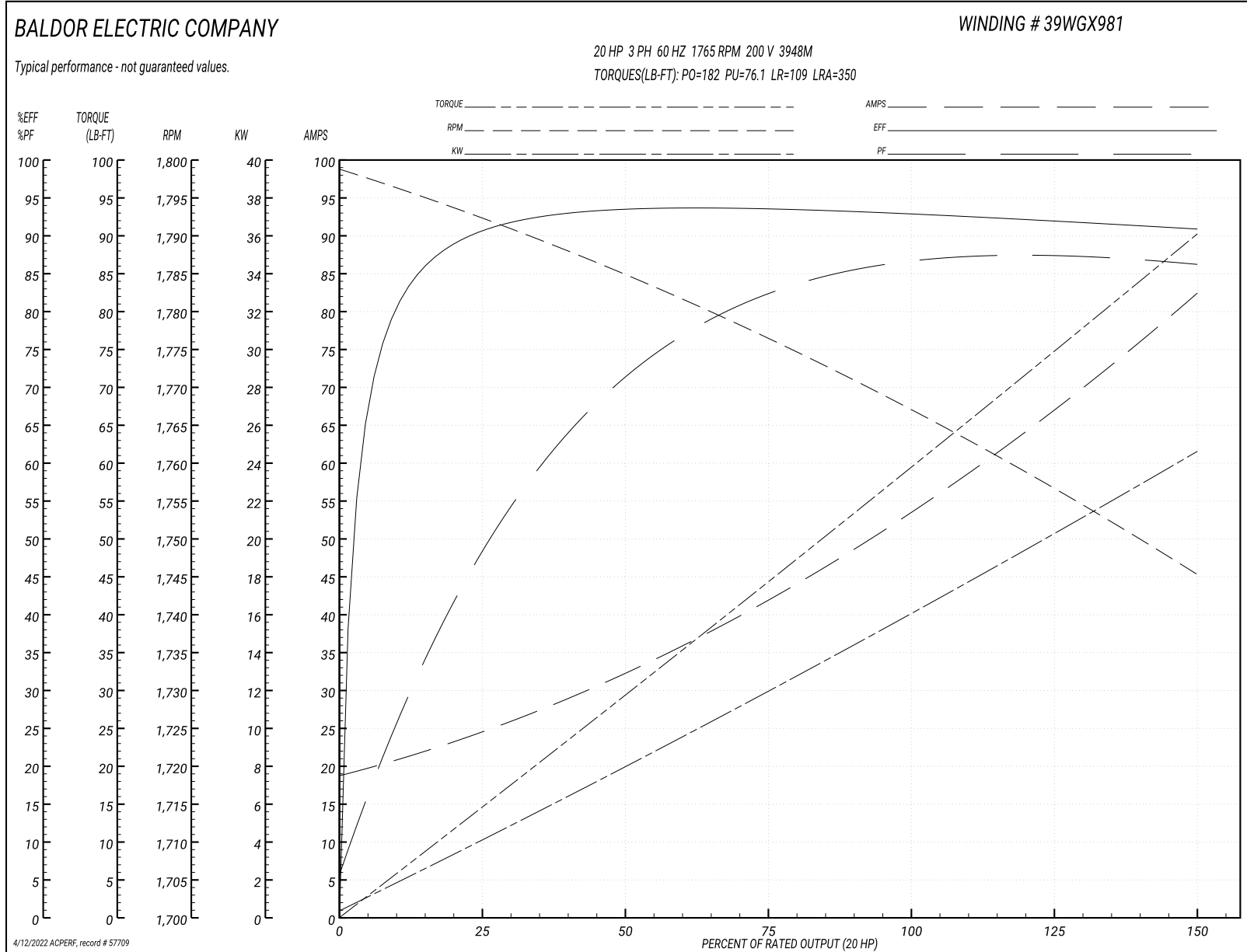

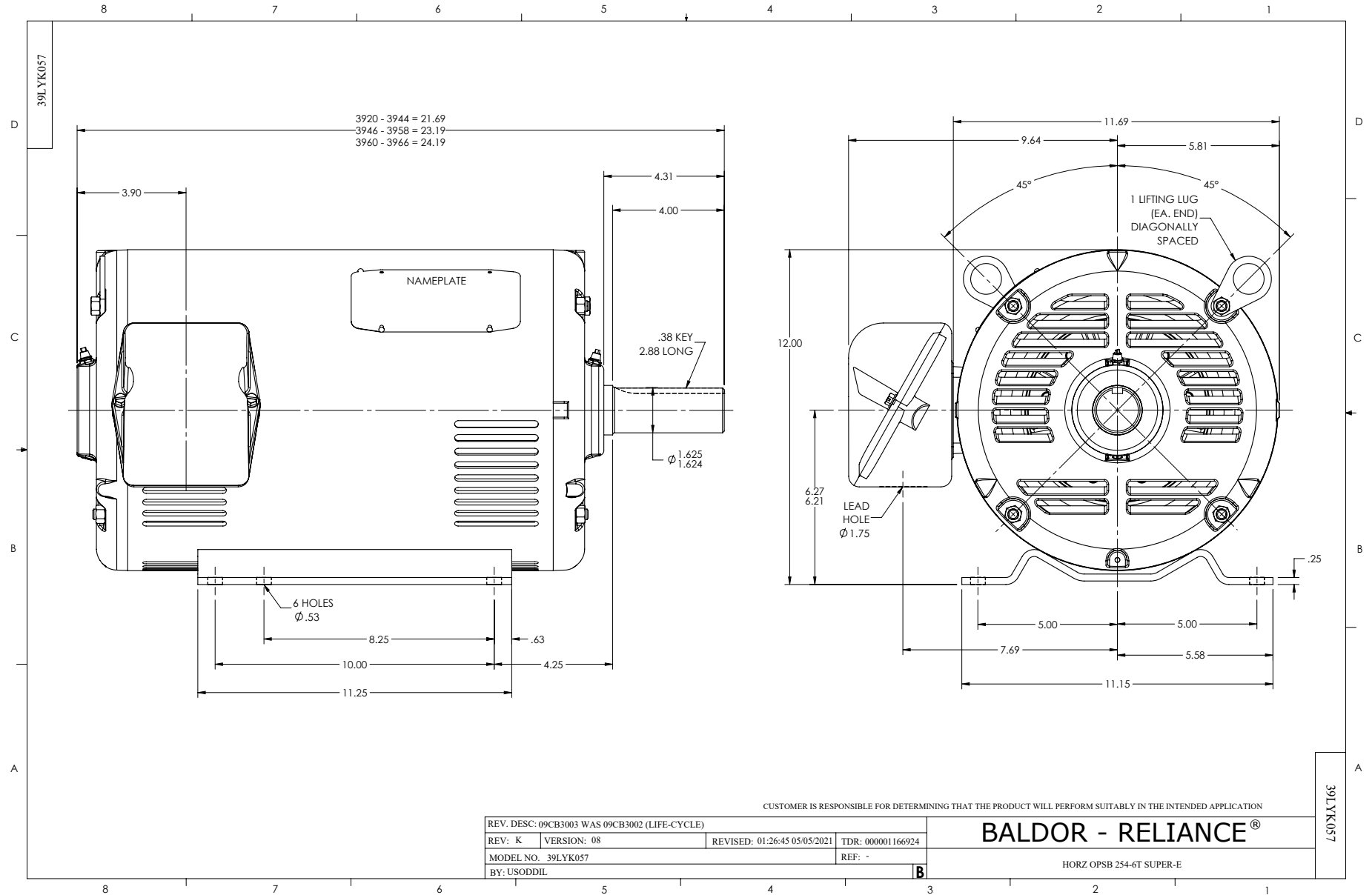

CD0695

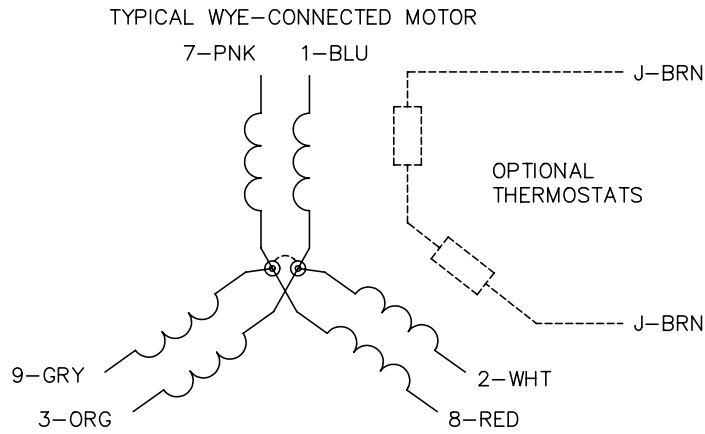

START CONNECTION

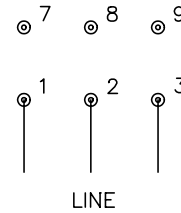

RUN CONNECTION

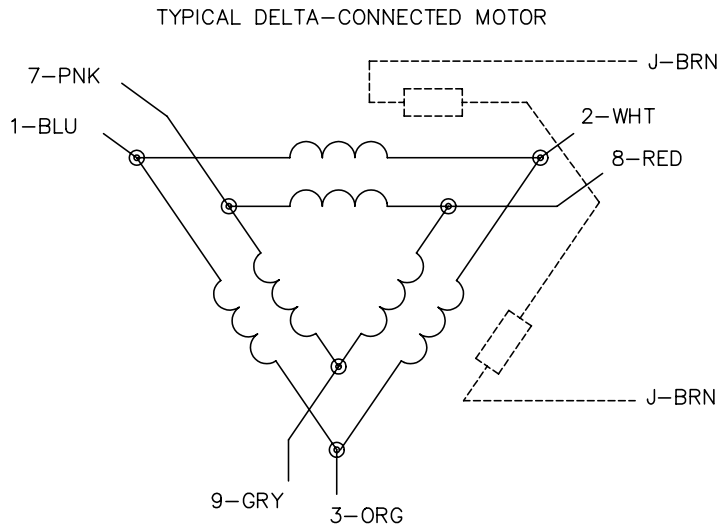
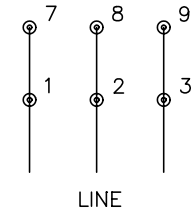

NOTES:

1. MOTOR MAY BE WYE CONNECTED OR DELTA CONNECTED.
2. INTERCHANGE ANY TWO LINE LEADS TO REVERSE ROTATION.
3. OPTIONAL THERMOSTATS ARE PROVIDED WHEN SPECIFIED.
4. ACTUAL NUMBER OF INTERNAL PARALLEL CIRCUITS MAY VARY.
5. LEAD COLORS ARE OPTIONAL. LEADS MUST ALWAYS BE NUMBERED AS SHOWN.

REV. DESC: REVISE TO SHOW OPTIONAL COLORS

REV. LTR: C BY: JLP

REVISED: 01/21/99 3:19

TDR: 0171435

9690D0

FILE: AAA00005151

MDL: -

MTL: -

BALDOR ELECTRIC Co.

3PH, SV, 6 LEADS, PART WINDING START

CD0695

CD0006

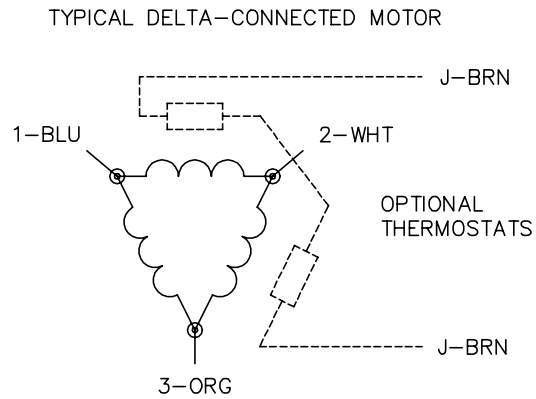
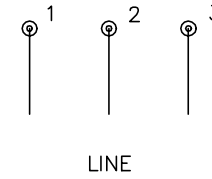
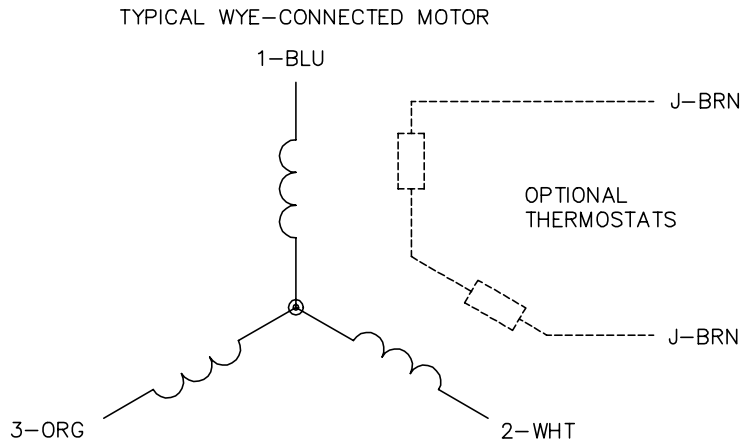

NOTES:

1. THREE LEAD MOTOR MAY BE EITHER WYE CONNECTED OR DELTA CONNECTED.
2. INTERCHANGE ANY TWO LINE LEADS TO REVERSE ROTATION.
3. OPTIONAL THERMOSTATS ARE PROVIDED WHEN SPECIFIED.
4. ACTUAL NUMBER OF INTERNAL PARALLEL CIRCUITS MAY VARY.
5. LEAD COLORS ARE OPTIONAL. LEADS MUST BE NUMBERED AS SHOWN.

CD0006

REV. DESC: ADD CLASS CONN00000007		
REV. LTR: E	VERSION: 01	TDR: 000001099922
FILE: \AAA\00005\141	REVISED: 10:24:49 02/19/2019	BY: ENBRIRO
MTL: -	© □	

BALDOR - RELIANCE®

3PH, SV, 3 LEADS, WYE OR DELTA CONNECTED

SH 1 of 1

Marketing maintained PDF of MN416:

<http://www.baldor.com/support/Literature/Load.ashx/MN416?ManNumber=MN416>