

BALDOR® • RELIANCE 

Product Information Packet

EM3313T

10HP,1770RPM,3PH,60HZ,215T,3742M,OPSB,F1

Part Detail							
Revision:	C	Status:	PRD/A	Change #:		Proprietary:	No
Type:	AC	Elec. Spec:	37WGL868	CD Diagram:	CD0005	Mfg Plant:	
Mech. Spec:	37F614	Layout:	37LYF614	Poles:	04	Created Date:	11-11-2020
Base:	RG	Eff. Date:	06-14-2021	Leads:	9#14		

Specs			
Catalog Number:	EM3313T	Insulation Class:	F
Enclosure:	OPSB	Inverter Code:	Inverter Ready
Frame:	215T	KVA Code:	H
Frame Material:	Steel	Lifting Lugs:	Standard Lifting Lugs
Output @ Frequency:	10.000 HP @ 60 HZ	Locked Bearing Indicator:	No Locked Bearing
Synchronous Speed @ Frequency:	1800 RPM @ 60 HZ	Motor Lead Quantity/Wire Size:	9 @ 14 AWG
Voltage @ Frequency:	460.0 V @ 60 HZ	Motor Lead Exit:	Ko Box
	230.0 V @ 60 HZ	Motor Lead Termination:	Flying Leads
XP Class and Group:	None	Motor Type:	3742M
XP Division:	Not Applicable	Mounting Arrangement:	F1
Agency Approvals:	UR	Power Factor:	82
	CSA EEV	Product Family:	General Purpose
	CSA	Pulley End Bearing Type:	Ball
Auxillary Box:	No Auxillary Box	Pulley Face Code:	Standard
Auxillary Box Lead Termination:	None	Pulley Shaft Indicator:	Standard
Base Indicator:	Rigid	Rodent Screen:	None
Bearing Grease Type:	Polyrex EM (-20F +300F)	RoHS Status:	ROHS COMPLIANT
Blower:	None	Shaft Extension Location:	Pulley End

Current @ Voltage:	12.500 A @ 460.0 V	Shaft Ground Indicator:	No Shaft Grounding
	25.000 A @ 230.0 V	Shaft Rotation:	Reversible
	26.400 A @ 208.0 V	Shaft Slinger Indicator:	No Slinger
Design Code:	B	Speed Code:	Single Speed
Drip Cover:	No Drip Cover	Motor Standards:	NEMA
Duty Rating:	CONT	Starting Method:	Direct on line
Electrically Isolated Bearing:	Not Electrically Isolated	Thermal Device - Bearing:	None
Feedback Device:	NO FEEDBACK	Thermal Device - Winding:	None
Front Face Code:	Standard	Vibration Sensor Indicator:	No Vibration Sensor
Front Shaft Indicator:	None	Winding Thermal 1:	None
Heater Indicator:	No Heater	Winding Thermal 2:	None

Nameplate NP3553LUA										
CAT.NO.	EM3313T									
SPEC.	37F614L868									
HP	10									
VOLTS	230/460									
AMPS	25/12.5									
RPM	1770									
FRAME	215T				HZ	60			PH	3
SF	1.15		CODE	H	DES	B		CLASS	F	
NEMA NOM. EFF	91.7		PF	82						
RATING	40C AMB-CONT									
CC	010A				USABLE AT 208V					26.4
DE	6307				ODE	6206				
ENCL	OPSB		SN							
VPWM INVERTER READY										
CT30-60(2:1) VT3-60(20:1)										
USABLE AT	50HZ 7.5HP 190/380V 23.4/11.7A								SF1.0	

Parts List		
Part Number	Description	Quantity
SA387943	SA 37F614L868	1.000 EA
RA378283	RA 37F614L868	1.000 EA
HA6361A01	LIFTING LUG FOR 37, 39 & 40 FRAME ZINC	2.000 EA
37CB3006	37 CB CASTING W/1.38 LEAD HOLE @ 6:00	1.000 EA
51XW2520A10	.25-20 X .62, TAPTITE II, HEX WSHR SLTD	2.000 EA
11XW1032G06	10-32 X .38, TAPTITE II, HEX WSHR SLTD U	1.000 EA
37EP3203A00	MASTER,ODE,206 BRG,GREASER	1.000 EA
HW4500A01	1641B(ALEMITE)400 UNIV, GREASE FITT	1.000 EA
HW5100A06	W2420-025 WVY WSHR (WB)	1.000 EA
37EP3204D00	MASTER,DE,307 BRG,GREASER	1.000 EA
HW4500A01	1641B(ALEMITE)400 UNIV, GREASE FITT	1.000 EA
XY3118A12	5/16-18 HEX NUT DIRECTIONAL SERRATION	4.000 EA
37CB4516	LIPPED LID FOR 37 FRAME NEC KOBX	1.000 EA
51XW0832A07	8-32 X .44, TAPTITE II, HEX WSHR SLTD SE	4.000 EA
HW2501F21	KEY, 5/16 SQ X 2.375	1.000 EA
85XU0407S04	4X1/4 U DRIVE PIN STAINLESS	2.000 EA
LB1115N	LABEL,LIFTING DEVICE (ON ROLLS)	1.000 EA
MJ1000A02	GREASE, MOBIL POLYREX EM - 124047	0.050 LB
HA3104A35	THRUBOLT .31-18 X 13.687	4.000 EA
37AD2001A01	BAFFLE PLATE, PLASTIC 0.63" WIDTH	2.000 EA
MG1000Y03	MUNSELL 2.53Y 6.70/ 4.60, GLOSS 20,	0.028 GA
LC0005E01	CONN.DIA./WARNING LABEL (LC0005/LB1119N)	1.000 EA
NP3553LUA	ALUM SUPER-E VPWM INVERTER READY UL	1.000 EA
36PA1001	PKG GRP, PRINT PK1017A06	1.000 EA

Parts List (continued)		
Part Number	Description	Quantity
MN416A01	TAG-INSTAL-MAINT no wire (2100/bx) 4/22	1.000 EA
FE-0000001	ZRTG FE ASSEMBLY	1.000 EA
PE-0000001	ZRTG PE ASSEMBLY	1.000 EA

Accessories		
Part Number	Description	Multiplier
37-1404	C FACE KIT	A8

AC Induction Motor Performance Data

Record # 85454

Preliminary Data Sheet

Winding: 37WGL868-RXXX		Type: 3742M		Enclosure: OPSB	
Nameplate Data			460 V, 60 Hz: High Voltage Connection		
Rated Output (HP)	10	Full Load Torque	29.8 LB-FT		
Volts	230/460	Start Configuration	direct on line		
Full Load Amps	25.0/12.5	Breakdown Torque	101 LB-FT		
R.P.M.	1770	Pull-up Torque	44.9 LB-FT		
Hz	60 Phase	Locked-rotor Torque	56 LB-FT		
NEMA Design Code	B	Starting Current	88.6 A		
Service Factor (S.F.)	1.15	No-load Current	5.31 A		
NEMA Nom. Eff.	91.7	Line-line Res. @ 25°C	1.18 Ω		
Rating - Duty	40C AMB-CONT	Temp. Rise @ Rated Load	35°C		
S.F. Amps	28.0/14.0	Temp. Rise @ S.F. Load	44°C		
		Locked-rotor Power Factor	42.6		
		Rotor inertia	1.03 lb-ft ²		

Load Characteristics 460 V, 60 Hz, 10 HP

% of Rated Load	25	50	75	100	125	150	S.F.
Power Factor	45	67	77	82	84	85	84
Efficiency	86.7	91.3	92.1	91.7	90.9	89.6	91.1
Speed	1792	1785	1777	1769	1760	1750	1762
Line amperes	6.04	7.69	9.84	12.4	15.3	18.4	14.1

Performance Graph at 460V, 60Hz, 10.0HP Typical performance - Not guaranteed values

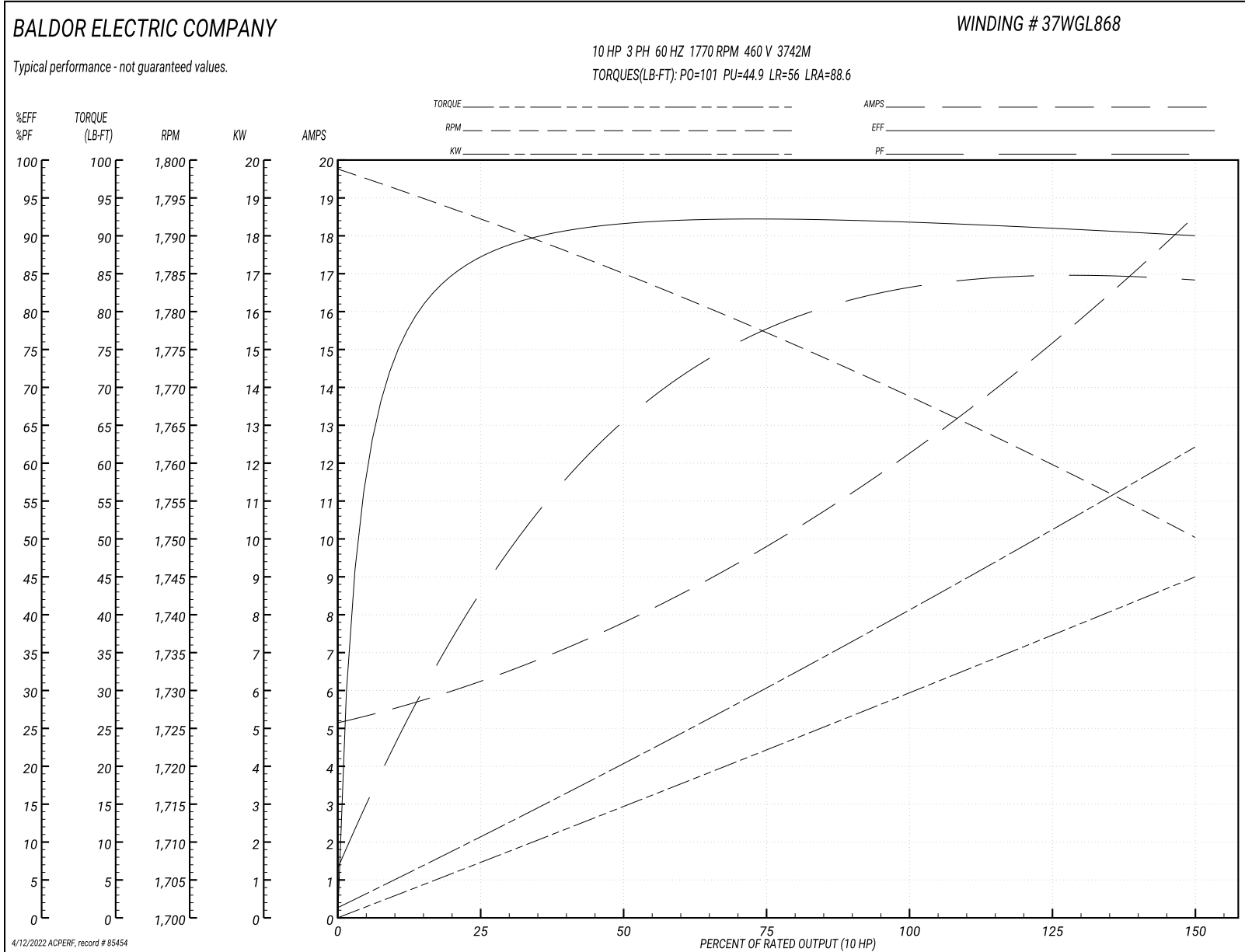

37LYF614

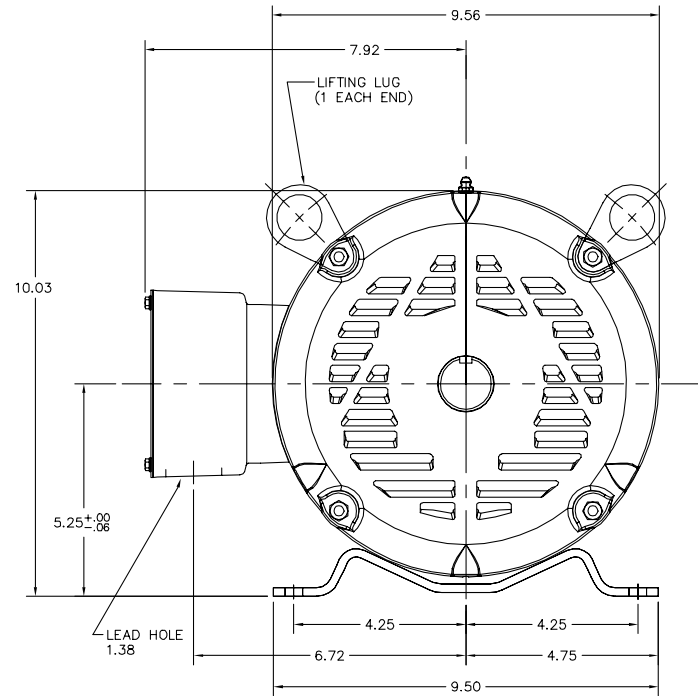
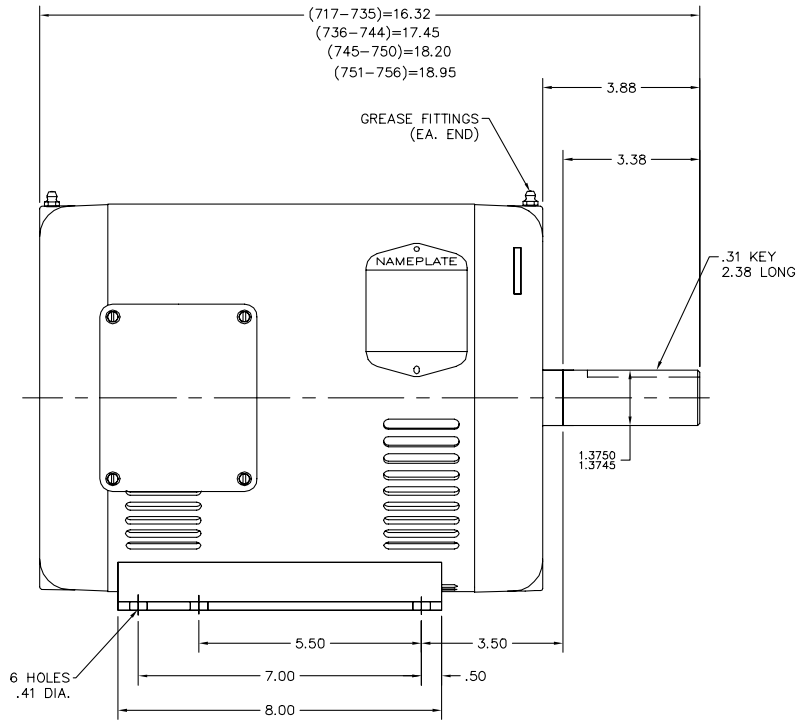

37LYF614

CUSTOMER IS RESPONSIBLE FOR DETERMINING THAT BALDOR'S PRODUCT WILL PERFORM SUITABLY IN THE INTENDED APPLICATION.

REV. DESC: REPLACE ENDPLATES		
REV. LTR: H	VERSION: 03	TDR: 000001018975
FILE: \AAA\00018\745	REVISED: 09:54:18 03/07/2017	BY: USZAHAR
MTL: -		

BALDOR

STD HORZ 213-5T OPSB 37M (SUPER-E)

SH 1 of 1

CD0005



LOW VOLTAGE
(2Y)



LINE

HIGH VOLTAGE
(1Y)

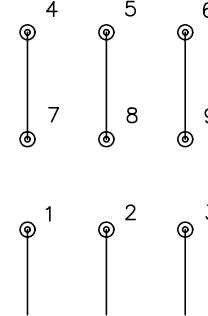

LINE

NOTES:

1. INTERCHANGE ANY TWO LINE LEADS TO REVERSE ROTATION.
2. OPTIONAL THERMOSTATS ARE PROVIDED WHEN SPECIFIED.
3. ACTUAL NUMBER OF INTERNAL PARALLEL CIRCUITS MAY BE A MULTIPLE OF THOSE SHOWN ABOVE.
4. LEAD COLORS ARE OPTIONAL. LEADS MUST ALWAYS BE NUMBERED AS SHOWN.

REV. DESC: REVISE TO SHOW OPTIONAL COLORS			
REV. LTR: E	BY: JLP	REVISED: 01/19/99 10:15	TDR: 0171435
90000		FILE: AAA00005140	MDL: -
		MTL: -	

BALDOR ELECTRIC Co.

3PH, DV, 9 LEADS

CD0005