

BALDOR® • RELIANCE 

Product Information Packet

EM3711T

10HP,3490RPM,3PH,60HZ,215T,3728M,TEFC,F1

Part Detail							
Revision:	Q	Status:	PRD/A	Change #:		Proprietary:	No
Type:	AC	Elec. Spec:	37WGS864	CD Diagram:	CD0005	Mfg Plant:	
Mech. Spec:	37H244	Layout:	37LYH244	Poles:	02	Created Date:	01-03-2011
Base:	RG	Eff. Date:	07-18-2019	Leads:	9#14		

Specs			
Catalog Number:	EM3711T	Insulation Class:	F
Enclosure:	TEFC	Inverter Code:	Inverter Duty
Frame:	215T	KVA Code:	G
Frame Material:	Steel	Lifting Lugs:	Standard Lifting Lugs
Output @ Frequency:	10.000 HP @ 60 HZ	Locked Bearing Indicator:	No Locked Bearing
Synchronous Speed @ Frequency:	3600 RPM @ 60 HZ	Motor Lead Quantity/Wire Size:	9 @ 14 AWG
Voltage @ Frequency:	460.0 V @ 60 HZ	Motor Lead Exit:	Ko Box
	230.0 V @ 60 HZ	Motor Lead Termination:	Flying Leads
XP Class and Group:	None	Motor Type:	3730M
XP Division:	Not Applicable	Mounting Arrangement:	F1
Agency Approvals:	UR	Power Factor:	88
	CSA EEV	Product Family:	General Purpose
	CSA	Pulley End Bearing Type:	Ball
Auxillary Box:	No Auxillary Box	Pulley Face Code:	Standard
Auxillary Box Lead Termination:	None	Pulley Shaft Indicator:	Standard
Base Indicator:	Rigid	Rodent Screen:	None
Bearing Grease Type:	Polyrex EM (-20F +300F)	RoHS Status:	ROHS COMPLIANT
Blower:	None	Shaft Extension Location:	Pulley End

Current @ Voltage:	11.600 A @ 460.0 V	Shaft Ground Indicator:	No Shaft Grounding
	23.200 A @ 230.0 V	Shaft Rotation:	Reversible
	24.900 A @ 208.0 V	Shaft Slinger Indicator:	No Slinger
Design Code:	B	Speed Code:	Single Speed
Drip Cover:	No Drip Cover	Motor Standards:	NEMA
Duty Rating:	CONT	Starting Method:	Direct on line
Electrically Isolated Bearing:	Not Electrically Isolated	Thermal Device - Bearing:	None
Feedback Device:	NO FEEDBACK	Thermal Device - Winding:	None
Front Face Code:	Standard	Vibration Sensor Indicator:	No Vibration Sensor
Front Shaft Indicator:	None	Winding Thermal 1:	None
Heater Indicator:	No Heater	Winding Thermal 2:	None

Nameplate NP3441LUA										
CAT.NO.	EM3711T									
SPEC	37H244S864G2									
HP	10									
VOLTS	230/460									
AMPS	23.2/11.6									
RPM	3490									
FRAME	215T				HZ	60			PH	3
SF	1.15		CODE	G	DES	B		CLASS	F	
NEMA NOM. EFF	90.2		PF	88						
RATING	40C AMB-CONT									
CC	010A				USABLE AT 208V					24.9
ENCL	TEFC		SER							
DE	6307			ODE	6206					
VPWM INVERTER READY										
CT6-60H(10:1)VT3-60H(20:1										
	50Hz 10HP 190/380V 28.2/14.1A								SF1.0	

Parts List		
Part Number	Description	Quantity
SA214702	SA 37H244S864G2	1.000 EA
RA201904	RA 37H244S864G2	1.000 EA
36FN3000C02SP	EXFN, PLASTIC, 5.25 OD, 1.175 ID	1.000 EA
HW3200A01	3/8-16X3/4 I-BLT WELDED F/S	1.000 EA
37CB3006	37 CB CASTING W/1.38 LEAD HOLE @ 6:00	1.000 EA
37GS1000SP	GASKET, CONDUIT BOX STD., .06 THICK LEXI	1.000 EA
51XW2520A12	.25-20 X .75, TAPTITE II, HEX WSHR SLTD	2.000 EA
11XW1032G06	10-32 X .38, TAPTITE II, HEX WSHR SLTD U	1.000 EA
37EP3101A01	FR ENDPLATE, FOR ROUTING PURPOSES	1.000 EA
HW4500A01	1641B(ALEMITE)400 UNIV, GREASE FITT	1.000 EA
HW5100A06	W2420-025 WVY WSHR (WB)	1.000 EA
37EP3100A01	PUEP ASSEMBLY - ROUTING PUPROSES	1.000 EA
HW4500A01	1641B(ALEMITE)400 UNIV, GREASE FITT	1.000 EA
XY3118A12	5/16-18 HEX NUT DIRECTIONAL SERRATION	4.000 EA
07FH4007SP	PRIMED	1.000 EA
51XW1032A06	10-32 X .38, TAPTITE II, HEX WSHR SLTD S	3.000 EA
37CB4516	LIPPED LID FOR 37 FRAME NEC KOBX	1.000 EA
37GS1008	37 GS FOR CB LID - LEXIDE	1.000 EA
51XW0832A07	8-32 X .44, TAPTITE II, HEX WSHR SLTD SE	4.000 EA
HW2501F21	KEY, 5/16 SQ X 2.375	1.000 EA
HA7000A02	KEY RETAINER RING, 1 1/8 DIA, 1 3/8 DIA	1.000 EA
85XU0407S04	4X1/4 U DRIVE PIN STAINLESS	2.000 EA
LB1115N	LABEL,LIFTING DEVICE (ON ROLLS)	1.000 EA
MJ1000A02	GREASE, MOBIL POLYREX EM - 124047	0.050 LB

Parts List (continued)		
Part Number	Description	Quantity
51XB1214A20	12-14X1.25 HXWSSLD SERTYB	1.000 EA
HA3104A14	THRUBOLT- 5/16-18 X12.125(OHIO)	4.000 EA
MG1000Y03	MUNSELL 2.53Y 6.70/ 4.60, GLOSS 20,	0.028 GA
LC0005E01	CONN.DIA./WARNING LABEL (LC0005/LB1119N)	1.000 EA
NP3441LUA	ALUM SUPER-E VPWM INV READY UL CSA-EEV C	1.000 EA
G0PA1000	PKG GRP, PRINT PK1026A06	1.000 EA
MN416A01	TAG-INSTAL-MAINT no wire (2100/bx) 4/22	1.000 EA

Accessories		
Part Number	Description	Multiplier
37-1304	C FACE KIT	A8

AC Induction Motor Performance Data

Record # 53399

Typical performance - not guaranteed values

Winding: 37WGS864-R028		Type: 3730M		Enclosure: TEFC	
Nameplate Data			460 V, 60 Hz: High Voltage Connection		
Rated Output (HP)	10	Full Load Torque	14.94 LB-FT		
Volts	230/460	Start Configuration	direct on line		
Full Load Amps	23.2/11.6	Breakdown Torque	46.1 LB-FT		
R.P.M.	3490	Pull-up Torque	19.3 LB-FT		
Hz	60 Phase	3	Locked-rotor Torque	23.7 LB-FT	
NEMA Design Code	B KVA Code	G	Starting Current	77.3 A	
Service Factor (S.F.)	1.15	No-load Current	3.66 A		
NEMA Nom. Eff.	90.2	Power Factor	88	Line-line Res. @ 25°C	1.05 Ω
Rating - Duty	40C AMB-CONT		Temp. Rise @ Rated Load	78°C	
S.F. Amps			Temp. Rise @ S.F. Load	97°C	
			Locked-rotor Power Factor	33.7	
			Rotor inertia	0.273 LB-FT ²	

Load Characteristics 460 V, 60 Hz, 10 HP

% of Rated Load	25	50	75	100	125	150	S.F.
Power Factor	57	78	85	88	90	89	88
Efficiency	88.6	91.7	91.6	90.6	89.1	87.3	90
Speed	3573	3548	3520	3489	3455	3417	3464
Line amperes	4.56	6.49	8.9	11.6	14.6	17.9	13.5

Performance Graph at 460V, 60Hz, 10.0HP Typical performance - Not guaranteed values

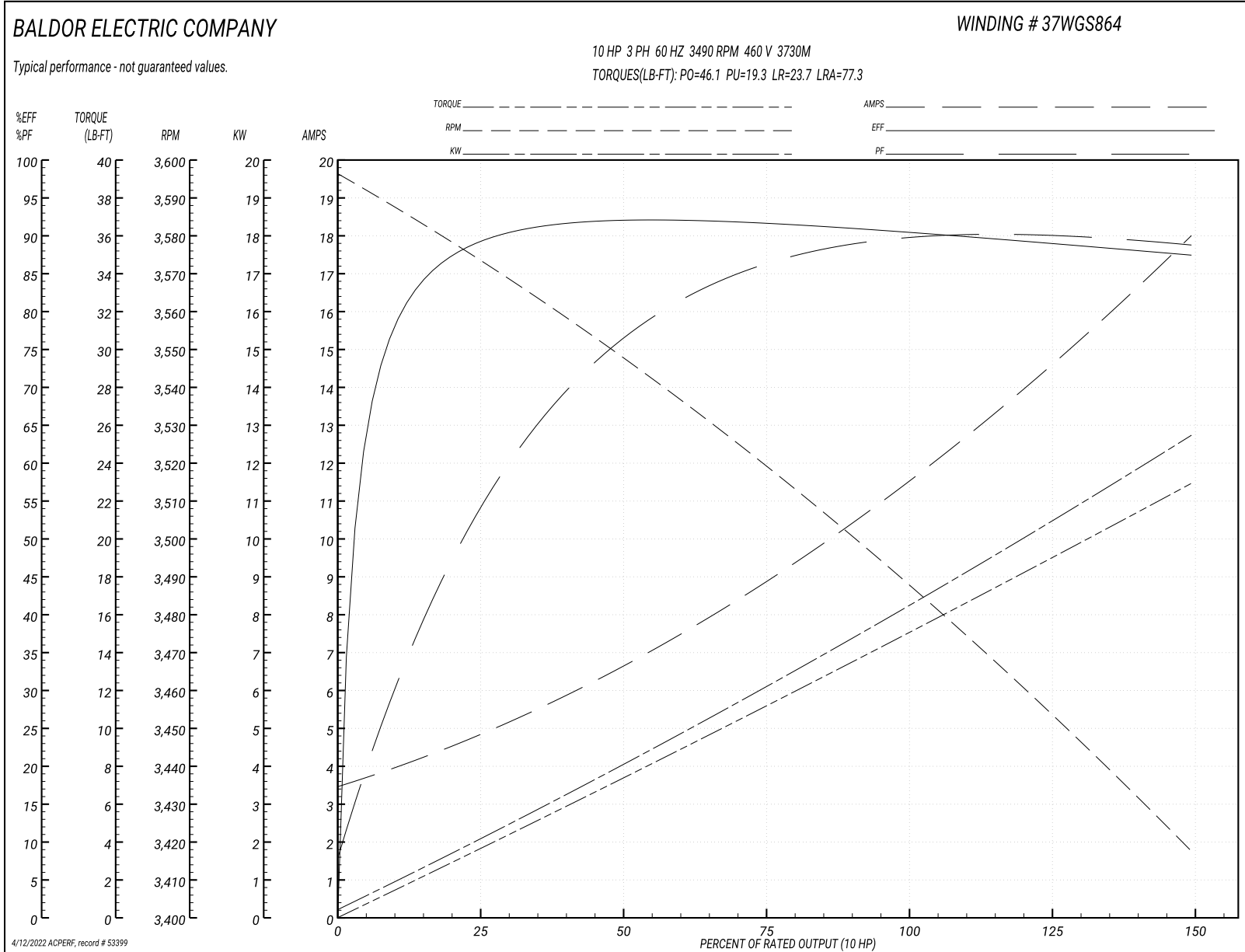

AC Induction Motor Performance Data

Record # 59174

Typical performance - not guaranteed values

Winding: 37WGS864-R028		Type: 3728M		Enclosure: TEFC	
Nameplate Data			230 V, 60 Hz: Low Voltage Connection		
Rated Output (HP)	10	Full Load Torque	15 LB-FT		
Volts	230/460	Start Configuration	direct on line		
Full Load Amps	23.6/11.8	Breakdown Torque	45.7 LB-FT		
R.P.M.	3490	Pull-up Torque	21.9 LB-FT		
Hz	60 Phase	3	Locked-rotor Torque	25.4 LB-FT	
NEMA Design Code	B KVA Code	G	Starting Current	152 A	
Service Factor (S.F.)	1.15	No-load Current	8.25 A		
NEMA Nom. Eff.	90.2	Power Factor	87	Line-line Res. @ 25°C	0.248 Ω
Rating - Duty	40C AMB-CONT		Temp. Rise @ Rated Load	79°C	
S.F. Amps			Temp. Rise @ S.F. Load	98°C	
			Locked-rotor Power Factor	33.1	
			Rotor inertia	0.255 LB-FT ²	

Load Characteristics 230 V, 60 Hz, 10 HP

% of Rated Load	25	50	75	100	125	150	S.F.
Power Factor	53	74	84	87	88	89	88
Efficiency	86.7	91	91.4	90.6	89.1	87.3	90
Speed	3575	3547	3516	3482	3445	3401	3464
Line amperes	9.88	13.7	18.2	23.6	29.5	36	27.1

Performance Graph at 230V, 60Hz, 10.0HP Typical performance - Not guaranteed values

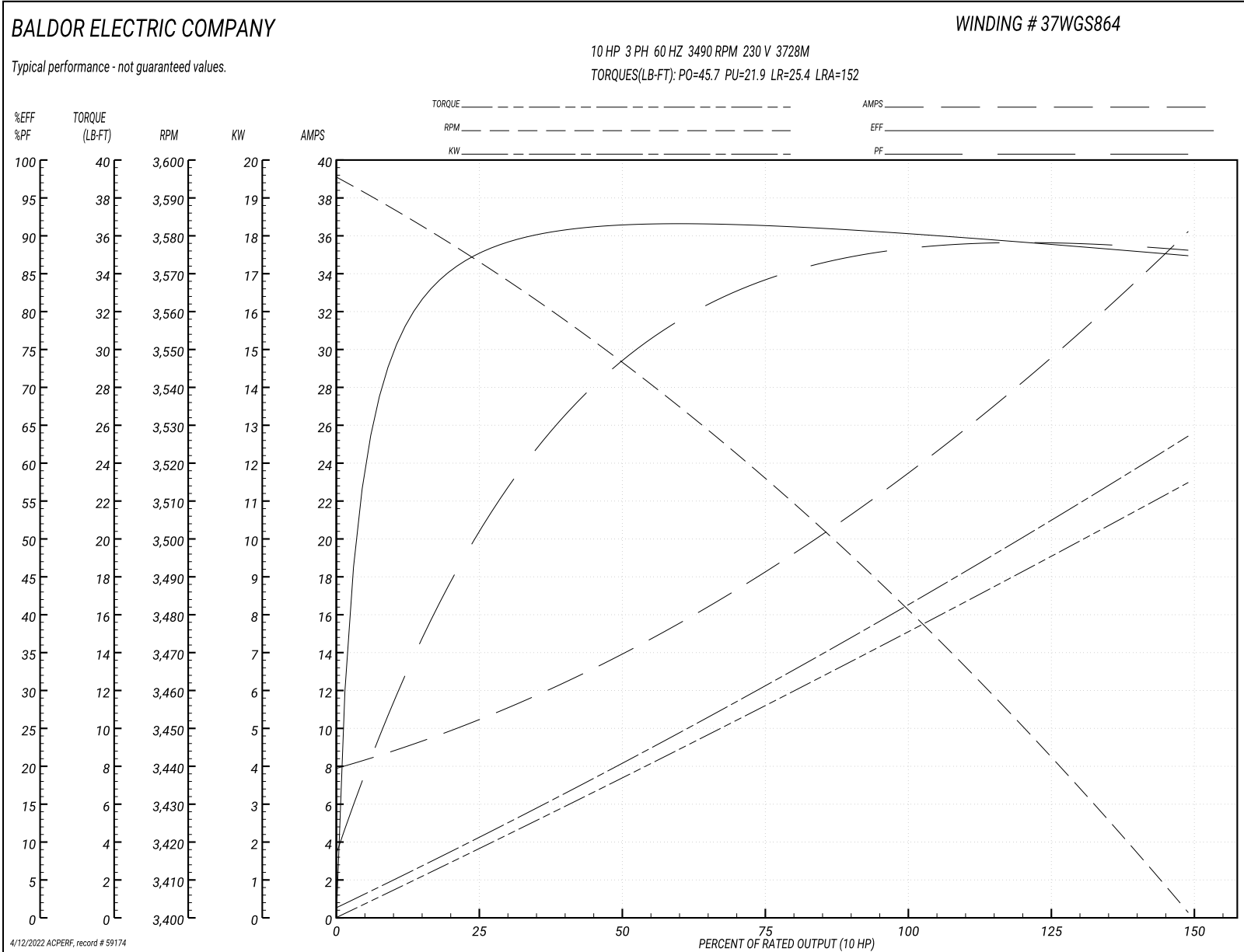

AC Induction Motor Performance Data

Record # 69805

Typical performance - not guaranteed values

Winding: 37WGS864-R028		Type: 3728M		Enclosure: TEFC	
Nameplate Data			480 V, 60 Hz: High Voltage Connection		
Rated Output (HP)	10	Full Load Torque	14.97 LB-FT		
Volts	230/460	Start Configuration	direct on line		
Full Load Amps	23.6/11.8	Breakdown Torque	50.07 LB-FT		
R.P.M.	3490	Pull-up Torque	24.32 LB-FT		
Hz	60 Phase	3	Locked-rotor Torque	28.21 LB-FT	
NEMA Design Code	B KVA Code	G	Starting Current	80.47 A	
Service Factor (S.F.)	1.15	No-load Current	4.85 A		
NEMA Nom. Eff.	90.2	Power Factor	87	Line-line Res. @ 25°C	0.991 Ω
Rating - Duty	40C AMB-CONT		Temp. Rise @ Rated Load	78°C	
S.F. Amps			Temp. Rise @ S.F. Load	97°C	
			Locked-rotor Power Factor	33.1	
			Rotor inertia	0.255 LB-FT ²	

Load Characteristics 480 V, 60 Hz, 10 HP

% of Rated Load	25	50	75	100	125	150	S.F.
Power Factor	46	67	78	83	86	87	85
Efficiency	85.9	90.5	91.2	90.5	89.3	87.6	89.8
Speed	3577	3550	3521	3489	3454	3414	3468
Line amperes	5.56	7.29	9.34	11.81	14.5	17.52	13.4

Performance Graph at 480V, 60Hz, 10.0HP Typical performance - Not guaranteed values

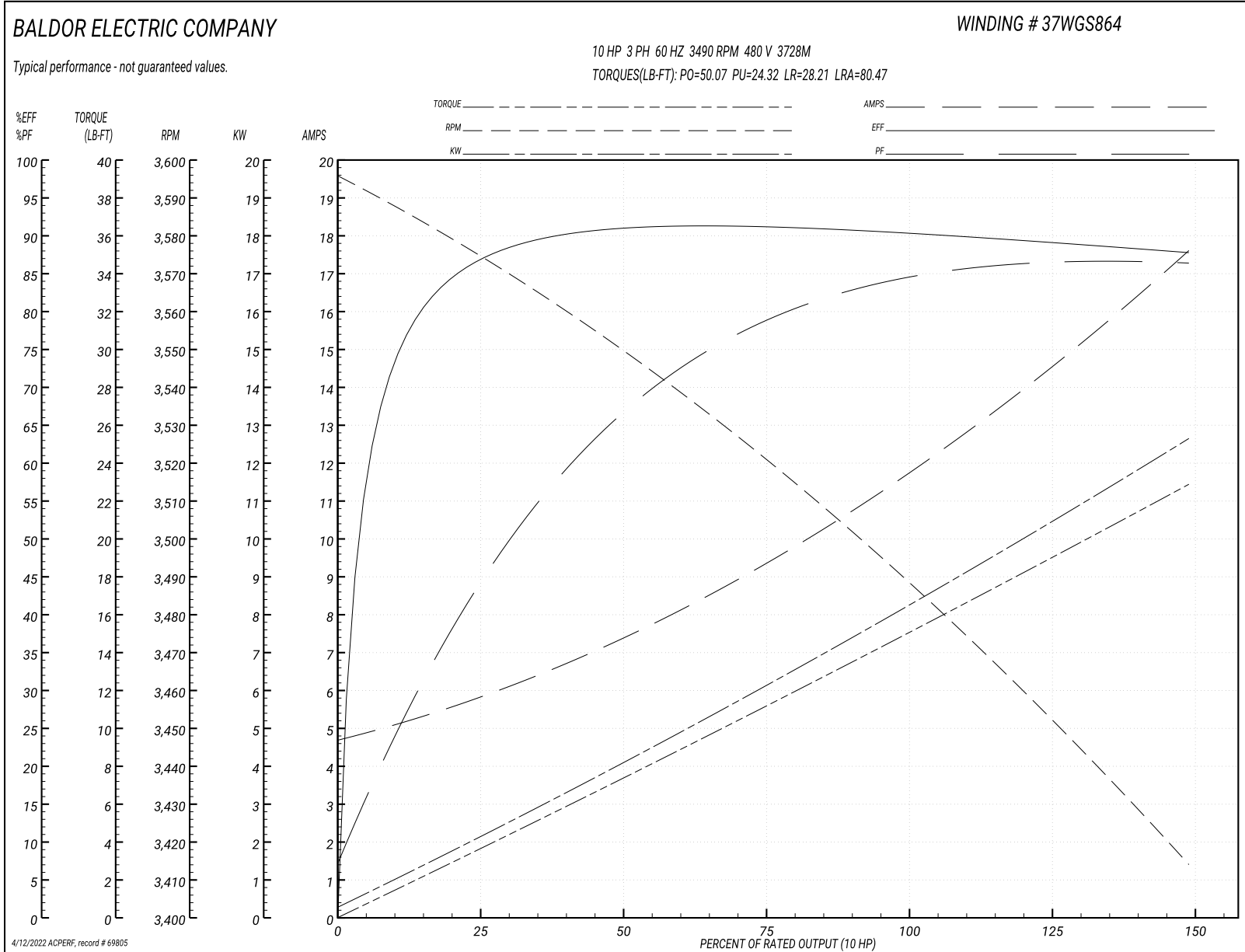

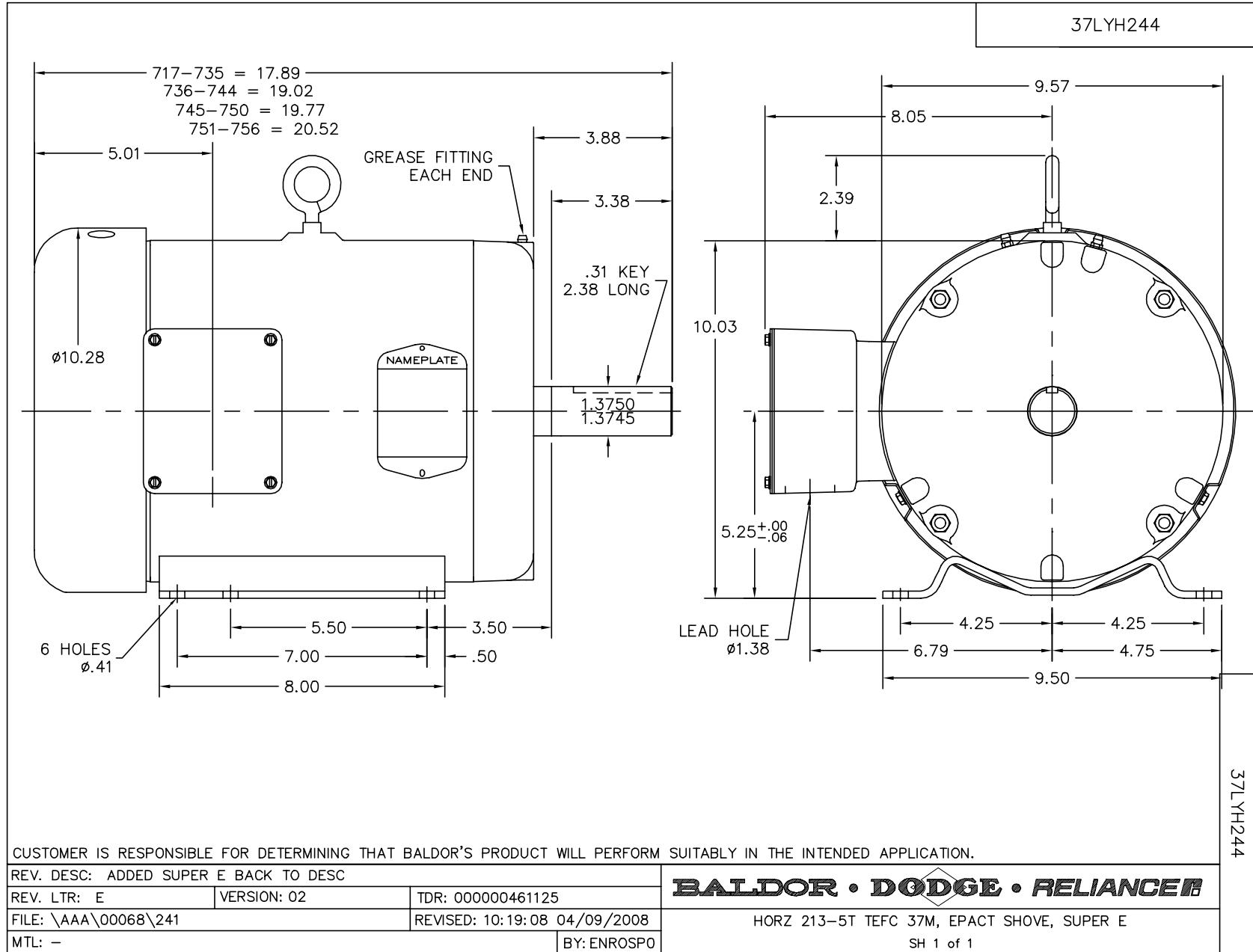

CD0005

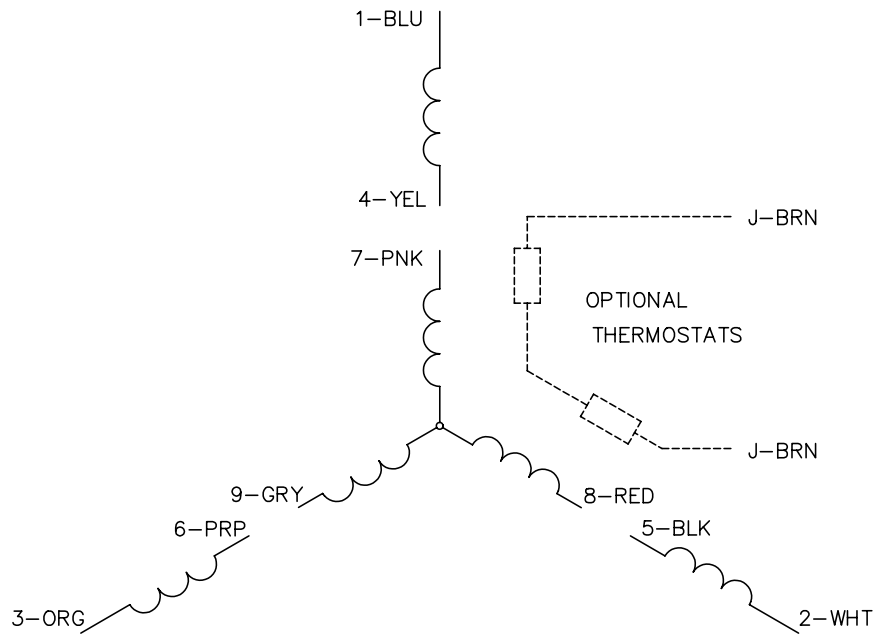

LOW VOLTAGE
(2Y)

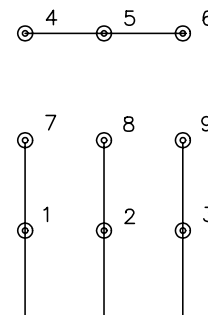

LINE

HIGH VOLTAGE
(1Y)

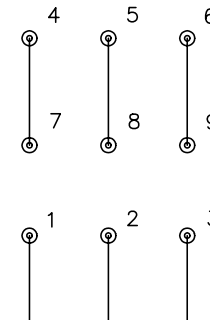

LINE

NOTES:

1. INTERCHANGE ANY TWO LINE LEADS TO REVERSE ROTATION.
2. OPTIONAL THERMOSTATS ARE PROVIDED WHEN SPECIFIED.
3. ACTUAL NUMBER OF INTERNAL PARALLEL CIRCUITS MAY BE A MULTIPLE OF THOSE SHOWN ABOVE.
4. LEAD COLORS ARE OPTIONAL. LEADS MUST ALWAYS BE NUMBERED AS SHOWN.

REV. DESC: REVISE TO SHOW OPTIONAL COLORS			
REV. LTR: E	BY: JLP	REVISED: 01/19/99 10:15	TDR: 0171435
900000		FILE: AAA00005140	MDL: -
		MTL: -	

BALDOR ELECTRIC Co.

3PH, DV, 9 LEADS

CD0005