

TYPE	OUTPUT		POLE	TIME RATING	VOLTAGE V	Hz	SYN. SPEED R. P. M
	HP.	kW.					
AFHH			2	CONT.			

TOTALLY ENCLOSED FAN-COOLED TYPE. SQUIRREL-CAGE ROTOR

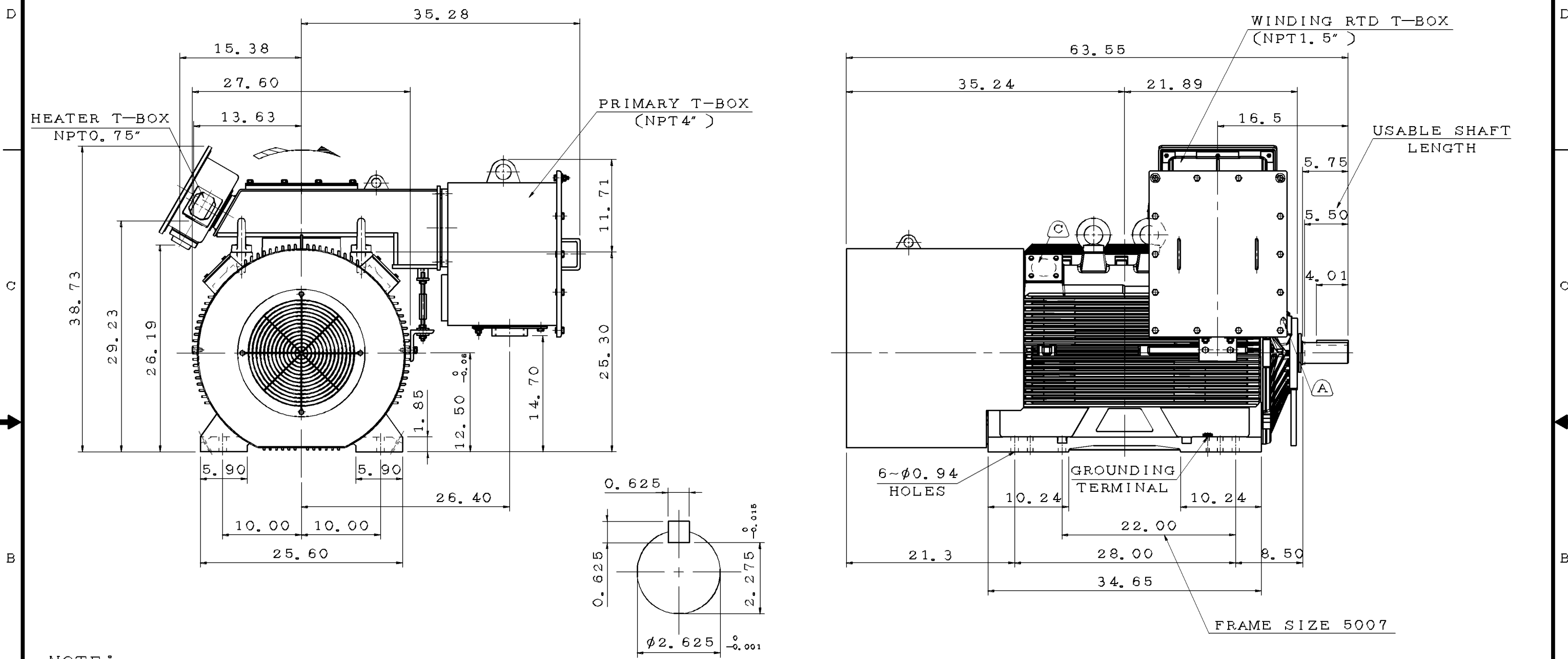

- NOTE:
1. DIMENSIONS IN inch
 2. FRAME NO. 5009A
 3. F CLASS INSULATION
 4. FOR DIRECT FLEXIBLE COUPLING
 5. ENCLOSURE: IP55
 6. BEARING SIZE: DRIVE-END 6315C3
OPP. DRIVE-END 6315C3
 7. WITH SPACE HEATER & WINDING RTD
 8. MOTOR APPROX. WEIGHT: 3900 lb

- (B) FOR BEARING RTD, END BRACKETS SHALL BE PRE-DRILLED AND PLUGGED.
(C) FOR AUXILIARY, FRAME SHALL BE PRE-DRILLED AND COVERD WITH STEEL PLATE.

DWN.	L. JHENG	APR.22.2019
CHKD.	H. WANG	APR.23.2019
APPD.	C. WANG	APR.23.2019

DATE	OUTLINE DIMENSIONS
	3-PHASE INDUCTION MOTOR
TECO Westinghouse	DWG NO. REV:01 5A040C159

ISSUED DEC. 20. 2018	PERFORMANCE DATA 3-PHASE HIGH EFFICIENCY INDUCTION MOTORS LOW VOLTAGE SQUIRREL CAGE	MODEL AFHH
REVISED NOV. 22. 2019		460V 60Hz

NEMA Premium	TEFC, 2P 460V 60HZ
-------------------------------	--------------------

OUTPUT HP	FULL LOAD RPM	FRAME NO. (EG)	EFFICIENCY			POWER FACTOR			CURRENT			TORQUE		Safe Stall Time(s)		ROTOR WR ² LB-FT ²	Max. Load WR ² LB-FT ²	APPROX. WEIGHT LBS
			FULL LOAD %	3/4 LOAD %	1/2 LOAD %	FULL LOAD %	3/4 LOAD %	1/2 LOAD %	Rated A	Starting %	Starting A	Starting %	Max. %	HOT SEC	COLD SEC			
350	3578	5009A	95.8	95.5	94.6	89.3	88.7	85.2	383	666	2550	120	220	23	31	53	284	3600
400	3579	5009A	96.9	95.6	94.8	89.7	89.1	85.7	431	673	2900	120	220	21	28	59	308	3700
450	3578	5009A	96.0	95.7	95.0	90.0	89.8	86.8	487	667	3250	120	220	21	27	65	355	3900
500	3577	5011A	96.1	95.7	95.1	90.4	90.3	87.6	539	672	3625	120	220	20	27	72	379	4300
600	3578	5011A	96.1	95.7	95.5	90.9	90.7	88.1	643	736	4730	120	220	18	24	88	450	4600
700	3580	5011A※	96.1	95.8	95.3	90.1	91.1	90.1	757	726	5500	120	220	15	23	92	497	4900
800	3585	5810A※	96.4	96.4	96.0	91.5	90.5	86.0	849	742	6300	120	230	19	25	187	568	6300

NOTE: 1 ACCORDING TO NEMA MG-1
 2P: RATINGS 500HP AND BELOW ARE PREMIUM EFFICIENCY.
 2 WITH "※" : COPPER ROTOR
 3 WITHOUT "※" : ALUMINUM ROTOR
 4 MULTIPLE MOUNTING DIMENSIONS FOR EACH FRAME NO.
 FRAME 5009: MOUNTING HOLE WITH 5009 & 5007
 FRAME 5011: MOUNTING HOLE WITH 5011, 5010 & 5009

APPD.	B.LIN	NOV. 22. 2019	TECO Electric & Machinery Co., Ltd.	DWG NO.
CHKD.	H.Y.WANG	NOV. 22. 2019		3A057M286E
DWN.	H.F.KUO	NOV. 22. 2019		REV.03 1/4

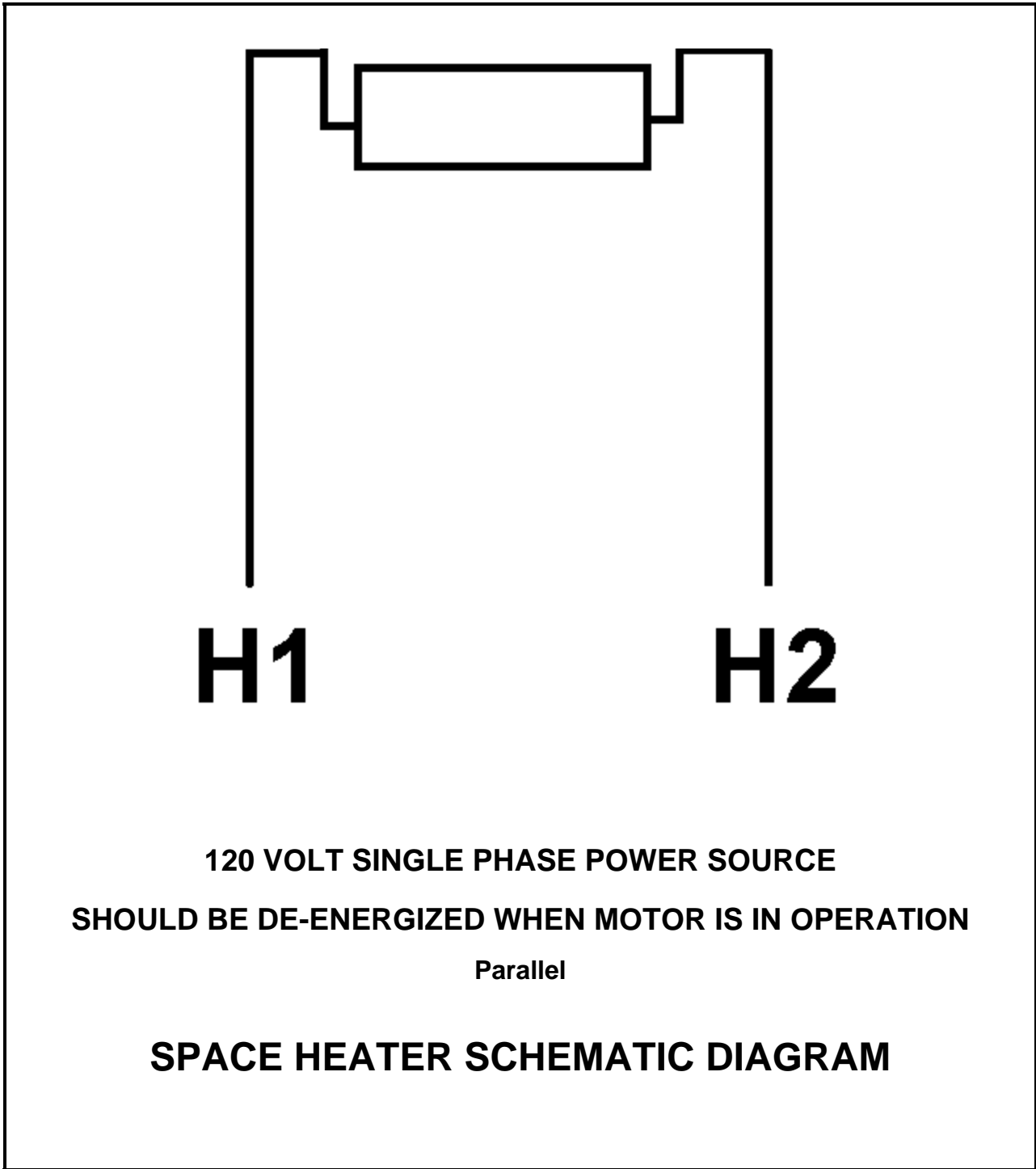

DATE:	CONNECTION DIAGRAM	MODEL:

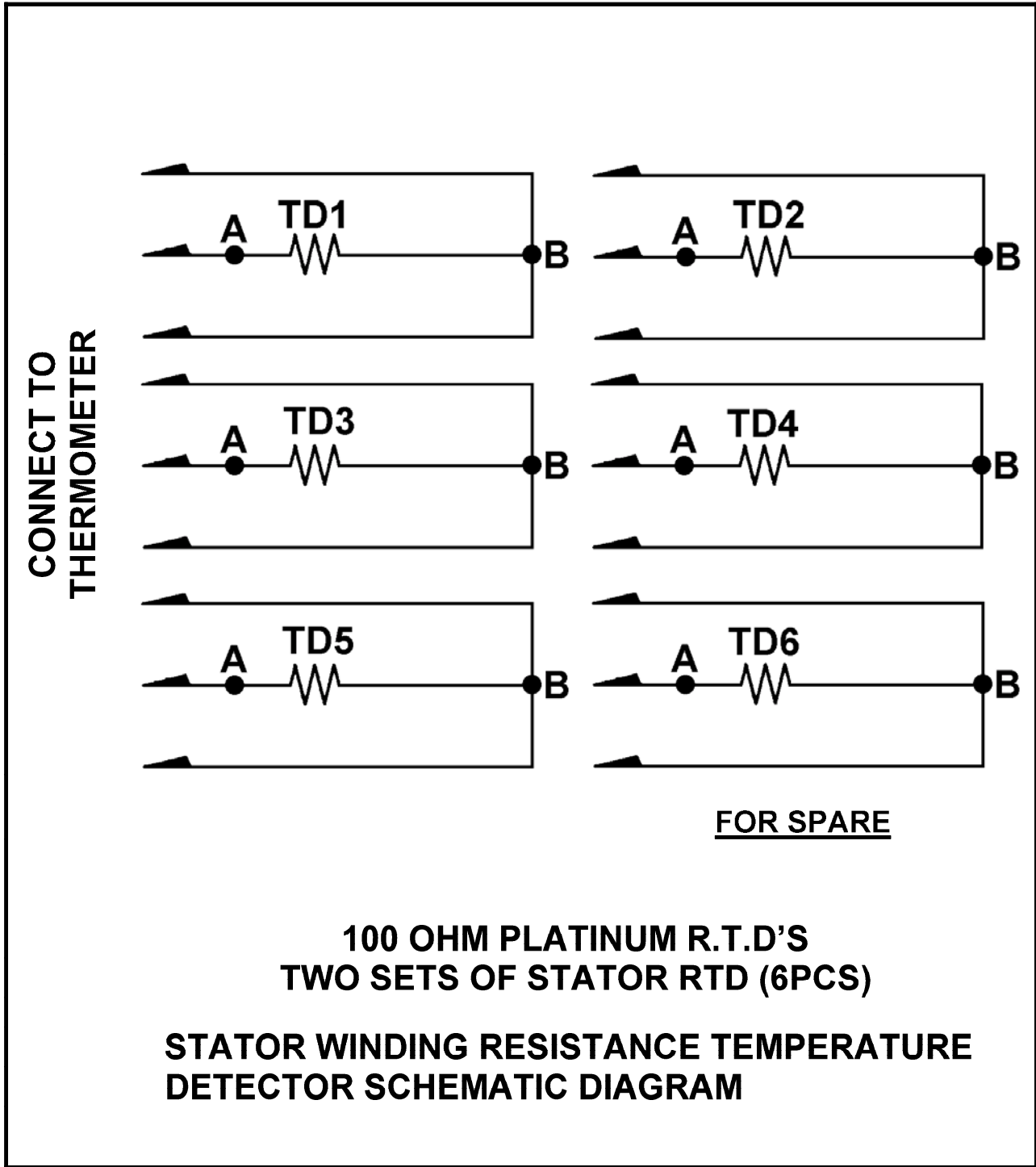

DWN.	98-09-08	TECO Westinghouse	DWG NO. REV:00
CHKD.	98-09-08		3A040D098
APPD.	98-09-08		

DATE:
April 8, 2020

CONNECTION DIAGRAM

SERIES:
AFHH

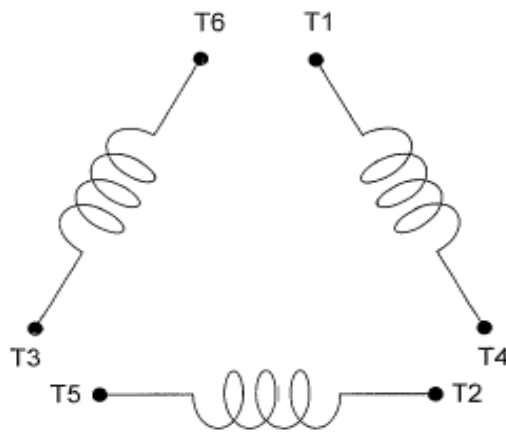

SCHEMATIC - Δ CONNECTION

ACROSS THE LINE CONNECTION

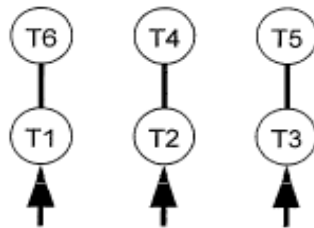

460 VOLT CONNECTION

WYE START-DELTA RUN CONNECTION

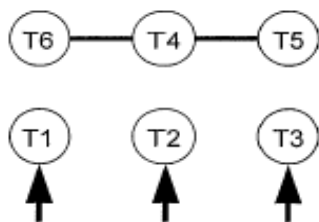

**LINE
460 VOLT START**

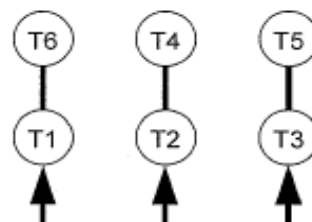

**LINE
460 VOLT RUN**