

DATE
MAY 28, 2009
CATALOG # GP0102

OUTLINE DIMENSIONS
3-PHASE INDUCTION MOTOR

MOTOR TYPE:
AEGH
FRAME NO. 215T

Pole	HP	kW	Hz	VOLT	Syn.Speed r/min(rpm)
2	10	7.5	60	230/460	3600

Ins	Rating	Dimension in	Approx Weight	Bearings
F	CONT.	inches	162 lbs.	DE: 6208ZZC3 NDE: 6206ZZC3

Totally Enclosed Fan-Cooled Type. Squirrel-Cage Rotor.

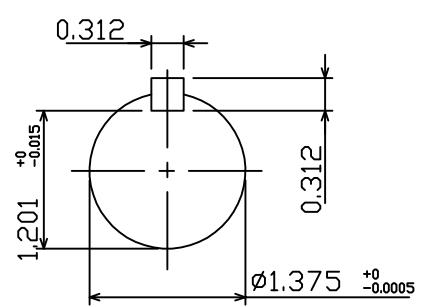
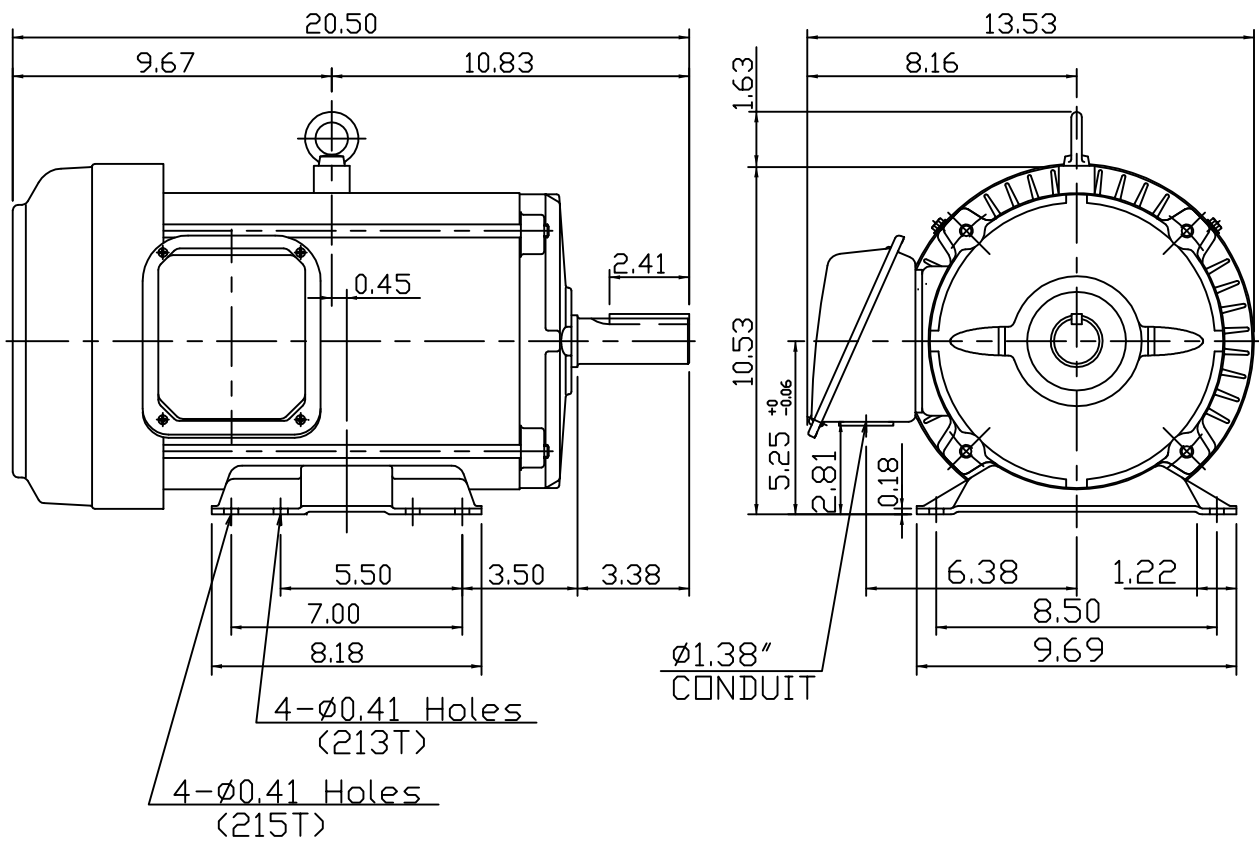

DWN.	J.H.LIANG	04-28-08
CHKD.	H.C.YAN	05-05-08
APPD.	M.C.TSAI	05-05-08



DWG NO.
31049R173010

TECO Westinghouse

ISSUED 12/27/13	PERFORMANCE DATA	ENCLOSURE TEFC
TYPE AEGH	3-PHASE INDUCTION MOTOR	CATALOG# GP0102

NAMEPLATE INFORMATION

OUTPUT		POLE	FRAME SIZE	VOLTAGE	HZ	RATED AMBIENT	INS. CLASS	NEMA DESIGN	TIME RATING	SERVICE FACTOR
HP	KW									
10	7.46	2	215T	230/460	60	40°C	F	B	CONT.	1.15

TYPICAL PERFORMANCE

FULL LOAD RPM	EFFICIENCY				POWER FACTOR			MAXIMUM POWER FACTOR CORRECTION
	FULL LOAD		3/4 LOAD %	1/2 LOAD %	F. L. %	3/4 LOAD %	1/2 LOAD %	
	MIN. %	NOM. %						
3525	89.5	91.0	91.0	91.0	86.0	82.0	74.0	2.37 KVAR

CURRENTS

NO LOAD			FULL LOAD			LOCKED ROTOR			NEMA KVA CODE LETTER
AT	AT	AT	AT	AT	AT	AT	AT	AT	
208 VOLT	230 VOLT	460 VOLT	208 VOLT	230 VOLT	460 VOLT	208 VOLT	230 VOLT	460 VOLT	
5.72	7.00	3.50	26.54	23.90	12.00	146.50	162.00	81.00	H

TORQUE

INERTIA

ACCEL TIME

FULL LOAD lb-ft	LOCKED ROTOR %FLT	PULL UP %FLT	BREAK DOWN %FLT	ROTOR WR ² lb-ft ²	NEMA LOAD WK ² lb-ft ²	MAX ALLOWABLE WK ² lb-ft ²	NEMA LOAD WK ² Sec	MAX ALLOWABLE WK ² Sec
14.90	220	205	275	0.443	11	33	3.86	11.29

SAFE STALL TIME IN SECONDS

ALLOWABLE STARTS PER HOUR

SOUND PRESSURE LEVEL @ 3 FT dB(A)

COLD	HOT	COLD	HOT	
17	12	2	1	70

APPROVED:	M. PRATER	DRAWING NO.	31057GP0102	REVISION 0
-----------	------------------	-------------	--------------------	-------------------

DATE:
May 28, 2009

CONNECTION DIAGRAM

GP0102

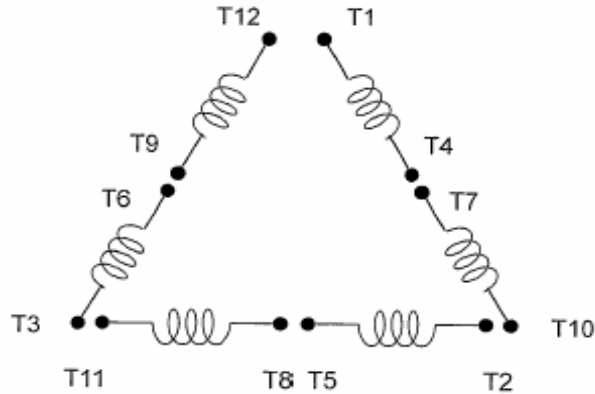

SCHEMATIC - Δ / Y CONNECTION

ACROSS THE LINE CONNECTION

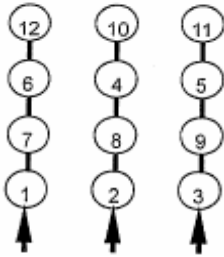

LINE
230 VOLT CONNECTION

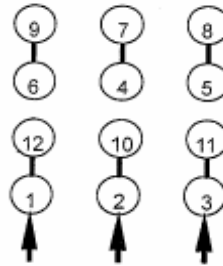

LINE
460 VOLT CONNECTION

WYE START-DELTA RUN CONNECTION

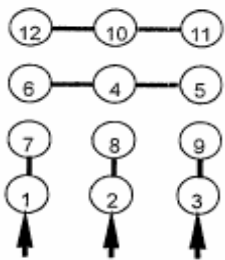

LINE
230 VOLT START

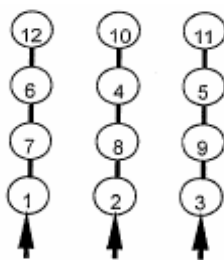

LINE
230 VOLT RUN

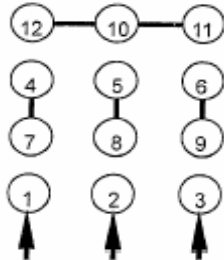

LINE
460 VOLT START

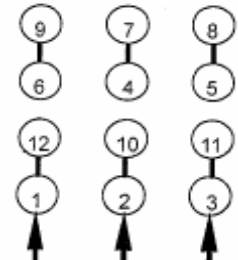

LINE
460 VOLT RUN



DWG NO.
DAC-1565-4