

PRODUCT INFORMATION PACKET

Model No: 284TSTFCD6003

Catalog No: GT1227A

General Purpose Motor, 25 HP, 3 Ph, 60 Hz, 230/460 V, 3600 RPM, 284TSC Frame, TEFC



Regal and are trademarks of Regal Rexnord Corporation or one of its affiliated companies.
©2022 Regal Rexnord Corporation, All Rights Reserved. MC017097E

Nameplate Specifications

Output HP	25 Hp	Output KW	18.7 kW
Frequency	60 Hz	Voltage	230/460 V
Current	60.0/30.0 A	Speed	3555 rpm
Service Factor	1.15	Phase	3
Efficiency	91.7 %	Power Factor	86
Duty	Continuous	Insulation Class	F
Design Code	B	KVA Code	G
Frame	284TSC	Enclosure	Totally Enclosed Fan Cooled
Thermal Protection	No Protection	Ambient Temperature	40 °C
Drive End Bearing Size	6311	Opp Drive End Bearing Size	6211
UL	Listed	CSA	Y
CE	Y	IP Code	55
Hazardous Location	DIVISION 2 T2B	Number of Speeds	1

Technical Specifications

Electrical Type	Squirrel Cage Inverter Rated	Starting Method	Part Wdg Start Low Volt Only & Wye Start Delta Run Or Inverter
Poles	2	Rotation	Reversible
Resistance Main	.395 Ohms	Mounting	Rigid Base
Motor Orientation	Horizontal	Drive End Bearing	Ball
Opp Drive End Bearing	Ball	Frame Material	Cast Iron
Shaft Type	TS	Overall Length	25.28 in
Frame Length	11.41 in	Shaft Diameter	1.625 in
Shaft Extension	3.25 in	Assembly/Box Mounting	F1/F2 CAPABLE
Inverter Load	CONSTANT 2:1/VARIABLE 10:1		
Outline Drawing	SS620706-100	Connection Drawing	EE7308AA

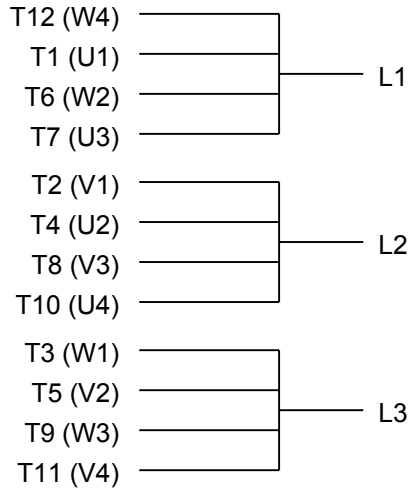

LOW VOLTAGE

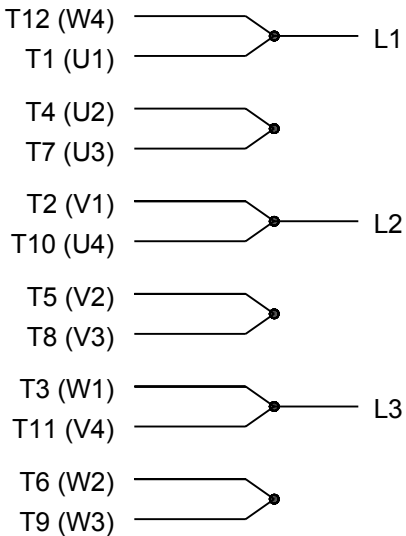

HIGH VOLTAGE

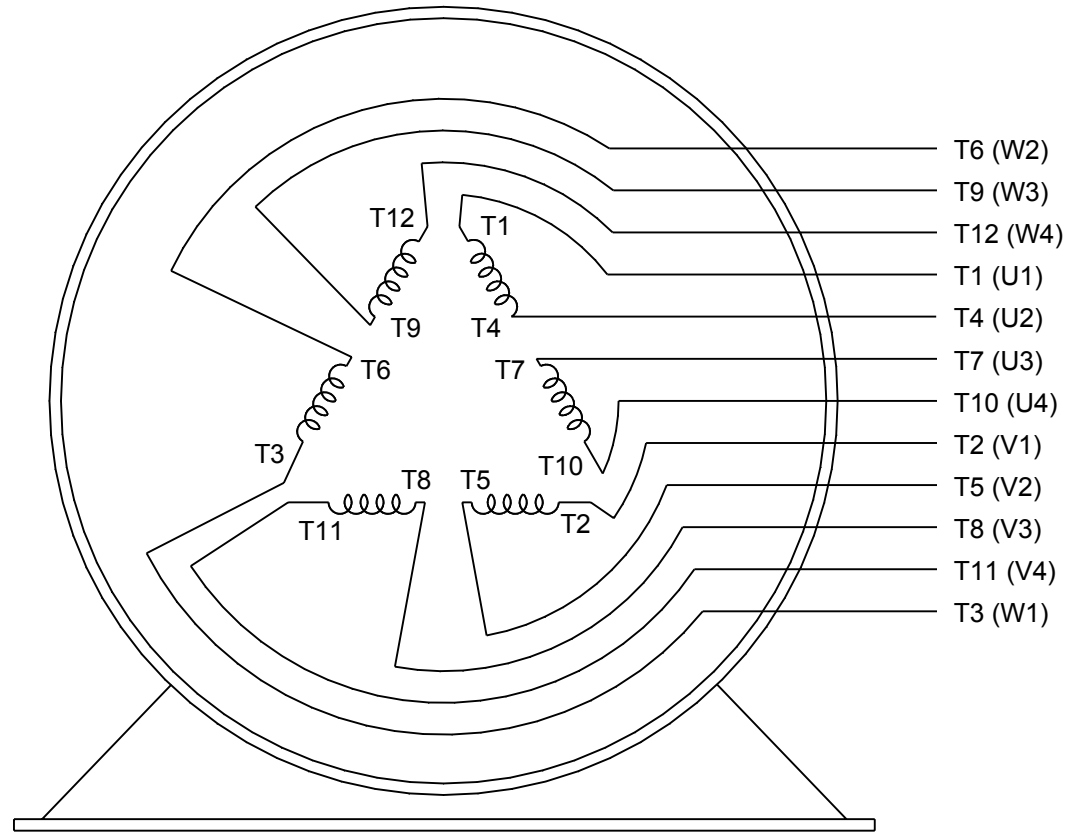

VIEW OF TERMINAL END

DRAWING REVISION K	REVISION BY AJW	DATE 07-17-2015
ECO ECO-0081632	APPROVED BY T. VUE	DATE 07-17-2015
ECO DESCRIPTION REV'D IEC MARKINGS PER IEC 60034-8		
<small>COPYRIGHT REGAL BELOIT AMERICA, INC. ALL RIGHTS RESERVED. PROPRIETARY AND CONFIDENTIAL INFORMATION - THIS DOCUMENT IS THE PROPERTY OF REGAL BELOIT AMERICA, INC. ("OWNER") AND CONTAINS OWNER'S PROPRIETARY INFORMATION. ANY PERSON, CORPORATION OR OTHER FIRM RECEIVING IT IS DEEMED, BY RECEIVING IT, TO AGREE THAT IT, AND/OR ANY PART OF IT, SHALL NOT BE DISCLOSED TO ANY PERSON, CORPORATION OR OTHER ENTITY, DUPLICATED, AND/OR USED, EXCEPT AS EXPRESSLY APPROVED IN WRITING IN ADVANCE BY OWNER. THIS DOCUMENT SHALL BE RETURNED TO OWNER UPON REQUEST. IT MAY BE SUBJECT TO CERTAIN RESTRICTIONS UNDER APPLICABLE EXPORT CONTROL LAWS AND REGULATIONS.</small>		

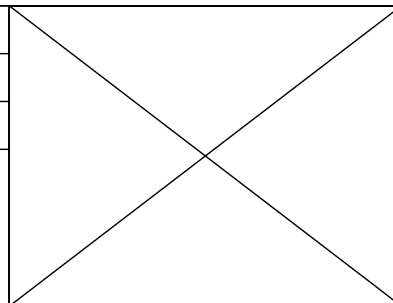

DRAWN BY LZ	Regal Beloit America, Inc.	
DATE 01-12-1994		
APPROVED BY GK	DESCRIPTION CONN DIAGRAM-EXTERNAL 3Ø-2/1 DELTA-12 LEADS	
DATE 01-14-1994		
REFERENCE	MATERIAL	PROCESS/FINISH
THIRD ANGLE PROJECTION	SIZE A	DRAWING NUMBER EE7308AA
		SHEET 1 OF 1



P.O. BOX 8003
WAUSAU, WI 54401-8003
PH. 715-675-3311

DATA VOLTS: 460

CERTIFICATION DATA SHEET

CUSTOMER: _____ CUSTOMER P.O. #: _____
 ORDER #: _____ REFERENCE MODEL #: 284TSTFCD6003
 CONN. DIAGRAM: A-EE7308AA CAT #: GT1227A
 OUTLINE: B-SS620701 CUSTOMER PART #: _____
 WINDING: HE31802004 NONE 2 MOUNTING: F1/F2 CAPABLE
 SPEED: _____

TYPICAL MOTOR PERFORMANCE DATA

HP	KW	SYNC RPM	FL RPM	FRAME	ENCLOSURE	TYPE	KVA CODE	DESIGN
25	18.7	3600	3555	284TSC	TEFC	TFC	G	B

PH	HZ	VOLTS	AMPS	START TYPE	DUTY	INSL	S.F.	AMB	ELEV.
3	60/50	230/460#190/380	60/30&58/29	LINE OR INVERTER	CONT	F	1.15	40	3300

F.L. EFF	91.7	3/4 LD EFF	91.7	1/2 LD EFF	91.0	GTD EFF	91.0	ELECT. TYPE	SQ CAGE INV RATED
F.L. PF	86.0	3/4 LD PF	82.0	1/2 LD PF	73.5				

F.L. TORQUE	LR AMPS @ 460 V	L.R. TORQUE	B.D. TORQUE	F.L. RISE (°C)
37.0 LB-FT	181	65.0 LB-FT 176%	94.0 LB-FT 254%	55

@ 3 FT.	POWER	ROTOR WK²	MAX. LOAD WK²	SAFE STALL TIME	STARTS/HOUR	MOTOR WGT
72 dBA	81 dBA	2.90 LB-FT²	32 LB-FT²	20 SEC.	2	460 LB.

*** SUPPLEMENTAL INFORMATION ***

DE BRACKET TYPE	ODE BRACKET TYPE	MOUNT TYPE	MOTOR ORIENTATION	SEVERE DUTY	HAZARDOUS LOCATION	DRIP COVER	SCREENS	PAINT
C-FACE	STANDARD	RIGID	HORIZONTAL	NO	NONE	NO	NONE	BLUE (ENAMEL)

BEARINGS		GREASE	SHAFT TYPE	SPECIAL DE	SPECIAL ODE	SHAFT MATERIAL	FRAME MATERIAL
DE	ODE	POLYREX EM	TS	NONE	NONE	1045 HOT ROLLED (C-204)	CAST IRON
BALL	BALL						
6211	6211						

THERMOSTATS	PROTECTORS	WDG RTD's	BRG RTD's	THERMISTORS	CONTROL	SPACE HEATERS
NONE	NOT	NONE	NONE	NONE	FALSE	NA

R1 (ohms/ph)	R2 (ohms/ph)	X1 (ohms/ph)	X2 (ohms/ph)	Xm (ohms/ph)	VIBRATION (in/sec)	FLOAT
0.261	0.113	0.826	0.864	24.381	0.150	ODE

* N O T E S *	INVERTER TORQUE: CONSTANT 10:1	
	INV. HP SPEED RANGE: NONE	
	ENCODER: NONE	
	NONE	
	NONE NONE PPR	

PREPARED BY: FAREEDA DUDEKULA	BRAKE: NONE
DATE: 5/3/2018	NONE NONE
	FT-LB: NA
	VOLTAGE: NONE HZ:
FORM: 3531 REV_4 2/27/06	UL: V-INS, CONST UL REC

Data Sheet

284TSTFCD6003

Date: 5/3/2018
 Customer: _____
 Attention: _____
 Submitted by: FAREEDA DUDEKULA



Submittal

Data @ 460 V

Motor Load Data

Load	0%	25%	50%	75%	100%	115%	125%	LR
Current (Amps)	11.1	13.2	17.7	23.4	30.0	34.1	37.0	181
Torque (ft-lb)	0.00	9.2	18.5	27.5	37.0	42.5	46.3	65.0
RPM	3600	3588	3578	3565	3555	3,546	3540	0
Efficiency (%)		86.5	91.0	91.7	91.7	91.4	91.0	
P.F. (%)	8.0	52.0	73.5	82.0	86.0	87.0	87.5	35.0

Motor Speed Data

	LR	Pull-Up	BD	Rated	Idle
Speed (RPM)	0	1800	3330	3555	3600
Current (Amps)	181	166	105	30.0	11.1
Torque (ft-lb)	65.0	56.0	94.0	37.0	0.00

Information Block

HP	25.0			
Sync. RPM	3600			
Frame	284182TFC6080			
Enclosure	TEFC			
Construction	TFC			
Voltage	230/460#190/380 V			
Frequency	60 Hz			
Design	B			
LR Code letter	G			
Service Factor	1.15			
Temp Rise @ FL	55 °C			
Duty	CONT			
Ambient	40 °C			
Elevation	1,000 feet			
Rotor/Shaft wk ²	2.90 Lb-Ft ²			
Ref Wdg	HE31802004 NONE			
Sound Pressure @ 1M	72 dBA			
VFD Rating	CONSTANT 10:1			
Outline Dwg	B-SS620701			
Conn. Diag	A-EE7308AA			
Additional Specifications:				
0				
0				
EQUIV CKT (OHMS / PHASE)				
R1	R2	X1	X2	Xm
0.2610	0.1130	0.8260	0.8640	24.3810

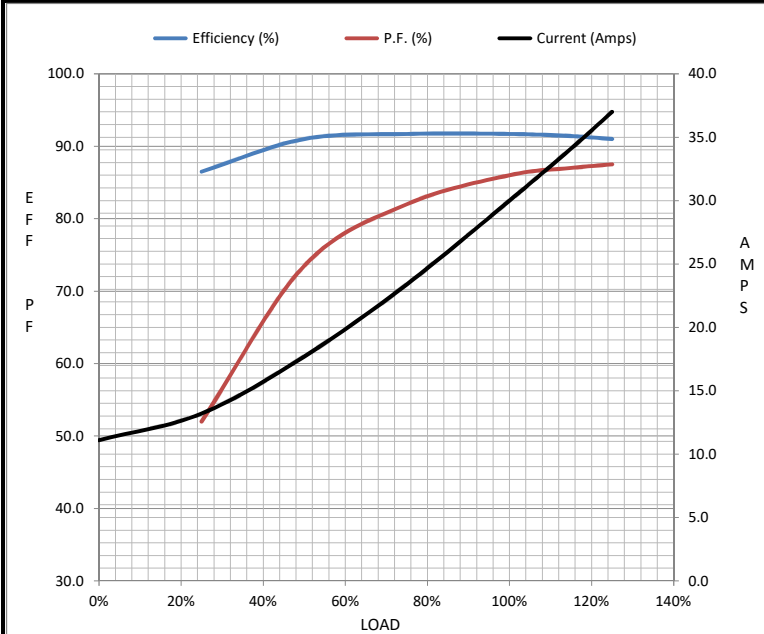

Speed -Torque Curve

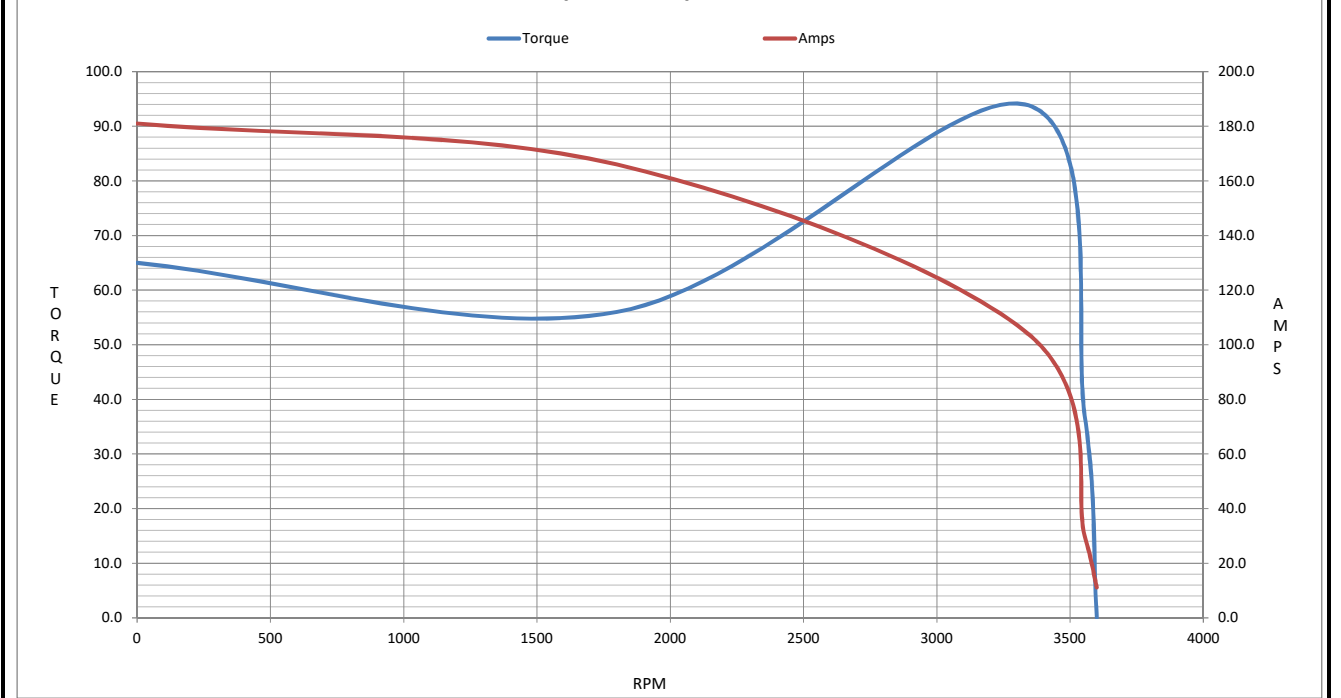

EC Declaration of Conformity

The undersigned representing
the manufacturer:

Regal Beloit America
100 East Randolph St.
Wausau, WI 54401

and the authorized representative
established within the Community:

Marathon Electric UK
6F Thistleton Road Ind. Estate
Market Overton
Oakham, Rutland LE15 7PP UK

are committed to providing customers with products that comply with applicable regulations and international protocols to which they are subject, including the requirements of the European Parliament Directive on the Harmonization of the laws relating to electrical equipment designed for use within certain voltage limits (2014/35/EU).

Regal Beloit America declares that the following product(s), to which this declaration relates, are in conformity with the relevant sections of the EC standards listed below.

This statement supersedes any statements previously issued pertaining to the product(s) listed below and is subject to change without notice.

Model No : 284TSTFCD6003

(Model No. may contain prefix and/or suffix characters)

Catalog No : GT1227A

Rework No : N/A

Directives :

Low Voltage Directive 2014/35/EU

Harmonized Standards Used :

EN 60034-1: 2010 (IEC 60034-1: 2010)

EN 60034-5: 2001/A1:2007 (IEC 60034-5: 2000/A1:2006)

Authorized Representative:

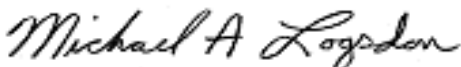

Michael A. Logsdon
Vice President, Technology

Authorized Representative in the Community:



Julian Clark
Marketing Engineer

Created on 09/01/2022

CE 22