

NIDEC MOTOR CORPORATION

8050 WEST FLORISSANT AVE.
ST. LOUIS, MO 63136



DATE: 4/20/2022

P.O. NO.: BF32
Order/Line NO.: 17156 MN 100

TO:

Model Number: BF32
Catalog Number: HO20V2BLF
VHS Weather Protected
CONF,MOTOR,VHS WPI

REVISIONS:

**ALL DOCUMENTS HEREIN ARE CONSIDERED CERTIFIED BY NIDEC MOTOR CORPORATION.
THANK YOU FOR YOUR ORDER AND THE OPPORTUNITY TO SERVE YOU.**

Features:

Horsepower 00020.00~00000.00 ~ KW: 14.92
Enclosure WPI
Poles 04~00 ~ RPM: 1800~0
Frame Size 256~TPH
Phase/Frequency/Voltage.. 3~060~230/460 ~ Random Wound
Service Factor 1.15
Insulation Class Class "F" ~ Insulife 2000
Altitude In Feet (Max) .. 3300 Ft.(1000 M) ~ +40 C
Efficiency Class Energy Efficient
Application Unknown
Customer Part Number
12" Base ~ Coupling Size: 1" Bore, 1/4" Key
Non-Reverse Ratchet ~ Steady Bushing Not Requested
Pricebook Thrust Value (lbs).. 3200
Customer Down Thrust (lbs) ... 3200
Customer Shutoff Thrust (lbs).
Up Thrust (lbs): ~
Inverter Duty Rating:
Load Type (Base Hz & Below) .. Variable Torque
Speed Range (Base Hz & Below). 10:1
Temperature Rise (Sine Wave): "F" Rise @ SF (Resist)
Starting Method PWS (Dual Volt-Low Volt Only)
Duty Cycle Continuous Duty
Load Inertia (lb-ft²): NEMA ~ NEMA Inertia: 98.70 ~ 1.00
Number Of Starts Per Hour: NEMA
Motor Type Code AUI
Rotor Inertia (LB-FT²) 2.45 LB-FT²
Qty. of Bearings PE (Shaft) 1
Qty. of Bearings SE (OPP) 1
Bearing Number PE (Shaft) 7310 BEP
Bearing Number SE (OPP) 6210-2Z-J/C3

Nidec trademarks followed by the ® symbol are registered with the U.S. Patent and Trademark Office.

NIDEC MOTOR CORPORATION

8050 WEST FLORISSANT AVE.
ST. LOUIS, MO 63136



DATE: 4/20/2022

P.O. NO.: BF32
Order/Line NO.: 17156 MN 100

TO:

Model Number: BF32
Catalog Number: HO20V2BLF
VHS Weather Protected
CONF,MOTOR,VHS WPI

REVISIONS:

**ALL DOCUMENTS HEREIN ARE CONSIDERED CERTIFIED BY NIDEC MOTOR CORPORATION.
THANK YOU FOR YOUR ORDER AND THE OPPORTUNITY TO SERVE YOU.**

Accessories:

Counter CW Rotation FODE
115 Volt Space Heaters
VFD Duty
Standard Leadtime: REFER TO OFFICE
Est. Weight (lbs ea): 280 ~ F.O.B.: St. Louis, MO
Horsepower 00020.00~00000.00 ~ KW: 14.92
Enclosure WPI
Poles 04~00 ~ RPM: 1800~0
Frame Size 256~TPH
Phase/Frequency/Voltage.. 3~060~230/460 ~ Random Wound
Service Factor 1.15
Insulation Class Class "F" ~ Insulife 2000
Altitude In Feet (Max) .. 3300 Ft.(1000 M) ~ +40 C
Efficiency Class Energy Efficient
Application Unknown
Customer Part Number
12" Base ~ Coupling Size: 1" Bore, 1/4" Key
Non-Reverse Ratchet ~ Steady Bushing Not Requested
Pricebook Thrust Value (lbs).. 3300
Customer Down Thrust (lbs) ... 3200
Customer Shutoff Thrust (lbs).
Up Thrust (lbs): ~
Inverter Duty Rating:
Load Type (Base Hz & Below) .. Variable Torque
Speed Range (Base Hz & Below). 10:1
Temperature Rise (Sine Wave): "F" Rise @ SF (Resist)
Starting Method PWS (Dual Volt-Low Volt Only)
Duty Cycle Continuous Duty
Load Inertia (lb-ft²): NEMA ~ NEMA Inertia: 98.70 ~ 1.00
Number Of Starts Per Hour: NEMA
Motor Type Code AUI
Counter CW Rotation FODE
115 Volt Space Heaters
VFD Duty
Standard Leadtime: REFER TO OFFICE
Est. Weight (lbs ea): 300 ~ F.O.B.: St. Louis, MO

USE THE DATA PROVIDED BELOW TO SELECT THE APPROPRIATE DIMENSION PRINT

| | |
|----------------------|---------|
| Horsepower | 20 |
| Pole(s) | 04 |
| Voltage(s) | 460-230 |
| Frame Size | 256TPH |
| Outlet Box AF | 2.03 |
| Outlet Box AA | 1.25 |

EFFECTIVE:
07-JUL-16

SUPERSEDES:
25-APR-11

DIMENSION PRINT
WEATHER PROTECTED TYPE I
FRAME: 250TP, TPA, TPH
BASIC TYPE: AU

PRINT:
09-2289

SHEET:
1 OF 1

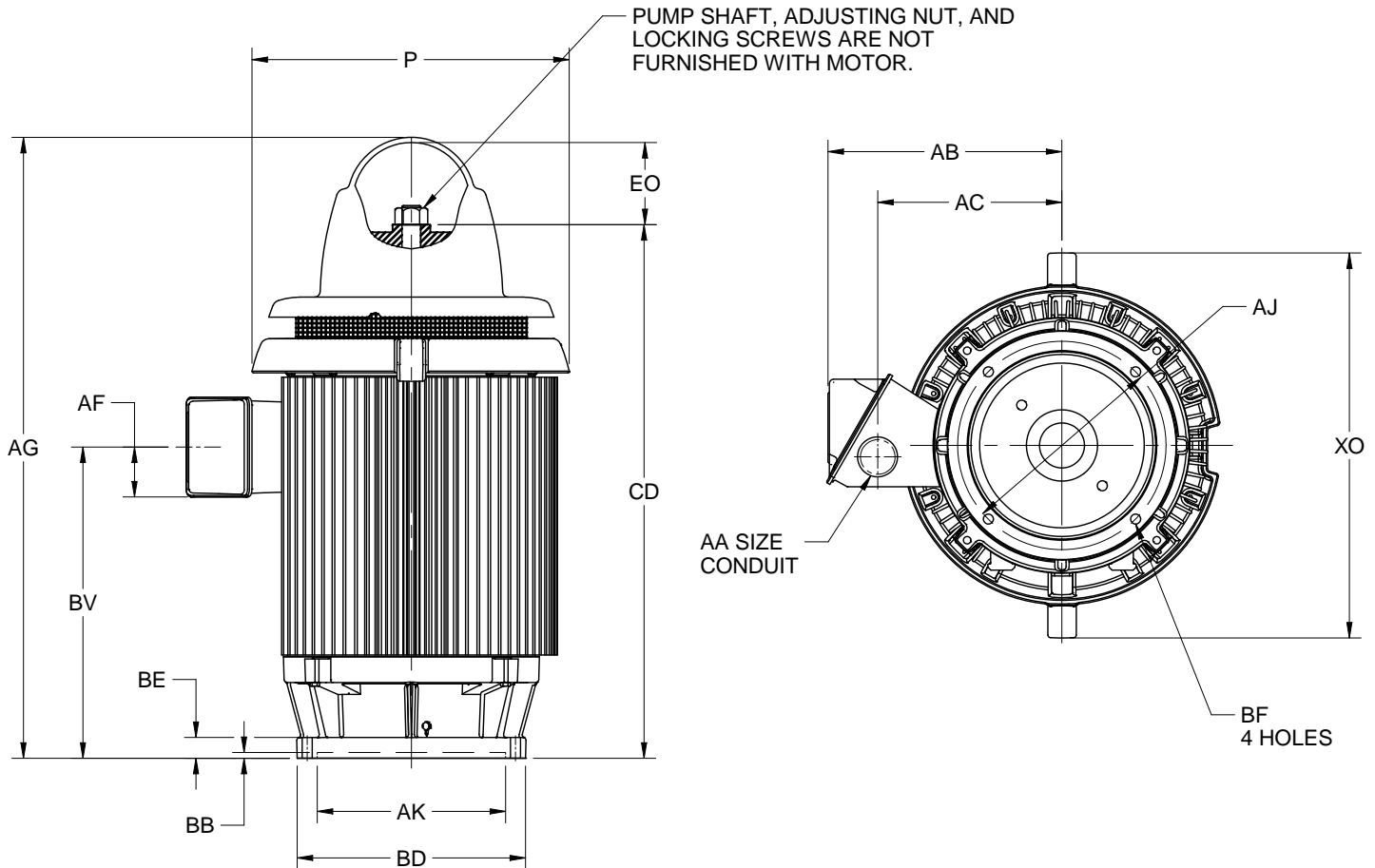

ALL DIMENSIONS ARE IN INCHES AND MILLIMETERS

| UNITS | P ² | AA | AB | AC | AF | AG ⁵ | BB MIN | BE | BV | CD ⁵ | EO | XO |
|-------|----------------|------|-------|------|------|-----------------|-----------|-----|-------|-----------------|------|-------|
| IN | 14.00 | 1.25 | 10.25 | 7.88 | 2.03 | 26.75 | .25 | .94 | 11.50 | 23.38 | 3.25 | 16.88 |
| MM | 356 | | 260 | 200 | 52 | 679 | 6 | 24 | 292 | 594 | 83 | 429 |

| FRAME | UNITS | AJ | AK | BD MAX | BF |
|-------------|-------|--------|--------|-----------|-----|
| 254, 256TP | IN | 9.125 | 8.250 | 10.00 | .44 |
| | MM | 231.78 | 209.55 | 254 | 11 |
| 254, 256TPA | IN | 14.750 | 13.500 | 16.50 | .69 |
| | MM | 374.65 | 342.90 | 419 | 18 |
| 254, 256TPH | IN | 9.125 | 8.250 | 12.00 | .44 |
| | MM | 231.78 | 209.55 | 305 | 11 |

1. ALL ROUGH DIMENSIONS MAY VARY BY .25" DUE TO CASTING AND/OR FABRICATION VARIATIONS.
2. LARGEST MOTOR WIDTH.
3. TOLERANCES SHOWN ARE IN INCHES ONLY.

4. CONDUIT OPENINGS MAY BE LOCATED IN STEPS OF 180 DEGREES REGARDLESS OF LOCATION. STANDARD AS SHOWN.
5. DIMENSIONS SHOWN ARE FOR ALL RATINGS EXCEPT 20 HP, 4 POLE, TYPE AUE AND AUJ. FOR THIS RATING THE DIMENSIONS ARE: AG=28.13 (715 MM)
CD=24.75 (629 MM)

09-2289/E

Nidec Motor Corporation
St. Louis, Missouri

INFORMATION DISCLOSED ON THIS DOCUMENT IS CONSIDERED PROPRIETARY AND SHALL NOT BE REPRODUCED OR DISCLOSED WITHOUT WRITTEN CONSENT OF NIDEC MOTOR CORPORATION



ISSUED BY
R. MARTINEZ
APPROVED BY
R. ALVAREZ

IHP_DP_NMCA (MAR-2011) SOLIDEDGE

NAMEPLATE DATA

| | |
|--|--|
| CATALOG NUMBER: <input style="width: 150px;" type="text" value="HO20V2BLF"/> | NAMEPLATE PART #: <input style="width: 150px;" type="text" value="422707-005"/> |
| MODEL <input style="width: 50px;" type="text" value="BF32"/> <input style="width: 50px;" type="text" value="FR"/> <input style="width: 50px;" type="text" value="256TPH"/> | TYPE <input style="width: 50px;" type="text" value="AUI"/> ENCL <input style="width: 50px;" type="text" value="WPI"/> |
| SHAFT END BRG <input style="width: 150px;" type="text" value="7310 BEP - QTY 1"/> | OPP END BRG <input style="width: 150px;" type="text" value="6210-2Z-J/C3 - QTY 1"/> |
| PH <input style="width: 50px;" type="text" value="3"/> MAX AMB <input style="width: 50px;" type="text" value="40 C"/> | ID# <input style="width: 150px;" type="text"/> |
| INSUL CLASS <input style="width: 50px;" type="text" value="F"/> Asm. Pos. <input style="width: 150px;" type="text"/> | DUTY <input style="width: 150px;" type="text" value="CONT"/> |
| HP <input style="width: 50px;" type="text" value="20"/> <input style="width: 50px;" type="text"/> RPM <input style="width: 50px;" type="text" value="1770"/> <input style="width: 50px;" type="text"/> | HP <input style="width: 50px;" type="text"/> <input style="width: 50px;" type="text"/> RPM <input style="width: 50px;" type="text"/> <input style="width: 50px;" type="text"/> |
| VOLTS <input style="width: 50px;" type="text" value="460"/> <input style="width: 50px;" type="text" value="230"/> <input style="width: 50px;" type="text"/> | VOLTS <input style="width: 50px;" type="text"/> <input style="width: 50px;" type="text"/> <input style="width: 50px;" type="text"/> |
| FL AMPS <input style="width: 50px;" type="text" value="23.7"/> <input style="width: 50px;" type="text" value="47.0"/> <input style="width: 50px;" type="text"/> | FL AMPS <input style="width: 50px;" type="text"/> <input style="width: 50px;" type="text"/> <input style="width: 50px;" type="text"/> |
| SF AMPS <input style="width: 50px;" type="text" value="27.5"/> <input style="width: 50px;" type="text" value="55.0"/> | SF AMPS <input style="width: 50px;" type="text"/> <input style="width: 50px;" type="text"/> |
| SF <input style="width: 50px;" type="text" value="1.15"/> DESIGN <input style="width: 50px;" type="text" value="B"/> CODE <input style="width: 50px;" type="text" value="G"/> | SF <input style="width: 50px;" type="text"/> DESIGN <input style="width: 50px;" type="text"/> CODE <input style="width: 50px;" type="text"/> |
| NEMA NOM EFFICIENCY <input style="width: 50px;" type="text" value="92.4"/> NOM PF <input style="width: 50px;" type="text" value="85.4"/> KiloWatt <input style="width: 50px;" type="text" value="14.9"/> | NEMA NOM EFFICIENCY <input style="width: 50px;" type="text"/> NOM PF <input style="width: 50px;" type="text"/> |
| GUARANTEED EFFICIENCY <input style="width: 50px;" type="text" value="91.0"/> MAX KVAR <input style="width: 50px;" type="text"/> HZ <input style="width: 50px;" type="text" value="60"/> | GUARANTEED EFFICIENCY <input style="width: 50px;" type="text"/> MAX KVAR <input style="width: 50px;" type="text"/> HZ <input style="width: 50px;" type="text"/> |

HAZARDOUS LOCATION DATA (IF APPLICABLE):

| | | |
|--|---|---|
| DIVISION <input style="width: 100px;" type="text"/> | CLASS I <input style="width: 100px;" type="text"/> | GROUP I <input style="width: 100px;" type="text"/> |
| TEMP CODE <input style="width: 100px;" type="text"/> | CLASS II <input style="width: 100px;" type="text"/> | GROUP II <input style="width: 100px;" type="text"/> |

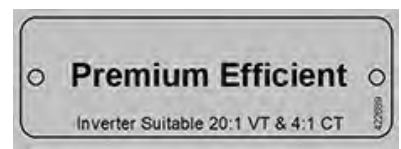

VFD DATA (IF APPLICABLE):

| | |
|---|--|
| VOLTS <input style="width: 50px;" type="text" value="460"/> <input style="width: 50px;" type="text" value="230"/> | AMPS <input style="width: 50px;" type="text" value="24.9"/> <input style="width: 50px;" type="text" value="49.4"/> |
| TORQUE 1 <input style="width: 100px;" type="text" value="59.4LB-FT"/> | TORQUE 2 <input style="width: 100px;" type="text"/> |
| VFD LOAD TYPE 1 <input style="width: 100px;" type="text" value="VT/PWM"/> | VFD LOAD TYPE 2 <input style="width: 100px;" type="text"/> |
| VFD HERTZ RANGE 1 <input style="width: 100px;" type="text" value="6-60"/> | VFD HERTZ RANGE 2 <input style="width: 100px;" type="text"/> |
| VFD SPEED RANGE 1 <input style="width: 100px;" type="text" value="180-1800"/> | VFD SPEED RANGE 2 <input style="width: 100px;" type="text"/> |
| SERVICE FACTOR <input style="width: 100px;" type="text" value="1.00"/> | FL SLIP <input style="width: 100px;" type="text"/> |
| NO. POLES <input style="width: 100px;" type="text"/> | MAGNETIZING AMPS <input style="width: 100px;" type="text"/> |
| VECTOR MAX RPM <input style="width: 100px;" type="text"/> | Encoder PPR <input style="width: 100px;" type="text"/> |
| Radians / Seconds <input style="width: 100px;" type="text"/> | Encoder Volts <input style="width: 100px;" type="text"/> |

TEAO DATA (IF APPLICABLE):

| | | | |
|--|--|--|--|
| HP (AIR OVER) <input style="width: 50px;" type="text"/> | HP (AIR OVER M/S) <input style="width: 50px;" type="text"/> | RPM (AIR OVER) <input style="width: 50px;" type="text"/> | RPM (AIR OVER M/S) <input style="width: 50px;" type="text"/> |
| FPM AIR VELOCITY <input style="width: 50px;" type="text"/> | FPM AIR VELOCITY M/S <input style="width: 50px;" type="text"/> | FPM AIR VELOCITY SEC <input style="width: 50px;" type="text"/> | |

ADDITIONAL NAMEPLATE DATA:

| | | | |
|---------------------------|-------------|---------------------------|---------------|
| Decal / Plate | WD=344133 | Customer PN | |
| Notes | | Non Rev Ratchet | NRR |
| Max Temp Rise | | OPP/Upper Oil Cap | GREASE |
| Thermal (WDG) | | SHAFT/Lower Oil Cap | GREASE |
| Altitude | | Usable At | |
| Regulatory Notes | | Regulatory Compliance | |
| COS | | Marine Duty | |
| Balance | 0.08 IN/SEC | Arctic Duty | |
| 3/4 Load Eff. | 93.3 | Inrush Limit | |
| Motor Weight (LBS) | 300 | Direction of Rotation | |
| Sound Level | | Special Note 1 | |
| Vertical Thrust (LBS) | 3300 | Special Note 2 | |
| Thrust Percentage | 100% HT | Special Note 3 | |
| Bearing Life | | Special Note 4 | |
| Starting Method | | Special Note 5 | |
| Number of Starts | | Special Note 6 | |
| 200/208V 60Hz Max Amps | | SH Max. Temp. | |
| 190V 50 hz Max Amps | | SH Voltage | SH VOLTS=115V |
| 380V 50 Hz Max Amps | | SH Watts | SH WATTS= 48W |
| NEMA Inertia | | Load Inertia | |
| Sumpheater Voltage | | Sumpheater Wattage | |
| Special Accessory Note 1 | | Special Accessory Note 16 | |
| Special Accessory Note 2 | | Special Accessory Note 17 | |
| Special Accessory Note 3 | | Special Accessory Note 18 | |
| Special Accessory Note 4 | | Special Accessory Note 19 | |
| Special Accessory Note 5 | | Special Accessory Note 20 | |
| Special Accessory Note 6 | | Special Accessory Note 21 | |
| Special Accessory Note 7 | | Special Accessory Note 22 | |
| Special Accessory Note 8 | | Special Accessory Note 23 | |
| Special Accessory Note 9 | | Special Accessory Note 24 | |
| Special Accessory Note 10 | | Special Accessory Note 25 | |
| Special Accessory Note 11 | | Special Accessory Note 26 | |
| Special Accessory Note 12 | | Special Accessory Note 27 | |
| Special Accessory Note 13 | | Special Accessory Note 28 | |
| Special Accessory Note 14 | | Special Accessory Note 29 | |
| Special Accessory Note 15 | | Special Accessory Note 30 | |
| Heater in C/B Voltage | | Heater in C/B Watts | |
| Zone 2 Group | | Division 2 Service Factor | |
| Note 1 | | Note 2 | |
| Note 3 | | Note 4 | |
| Note 5 | | Note 6 | |
| Note 7 | | Note 8 | |
| Note 9 | | Note 10 | |
| Note 11 | | Note 12 | |
| Note 13 | | Note 14 | |
| Note 15 | | Note 16 | |
| Note 17 | | Note 18 | |
| Note 19 | | Note 20 | |
| Note 21 | | Note 22 | |

NIDEC MOTOR CORPORATION
ST. LOUIS, MO

TYPICAL NAMEPLATE DATA
ACTUAL MOTOR NAMEPLATE LAYOUT MAY VARY
SOME FIELDS MAY BE OMITTED





159833

Motor Wiring Diagram

9 Lead, Dual Voltage, Delta Connection
Part Winding Start (PWS) on Low Voltage

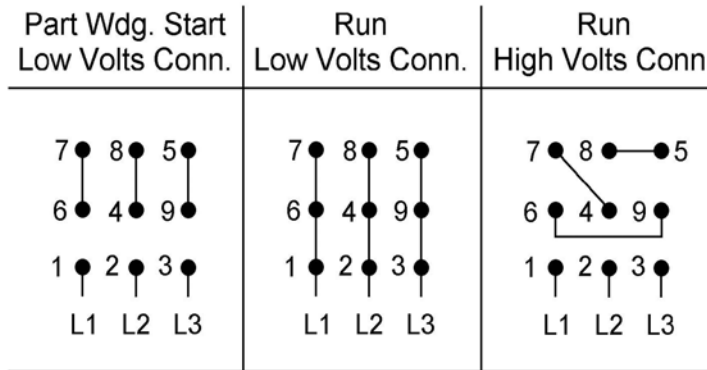

Motor good for across the line starting

Per NEMA MG1 1998-1.75, "A Part-winding Start motor is one which certain specially designed circuits of each phase of the primary winding are initially connected to the supply line. The remaining circuit or circuits of each phase are connected to the supply in parallel with initially connected circuits, at a predetermined point in the starting operation." This is intended to limit the inrush current required to start the motor. NEMA MG1 1998-14.38 states that the motor may not accelerate to full speed in part-winding and may be noisier than when on full winding.

Motors designed by US Motors for Part-winding Start also be used for across the line starting using only the full winding connection. Damage will occur if the motor is operated with load for more than 2 seconds on Part-winding without transition to full winding.

To reverse direction of rotation, interchange leads L1 & L2.

Each lead may have one or more cables comprising that lead. In such case, each cable will be marked with the appropriate lead number.



159833

SPECIAL INFORMATION REGARDING PART WINDING STARTING

This motor is not designed to fully accelerate when started with the part winding start connection shown on the motor connection diagram. In order to avoid damaging the motor when it is started with the part winding start connection, set timers so that the motor starter switches the motor connection from start to run within two seconds from the time that the motor is initially energized. The motor is not expected to fully accelerate before the motor connection is switched to run, but the momentary operation on the start connection should allow time for automatic voltage regulators on the power system to compensate for voltage dip resulting from the high current draw of the motor during acceleration. Thus, voltage dip in the power system will be minimized through proper use of the part winding start connection. Once the motor has been switched over to the run connection, it will finish accelerating up to full speed.

During the time that the motor is operated on the part winding start connection, it is expected that the motor may be noisier than when operated on the run connection and it is also expected that the line amp unbalance between phases may be approximately 100% to 150%. This is due to the adverse effect of harmonics that result from the unbalanced magnetic circuit on the part winding start connection.

For further information regarding characteristics of polyphase induction motors when operated on a part winding start connection, refer to NEMA Publication MG 1-1998 Part 14.38.



970798

SPACE HEATER CONNECTION DIAGRAM

SPACE HEATER LEADS MAY BE LOCATED IN EITHER THE MAIN OUTLET BOX
OR IF SO EQUIPPED, AN AUXILIARY BOX

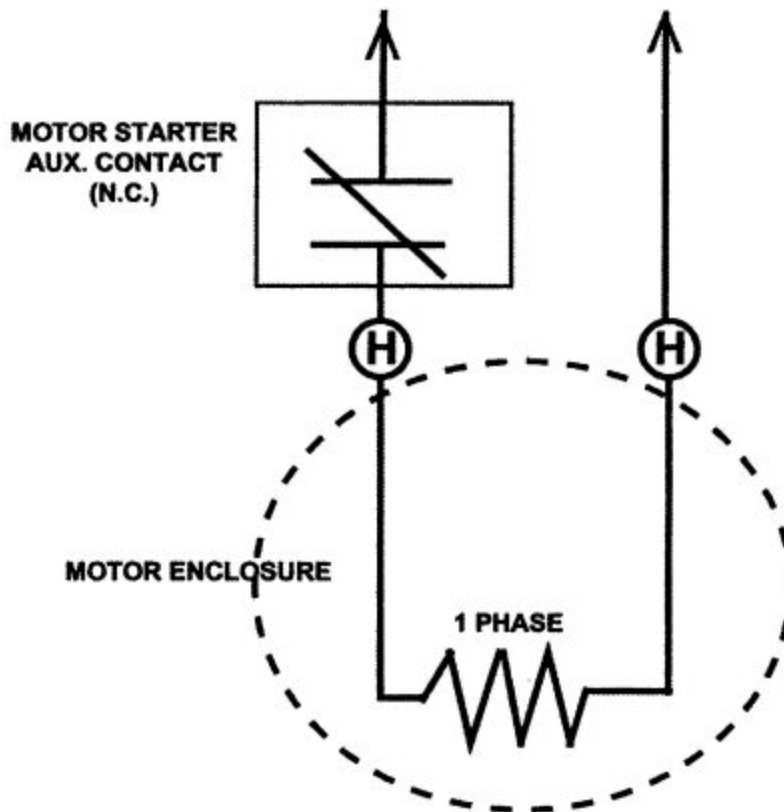

THIS EQUIPMENT IS SUPPLIED WITH ANTI-CONDENSATION HEATERS. HEATERS SHOULD BE ENERGIZED WHEN EQUIPMENT IS NOT OPERATING TO PROTECT UNIT BY PREVENTING INTERNAL CONDENSATION. CONNECT THE "H" OR HEATER LEADS TO

| | |
|-------------------|-------------------------|
| 115V VOLTS | 48W WATTS RATING |
|-------------------|-------------------------|

SPACE HEATER NAMEPLATE (ON MOTOR)

RENEWAL PARTS

FRAMES 254 THRU 286 - OPEN DRIPPROOF

TYPES: AU, AUE, AUI, AV, AV4, AV9, AVE, AVE4, AVI, AVI4, AU, AUE, AUI, AV, AV4, AVE, AVE4, AVI, AVI4

HIGH THRUST HOLLOSHAFT AND SOLIDSHAFT MOTORS

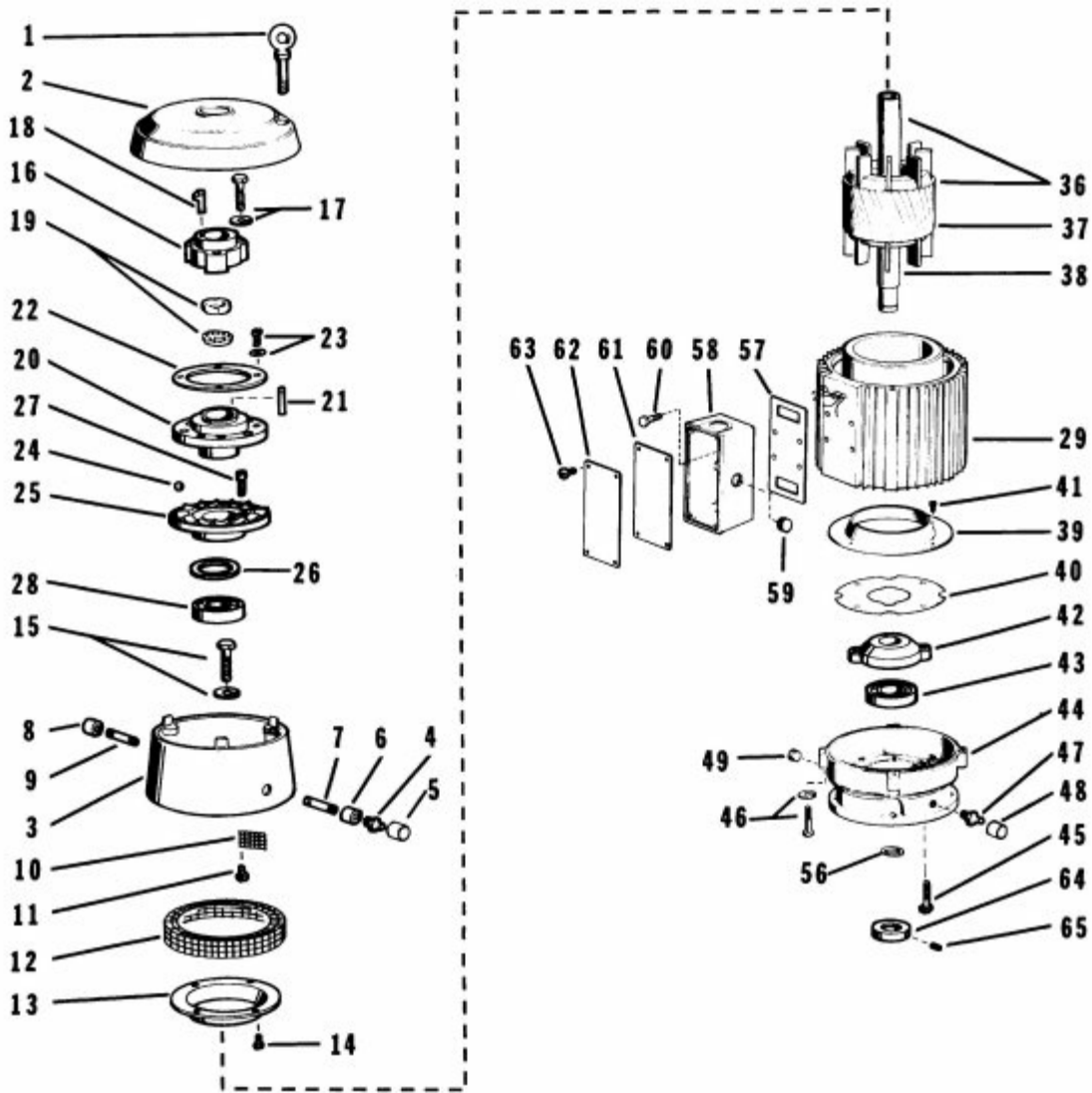

| ITEM NO. | QTY | NAME OF PART |
|----------|-----|------------------------------|
| 1 | 2 | Eyebolt |
| 2 | 1 | Canopy Cap |
| 3 | 1 | Upper Bracket |
| 4 | 1 | Grease Fitting |
| 5 | 1 | Plastic Cap (Grease Fitting) |

WARNING:

Any disassembly or repair work on explosionproof motors will void the Underwriters Laboratories, Inc. label unless done by the manufacturer, or a facility approved by the Underwriters Laboratories, Inc. Refer to your nearest sales office for assistance.

BEARINGS:

Refer to motor nameplate for the bearing numbers.

PRICES:

Parts stocking distributors: refer to renewal parts numerical index. All Others: refer to your nearest parts distributor.

RENEWAL PARTS

FRAMES 254 THRU 286 - OPEN DRIPPROOF
 TYPES: AU, AUE, AUI, AV, AV4, AV9, AVE, AVE4, AVI, AVI4, AU, AUE, AUI, AV, AV4, AVE, AVE4, AVI, AVI4

HIGH THRUST HOLLOSHAFT AND SOLIDSHAFT MOTORS

| ITEM NO. | QTY | NAME OF PART |
|----------|--------|---|
| 6 | 1 | Pipe Coupling |
| 7 | 1 | Nipple Fitting |
| 8 | 1 | Pipe Cap (Plug) |
| 9 | 1 | Nipple Fitting |
| 10 | 4 | Bracket Screen (Intake) |
| 11 | 4 | Screws & Washers (Intake Screen) |
| 12 | 1 | Bracket Screen (Exhaust) |
| 13 | 1 | Air Deflector (Upper) |
| 14 | 4 | Screw (Air Deflector & Screen) |
| 15 | 4 | Screw & Lockwasher (Bracket to Stator) |
| 16 | 1 | Drive Coupling |
| 17 | 3 | Screw & Lockwasher (Drive Coupling) |
| 18 | 1 | Gib Key |
| 19 | 1 | Locknut & Lockwasher |
| 20 | 1 | Rotating Ratchet |
| 21 | 1 | Square Key |
| 22 | 1 | Ball Retaining Ring |
| 23 | 4 | Screw & Lockwasher (Ring) |
| 24 | 10 | Steel Balls (Optional) |
| 25 | 1 | Stationary Ratchet |
| 26 | As Req | Shims |
| 27 | 3 | Socket Head Cap Screw (Stationary Ratchet) |
| 28 | 1 | Ball Bearing (Upper) (Refer to Section 775) |
| 29 | 1 | Wound Stator Assembly |
| 30-35 | - | NOT USED IN THIS ASSEMBLY |

| ITEM NO. | QTY | NAME OF PART |
|----------|-----|---|
| 36 | 1 | Rotor Assembly (Includes Items 37 & 38) |
| 37 | 1 | Rotor Core |
| 38 | 1 | Rotor Shaft |
| 39 | 1 | Air Deflector (Lower) |
| 40 | 1 | Bracket Screen |
| 41 | 4 | Screw (Air Deflector) |
| 42 | 1 | Bearing Cap (Lower) |
| 43 | 1 | Ball Bearing (Lower) (Refer to Section 775) |
| 44 | 1 | Lower Bracket |
| 45 | 2 | Screw & Lockwasher (Bearing Cap) |
| 46 | 4 | Screw & Lockwasher (Bracket to Stator) |
| 47 | 1 | Grease Fitting |
| 48 | 1 | Plastic Cap (Grease Fitting) |
| 49 | 1 | Pipe Plug |
| 50-55 | - | NOT USED IN THIS ASSEMBLY |
| 56 | 1 | Water Deflector |
| 57 | 1 | Gasket (Outlet Box to Base) |
| 58 | 1 | Outlet Box Base |
| 59 | 1 | Pipe Plug |
| 60 | 4 | Screw |
| 61 | 1 | Gasket (Outlet Box Cover) |
| 62 | 1 | Outlet Box Cover |
| 63 | 4 | Screw |
| 64 | 1 | Stabilizer Bushing (Optional) |
| 65 | 1 | Screw (Optional) |

* With optional Stabilizer Bushing, delete Item No. 56 and add Items 64 & 65

WARNING:

Any disassembly or repair work on explosionproof motors will void the Underwriters Laboratories, Inc. label unless done by the manufacturer, or a facility approved by the Underwriters Laboratories, Inc. Refer to your nearest sales office for assistance.

BEARINGS:

Refer to motor nameplate for the bearing numbers.

PRICES:

Parts stocking distributors: refer to renewal parts numerical index. All Others: refer to your nearest parts distributor.

reference: Renewal Parts Section 700, Pages 147 & 148

Vertical HOLLOSHAFT Coupling Dimensions

Standard Coupling Dimensions

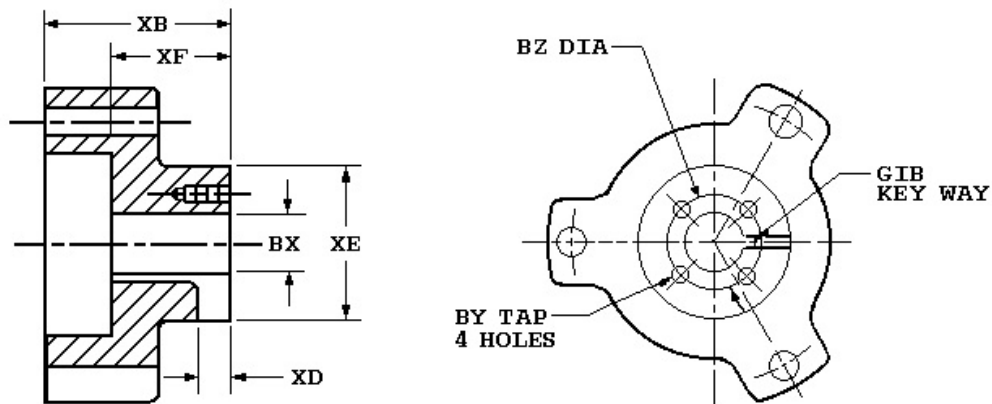

| | |
|----------------------|--------|
| Coupling Part Number | 102999 |
| BX Nominal | 1 |
| Actual Bore | 1.001 |
| BY | 10-32 |
| BZ | 1 3/8 |
| XB | 2 9/16 |
| XD | 13/32 |
| XE | 2 1/4 |
| XF | 1 5/8 |
| SQ. KEY | 1/4 |

Notes:

1. All Rough casting dimensions may vary by 0.25" due to casting variations.
2. All tapped holes are Unified National Course, Right Hand thread.
3. Coupling bore dimension "BX" is machined with a tolerance of $-.000$, $+.001$ " up to 1.50" bore inclusive. Larger bores: $-.000$, $+.002$ ".



Copyright © 2010 Nidec Motor Corporation. All rights reserved.

TYPICAL REED CRITICAL FREQUENCY DATA

Note: Motor RCF Test Data can be provided at time of motor shipment through special test.
Please contact your Nidec Motor Corporation representative for more information.

MODEL NO: BF32
CATALOG NO: HO20V2BLF

Frame: 256TPH Type: AUI

| | | |
|---------------------------------|-----------|-----|
| REED CRITICAL FREQUENCY: | 78 | HZ |
| CENTER OF GRAVITY: | 11 | IN |
| DEFLECTION @ CENTER OF GRAVITY: | 0.0016 | IN |
| UNIT WEIGHT: | 300 | LBS |
| BASE DIAMETER: | ALL | IN |
| TOLERANCE ON RCF VALUE: | 10% | |
| DATE: | 4/20/2022 | |



Copyright © 2010 Nidec Motor Corporation. All rights reserved.

General Information for Integral Horsepower (IHP) Motors on Variable Frequency Drives (VFDs)

Variable Frequency Drives (VFD)

A VFD is a type of controller used to vary the speed of an electric motor. The VFD takes a fixed AC voltage and frequency and allows it to be adjusted in order to get different speeds from the motor. Motor speed can be varied by changing the frequency of the input power waveform. The equation below shows how the frequency affects the speed of a three phase induction motor.

$$\text{Speed} = \frac{120 * \text{Fundamental Input Frequency}}{\text{Number of Motor Poles}}$$

How does a VFD work?

A VFD takes the fixed frequency and voltage sine wave from the power grid or power station and puts it through a few steps in order to allow the VFD user to vary the frequency and in turn control the motor speed. First it rectifies the AC power into DC Power. Because of this step, a term commonly used instead of VFD is inverter. This only describes one step of what the VFD does to the power waveform. Once rectified into a DC voltage the drive sends the power through a set of transistors or switches. These switches can take the DC waveform and by opening and closing at certain speeds and durations can create an output waveform that mimics the sine wave that is required to drive a three phase electric motor. The output wave form is known as a Pulse Width Modulation (PWM) waveform because the waveform is created by multiple pulses of the switches at short intervals.

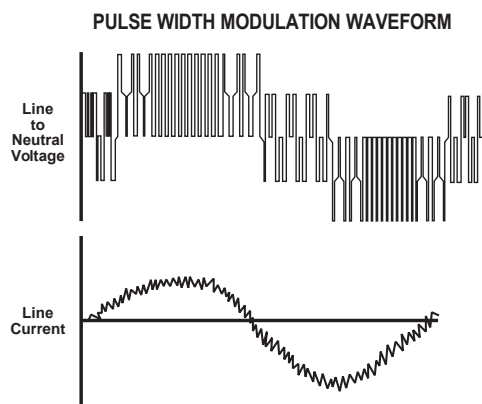

Figure 1 PWM Waveform

What variables should be considered when deciding whether to power a motor with a VFD?

VFD compatibility with motors is complex. As a result, many variables must be considered when determining the suitability of a particular motor for use with a VFD. These variables include:

- Torque requirements (Constant or Variable)
- Speed Range
- Line / System Voltage
- Cable length between the VFD and the motor
- Drive switching (carrier) frequency
- Motor construction

- VFD dv/dt - winding end turn differential in voltage versus differential in time
- High temperatures or high humidity
- Grounding system

Wider speed ranges, higher voltages, higher switching frequencies, insufficient grounding and increased cable lengths all add to the severity of the application and, therefore, the potential for premature motor failure.

How does a VFD affect the motor?

There are many things to consider when a motor is powered using a VFD or PWM power. When a motor is powered by a PWM waveform the motor windings very often see a large differential voltage, either from phase to phase or turn to turn. When the voltage differential becomes large enough it creates a reaction at the molecular level that converts available oxygen into O₃. This phenomenon is called partial discharge or corona. This reaction creates energy in the form of light and heat. This energy has a corrosive effect on the varnish used to protect the motor windings. PWM waveforms can also magnify shaft voltages which lead to arcing across the bearing and causing premature bearing failure. Corrective action must be taken to mitigate these issues that arise when using an electric motor with a VFD.

How do I protect the motor?

Nidec Motor Corporation (NMC) has developed specific motor designs to decrease the harmful affects that a VFD can have on a motor. NMC's INVERTER GRADE[®] insulation system is the first line of defense against corona and phase to phase faults that can be common when a motor is powered using a PWM waveform. The INVERTER GRADE[®] insulation system is standard on all of NMC's Inverter Duty products. Along with the INVERTER GRADE[®] insulation, thermostats are installed as a minimum protection against overheating the motor. Special consideration must also be given to bearings in motors powered by VFD's. In order to create a low resistance path to ground for built up shaft voltages a shaft grounding device can be used. On larger horsepower motors an insulated bearing system should be used in conjunction with the shaft grounding device when installed, to force the stray shaft voltages to ground. The bearing failures are more prominent on motors with thrust handling bearings. NMC has created an Inverter Duty vertical motor line that not only uses the INVERTER GRADE[®] insulation system, but that also comes standard with a shaft grounding device. On motors that are 100 HP and greater the thrust bearing is also insulated for additional protection.

What does "Inverter Duty" mean?

An Inverter Duty motor should describe a motor that helps mitigate potential failure modes of a motor that is powered by a VFD. Inverter duty motor windings should be able to withstand the voltage spikes per NEMA MG1 Part 31.4.4.2 and protect against overheating when the motor is run at slow speeds. On thrust handling bearings it is apparent that the bearings require additional protection. Inverter Duty vertical motors should have a shaft grounding device to protect the motor bearings from fluting due to voltage discharge through the bearing. On larger motors (100HP and larger) the shaft should also be electrically isolated from the frame in order to aid the shaft grounding ring in discharging the shaft voltages to ground.

*This information applies only to Integral Horsepower (IHP) motors as defined on the Agency Approval page, under UL[®] & CSA[®] listings where indicated.

Thermal Overloads and Single Phase Motors

Motors with thermal overloads installed may not operate properly on a VFD. The current carrying thermal overload is designed for sine wave power. Operation on a VFD may cause nuisance tripping or potentially not protect the motor as would be expected on line power. Thermostats or thermistors installed in the motor and connected properly to the VFD may provide suitable thermal overload protection when operating on a VFD. (consult codes for installation requirements)

Single phase motors and other fractional horsepower ratings are not designed to be operated on a VFD. Within Nidec Motor Corporation standard products, all motors NEMA[®] 48 frame (5.5" diameter) and smaller are not suitable for VFD applications. Three phase 56 and 143/145 frame applications should be noted on the catalog price page; or if in doubt ask a Nidec Motor Corporation technical representative for recommendations on compatibility with a VFD.

Slow Speed Motors

Motors with a base design of slower than six poles require special consideration regarding VFD sizing and minimizing harmonic distortion created at the motor terminals due to cable installation characteristics. Additional external PWM waveform filters and shielded motor cables designed for PWM power may be required to provide acceptable motor life. Harmonic distortion on the output waveform should be kept to a minimum level (less than 10%) mismatch impedance.

690V Applications

Motors that are rated for 690VAC and that will be powered by 690VAC PWM VFDs require the use of an external filter to limit peak voltage spikes and the use of an INVERTER GRADE[®] motor. Where available, an alternative to using an output filter is to upgrade to a 2300V insulation system.

Low Voltage TITAN[®] Motors

When using 449 frame and larger motors on PWM type VFDs consider the use of an external filter and shielded motor cables designed for PWM power to minimize harmonic distortion and peak voltages at the motor terminals. Harmonic distortion on the output waveform should be kept to a minimum level (less than 10%).

Bearing Currents Related to PWM Waveforms

Protection of the motor bearings from shaft currents caused by common mode voltages is becoming a standard feature on Inverter Duty motor products. Some installations may be prone to a voltage discharge condition through the motor bearings called Electrical Discharge Machining (EDM) or fluting. Vertical HOLLOWSHAFT and HOSTILE DUTY World Motor come with grounding devices installed as standard. EDM damage is related to characteristics of the PWM waveform, and the VFD programming, and installations factors.

Bearing Protection on Inverter Duty Vertical Motors

All U.S. MOTORS[®] brand "Inverter Duty" vertical products have a shaft grounding system that allows damaging shaft currents a low resistance path to ground. **Bearings on vertical motors fed by VFD power without this bearing protection are not covered under any warranty.** All other bearing failure is covered per NMC's standard warranty. An electric motor repair shop approved to service U.S. MOTORS[®] brand motors must verify that the cause of the bearing failure was not due to EDM damage.

Guideline For Insulated Anti-Friction Bearings

Bearing insulation is required to prevent circulating shaft currents which can damage bearings. Circulating shaft current can be caused by use of improper power and/or ground cables, improper grounding systems and higher switching frequencies. Finding and correcting the external condition(s) is the responsibility of the system designer or specifying engineer. To prevent circulating shaft current in motors with anti-friction bearings, Nidec Motor Corporation's standard practice is to insulate the non-drive end bearing.

Adjustable Speed Drives produce a common mode voltage condition. To interrupt common mode voltage on induction motors of all sizes, NEMA MG1-2018 Part 31 recommends insulating both bearings. In cases where both anti-friction bearings are insulated, the system designer or specifying engineer should determine whether to apply one or more of the following options to prevent or reduce shaft currents: sinewave filters, line reactors or mechanical devices, such as shaft grounding or an insulated half coupling. Motors with shaft grounding devices are not suitable for installation in hazardous locations unless housed in an enclosure suitable for the specified Division (or Zone), Class and Group(s).

Multiple Motors on a Single VFD

Special considerations are required when multiple motors are powered from a single VFD unit. Most VFD manufacturers can provide guidelines for proper motor thermal considerations and starting/stopping of motors. Cable runs from the VFD and each motor can create conditions that will cause extra stress on the motor winding. Filters may be required at the motor to provide maximum motor life.

Grounding and Cable Installation Guidelines

Proper output winding and grounding practices can be instrumental in minimizing motor related failures caused by PWM waveform characteristics and installation factors. VFD manufacturers typically provide detailed guidelines on the proper grounding of the motor to the VFD and output cable routing. Cabling manufacturers provide recommended cable types for PWM installations and critical information concerning output wiring impedance and capacitance to ground.

Integrated Motor and Inverter

By integrating the motor and inverter at NMC's manufacturing facility, many of the motor compatibility problems are minimized or eliminated. During the manufacturing process, the motor is matched to the inverter characteristics which ensures the winding temperature and torque levels meet the design specification. Since the inverter output wiring to the motor is nearly eliminated, bearing currents are rarely experienced. When the unit is properly grounded, reducing the output cable lengths in conjunction with an inverter grade insulation system and low factory setting of the switching frequency of the inverter drive, results in low risk of voltage peaks produced by the PWM waveform.

Vertical Motors on VFDs

Vertical motors operated on VFD power present unique conditions that may require consideration by the user or installation engineer:

- Locked rotor and drive tripping caused by non-reversing-ratchet operation at low motor speeds. It is not recommended to operate motors at less than 1/4 of synchronous speed. If slow speeds are required contact NMC engineering.
- Unexpected / unacceptable system vibration and or noise levels caused by the torque pulsation characteristics of the PWM waveform, a system critical frequency falling inside the variable speed range of the process or the added harmonic content of the PWM waveform exciting a system component
- Application related problems related to the controlled acceleration/deceleration and torque of the motor on VFD power and the building of system pressure/ load.
- The impact the reduction of pump speed has on the down thrust reflected to the pump motor and any minimum thrust requirements of the motor bearings
- Water hammer during shutdown damaging the non-reversing ratchet

Humidity and Non-operational Conditions

The possible build-up of condensation inside the motor due to storage in an uncontrolled environment or non-operational periods in an installation, can lead to an increased rate of premature winding or bearing failures when combined with the stresses associated with PWM waveform characteristics. Moisture and condensation in and on the motor winding over time can provide tracking paths to ground, lower the resistance of the motor winding to ground, and lower the Corona Inception Voltage (CIV) level of the winding.

Proper storage and maintenance guidelines are important to minimize the potential of premature failures. Space heaters or trickle voltage heating methods are the common methods for drying out a winding that has low resistance readings. **Damage caused by these factors are not covered by the limited warranty provided for the motor unless appropriate heating methods are properly utilized during non-operational periods and prior to motor start-up.**

NEMA[®] Application Guide for AC Adjustable Speed Drive Systems: <http://www.nema.org/stds/acadjustable.cfm#download>

* This information applies only to Integral Horsepower (IHP) motors as defined on the Agency Approval page, under UL[®] & CSA[®] listings where indicated.

Warranty Guidelines for Integral Horsepower (IHP)* Motors on Variable Frequency Drives

Warranty Guidelines

The information in the following section refers to the motor and drive application guidelines and limitations for warranty.

Hazardous Location Motors

Use of a variable frequency drive with the motors in this catalog, intended for use in hazardous locations, is only approved for Division 1, Class I, Group D hazardous location motors with a T2B temperature code, with a limitation of 2:1 constant torque or 10:1 variable torque output. **No other stock hazardous location motors are inherently suitable for operation with a variable frequency drive.** If other requirements are needed, including non-listed Division 2, please contact your Nidec Motor Corporation territory manager to conduct an engineering inquiry.

575 Volt Motors

575 volt motors can be applied on Inverters when output filters are used. Contact the drive manufacturer for filter selection and installation requirements.

Applying INVERTER GRADE® Insulated Motors on Variable Frequency Drives (2, 4, 6 pole)

The products within this catalog labeled “Inverter Duty” or “Vector Duty” are considered INVERTER GRADE® insulated motors. INVERTER GRADE® motors exceed the NEMA® MG-1 Part 31 standard. Nidec Motor Corporation provides a three-year limited warranty on all NEMA® frame INVERTER GRADE® insulated motors and allows long cable runs between the motor and the VFD (limited to 400 feet without output filters). Cable distance can be further limited by hot and humid environments and VFD manufacturers cable limits. These motors may be appropriate for certain severe inverter applications or when the factors relating to the end use application are undefined (such as spares).

Nidec Motor Corporation’s U.S. Motors® brand is available in the following INVERTER GRADE® insulated motors:

- Inverter Duty NEMA® frame motors good for 20:1 Variable Torque & 5:1 Constant Torque, including Vertical Type RUSI (10:1 V.T.)
- Inverter Duty motors rated for 20:1 Constant Torque
- ACCU-Torq® and Vector Duty Motors with full torque to 0 Speed or 5000:1
- 841 Plus® NEMA® Frame Motors

Applying Premium Efficient motors (that do not have INVERTER GRADE® insulation) on Variable Frequency Drives (2, 4, 6 pole)

Premium efficient motors without INVERTER GRADE insulation meet minimum NEMA® MG-1, Section IV, Part 31.4.4.2. These motors can be used with Variable Frequency Drives (with a reduced warranty period) under the following parameters:

- On NEMA® frame 447 and smaller motors, 20:1 speed rating on variable torque loads & 4:1 speed range on constant torque loads.
- On TITAN® 449 and larger frame motors, 10:1 speed rating on variable torque loads.

- On TITAN® frame motors, inquiry required for suitability on constant torque loads.

Cable distances are for reference only and can be further limited by hot and humid environments (refer to Table 1). Refer to specific VFD

| Table 1 - Cable Distances | | | |
|-------------------------------------|----------|----------|----------|
| Maximum Cable Distance VFD to Motor | | | |
| Switching Frequency | 460 Volt | 230 Volt | 380 Volt |
| 3 KHz | 127 ft | 400 ft | 218 ft |
| 6 KHz | 90 ft | 307 ft | 154 ft |
| 9 KHz | 73 ft | 251 ft | 126 ft |
| 12 KHz | 64 ft | 217 ft | 109 ft |
| 15 KHz | 57 ft | 194 ft | 98 ft |
| 20 KHz | 49 ft | 168 ft | 85 ft |

manufacturers cable limits. Refer to the Motor/ Inverter Compatibility page for special consideration of vertical motor bearings.

Warranty Period Clarifications and Exceptions

Standard Energy Efficient Exclusion

Applying Standard & Energy Efficient Motors on Variable Frequency Drives is not recommended. VFD related failures on standard and energy efficient motors will not be covered under warranty.

Vertical Motor Windings

Premium efficient vertical motors without INVERTER GRADE® insulation that are installed using the criteria described in this document and applied in the correct applications shall have a warranty while powered by a VFD for 12 months from date of installation or 18 months from date of manufacturing whichever comes first. See limited warranty page for horizontal motor warranty periods.

Bearing Exclusion for Thrust Handling Bearings

Bearings used in premium efficient vertical motors, and all thrust handling bearings, that are powered by VFDs without shaft grounding devices or insulated bearings (when required) will not be covered under any warranty for damages caused from being powered by a VFD. All other bearing failure is covered per NMC’s standard warranty. An electric motor repair shop approved to service U.S. MOTORS® brand motors must verify that the cause of the bearing failure was not due to Electrical Discharge Machining.

Medium Voltage and Slow Speed Considerations

Motors that are rated above 700 VAC or that are eight pole and slower require special consideration and installation and are not covered under the warranty guidelines in this document. Motors that are rated above 700VAC have special cable length and voltage differential issues that are specific to the VFD type and manufacture. The motor construction and cost may vary dramatically depending on the VFD topology and construction. Contact your NMC representative with VFD manufacturer name and model type for application and motor construction considerations. Motors that are designed eight pole and slower also require special installation and filters per the drive manufacturer.

* This information applies only to Integral Horsepower (IHP) motors as defined on the Agency Approval page, under UL® & CSA® listings where indicated.