

PRODUCT INFORMATION PACKET

Model No: LM32845

Catalog No: LM32845

General Purpose Motor, 150 HP, 3 Ph, 60 Hz, 460 V, 1800 RPM, 445TSC Frame, TEFC



Regal and are trademarks of Regal Rexnord Corporation or one of its affiliated companies.
©2022 Regal Rexnord Corporation, All Rights Reserved. MC017097E

Nameplate Specifications

Output HP	150 Hp	Output KW	112.0 kW
Frequency	60 Hz	Voltage	460 V
Current	168.0 A	Speed	1785 rpm
Service Factor	1.15	Phase	3
Efficiency	96.2 %	Power Factor	87
Duty	Continuous	Insulation Class	F
Design Code	B	KVA Code	G
Frame	445TSC	Enclosure	Totally Enclosed Fan Cooled
Thermal Protection	No Protection	Ambient Temperature	40 °C
Drive End Bearing Size	318	Opp Drive End Bearing Size	315
UL	Recognized	CSA	Y
CE	Y	IP Code	43
Number of Speeds	1		

Technical Specifications

Electrical Type	Squirrel Cage Induction Run	Starting Method	Wye Start Delta Run
Poles	4	Rotation	Reversible
Resistance Main	.026 Ohms	Mounting	Rigid Base
Motor Orientation	Horizontal	Drive End Bearing	Ball
Opp Drive End Bearing	Ball	Frame Material	Rolled Steel
Shaft Type	TS	Overall Length	39.74 in
Frame Length	23.17 in	Shaft Diameter	2.375 in
Shaft Extension	4.75 in	Assembly/Box Mounting	F1/F2 CAPABLE
Connection Drawing	A-EE7340-LN	Outline Drawing	XK2F1SC2-2317

THREE PHASE – Y START
Δ RUN MOTOR

START

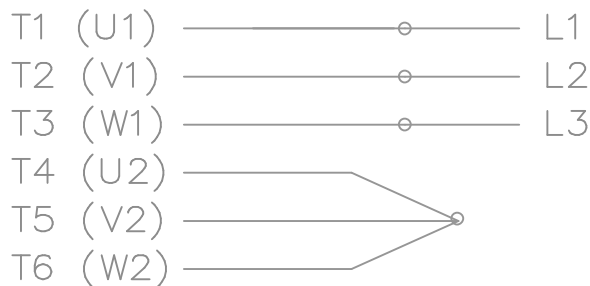

RUN

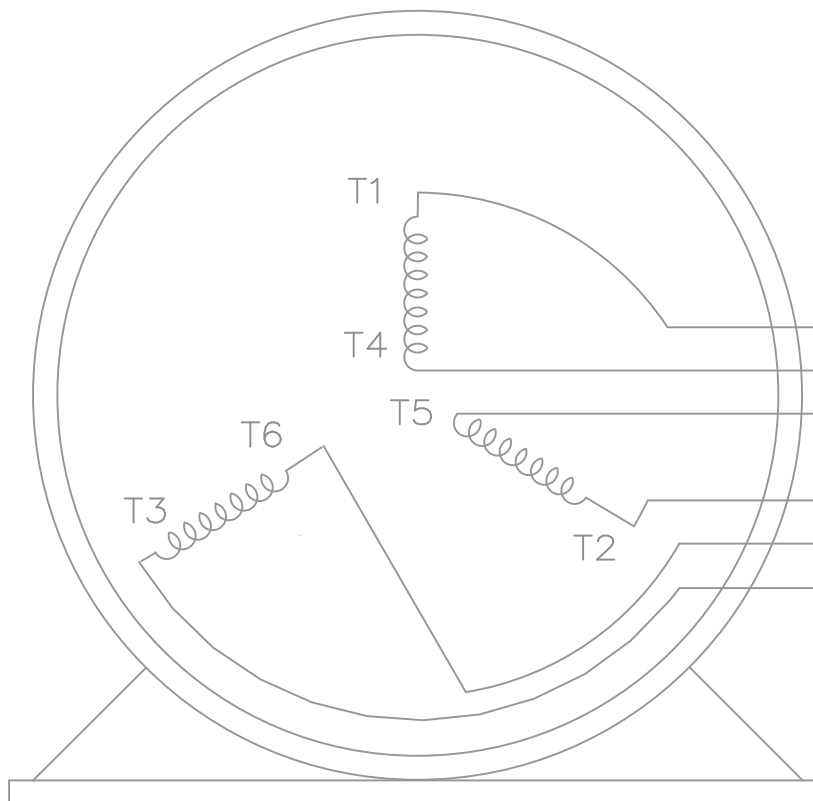
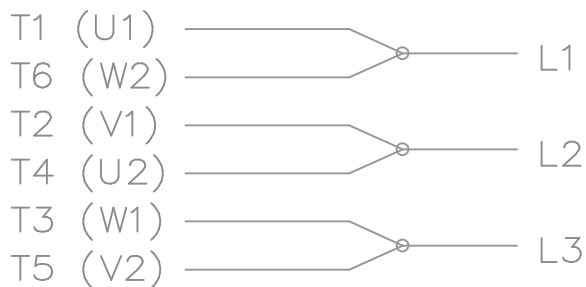

VIEW OF TERMINAL END

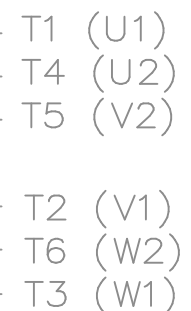

T6CK
T6BM
T4CC
T2DL
T4C

NOTE:
IEC LEAD MARKINGS ARE NOTED
IN PARENTHESES

				TOLERANCES UNLESS SPECIFIED			DRAWN BLR 10-04-1999		
				DEC.	INCHES		CHK DRS 10-04-1999		
				.X	±.1		APPD TB 10-04-1999		
3	REVISED TO MATCH M.E. ORIGINAL	TAT 07-25-2005	ML	.XX	±.02	TITLE CONNECTION DIAGRAM 3Ø – WYE START DELTA RUN	SCALE 1=1		
2	REVISED DRAWING MISTAKE CN 29200-2980	ERH 05-15-2003	ML	.XXX	±.005		REF		
1	NEW DRAWING	BLR 10-09-1999		.XXXX	±.0005		FMF		
NO.	REVISION	BY & DATE	CHK	ANG	±'	FINISH	PREV		
THIS DRAWING IN DESIGN AND DETAIL IS OUR PROPERTY AND MUST NOT BE USED EXCEPT IN CONNECTION WITH OUR WORK ALL RIGHTS OF DESIGN AND INVENTION ARE RESERVED THIS IS AN ELECTRONICALLY GENERATED DOCUMENT – DO NOT SCALE THIS PRINT				RFP	CAD FILE ee7340_In		SIZE	DRAWING NO. PAGE OF	REV.
				DIST	WA-LB-SB		A	EE7340-LN	3



**2100 WASHINGTON ST.
GRAFTON, WI
PH. 262-277-8810**

CERTIFICATION DATA SHEET

CONN. DIAGRAM: A-EE7340-LN

CATALOG #: LM32845

OUTLINE: XK2F1SC2-2317

WINDING #: L4454041 1

MOUNTING: F1/F2 CAPABLE

TYPICAL MOTOR PERFORMANCE DATA

HP	kW	SYNC. RPM	F.L. RPM	FRAME	ENCLOSURE	KVA CODE	DESIGN
150&125	112&93.0	1800	1785&1486	445TSC	TEFC	G	B

PH	Hz	VOLTS	AMPS	START TYPE	DUTY	INSL	S.F.	AMB°C
3	60/50	460&380	168&170	WYE START DELTA RUN	CONTINUOUS	F1	1.15/1.15	40

FULL LOAD EFF:	96.2&95.4	3/4 LOAD EFF:	96.2	1/2 LOAD EFF:	95.4	GTD. EFF	95.4	ELEC. TYPE	SQ CAGE IND RUN
FULL LOAD PF:	87&87	3/4 LOAD PF:	85	1/2 LOAD PF:	79				

F.L. TORQUE	LOCKED ROTOR AMPS	L.R. TORQUE	B.D. TORQUE	F.L. RISE°C
441 LB-FT	1085	935 LB-FT 212 %	1040 LB-FT 236 %	55

SOUND PRESSURE @ 3 FT.	SOUND POWER	ROTOR WK^2	MAX. WK^2	SAFE STALL TIME	STARTS / HOUR	APPROX. MOTOR WGT
0 dBA	10 dBA	0 LB-FT^2	0 LB-FT^2	0 SEC.	0	- LBS.

***** SUPPLEMENTAL INFORMATION *****

DE BRACKET TYPE	ODE BRACKET TYPE	MOUNT TYPE	ORIENTATION	SEVERE DUTY	HAZARDOUS LOCATION	DRIP COVER	SCREENS	PAINT
C-FACE	STANDARD	RIGID	HORIZONTAL	FALSE	NONE	FALSE	NONE	GRAY - LINCOLN

BEARINGS		GREASE	SHAFT TYPE	SPECIAL DE	SPECIAL ODE	SHAFT MATERIAL	FRAME MATERIAL
DE	ODE						
BALL	BALL	POLYREX EM	TS	NONE	NONE	1045 HOT ROLLED (C-204)	ROLLED STEEL
318	315						

THERMO-PROTECTORS				THERMISTORS	CONTROL	SPACE HEATERS
THERMOSTATS	PROTECTORS	WDG RTDs	BRG RTDs			
NONE	NOT	NONE	NONE	NONE	FALSE	NONE VOLTS

*
N
O
T
E
S
*

INVERTER TORQUE: NONE
INV. HP SPEED RANGE: NONE
ENCODER: NONE NONE NONE NONE NONE PPR
BRAKE: NONE NONE NONE P/N NONE NONE NONE FT-LB V NONE Hz

Data Sheet

Date: 1/24/2018

LM32845



Data @ 460 V

Motor Load Data

Load	0%	25%	50%	75%	100%	115%	125%	LR
Current (Amps)	46.5	62.5	92.5	129	168	194	211	1,085
Torque (ft-lb)	0.00	110	220	330	441	508	553	935
RPM	1800	1797	1793	1790	1785	1,784	1782	0
Efficiency (%)		93.6	95.4	96.2	96.2	95.8	95.4	
P.F. (%)	4.5	60.0	79.0	85.0	87.0	87.0	87.0	33.5

Motor Speed Data

	LR	Pull-Up	BD	Rated	Idle
Speed (RPM)	0	900	1725	1785	1800
Current (Amps)	1,085	977	575	168	46.5
Torque (ft-lb)	935	888	1,040	441	0.00

Information Block				
HP	150.0			
Sync. RPM	1800			
Frame	445			
Enclosure	TEFC			
Construction	TFR			
Voltage	460#380 V			
Frequency	60 Hz			
Design	A			
LR Code letter	G			
Service Factor	1.15			
Temp Rise @ FL	55 °C			
Duty	CONT			
Ambient	40 °C			
Elevation	1,000 feet			
Rotor/Shaft wk ²	0.00 Lb-Ft ²			
Ref Wdg	L4454041 NONE			
Sound Pressure @ 1M	999 dBA			
VFD Rating	NONE			
Outline Dwg	XK2F1SC2-2317			
Conn. Diag	A-EE7340-LN			
Additional Specifications:				
0				
0				
EQUIV CKT (OHMS / PHASE)				
R1	R2	X1	X2	Xm
0.0210	0.0130	0.1630	0.2150	5.6700

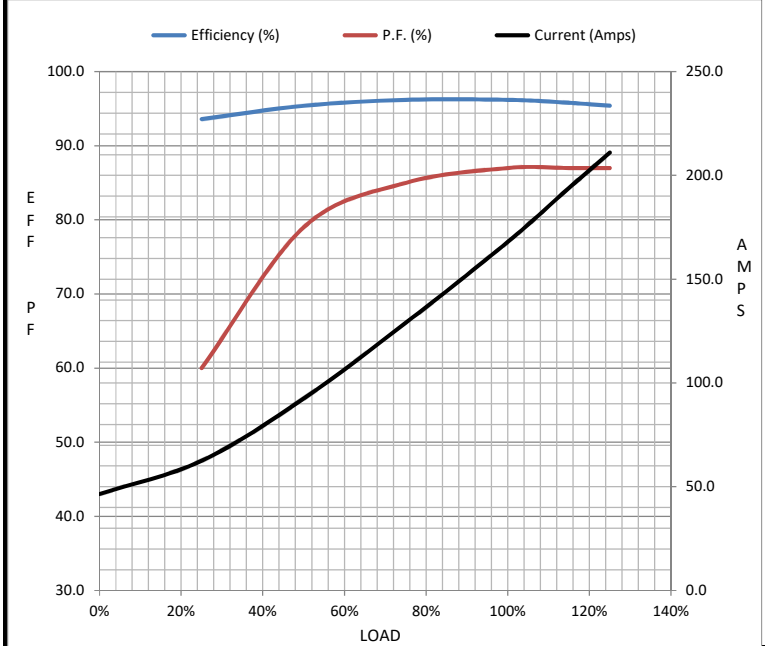

Speed - Torque Curve

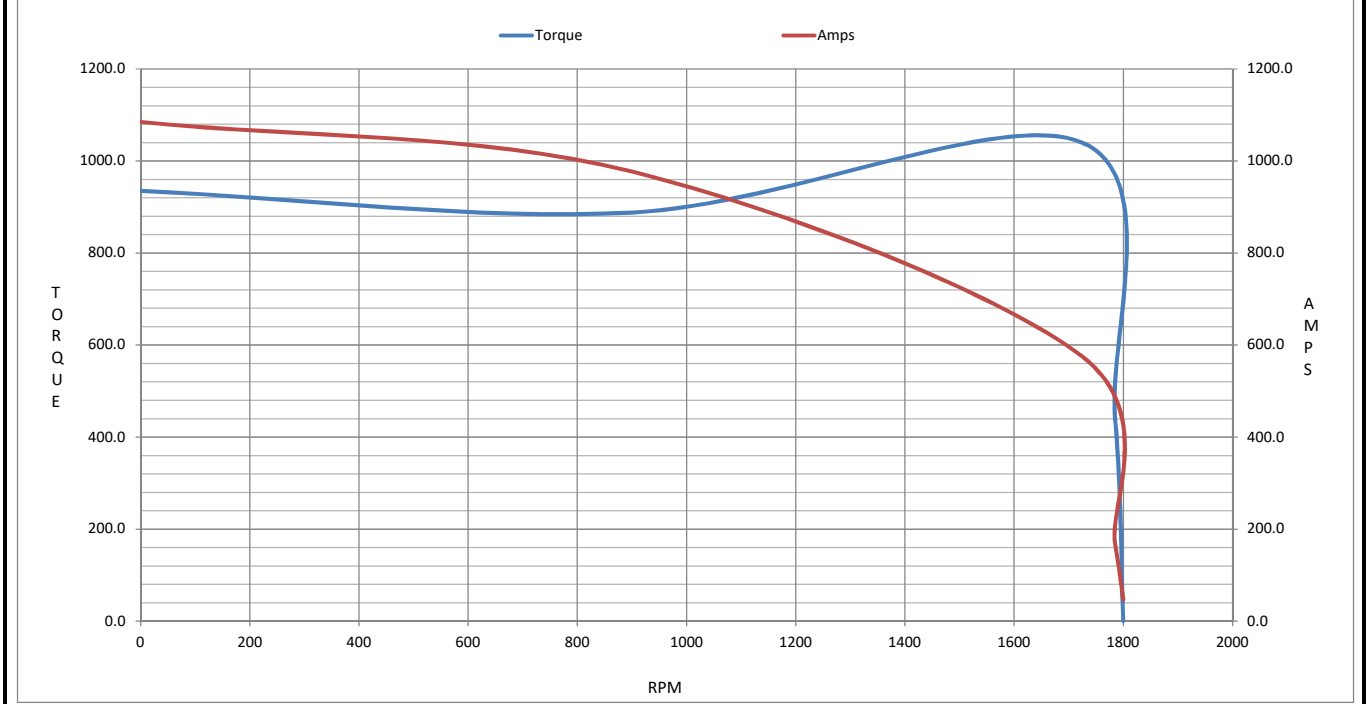

EC Declaration of Conformity

The undersigned representing
the manufacturer:

Regal Beloit America
100 East Randolph St.
Wausau, WI 54401

and the authorized representative
established within the Community:

Marathon Electric UK
6F Thistleton Road Ind. Estate
Market Overton
Oakham, Rutland LE15 7PP UK

are committed to providing customers with products that comply with applicable regulations and international protocols to which they are subject, including the requirements of the European Parliament Directive on the Harmonization of the laws relating to electrical equipment designed for use within certain voltage limits (2014/35/EU).

Regal Beloit America declares that the following product(s), to which this declaration relates, are in conformity with the relevant sections of the EC standards listed below.

This statement supersedes any statements previously issued pertaining to the product(s) listed below and is subject to change without notice.

Model No : LM32845

(Model No. may contain prefix and/or suffix characters)

Catalog No : LM32845

Rework No : N/A

Directives :

Low Voltage Directive 2014/35/EU

Harmonized Standards Used :

EN 60034-1: 2010 (IEC 60034-1: 2010)

EN 60034-5: 2001/A1:2007 (IEC 60034-5: 2000/A1:2006)

Authorized Representative:



Michael A. Logsdon
Vice President, Technology

Authorized Representative in the Community:



Julian Clark
Marketing Engineer

Created on 09/01/2022

CE 22