

DATA SHEET



Three Phase Induction Motor - Squirrel Cage

Customer	:		
Product line	: Premium Efficiency Three-Phase	Product code :	14786536
		Catalog # :	00112ET3E56CFL-S
Frame	: 56C	Cooling method	: IC411 - TEFC
Insulation class	: F	Mounting	: F-1
Duty cycle	: Cont.(S1)	Rotation ¹	: Both (CW and CCW)
Ambient temperature	: -20°C to +40°C	Starting method	: Direct On Line
Altitude	: 1000 m.a.s.l.	Approx. weight ²	: 37.2 lb
Protection degree	: IP55	Moment of inertia (J)	: 0.1597 sq.ft.lb
Design	: B		
Output [HP]	1	1	1
Poles	6	6	6
Frequency [Hz]	60	50	50
Rated voltage [V]	230/460	190/380	220/415
Rated current [A]	3.16/1.58	3.74/1.87	3.41/1.81
L. R. Amperes [A]	18.3/9.16	16.5/8.23	16.7/8.87
LRC [A]	5.8x(Code J)	4.4x(Code F)	4.9x(Code G)
No load current [A]	2.03/1.01	2.00/1.00	2.02/1.07
Rated speed [RPM]	1145	915	930
Slip [%]	4.58	8.50	7.00
Rated torque [ft.lb]	4.59	5.74	5.65
Locked rotor torque [%]	229	170	200
Breakdown torque [%]	280	200	229
Service factor		1.00	1.00
Temperature rise	80 K	105 K	105 K
Locked rotor time	55s (cold) 31s (hot)	54s (cold) 30s (hot)	50s (cold) 28s (hot)
Noise level ²	50.0 dB(A)	48.0 dB(A)	48.0 dB(A)
Efficiency (%)	25%	79.5	80.4
	50%	80.0	79.4
	75%	82.5	80.4
	100%	82.5	78.6
Power Factor	25%	0.28	0.31
	50%	0.50	0.54
	75%	0.63	0.68
	100%	0.72	0.76
Bearing type	: <u>Drive end</u> 6204 ZZ	<u>Non drive end</u> 6202 ZZ	Foundation loads
Sealing	: V'Ring	Without Bearing Seal	Max. traction : 109 lb
Lubrication interval	: -	-	Max. compression : 146 lb
Lubricant amount	: -	-	
Lubricant type	: Mobil Polyrex EM		
Notes			
USABLE @208V 3.50A SF 1.00 SFA 3.50A			
This revision replaces and cancel the previous one, which must be eliminated. (1) Looking the motor from the shaft end. (2) Measured at 1m and with tolerance of +3dB(A). (3) Approximate weight subject to changes after manufacturing process. (4) At 100% of full load.		These are average values based on tests with sinusoidal power supply, subject to the tolerances stipulated in NEMA MG-1.	
Rev.	Changes Summary	Performed	Checked
			Date
Performed by			
Checked by			Page
Date	11/04/2022		Revision
			1 / 13

TORQUE AND CURRENT VS SPEED CURVE

Three Phase Induction Motor - Squirrel Cage



Customer :

Product line : Premium Efficiency Three-Phase Product code : 14786536
 Catalog # : 00112ET3E56CFL-S

TORQUE AND CURRENT VS SPEED CURVE

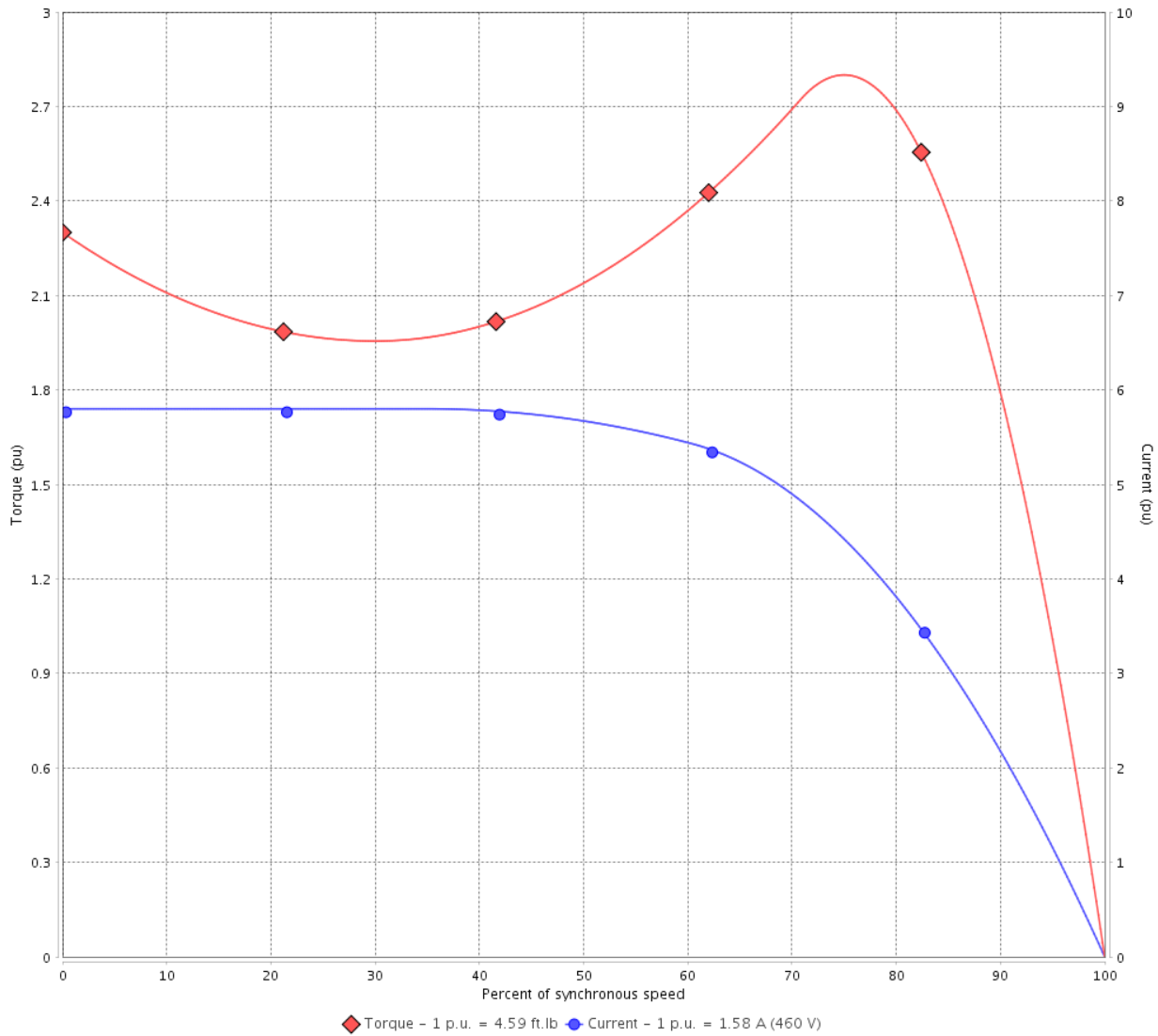

Performance : 230/460 V 60 Hz 6P

Rated current	: 3.16/1.58 A	Moment of inertia (J)	: 0.1597 sq.ft.lb
LRC	: 5.8	Duty cycle	: Cont.(S1)
Rated torque	: 4.59 ft.lb	Insulation class	: F
Locked rotor torque	: 229 %	Service factor	:
Breakdown torque	: 280 %	Temperature rise	: 80 K
Rated speed	: 1145 rpm	Design	: B

Locked rotor time : 55s (cold) 31s (hot)

Rev.	Changes Summary	Performed	Checked	Date
Performed by		Page		Revision
Checked by		2 / 13		
Date	11/04/2022			

TORQUE AND CURRENT VS SPEED CURVE



Three Phase Induction Motor - Squirrel Cage

Customer : _____

Product line : Premium Efficiency Three-Phase

Product code :

14786536

Catalog # :

00112ET3E56CFL-S

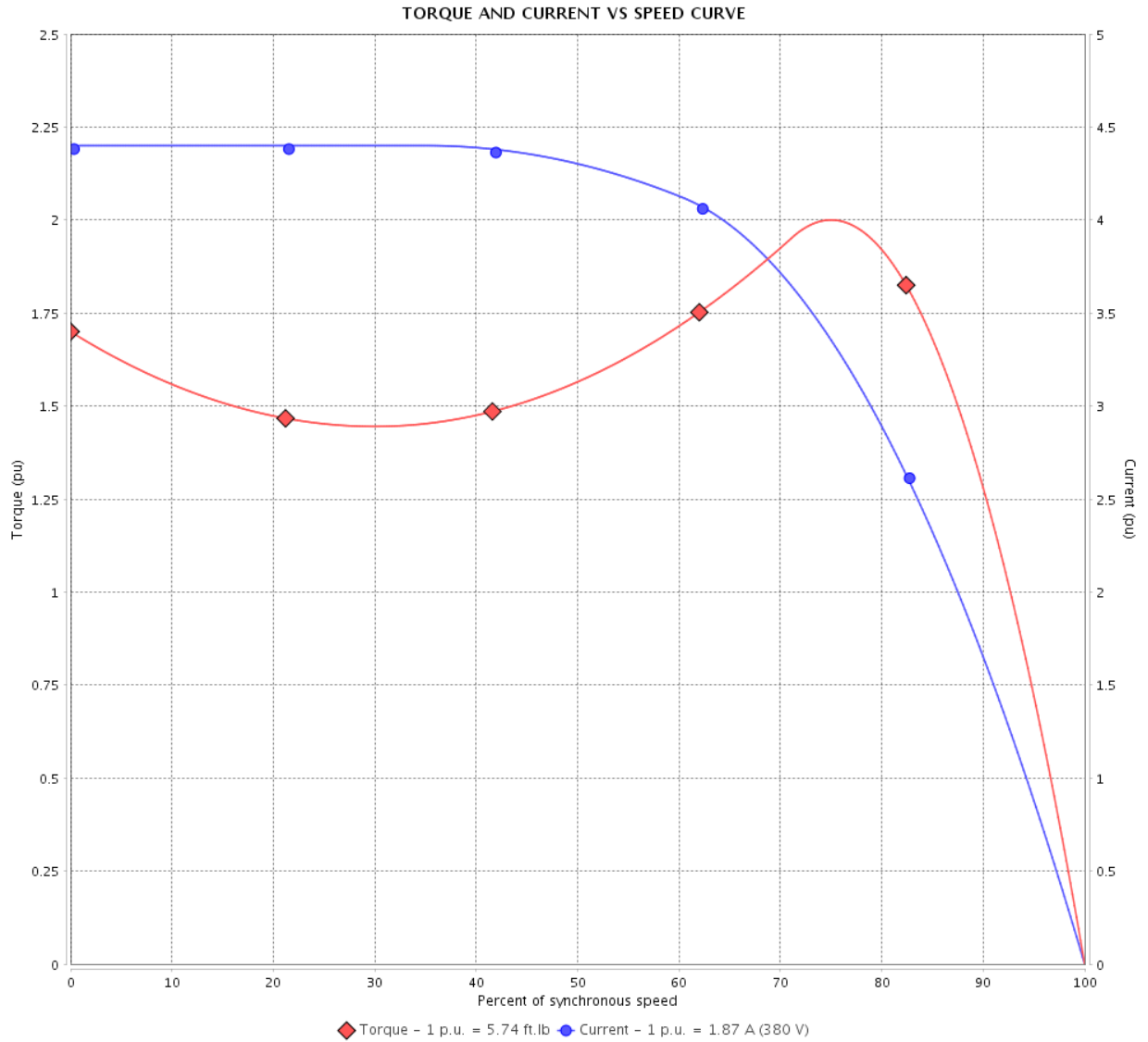

Performance : 190/380 V 50 Hz 6P

Rated current : 3.74/1.87 A
 LRC : 4.4
 Rated torque : 5.74 ft.lb
 Locked rotor torque : 170 %
 Breakdown torque : 200 %
 Rated speed : 915 rpm

Moment of inertia (J) : 0.1597 sq.ft.lb
 Duty cycle : Cont.(S1)
 Insulation class : F
 Service factor : 1.00
 Temperature rise : 105 K
 Design : B

Locked rotor time : 54s (cold) 30s (hot)

Rev.	Changes Summary	Performed	Checked	Date
Performed by			Page 3 / 13	Revision
Checked by				
Date	11/04/2022			

TORQUE AND CURRENT VS SPEED CURVE

Three Phase Induction Motor - Squirrel Cage



Customer :

Product line : Premium Efficiency Three-Phase Product code : 14786536
 Catalog # : 00112ET3E56CFL-S

TORQUE AND CURRENT VS SPEED CURVE

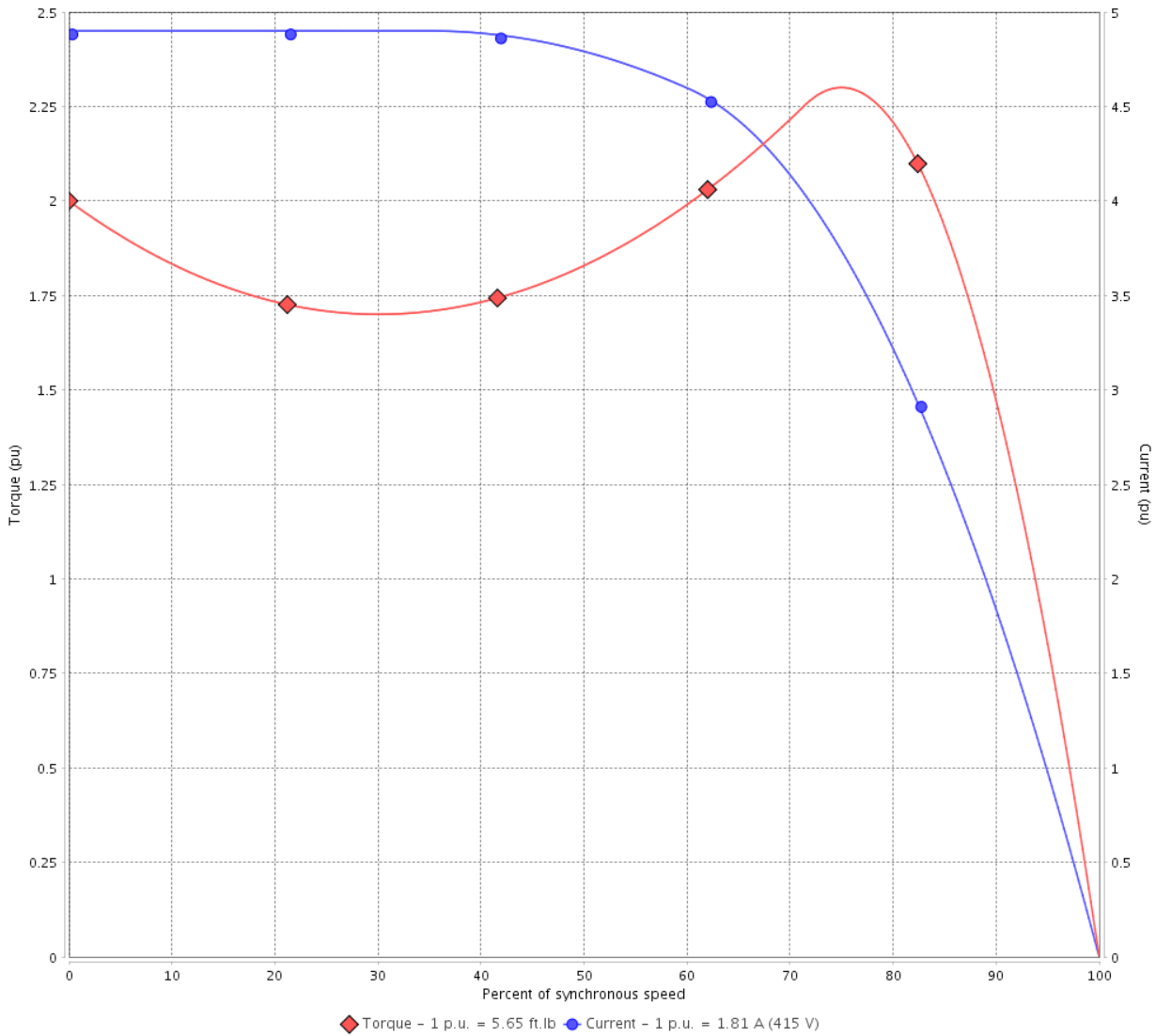

Performance : 220/415 V 50 Hz 6P

Rated current	: 3.41/1.81 A	Moment of inertia (J)	: 0.1597 sq.ft.lb
LRC	: 4.9	Duty cycle	: Cont.(S1)
Rated torque	: 5.65 ft.lb	Insulation class	: F
Locked rotor torque	: 200 %	Service factor	: 1.00
Breakdown torque	: 229 %	Temperature rise	: 105 K
Rated speed	: 930 rpm	Design	: B

Locked rotor time : 50s (cold) 28s (hot)

Rev.	Changes Summary	Performed	Checked	Date
Performed by			Page 4 / 13	Revision
Checked by				
Date	11/04/2022			

LOAD PERFORMANCE CURVE

Three Phase Induction Motor - Squirrel Cage



Customer : _____

Product line : Premium Efficiency Three-Phase Product code : 14786536
 Catalog # : 00112ET3E56CFL-S

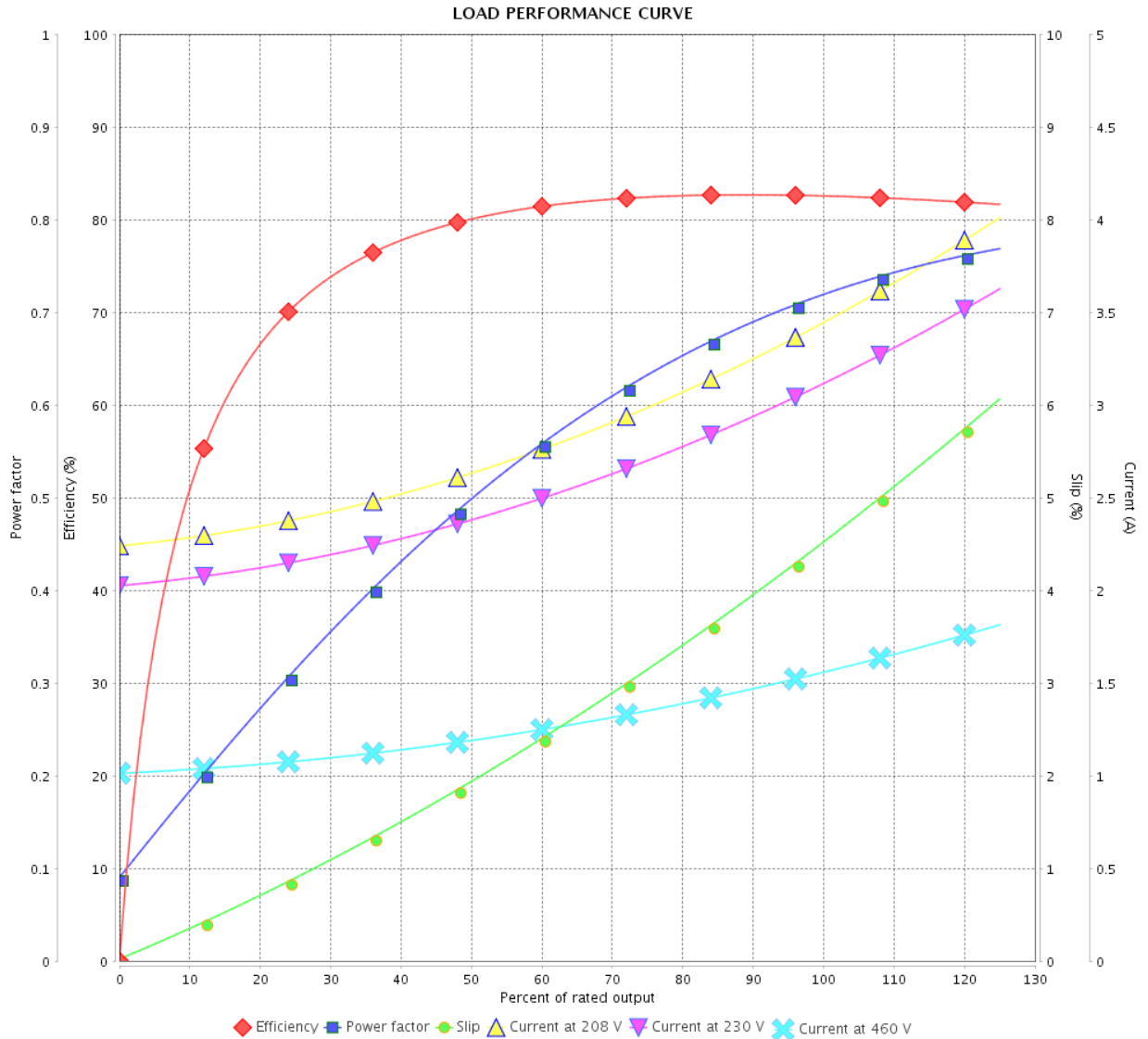

Performance : 230/460 V 60 Hz 6P

Rated current : 3.16/1.58 A
 LRC : 5.8
 Rated torque : 4.59 ft.lb
 Locked rotor torque : 229 %
 Breakdown torque : 280 %
 Rated speed : 1145 rpm

Moment of inertia (J) : 0.1597 sq.ft.lb
 Duty cycle : Cont.(S1)
 Insulation class : F
 Service factor :
 Temperature rise : 80 K
 Design : B

Rev.	Changes Summary	Performed	Checked	Date
Performed by		Page		Revision
Checked by		5 / 13		
Date		11/04/2022		

LOAD PERFORMANCE CURVE

Three Phase Induction Motor - Squirrel Cage



Customer : _____

Product line : Premium Efficiency Three-Phase Product code : 14786536
 Catalog # : 00112ET3E56CFL-S

LOAD PERFORMANCE CURVE

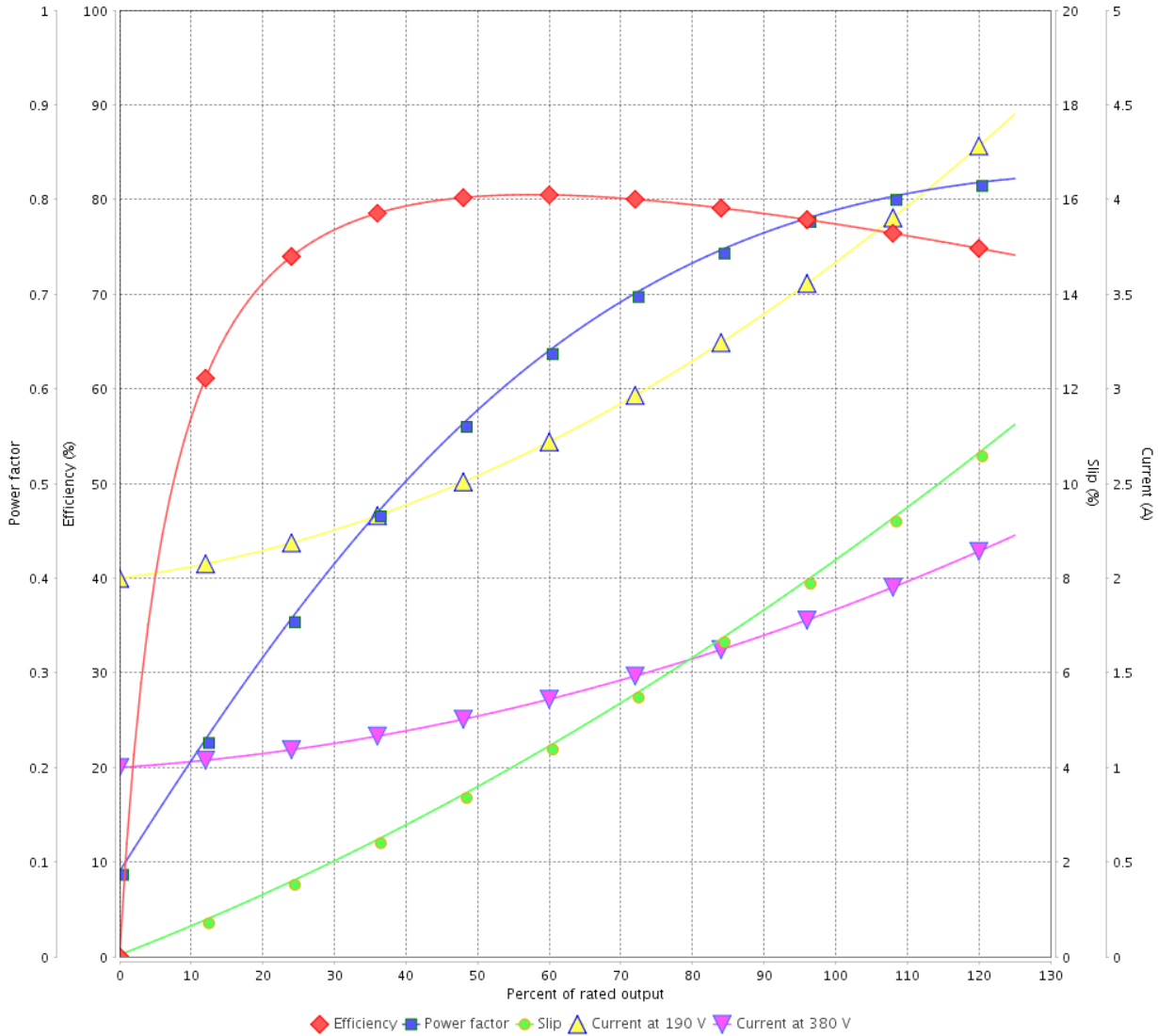

Performance : 190/380 V 50 Hz 6P

Rated current	: 3.74/1.87 A	Moment of inertia (J)	: 0.1597 sq.ft.lb
LRC	: 4.4	Duty cycle	: Cont.(S1)
Rated torque	: 5.74 ft.lb	Insulation class	: F
Locked rotor torque	: 170 %	Service factor	: 1.00
Breakdown torque	: 200 %	Temperature rise	: 105 K
Rated speed	: 915 rpm	Design	: B

Rev.	Changes Summary	Performed	Checked	Date
Performed by			Page 6 / 13	Revision
Checked by				
Date	11/04/2022			

LOAD PERFORMANCE CURVE

Three Phase Induction Motor - Squirrel Cage



Customer :

Product line : Premium Efficiency Three-Phase Product code : 14786536
 Catalog # : 00112ET3E56CFL-S

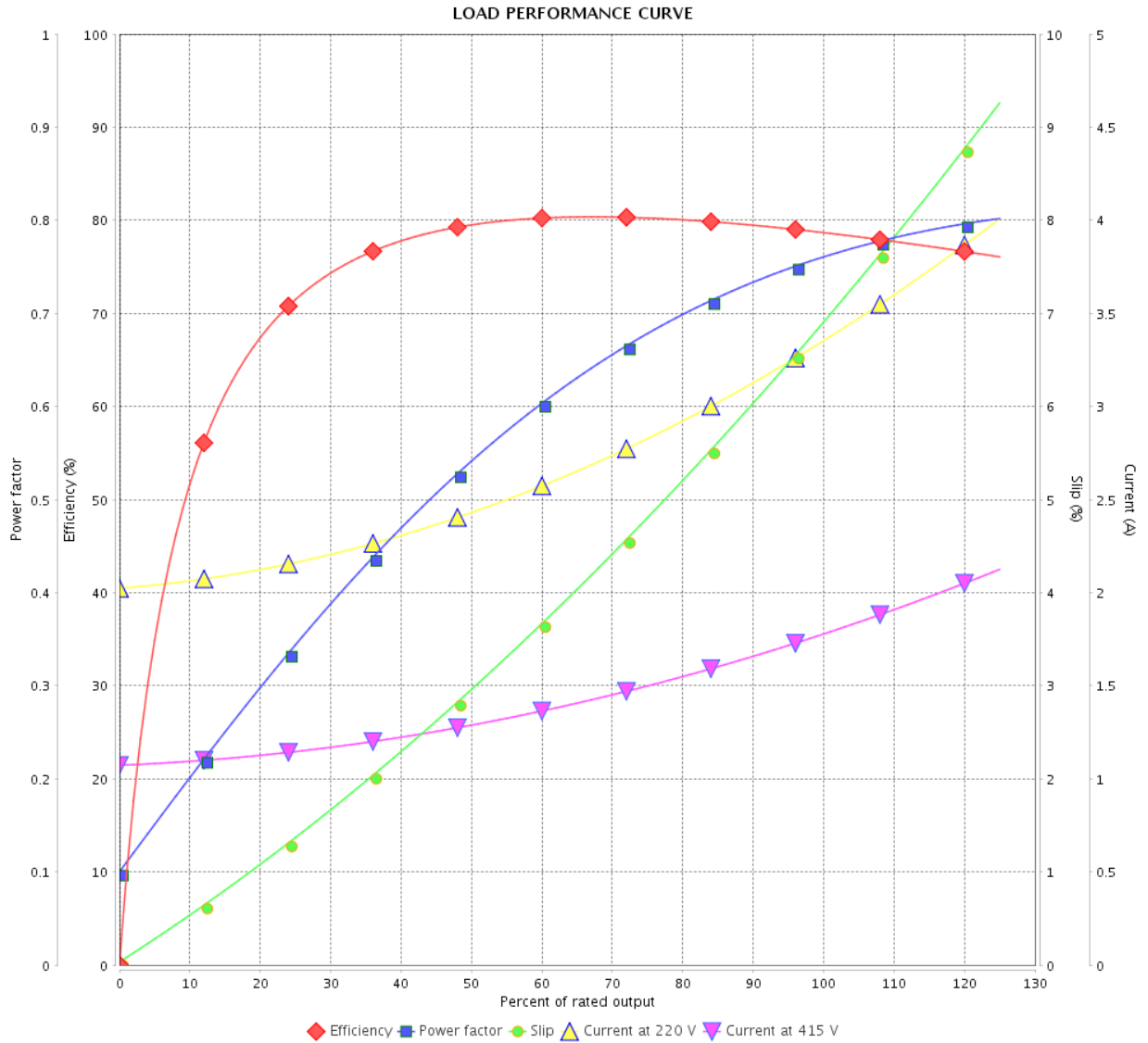

Performance : 220/415 V 50 Hz 6P

Rated current : 3.41/1.81 A
 LRC : 4.9
 Rated torque : 5.65 ft.lb
 Locked rotor torque : 200 %
 Breakdown torque : 229 %
 Rated speed : 930 rpm

Moment of inertia (J) : 0.1597 sq.ft.lb
 Duty cycle : Cont.(S1)
 Insulation class : F
 Service factor : 1.00
 Temperature rise : 105 K
 Design : B

Rev.	Changes Summary	Performed	Checked	Date
Performed by			Page 7 / 13	Revision
Checked by				
Date	11/04/2022			

THERMAL LIMIT CURVE

Three Phase Induction Motor - Squirrel Cage



Customer :

Product line : Premium Efficiency Three-Phase

Product code :

14786536

Catalog # :

00112ET3E56CFL-S

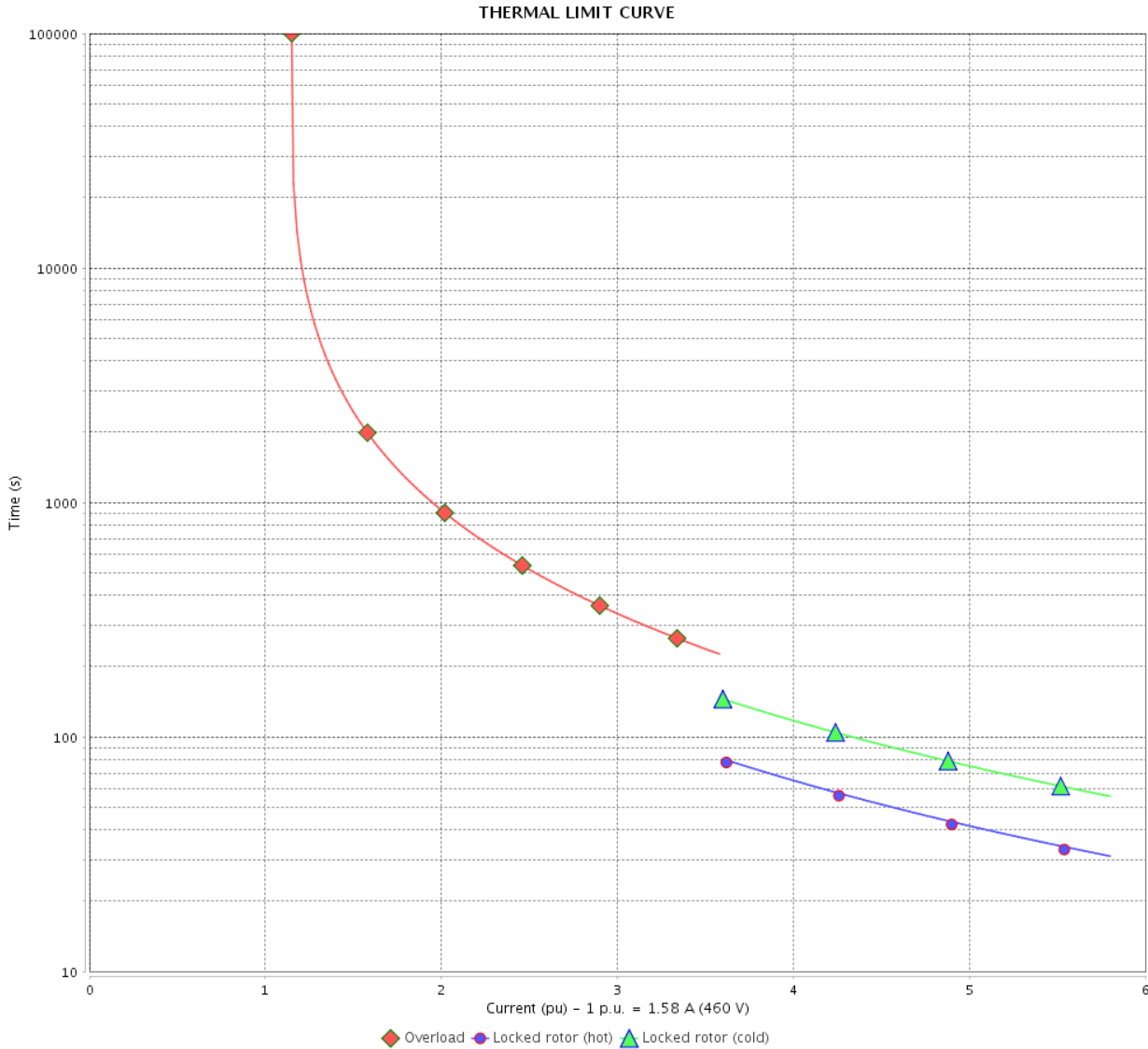

Performance : 230/460 V 60 Hz 6P

Rated current : 3.16/1.58 A
 LRC : 5.8
 Rated torque : 4.59 ft.lb
 Locked rotor torque : 229 %
 Breakdown torque : 280 %
 Rated speed : 1145 rpm

Moment of inertia (J) : 0.1597 sq.ft.lb
 Duty cycle : Cont.(S1)
 Insulation class : F
 Service factor :
 Temperature rise : 80 K
 Design : B

Heating constant

Cooling constant

Rev.	Changes Summary	Performed	Checked	Date
Performed by			Page 8 / 13	Revision
Checked by				
Date	11/04/2022			

THERMAL LIMIT CURVE

Three Phase Induction Motor - Squirrel Cage



Customer : _____

Product line : Premium Efficiency Three-Phase

Product code :

14786536

Catalog # :

00112ET3E56CFL-S

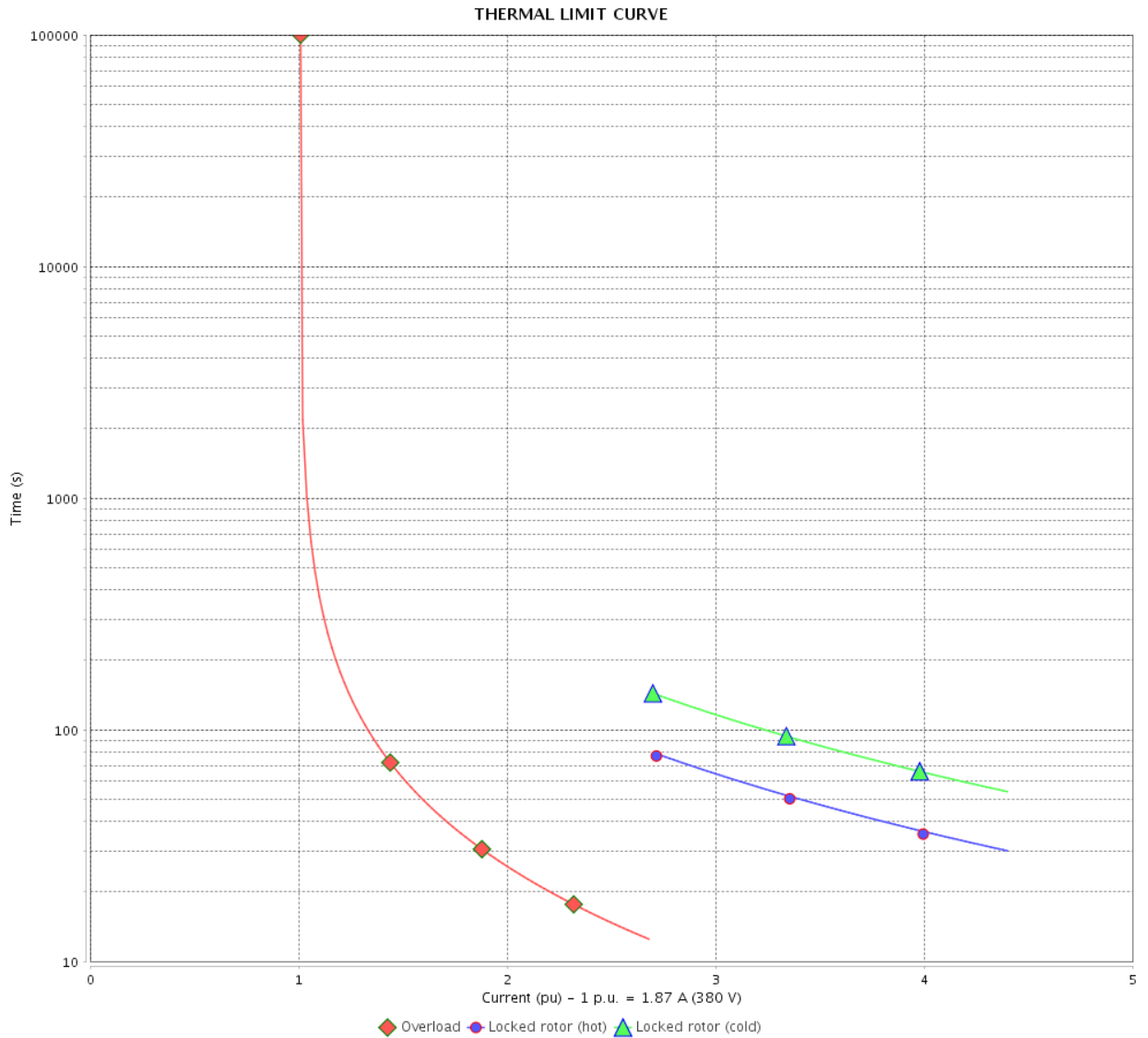

Performance : 190/380 V 50 Hz 6P

Rated current : 3.74/1.87 A
 LRC : 4.4
 Rated torque : 5.74 ft.lb
 Locked rotor torque : 170 %
 Breakdown torque : 200 %
 Rated speed : 915 rpm

Moment of inertia (J) : 0.1597 sq.ft.lb
 Duty cycle : Cont.(S1)
 Insulation class : F
 Service factor : 1.00
 Temperature rise : 105 K
 Design : B

Heating constant

Cooling constant

Rev.	Changes Summary	Performed	Checked	Date
Performed by				
Checked by				
Date				
		Page	Revision	
		9 / 13		

THERMAL LIMIT CURVE

Three Phase Induction Motor - Squirrel Cage



Customer :

Product line : Premium Efficiency Three-Phase

Product code :

14786536

Catalog # :

00112ET3E56CFL-S

THERMAL LIMIT CURVE

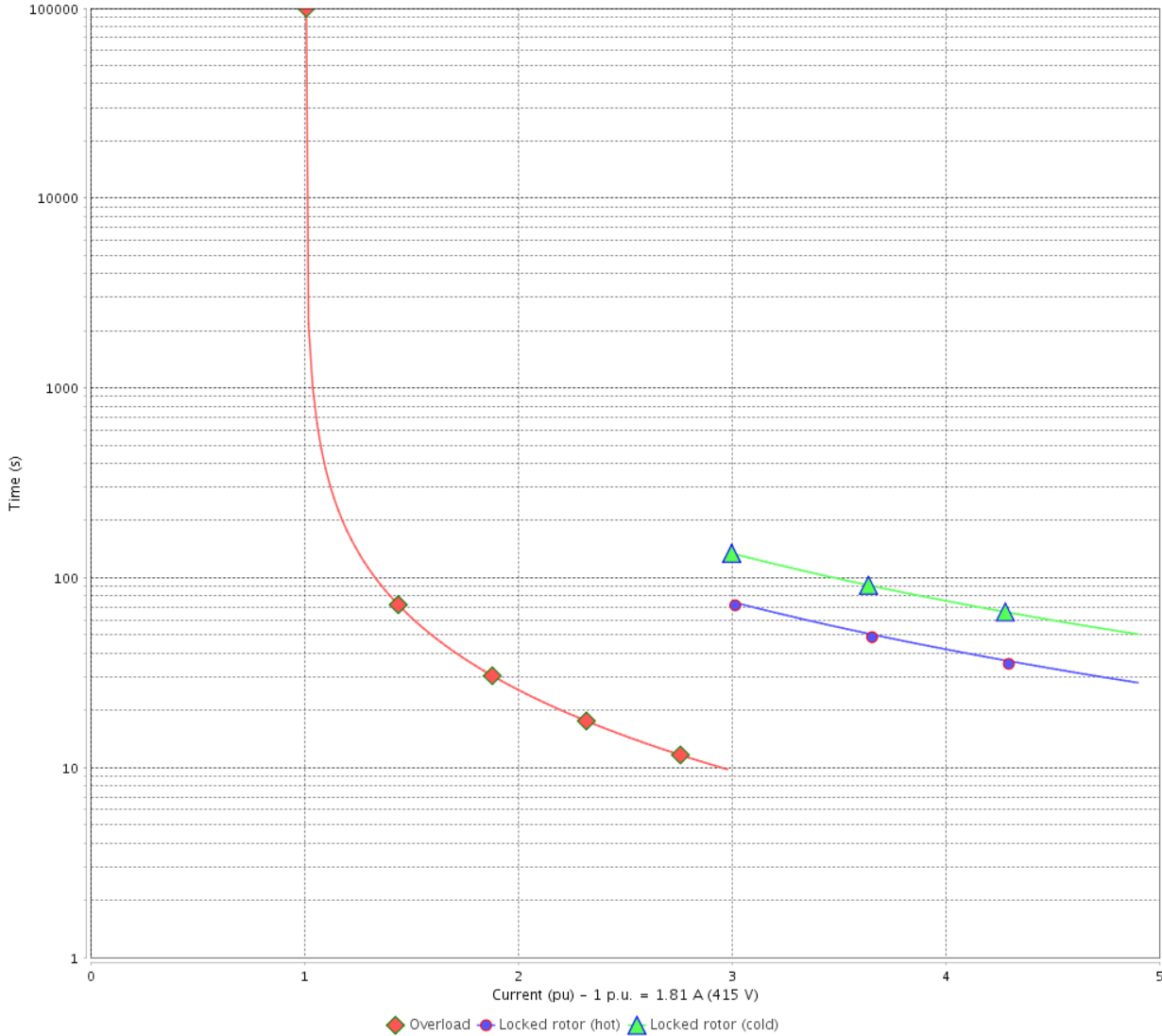

Performance : 220/415 V 50 Hz 6P

Rated current : 3.41/1.81 A
 LRC : 4.9
 Rated torque : 5.65 ft.lb
 Locked rotor torque : 200 %
 Breakdown torque : 229 %
 Rated speed : 930 rpm

Moment of inertia (J) : 0.1597 sq.ft.lb
 Duty cycle : Cont.(S1)
 Insulation class : F
 Service factor : 1.00
 Temperature rise : 105 K
 Design : B

Heating constant

Cooling constant

Rev.	Changes Summary	Performed	Checked	Date
Performed by			Page 10 / 13	Revision
Checked by				
Date	11/04/2022			

VFD OPERATION CURVE

Three Phase Induction Motor - Squirrel Cage



Customer : _____

Product line : Premium Efficiency Three-Phase Product code : 14786536
 Catalog # : 00112ET3E56CFL-S

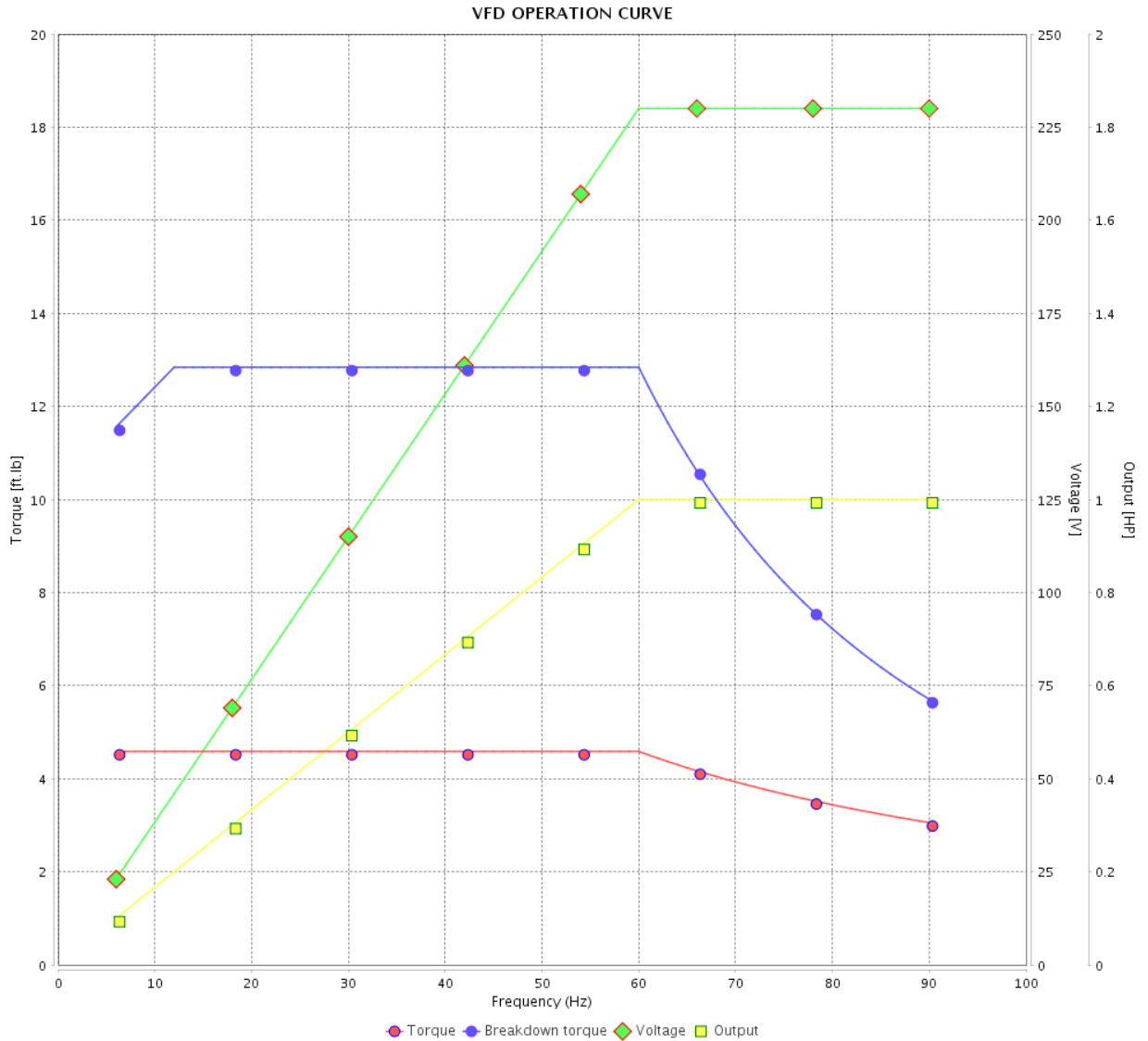

Performance : 230/460 V 60 Hz 6P

Rated current : 3.16/1.58 A
 LRC : 5.8
 Rated torque : 4.59 ft.lb
 Locked rotor torque : 229 %
 Breakdown torque : 280 %
 Rated speed : 1145 rpm

Moment of inertia (J) : 0.1597 sq.ft.lb
 Duty cycle : Cont.(S1)
 Insulation class : F
 Service factor :
 Temperature rise : 80 K
 Design : B

Rev.	Changes Summary	Performed	Checked	Date
Performed by			Page 11 / 13	Revision
Checked by				
Date	11/04/2022			

VFD OPERATION CURVE

Three Phase Induction Motor - Squirrel Cage



Customer :

Product line : Premium Efficiency Three-Phase Product code : 14786536
 Catalog # : 00112ET3E56CFL-S

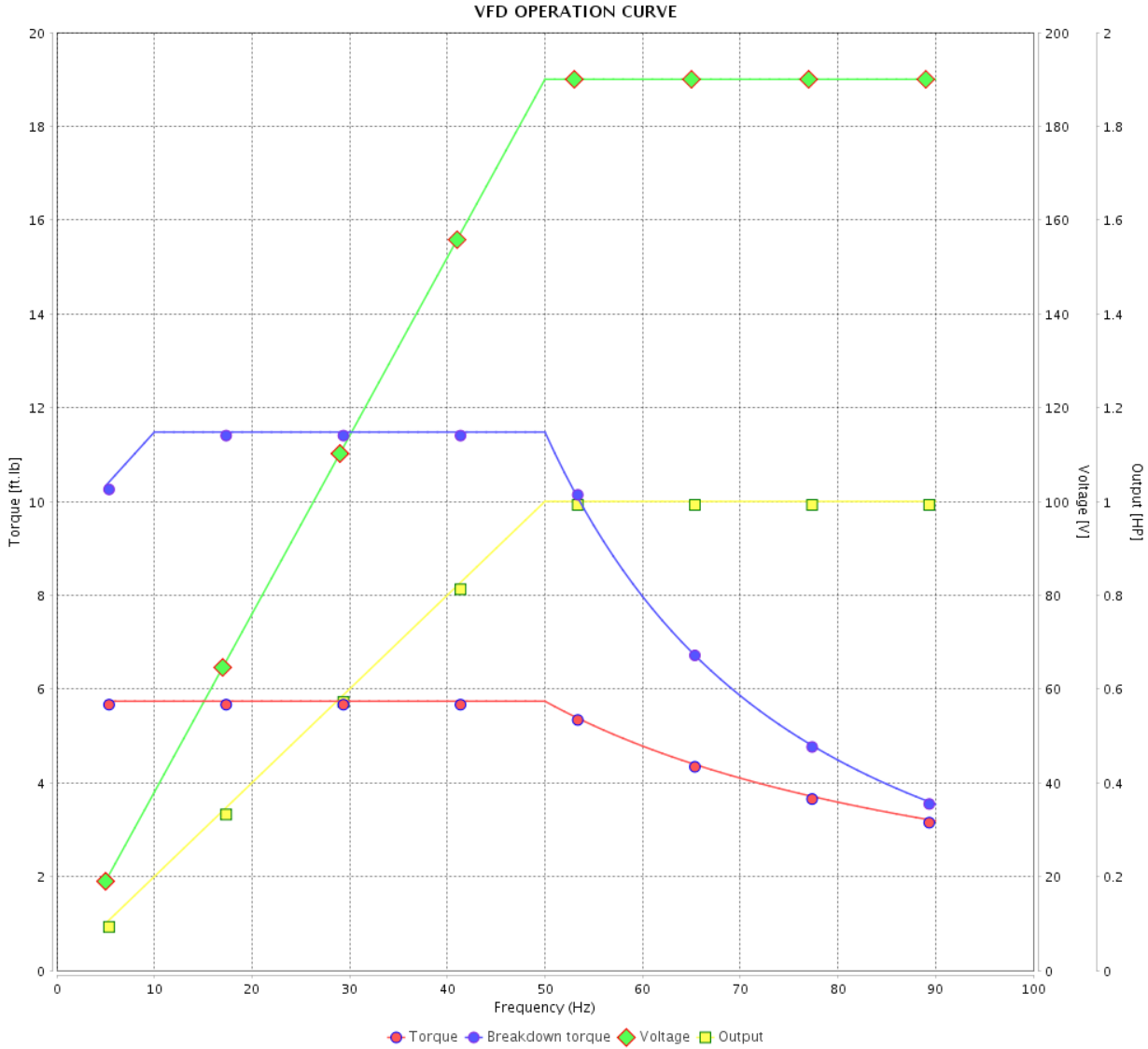

Performance : 190/380 V 50 Hz 6P

Rated current	: 3.74/1.87 A	Moment of inertia (J)	: 0.1597 sq.ft.lb
LRC	: 4.4	Duty cycle	: Cont.(S1)
Rated torque	: 5.74 ft.lb	Insulation class	: F
Locked rotor torque	: 170 %	Service factor	: 1.00
Breakdown torque	: 200 %	Temperature rise	: 105 K
Rated speed	: 915 rpm	Design	: B

Rev.	Changes Summary	Performed	Checked	Date
Performed by			Page 12 / 13	Revision
Checked by				
Date	11/04/2022			

VFD OPERATION CURVE

Three Phase Induction Motor - Squirrel Cage



Customer :

Product line : Premium Efficiency Three-Phase Product code : 14786536
 Catalog # : 00112ET3E56CFL-S

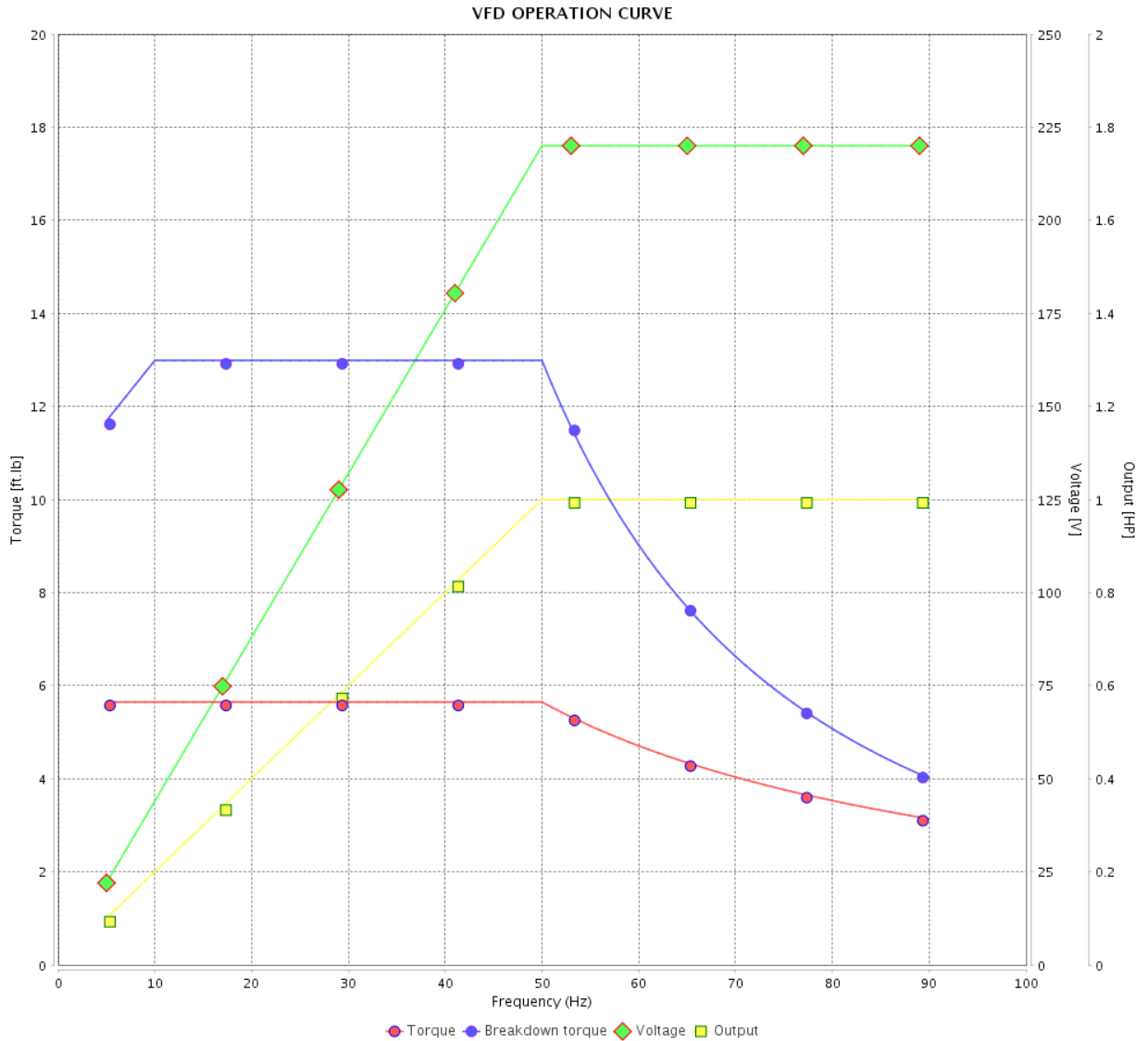

Performance : 220/415 V 50 Hz 6P

Rated current : 3.41/1.81 A
 LRC : 4.9
 Rated torque : 5.65 ft.lb
 Locked rotor torque : 200 %
 Breakdown torque : 229 %
 Rated speed : 930 rpm

Moment of inertia (J) : 0.1597 sq.ft.lb
 Duty cycle : Cont.(S1)
 Insulation class : F
 Service factor : 1.00
 Temperature rise : 105 K
 Design : B

Rev.	Changes Summary	Performed	Checked	Date
Performed by				Page 13 / 13
Checked by				
Date	11/04/2022			

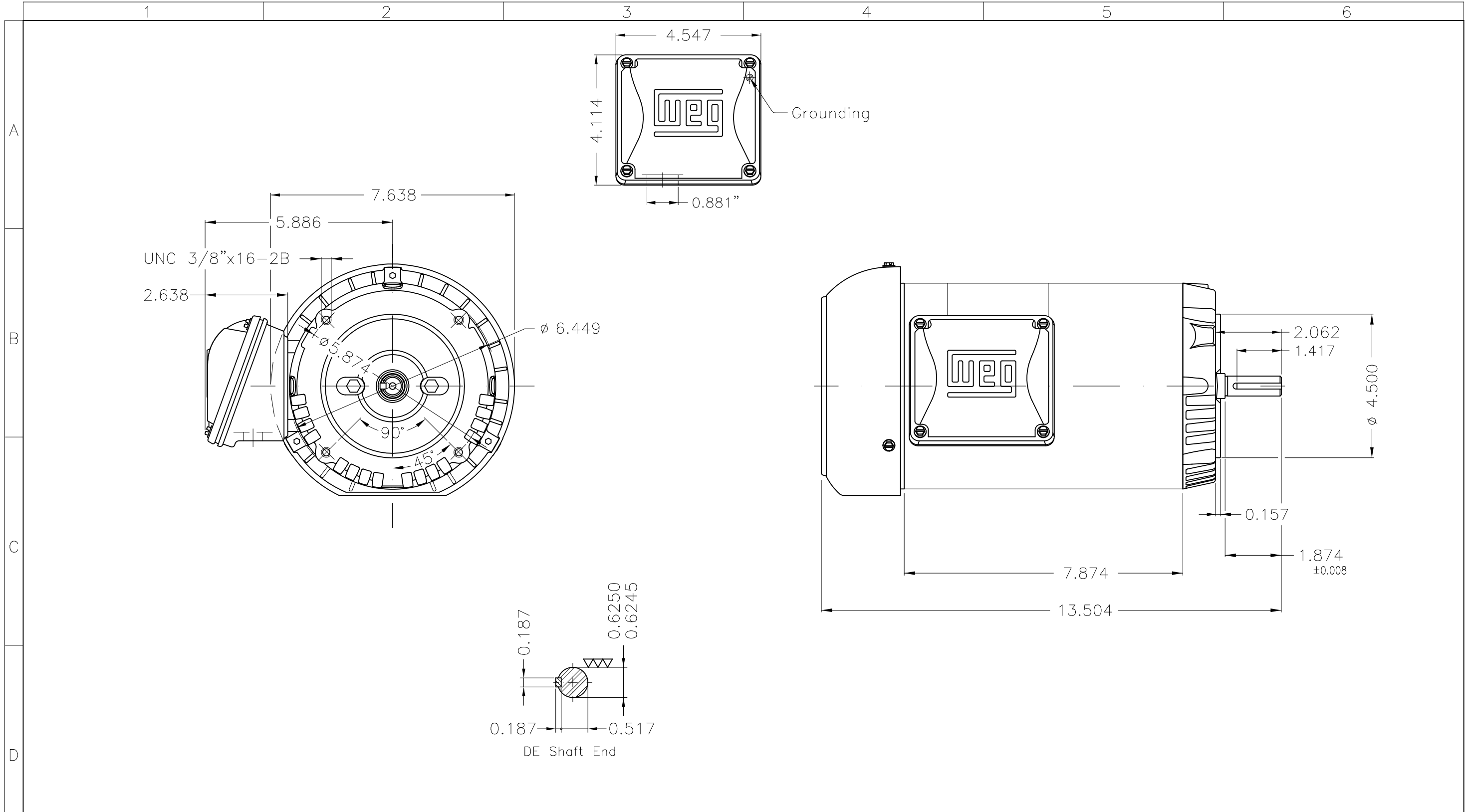

Fan cover - steel plate
 Color Munsell N 1 matte black
 Painting plan 207N
 Mounting F-1/B14R(D)

ECM	LOC	SUMMARY OF MODIFICATIONS	EXECUTED	CHECKED	RELEASED	DATE	VER
EXECUTED	PIRWBUSER	THREE PH. MOTOR ROLLED STEEL PREM. EFF.					
CHECKED		FRAME 56C IP55 TEFC					
RELEASED							
REL DT.	WMO	Jaragua do Sul	Product Engineering	SHEET	1 / 1		

1 HP 06 Poles 60 Hz

A

PREVIEW
WDD





NEMA
Premium



MADE IN BRAZIL

MAT: 14786536 CC029A
W01.TE0IC0X0X
MODEL 00112ET3E56CFL-S
30MAR2022 B/N:

For 60Hz: Class I, Zone 2, IIC
Class I, Div.2, Gr. A,B,C,D - T3
Div 2 Inverter Duty (SF1.00)
CT 2:1/VT 1000:1

PH 3	Hz 60	HP 1.0
FR 56C		KW 0.75
DUTY CONT.		V 230/460
ALT 1000 m.a.s.l.		A 3.16/1.58
INS CL F AT 80K	IP55	SFA 3.63/1.82
AMB 40°C	DES B	SF 1.15
ENCL TEFC	CODE J	PF 0.72
USABLE @ 208V 3.50A		RPM 1145
SF1.00		NEMA NOM. EFF 82.5%

ALTERNATE RATING: 1.0HP 50Hz 190-220/380-415V SF1.00
3.74-3.36/1.87-1.78A 915RPM EFF 77.3% (IE2) IEC 60034-1

For safe area-inverter duty motor For 60Hz use on VPWM 1000:1 VT, 5:1 CT

DE 6204-ZZ ODE 6202-ZZ MOBIL POLYREX EM



T1-BLU T2-WHT
T3-ORG T4-YEL
T5-BLK T6-GRY
T7-PNK T8-RED
T9-BRK RED

INTERCHANGE ANY TWO LINE WIRES TO REVERSE THE ROTATION

WARNING: Motor must be grounded in accordance with local and national electrical codes to prevent serious electrical shocks. Disconnect power source before servicing unit.



AVERTISSEMENT: Le moteur doit être mis à la terre conformément aux codes électriques locaux et nationaux afin d'éviter tout choc électrique grave. Déconnectez l'alimentation avant l'entretien de la machine.

