

DATA SHEET



Three Phase Induction Motor - Squirrel Cage

Customer :								
Product line	: NEMA Premium Efficiency Three-Phase	Product code :	12821872					
		Catalog # :	00112ET3ER145TC-W22					
Frame	: 145TC	Cooling method	: IC411 - TEFC					
Insulation class	: F	Mounting	: W-6					
Duty cycle	: Cont.(S1)	Rotation ¹	: Both (CW and CCW)					
Ambient temperature	: -20°C to +40°C	Starting method	: Direct On Line					
Altitude	: 1000 m.a.s.l.	Approx. weight ²	: 52.1 lb					
Protection degree	: IP55	Moment of inertia (J)	: 0.1595 sq.ft.lb					
Design	: B							
Output [HP]	1	0.75	0.75	0.75	1	1	1	
Poles	6	6	6	6	6	6	6	
Frequency [Hz]	60	50	50	50	50	50	50	
Rated voltage [V]	230/460	380	400	415	380	400	415	
Rated current [A]	3.46/1.73	1.60	1.62	1.66	1.96	1.94	1.95	
L. R. Amperes [A]	21.5/10.7	9.28	9.88	10.5	9.41	10.1	10.7	
LRC [A]	6.2x(Code K)	5.8x(Code K)	6.1x(Code L)	6.3x(Code M)	4.8x(Code G)	5.2x(Code H)	5.5x(Code J)	
No load current [A]	2.39/1.20	1.18	1.28	1.36	1.18	1.28	1.36	
Rated speed [RPM]	1160	960	970	970	940	950	950	
Slip [%]	3.33	4.00	3.00	3.00	6.00	5.00	5.00	
Rated torque [ft.lb]	4.53	4.10	4.06	4.06	5.59	5.53	5.53	
Locked rotor torque [%]	260	280	300	320	200	229	250	
Breakdown torque [%]	300	310	330	340	220	260	280	
Service factor	1.25	1.00	1.00	1.00	1.00	1.00	1.00	
Temperature rise	80 K	80 K	80 K	80 K	80 K	80 K	80 K	
Locked rotor time	50s (cold) 28s (hot)	36s (cold) 20s (hot)	36s (cold) 20s (hot)	36s (cold) 20s (hot)	36s (cold) 20s (hot)	36s (cold) 20s (hot)	36s (cold) 20s (hot)	
Noise level ²	50.0 dB(A)	45.0 dB(A)	45.0 dB(A)	45.0 dB(A)	45.0 dB(A)	45.0 dB(A)	45.0 dB(A)	
Efficiency (%)	25%	76.0	73.6	71.6	68.6	77.6	76.1	73.4
	50%	77.0	74.8	73.2	70.7	77.0	75.5	74.0
	75%	82.0	78.4	77.5	75.8	80.0	80.0	78.5
	100%	82.5	79.3	78.9	77.9	78.5	78.5	78.5
Power Factor	25%	0.25	0.24	0.22	0.21	0.30	0.27	0.25
	50%	0.45	0.44	0.41	0.38	0.53	0.49	0.46
	75%	0.57	0.57	0.53	0.50	0.66	0.62	0.59
	100%	0.66	0.66	0.62	0.59	0.74	0.71	0.68
Bearing type	: Drive end : 6205 ZZ	Non drive end : 6204 ZZ	Foundation loads					
Sealing	: V'Ring	V'Ring	Max. traction	: 108 lb				
Lubrication interval	: -	-	Max. compression	: 161 lb				
Lubricant amount	: -	-						
Lubricant type	: Mobil Polyrex EM							
Notes								
USABLE @208V 3.82A SF 1.15 SFA 4.39A								
This revision replaces and cancel the previous one, which must be eliminated. (1) Looking the motor from the shaft end. (2) Measured at 1m and with tolerance of +3dB(A). (3) Approximate weight subject to changes after manufacturing process. (4) At 100% of full load.				These are average values based on tests with sinusoidal power supply, subject to the tolerances stipulated in NEMA MG-1.				
Rev.	Changes Summary			Performed	Checked	Date		
Performed by								
Checked by					Page	Revision		
Date	11/04/2022				1 / 36			

TORQUE AND CURRENT VS SPEED CURVE



Three Phase Induction Motor - Squirrel Cage

Customer :

Product line : NEMA Premium Efficiency Three-Phase

Product code : 12821872

Catalog # : 00112ET3ER145TC-W22

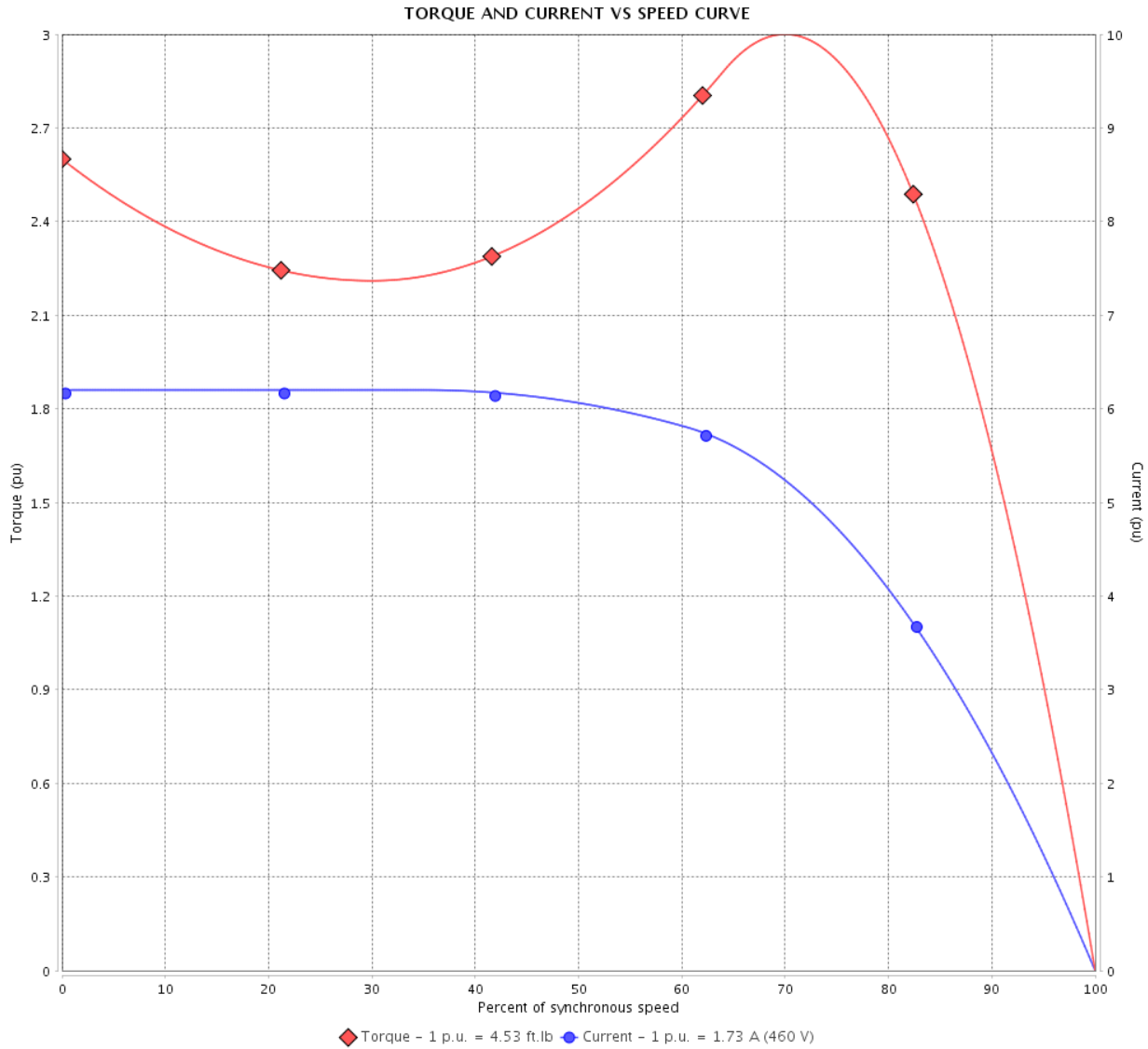

Performance : 230/460 V 60 Hz 6P

Rated current	: 3.46/1.73 A	Moment of inertia (J)	: 0.1595 sq.ft.lb
LRC	: 6.2	Duty cycle	: Cont.(S1)
Rated torque	: 4.53 ft.lb	Insulation class	: F
Locked rotor torque	: 260 %	Service factor	: 1.25
Breakdown torque	: 300 %	Temperature rise	: 80 K
Rated speed	: 1160 rpm	Design	: B

Locked rotor time : 50s (cold) 28s (hot)

Rev.	Changes Summary	Performed	Checked	Date
Performed by			Page 2 / 36	Revision
Checked by				
Date	11/04/2022			

TORQUE AND CURRENT VS SPEED CURVE



Three Phase Induction Motor - Squirrel Cage

Customer :

Product line : NEMA Premium Efficiency Three-Phase

Product code : 12821872

Catalog # : 00112ET3ER145TC-W22

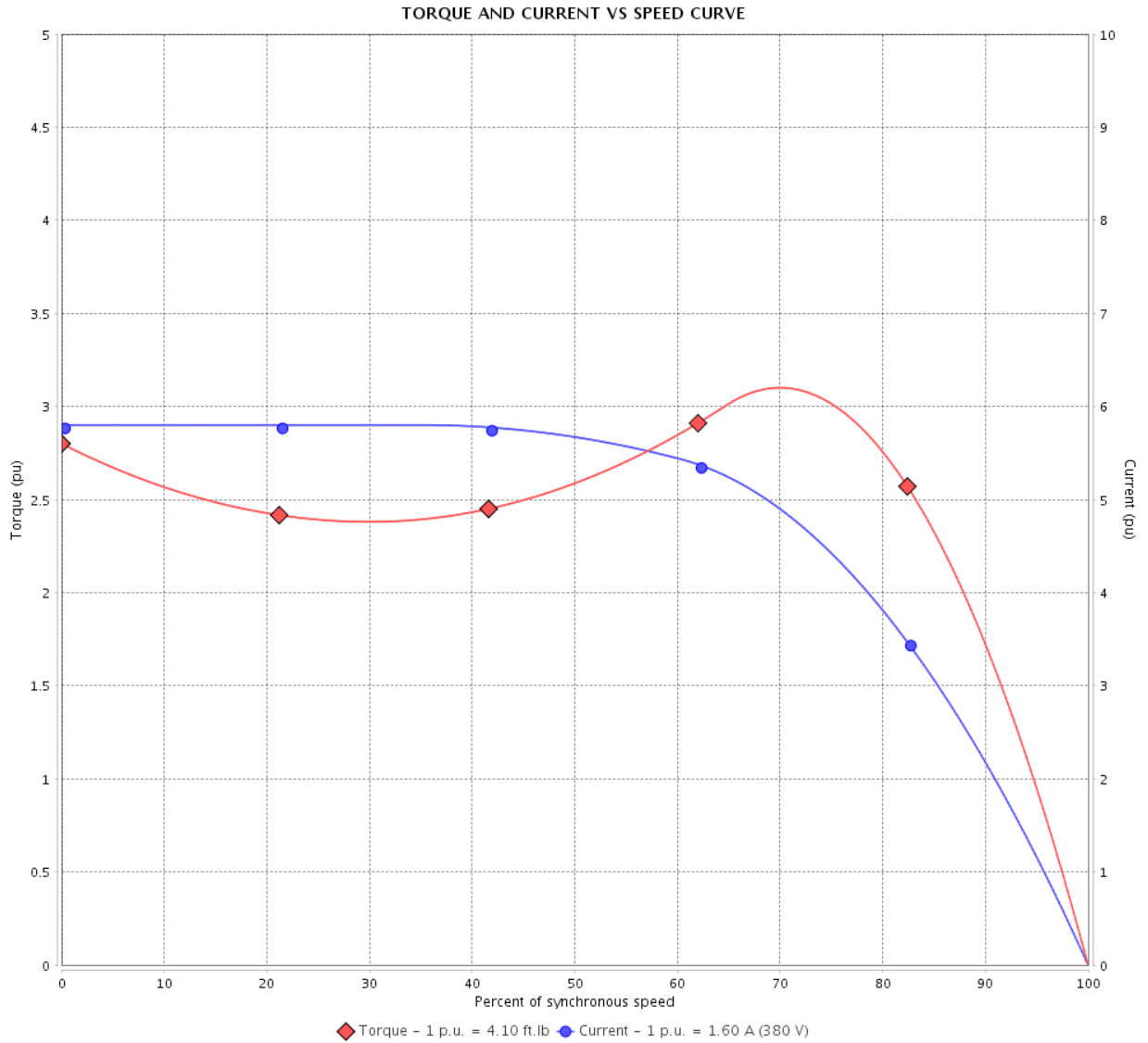

Performance : 380 V 50 Hz 6P IE3

Rated current	: 1.60 A	Moment of inertia (J)	: 0.1595 sq.ft.lb
LRC	: 5.8	Duty cycle	: Cont.(S1)
Rated torque	: 4.10 ft.lb	Insulation class	: F
Locked rotor torque	: 280 %	Service factor	: 1.00
Breakdown torque	: 310 %	Temperature rise	: 80 K
Rated speed	: 960 rpm	Design	: B

Locked rotor time : 36s (cold) 20s (hot)

Rev.	Changes Summary	Performed	Checked	Date
Performed by		Page		Revision
Checked by		3 / 36		
Date	11/04/2022			

TORQUE AND CURRENT VS SPEED CURVE

Three Phase Induction Motor - Squirrel Cage



Customer :

Product line : NEMA Premium Efficiency Three-Phase

Product code : 12821872

Catalog # : 00112ET3ER145TC-W22

TORQUE AND CURRENT VS SPEED CURVE

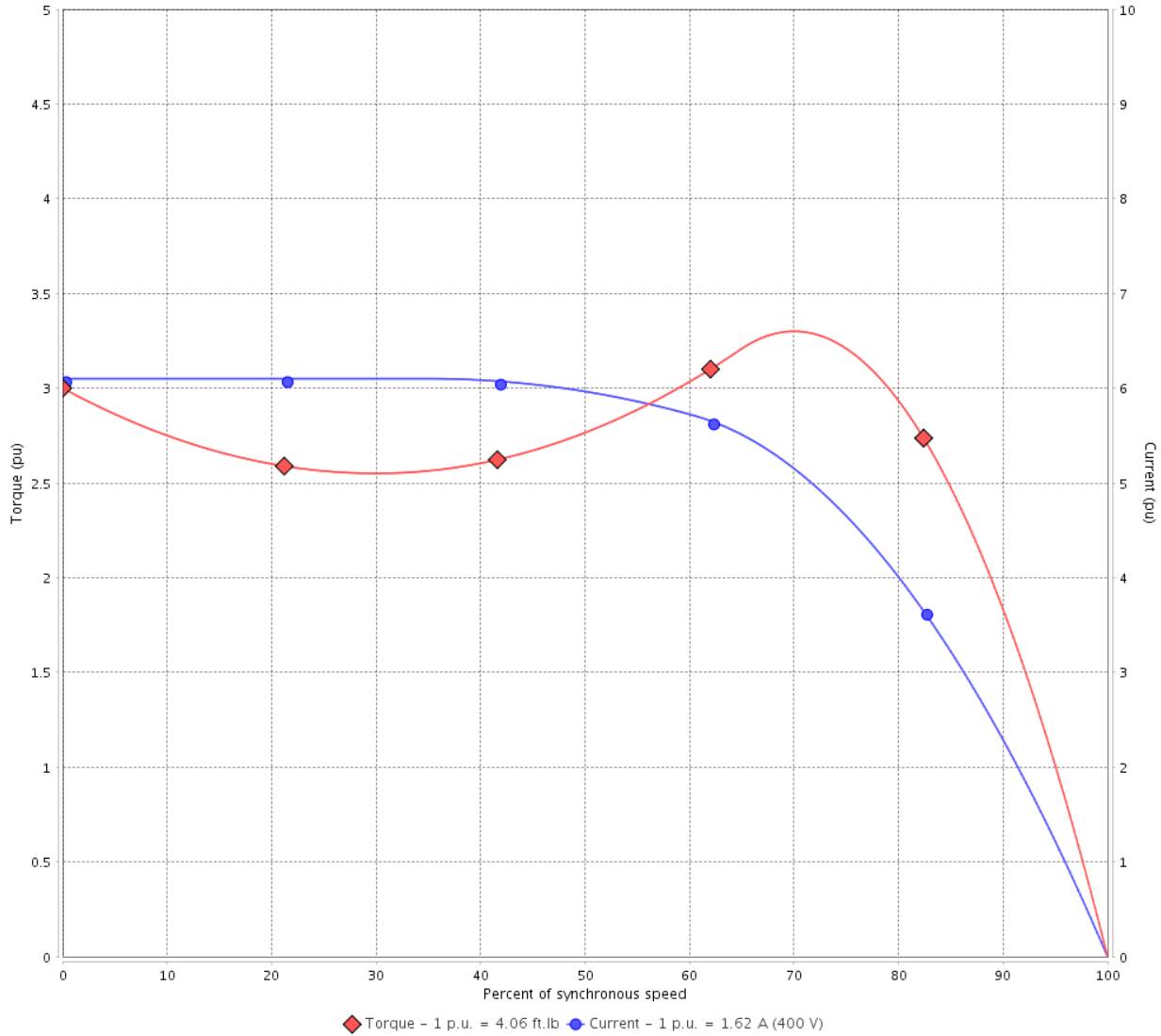

Performance : 400 V 50 Hz 6P IE3

Rated current	: 1.62 A	Moment of inertia (J)	: 0.1595 sq.ft.lb
LRC	: 6.1	Duty cycle	: Cont.(S1)
Rated torque	: 4.06 ft.lb	Insulation class	: F
Locked rotor torque	: 300 %	Service factor	: 1.00
Breakdown torque	: 330 %	Temperature rise	: 80 K
Rated speed	: 970 rpm	Design	: B

Locked rotor time : 36s (cold) 20s (hot)

Rev.	Changes Summary	Performed	Checked	Date
Performed by			Page 4 / 36	Revision
Checked by				
Date	11/04/2022			

TORQUE AND CURRENT VS SPEED CURVE



Three Phase Induction Motor - Squirrel Cage

Customer :

Product line : NEMA Premium Efficiency Three-Phase Product code : 12821872
 Catalog # : 00112ET3ER145TC-W22

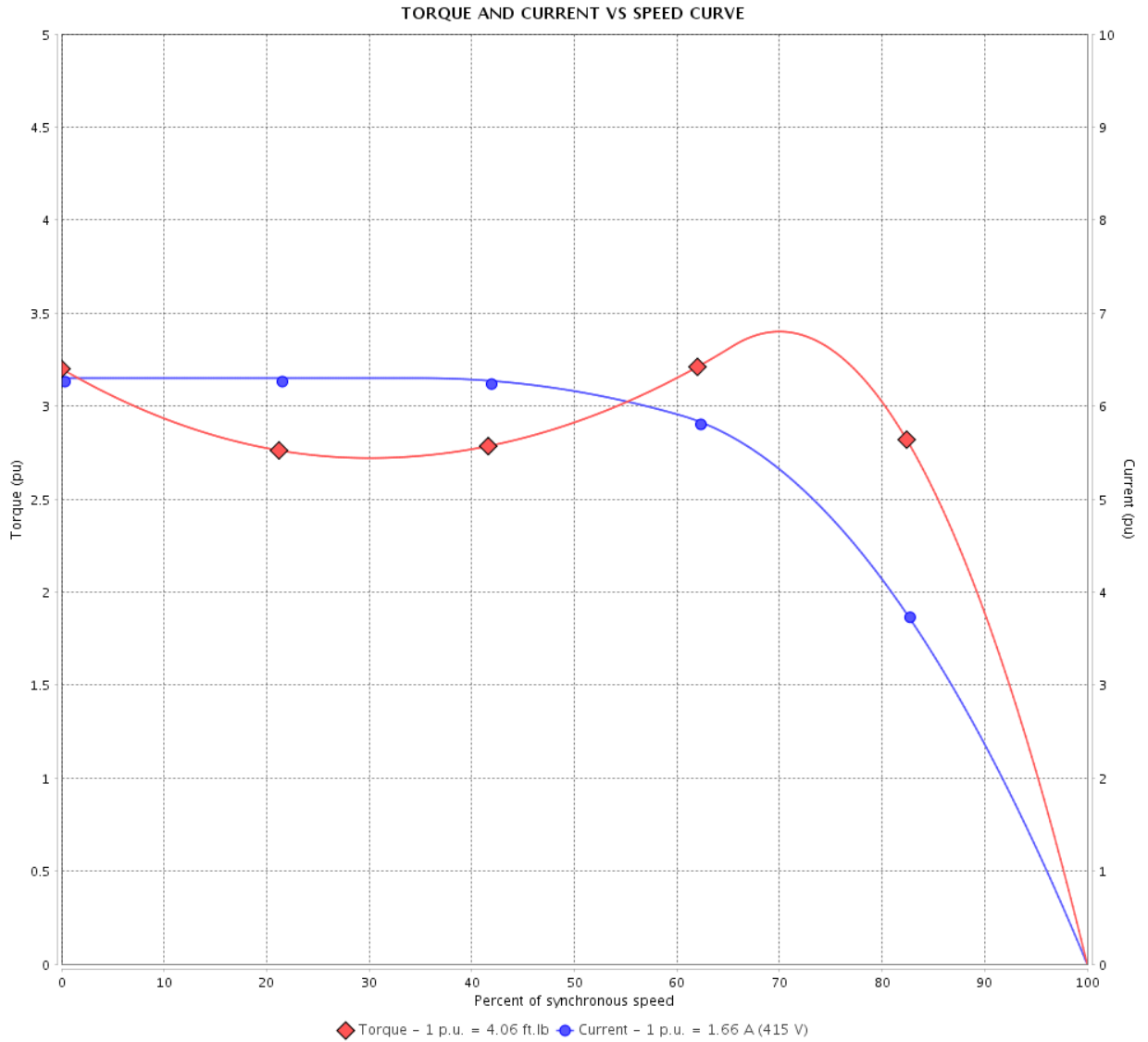

Performance : 415 V 50 Hz 6P IE3

Rated current	: 1.66 A	Moment of inertia (J)	: 0.1595 sq.ft.lb
LRC	: 6.3	Duty cycle	: Cont.(S1)
Rated torque	: 4.06 ft.lb	Insulation class	: F
Locked rotor torque	: 320 %	Service factor	: 1.00
Breakdown torque	: 340 %	Temperature rise	: 80 K
Rated speed	: 970 rpm	Design	: B

Locked rotor time : 36s (cold) 20s (hot)

Rev.	Changes Summary	Performed	Checked	Date
Performed by			Page 5 / 36	Revision
Checked by				
Date	11/04/2022			

TORQUE AND CURRENT VS SPEED CURVE

Three Phase Induction Motor - Squirrel Cage



Customer :

Product line : NEMA Premium Efficiency Three-Phase

Product code : 12821872

Catalog # : 00112ET3ER145TC-W22

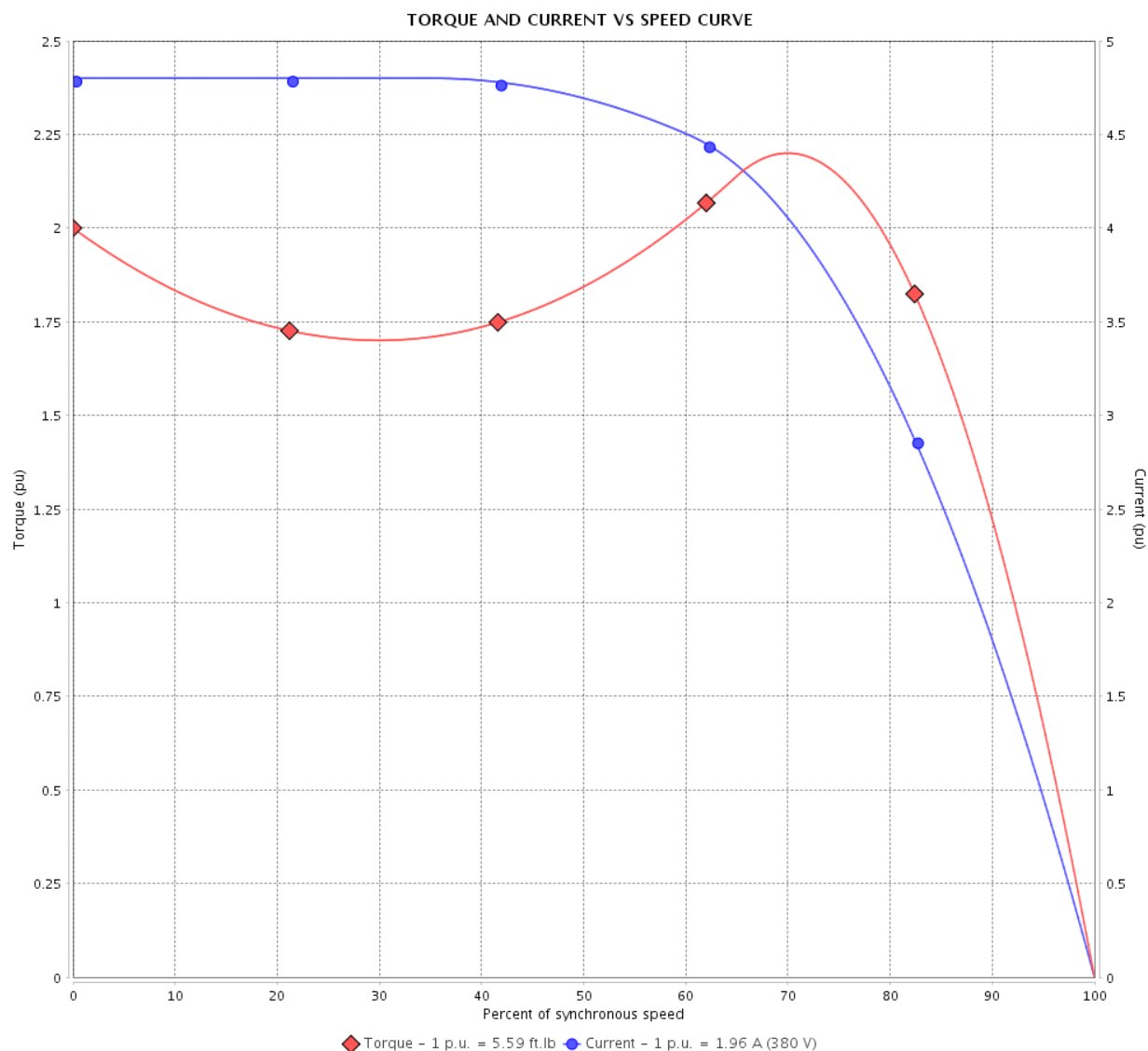

Performance : 380 V 50 Hz 6P IE2

Rated current	: 1.96 A	Moment of inertia (J)	: 0.1595 sq.ft.lb
LRC	: 4.8	Duty cycle	: Cont.(S1)
Rated torque	: 5.59 ft.lb	Insulation class	: F
Locked rotor torque	: 200 %	Service factor	: 1.00
Breakdown torque	: 220 %	Temperature rise	: 80 K
Rated speed	: 940 rpm	Design	: B

Locked rotor time : 36s (cold) 20s (hot)

Rev.	Changes Summary	Performed	Checked	Date
Performed by			Page 6 / 36	Revision
Checked by				
Date	11/04/2022			

TORQUE AND CURRENT VS SPEED CURVE



Three Phase Induction Motor - Squirrel Cage

Customer :

Product line : NEMA Premium Efficiency Three-Phase
 Product code : 12821872
 Catalog # : 00112ET3ER145TC-W22

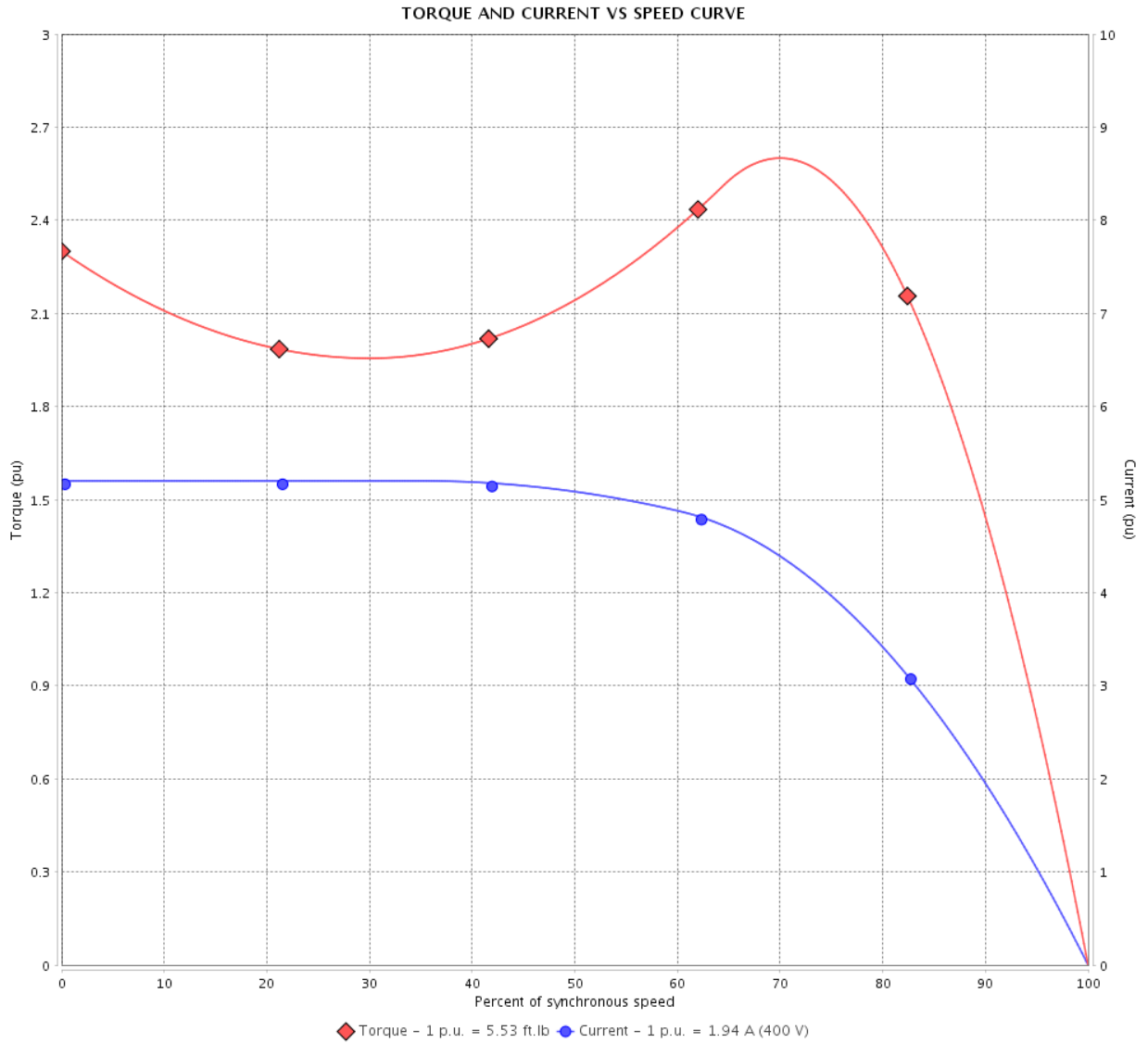

Performance : 400 V 50 Hz 6P IE2

Rated current	: 1.94 A	Moment of inertia (J)	: 0.1595 sq.ft.lb
LRC	: 5.2	Duty cycle	: Cont.(S1)
Rated torque	: 5.53 ft.lb	Insulation class	: F
Locked rotor torque	: 229 %	Service factor	: 1.00
Breakdown torque	: 260 %	Temperature rise	: 80 K
Rated speed	: 950 rpm	Design	: B

Locked rotor time : 36s (cold) 20s (hot)

Rev.	Changes Summary	Performed	Checked	Date
Performed by			Page	Revision
Checked by			7 / 36	
Date	11/04/2022			

TORQUE AND CURRENT VS SPEED CURVE

Three Phase Induction Motor - Squirrel Cage



Customer :

Product line : NEMA Premium Efficiency Three-Phase

Product code : 12821872

Catalog # : 00112ET3ER145TC-W22

TORQUE AND CURRENT VS SPEED CURVE

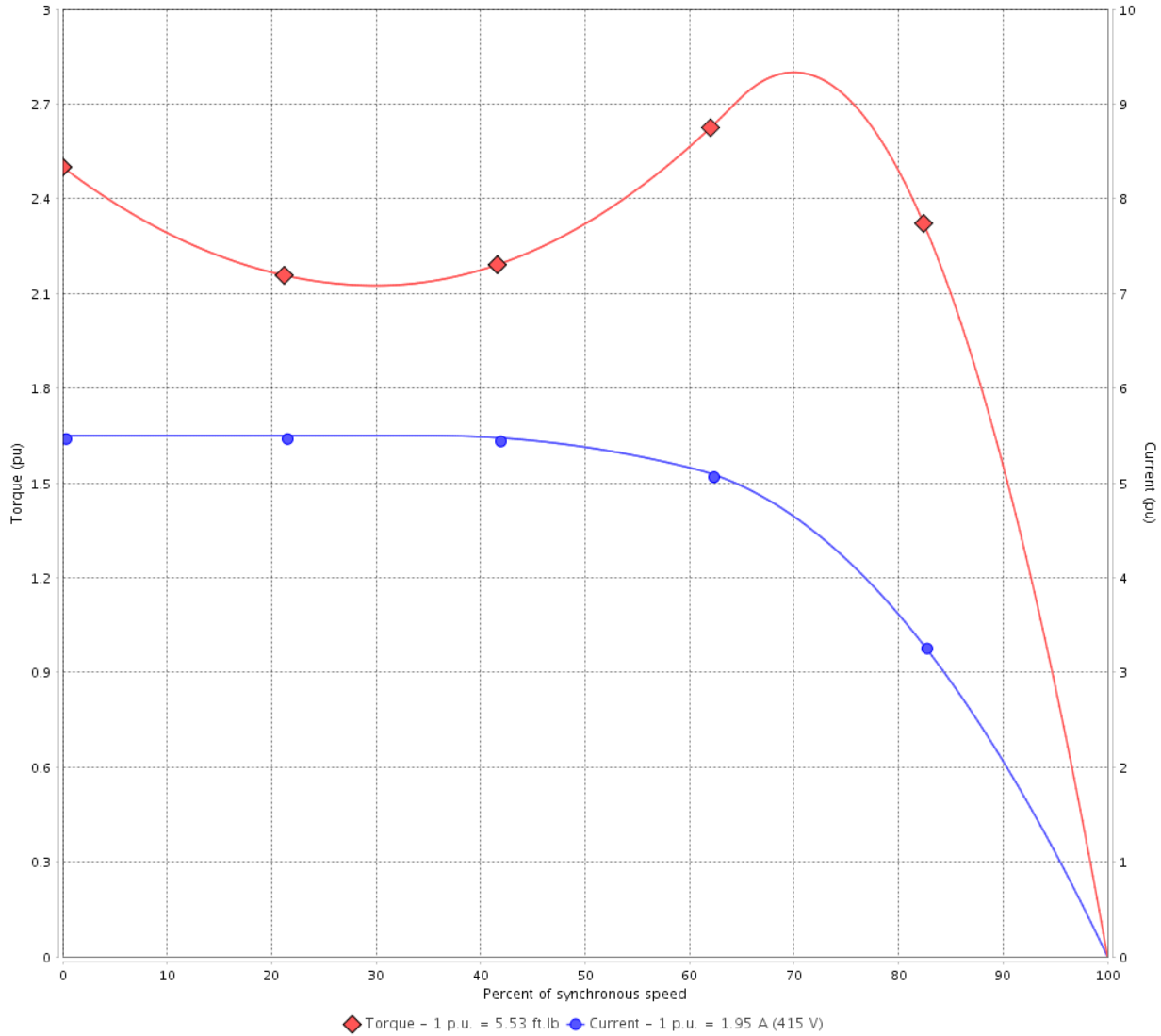

Performance : 415 V 50 Hz 6P IE2

Rated current	: 1.95 A	Moment of inertia (J)	: 0.1595 sq.ft.lb
LRC	: 5.5	Duty cycle	: Cont.(S1)
Rated torque	: 5.53 ft.lb	Insulation class	: F
Locked rotor torque	: 250 %	Service factor	: 1.00
Breakdown torque	: 280 %	Temperature rise	: 80 K
Rated speed	: 950 rpm	Design	: B

Locked rotor time : 36s (cold) 20s (hot)

Rev.	Changes Summary	Performed	Checked	Date
Performed by			Page 8 / 36	Revision
Checked by				
Date	11/04/2022			

LOAD PERFORMANCE CURVE

Three Phase Induction Motor - Squirrel Cage



Customer :

Product line : NEMA Premium Efficiency Three-Phase

Product code : 12821872

Catalog # : 00112ET3ER145TC-W22

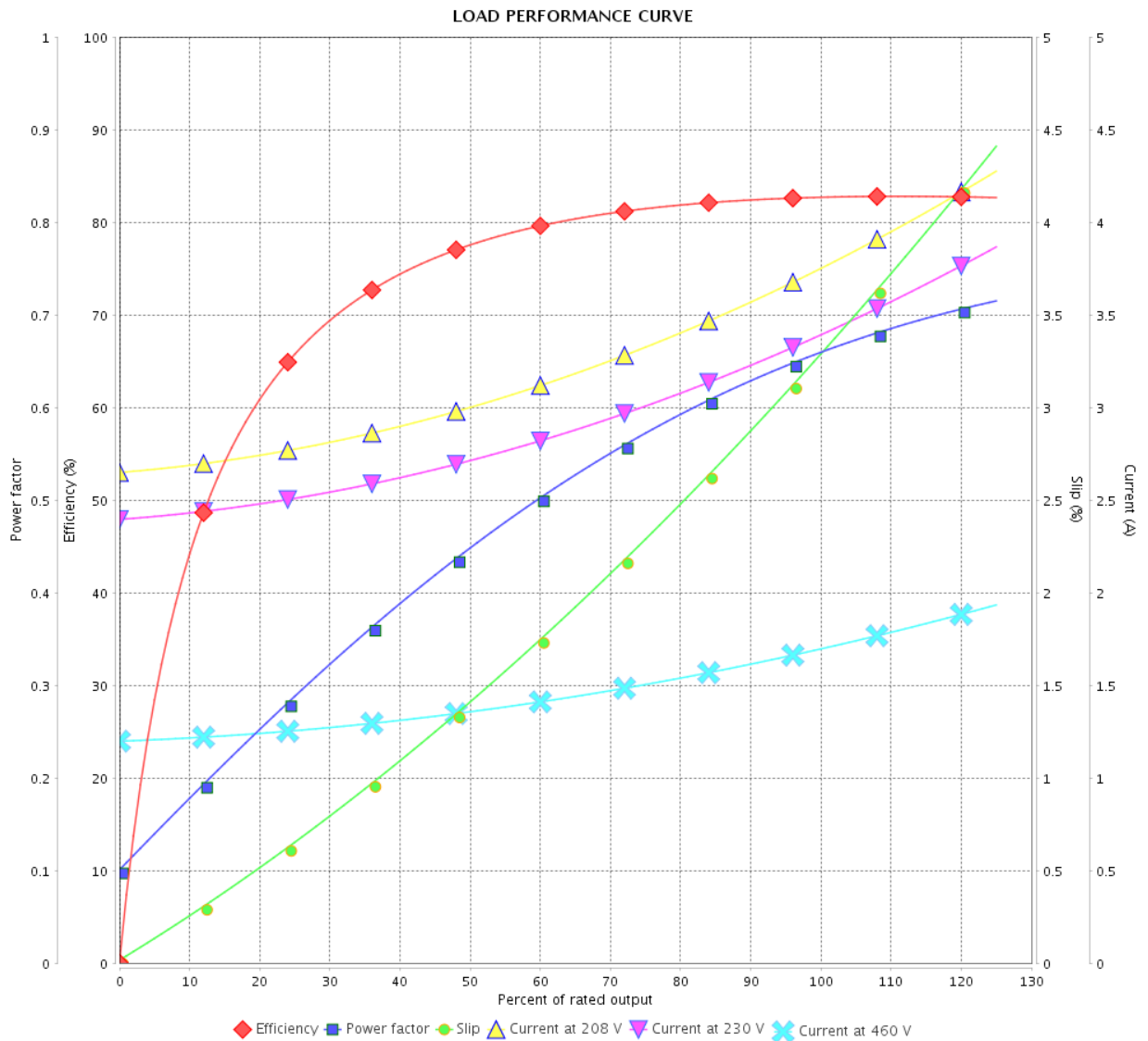

Performance : 230/460 V 60 Hz 6P

Rated current : 3.46/1.73 A
 LRC : 6.2
 Rated torque : 4.53 ft.lb
 Locked rotor torque : 260 %
 Breakdown torque : 300 %
 Rated speed : 1160 rpm

Moment of inertia (J) : 0.1595 sq.ft.lb
 Duty cycle : Cont.(S1)
 Insulation class : F
 Service factor : 1.25
 Temperature rise : 80 K
 Design : B

Rev.	Changes Summary	Performed	Checked	Date
Performed by		Page		Revision
Checked by		9 / 36		
Date		11/04/2022		

LOAD PERFORMANCE CURVE

Three Phase Induction Motor - Squirrel Cage



Customer :

Product line : NEMA Premium Efficiency Three-Phase

Product code : 12821872

Catalog # : 00112ET3ER145TC-W22

LOAD PERFORMANCE CURVE

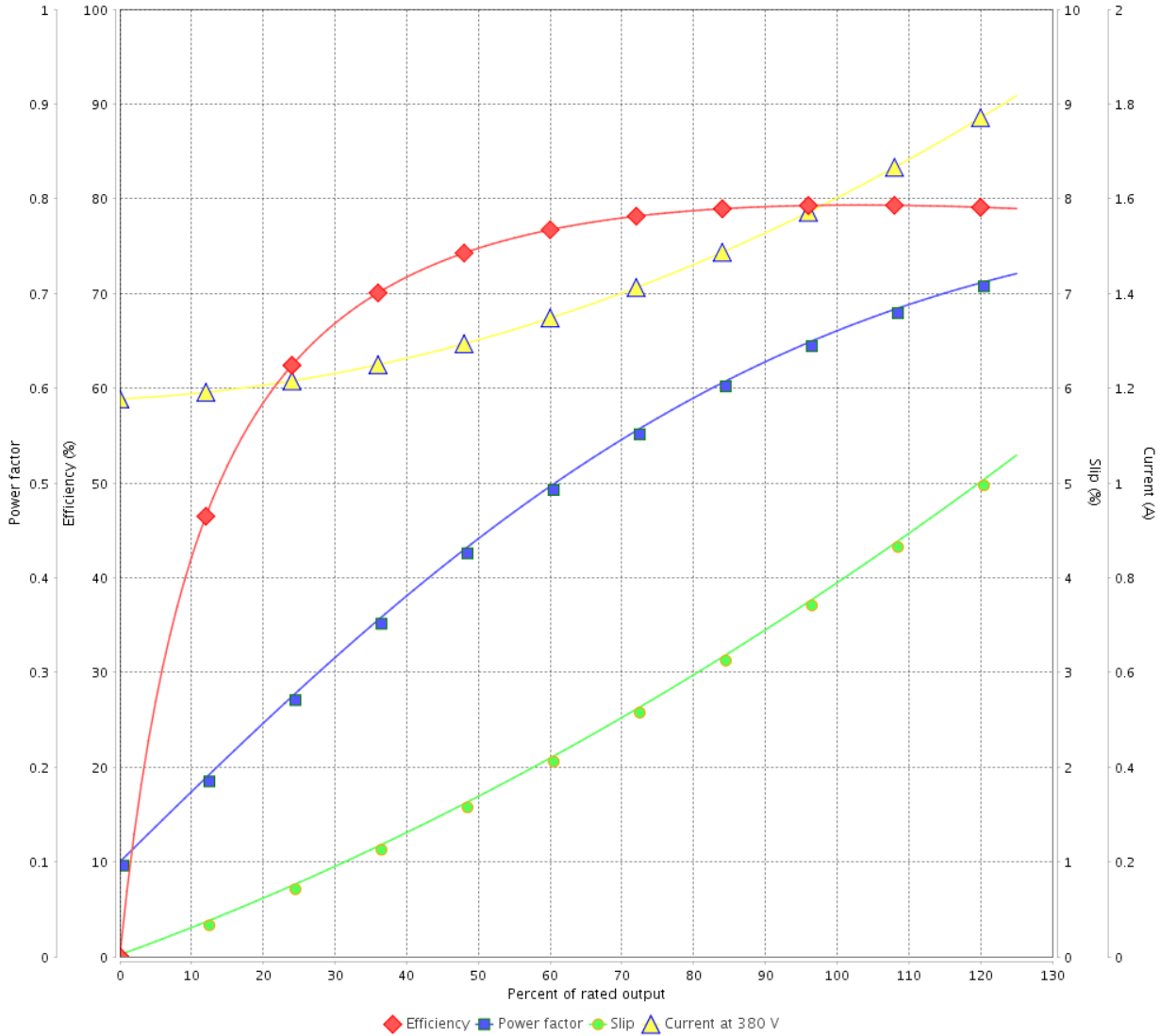

Performance : 380 V 50 Hz 6P IE3

Rated current : 1.60 A
 LRC : 5.8
 Rated torque : 4.10 ft.lb
 Locked rotor torque : 280 %
 Breakdown torque : 310 %
 Rated speed : 960 rpm

Moment of inertia (J) : 0.1595 sq.ft.lb
 Duty cycle : Cont.(S1)
 Insulation class : F
 Service factor : 1.00
 Temperature rise : 80 K
 Design : B

Rev.	Changes Summary	Performed	Checked	Date
Performed by			Page 10 / 36	Revision
Checked by				
Date	11/04/2022			

LOAD PERFORMANCE CURVE

Three Phase Induction Motor - Squirrel Cage



Customer :

Product line : NEMA Premium Efficiency Three-Phase

Product code : 12821872

Catalog # : 00112ET3ER145TC-W22

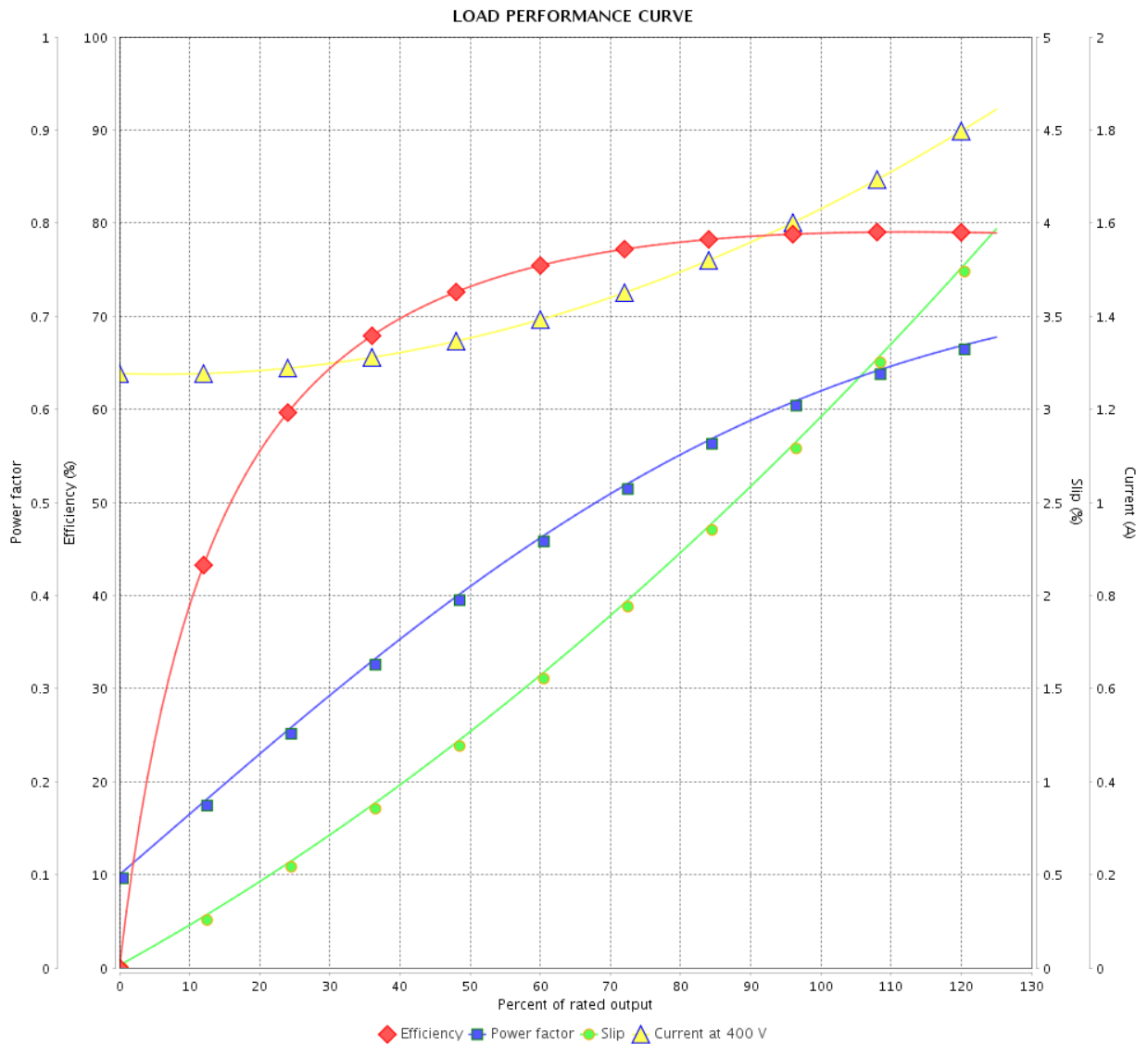

Performance : 400 V 50 Hz 6P IE3

Rated current : 1.62 A
 LRC : 6.1
 Rated torque : 4.06 ft.lb
 Locked rotor torque : 300 %
 Breakdown torque : 330 %
 Rated speed : 970 rpm

Moment of inertia (J) : 0.1595 sq.ft.lb
 Duty cycle : Cont.(S1)
 Insulation class : F
 Service factor : 1.00
 Temperature rise : 80 K
 Design : B

Rev.	Changes Summary	Performed	Checked	Date
Performed by		Page		Revision
Checked by		11 / 36		
Date		11/04/2022		

LOAD PERFORMANCE CURVE

Three Phase Induction Motor - Squirrel Cage



Customer : _____

Product line : NEMA Premium Efficiency Three-Phase

Product code : 12821872

Catalog # : 00112ET3ER145TC-W22

LOAD PERFORMANCE CURVE

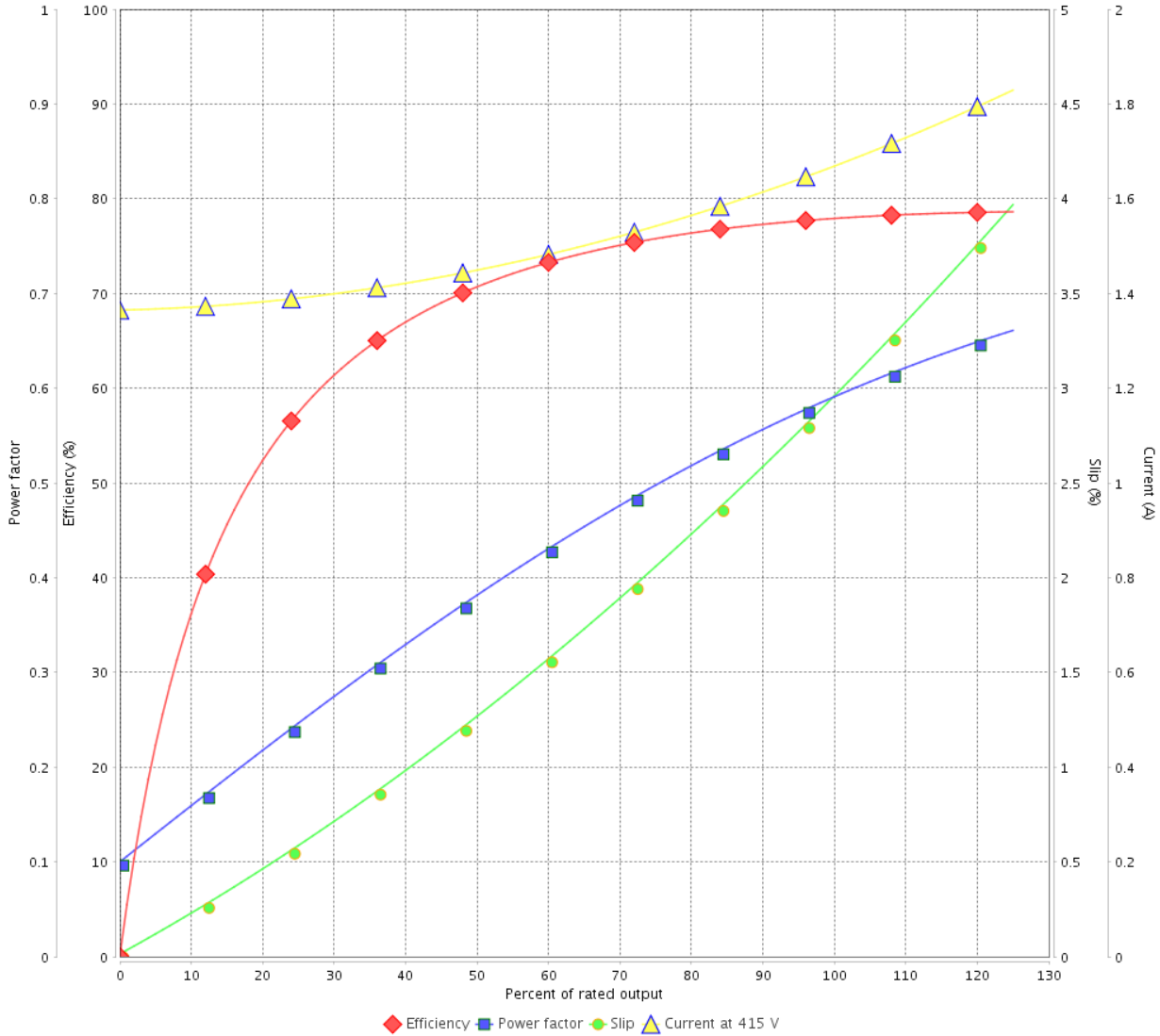

Performance : 415 V 50 Hz 6P IE3

Rated current : 1.66 A
 LRC : 6.3
 Rated torque : 4.06 ft.lb
 Locked rotor torque : 320 %
 Breakdown torque : 340 %
 Rated speed : 970 rpm

Moment of inertia (J) : 0.1595 sq.ft.lb
 Duty cycle : Cont.(S1)
 Insulation class : F
 Service factor : 1.00
 Temperature rise : 80 K
 Design : B

Rev.	Changes Summary	Performed	Checked	Date
Performed by			Page 12 / 36	Revision
Checked by				
Date	11/04/2022			

LOAD PERFORMANCE CURVE

Three Phase Induction Motor - Squirrel Cage



Customer :

Product line : NEMA Premium Efficiency Three-Phase

Product code : 12821872

Catalog # : 00112ET3ER145TC-W22

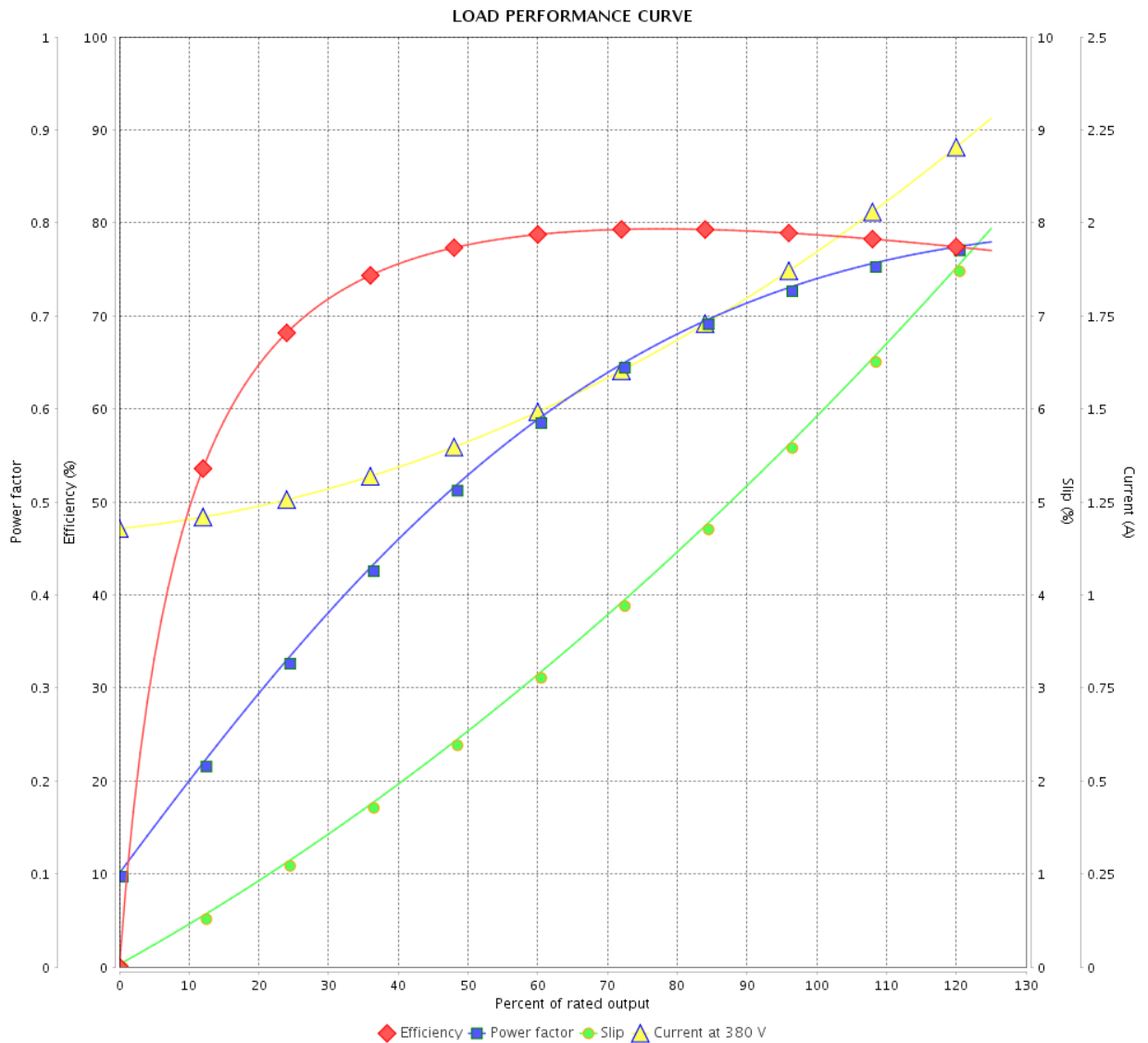

Performance : 380 V 50 Hz 6P IE2

Rated current : 1.96 A
 LRC : 4.8
 Rated torque : 5.59 ft.lb
 Locked rotor torque : 200 %
 Breakdown torque : 220 %
 Rated speed : 940 rpm

Moment of inertia (J) : 0.1595 sq.ft.lb
 Duty cycle : Cont.(S1)
 Insulation class : F
 Service factor : 1.00
 Temperature rise : 80 K
 Design : B

Rev.	Changes Summary	Performed	Checked	Date
Performed by		Page		Revision
Checked by		13 / 36		
Date		11/04/2022		

LOAD PERFORMANCE CURVE

Three Phase Induction Motor - Squirrel Cage



Customer :

Product line : NEMA Premium Efficiency Three-Phase

Product code : 12821872

Catalog # : 00112ET3ER145TC-W22

LOAD PERFORMANCE CURVE

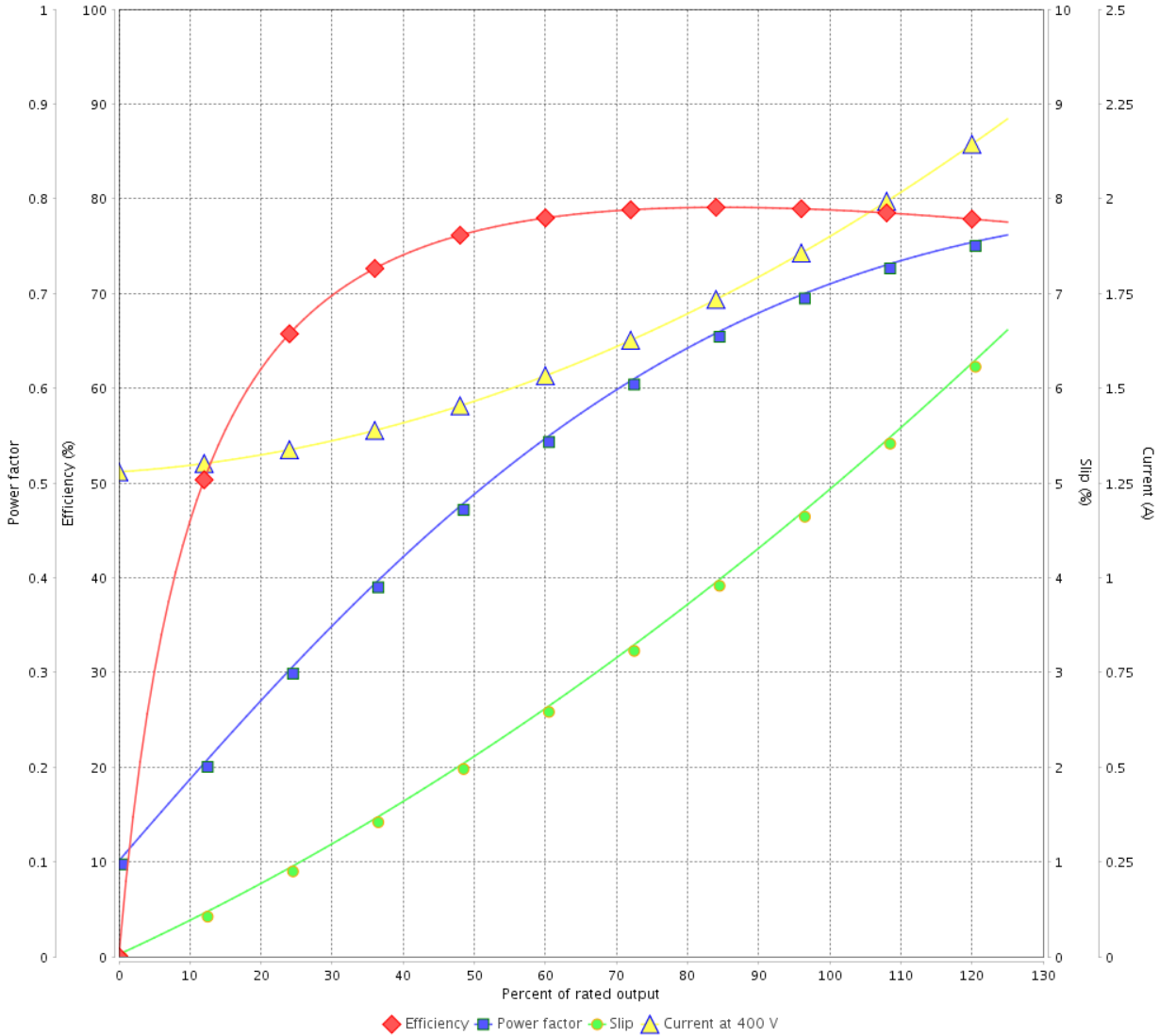

Performance : 400 V 50 Hz 6P IE2

Rated current : 1.94 A
 LRC : 5.2
 Rated torque : 5.53 ft.lb
 Locked rotor torque : 229 %
 Breakdown torque : 260 %
 Rated speed : 950 rpm

Moment of inertia (J) : 0.1595 sq.ft.lb
 Duty cycle : Cont.(S1)
 Insulation class : F
 Service factor : 1.00
 Temperature rise : 80 K
 Design : B

Rev.	Changes Summary	Performed	Checked	Date
Performed by			Page	Revision
Checked by			14 / 36	
Date	11/04/2022			

LOAD PERFORMANCE CURVE

Three Phase Induction Motor - Squirrel Cage



Customer :

Product line : NEMA Premium Efficiency Three-Phase

Product code : 12821872

Catalog # : 00112ET3ER145TC-W22

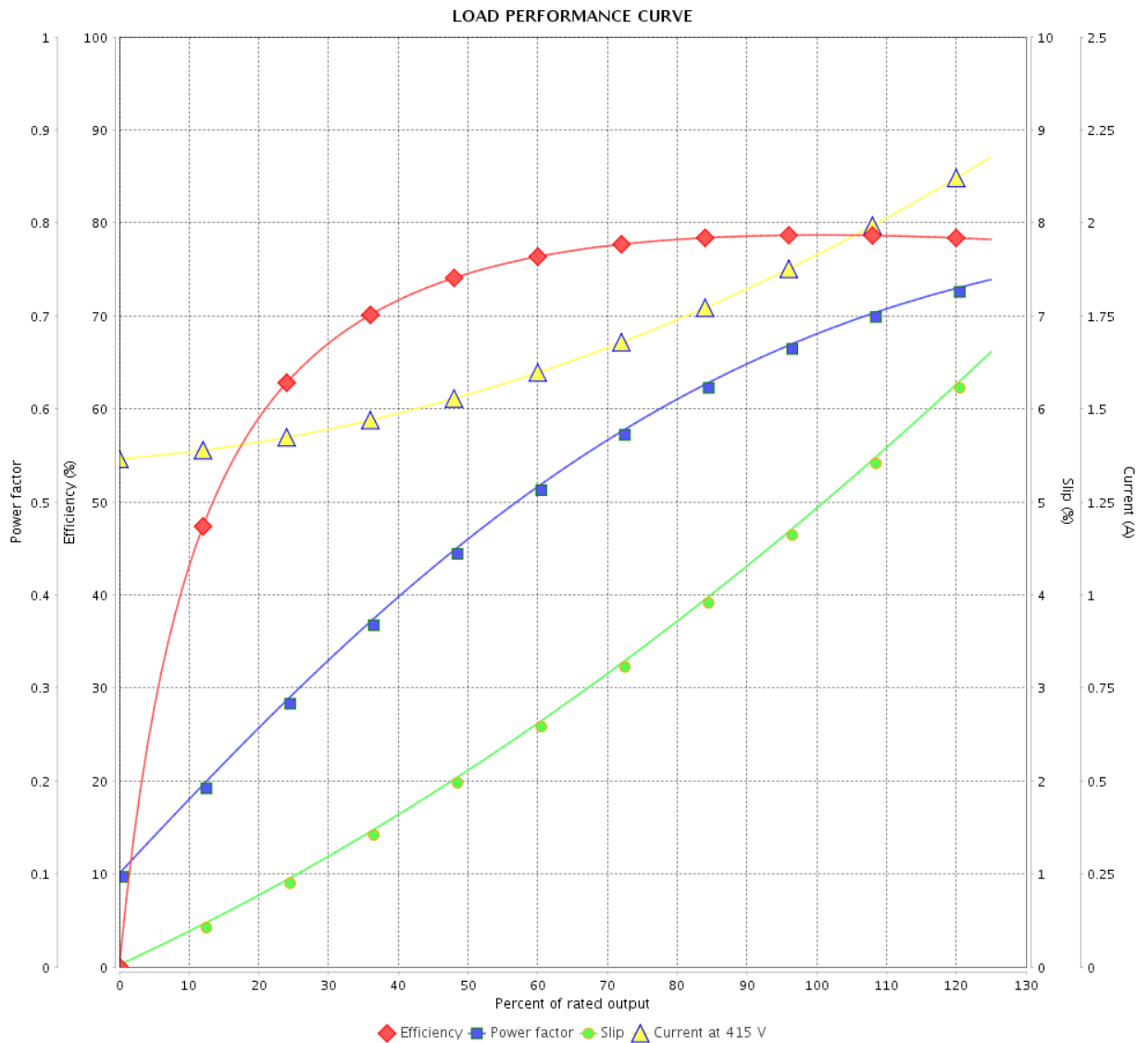

Performance : 415 V 50 Hz 6P IE2

Rated current : 1.95 A
 LRC : 5.5
 Rated torque : 5.53 ft.lb
 Locked rotor torque : 250 %
 Breakdown torque : 280 %
 Rated speed : 950 rpm

Moment of inertia (J) : 0.1595 sq.ft.lb
 Duty cycle : Cont.(S1)
 Insulation class : F
 Service factor : 1.00
 Temperature rise : 80 K
 Design : B

Rev.	Changes Summary	Performed	Checked	Date
Performed by		Page		Revision
Checked by		15 / 36		
Date		11/04/2022		

THERMAL LIMIT CURVE



Three Phase Induction Motor - Squirrel Cage

Customer :

Product line : NEMA Premium Efficiency Three-Phase
 Product code : 12821872
 Catalog # : 00112ET3ER145TC-W22

Performance : 230/460 V 60 Hz 6P

Rated current : 3.46/1.73 A	Moment of inertia (J) : 0.1595 sq.ft.lb
LRC : 6.2	Duty cycle : Cont.(S1)
Rated torque : 4.53 ft.lb	Insulation class : F
Locked rotor torque : 260 %	Service factor : 1.25
Breakdown torque : 300 %	Temperature rise : 80 K
Rated speed : 1160 rpm	Design : B

Heating constant

Cooling constant

Rev.	Changes Summary	Performed	Checked	Date
Performed by			Page 16 / 36	Revision
Checked by				
Date	11/04/2022			

THERMAL LIMIT CURVE

Three Phase Induction Motor - Squirrel Cage



Customer : _____

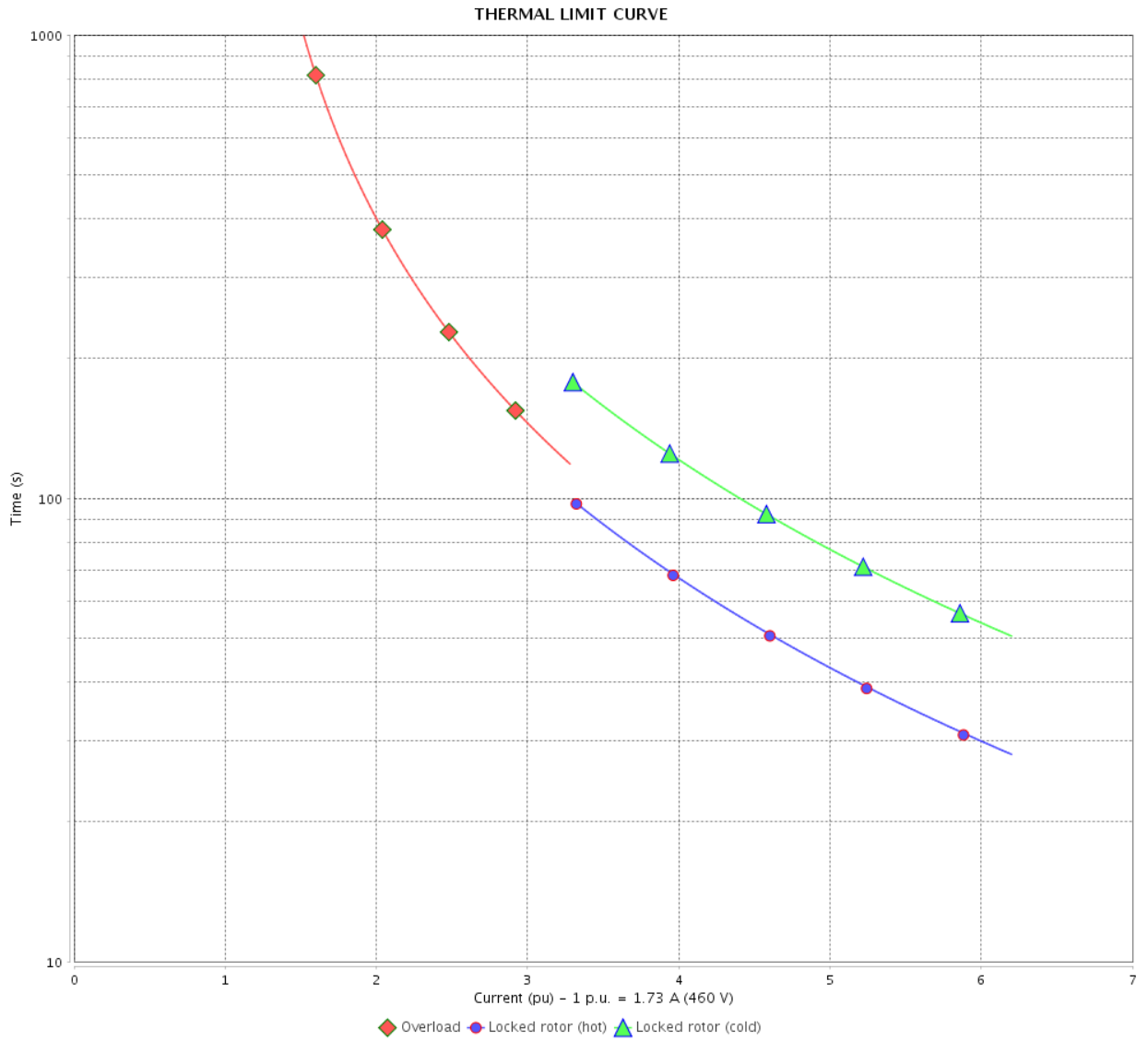

Rev.	Changes Summary	Performed	Checked	Date
Performed by		Page 17 / 36		Revision
Checked by				
Date				

THERMAL LIMIT CURVE



Three Phase Induction Motor - Squirrel Cage

Customer :

Product line : NEMA Premium Efficiency Three-Phase
 Product code : 12821872
 Catalog # : 00112ET3ER145TC-W22

Performance : 380 V 50 Hz 6P IE3

Rated current : 1.60 A	Moment of inertia (J) : 0.1595 sq.ft.lb
LRC : 5.8	Duty cycle : Cont.(S1)
Rated torque : 4.10 ft.lb	Insulation class : F
Locked rotor torque : 280 %	Service factor : 1.00
Breakdown torque : 310 %	Temperature rise : 80 K
Rated speed : 960 rpm	Design : B

Heating constant

Cooling constant

Rev.	Changes Summary	Performed	Checked	Date
Performed by			Page 18 / 36	Revision
Checked by				
Date	11/04/2022			

THERMAL LIMIT CURVE

Three Phase Induction Motor - Squirrel Cage



Customer : _____

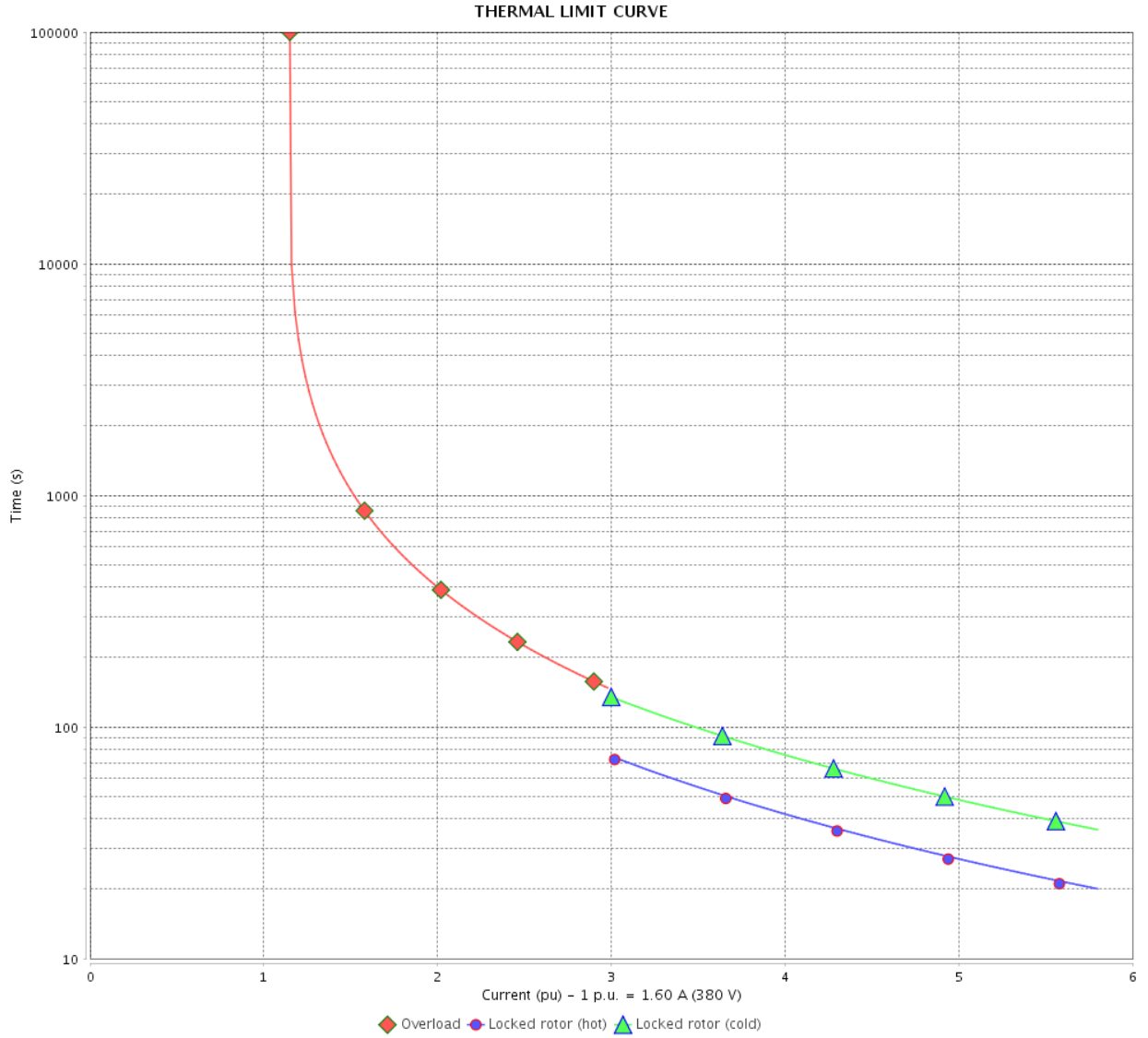

Rev.	Changes Summary	Performed	Checked	Date
Performed by		Page		Revision
Checked by				
Date				

THERMAL LIMIT CURVE



Three Phase Induction Motor - Squirrel Cage

Customer :

Product line : NEMA Premium Efficiency Three-Phase
 Product code : 12821872
 Catalog # : 00112ET3ER145TC-W22

Performance : 400 V 50 Hz 6P IE3

Rated current : 1.62 A	Moment of inertia (J) : 0.1595 sq.ft.lb
LRC : 6.1	Duty cycle : Cont.(S1)
Rated torque : 4.06 ft.lb	Insulation class : F
Locked rotor torque : 300 %	Service factor : 1.00
Breakdown torque : 330 %	Temperature rise : 80 K
Rated speed : 970 rpm	Design : B

Heating constant

Cooling constant

Rev.	Changes Summary	Performed	Checked	Date
Performed by			Page 20 / 36	Revision
Checked by				
Date	11/04/2022			

THERMAL LIMIT CURVE

Three Phase Induction Motor - Squirrel Cage



Customer : _____

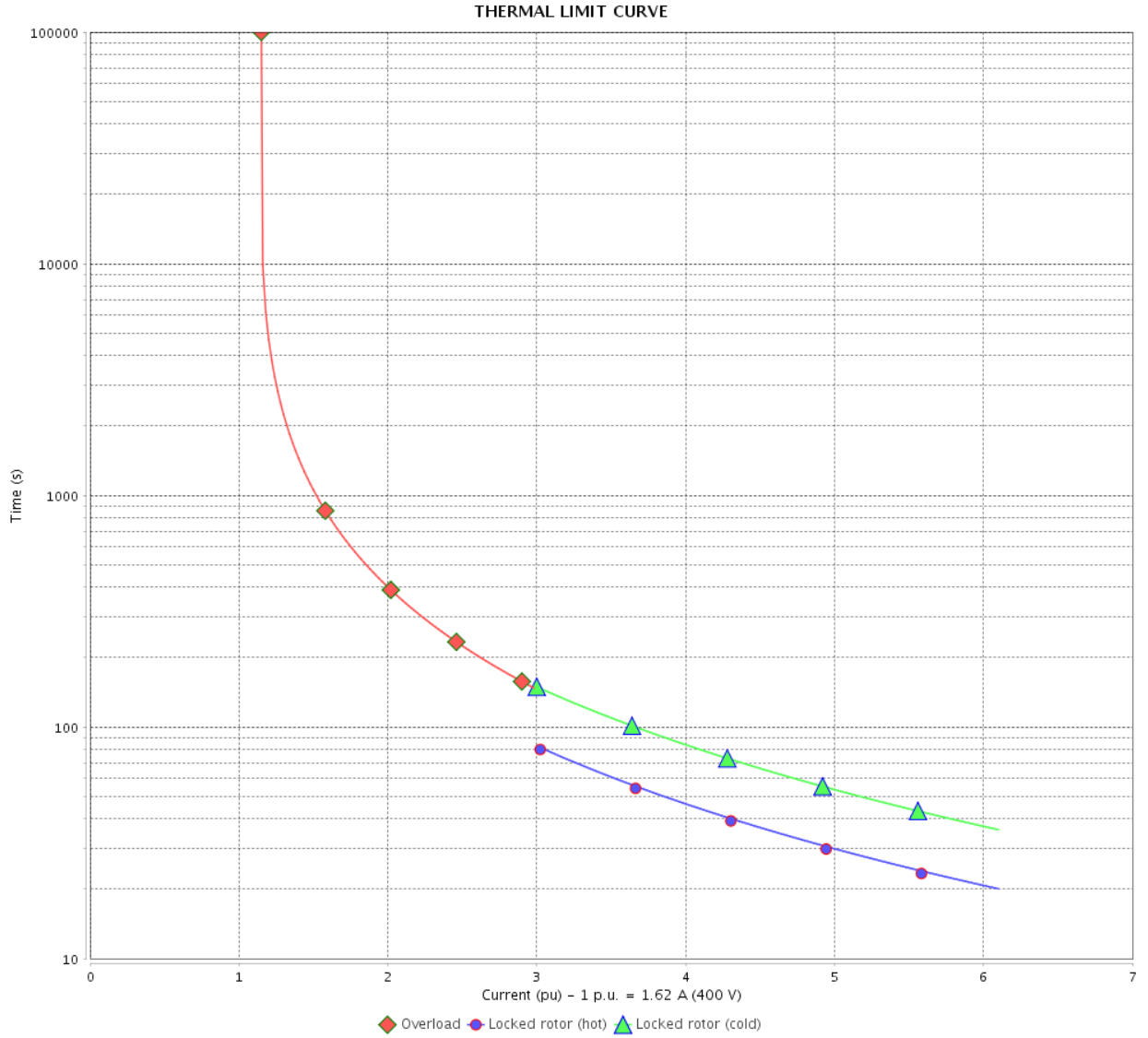

Rev.	Changes Summary	Performed	Checked	Date
Performed by		Page 21 / 36		Revision
Checked by				
Date				

THERMAL LIMIT CURVE



Three Phase Induction Motor - Squirrel Cage

Customer :

Product line : NEMA Premium Efficiency Three-Phase
Product code : 12821872
Catalog # : 00112ET3ER145TC-W22

Performance : 415 V 50 Hz 6P IE3

Rated current	: 1.66 A	Moment of inertia (J)	: 0.1595 sq.ft.lb
LRC	: 6.3	Duty cycle	: Cont.(S1)
Rated torque	: 4.06 ft.lb	Insulation class	: F
Locked rotor torque	: 320 %	Service factor	: 1.00
Breakdown torque	: 340 %	Temperature rise	: 80 K
Rated speed	: 970 rpm	Design	: B

Heating constant

Cooling constant

Rev.	Changes Summary	Performed	Checked	Date
Performed by				
Checked by			Page	Revision
Date	11/04/2022		22 / 36	

THERMAL LIMIT CURVE

Three Phase Induction Motor - Squirrel Cage



Customer : _____

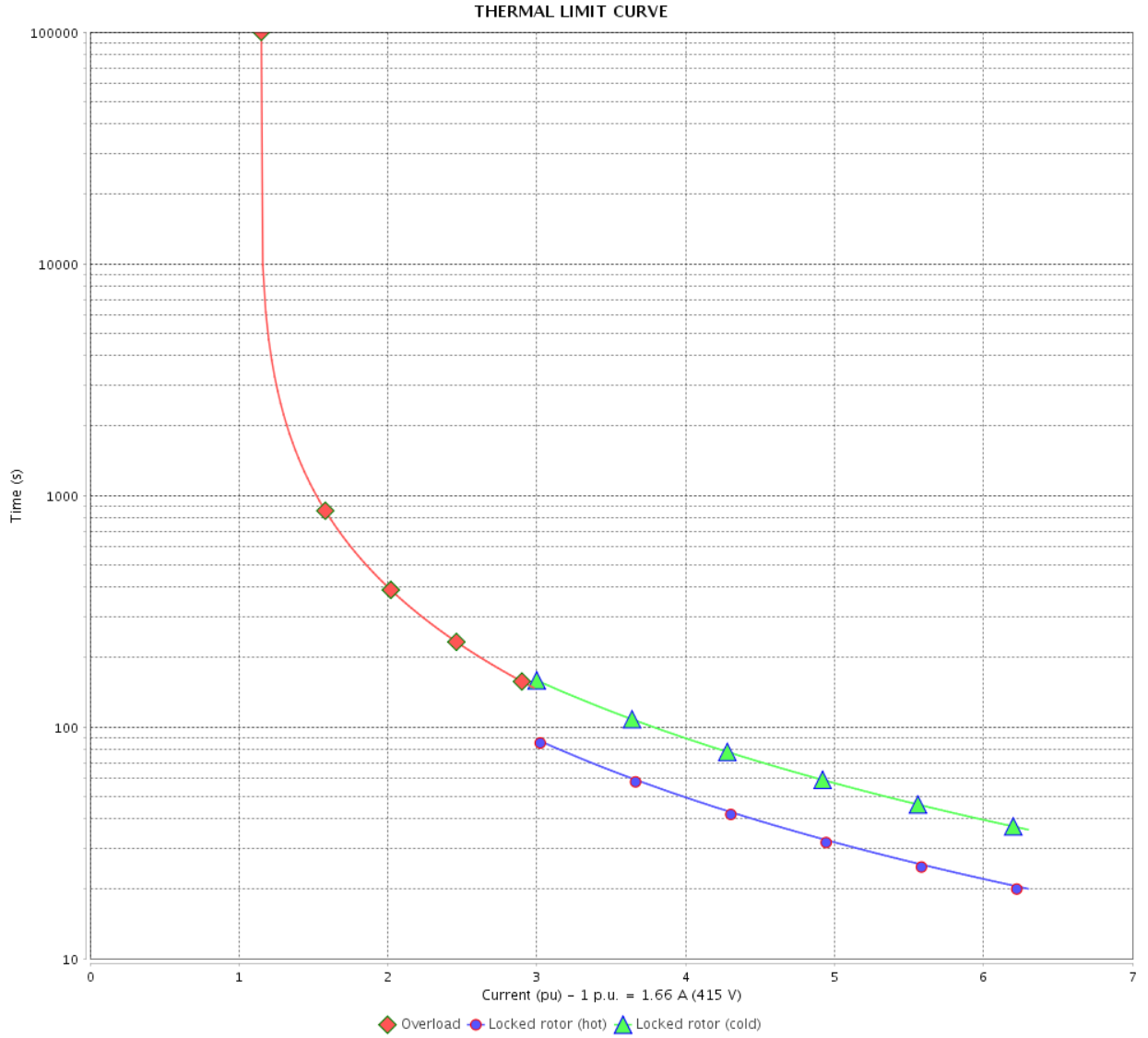

Rev.	Changes Summary	Performed	Checked	Date
Performed by		Page 23 / 36		Revision
Checked by				
Date				

THERMAL LIMIT CURVE



Three Phase Induction Motor - Squirrel Cage

Customer :

Product line : NEMA Premium Efficiency Three-Phase
Product code : 12821872
Catalog # : 00112ET3ER145TC-W22

Performance : 380 V 50 Hz 6P IE2

Rated current	: 1.96 A	Moment of inertia (J)	: 0.1595 sq.ft.lb
LRC	: 4.8	Duty cycle	: Cont.(S1)
Rated torque	: 5.59 ft.lb	Insulation class	: F
Locked rotor torque	: 200 %	Service factor	: 1.00
Breakdown torque	: 220 %	Temperature rise	: 80 K
Rated speed	: 940 rpm	Design	: B

Heating constant

Cooling constant

Rev.	Changes Summary	Performed	Checked	Date
Performed by				
Checked by			Page	Revision
Date	11/04/2022		24 / 36	

THERMAL LIMIT CURVE

Three Phase Induction Motor - Squirrel Cage



Customer : _____

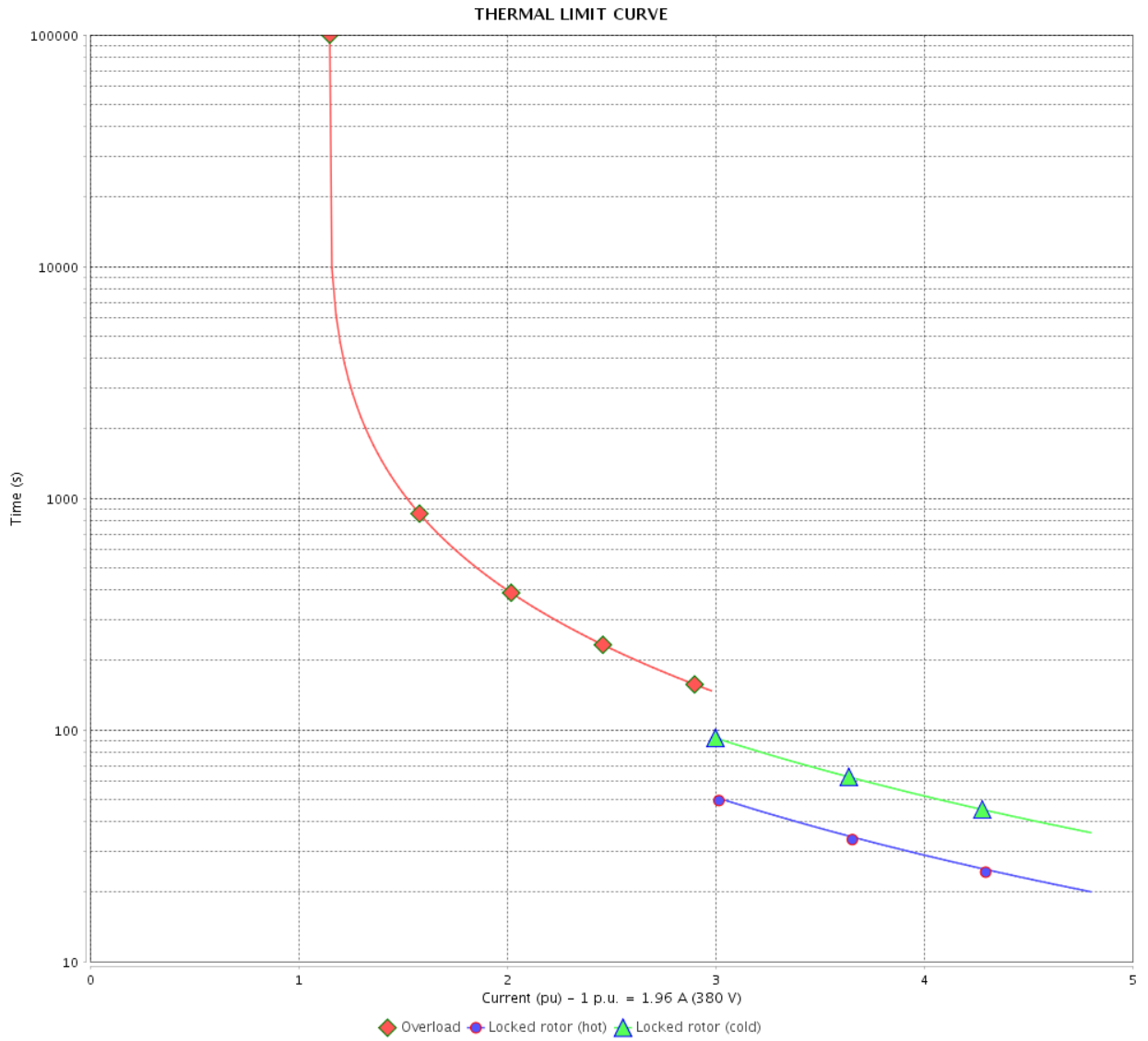

Rev.	Changes Summary	Performed	Checked	Date
Performed by		Page Revision 25 / 36		
Checked by				
Date				

THERMAL LIMIT CURVE

Three Phase Induction Motor - Squirrel Cage



Customer :

Product line : NEMA Premium Efficiency Three-Phase
Product code : 12821872
Catalog # : 00112ET3ER145TC-W22

Performance : 400 V 50 Hz 6P IE2

Rated current	: 1.94 A	Moment of inertia (J)	: 0.1595 sq.ft.lb
LRC	: 5.2	Duty cycle	: Cont.(S1)
Rated torque	: 5.53 ft.lb	Insulation class	: F
Locked rotor torque	: 229 %	Service factor	: 1.00
Breakdown torque	: 260 %	Temperature rise	: 80 K
Rated speed	: 950 rpm	Design	: B

Heating constant

Cooling constant

Rev.	Changes Summary	Performed	Checked	Date
Performed by				
Checked by			Page	Revision
Date	11/04/2022		26 / 36	

THERMAL LIMIT CURVE

Three Phase Induction Motor - Squirrel Cage



Customer : _____

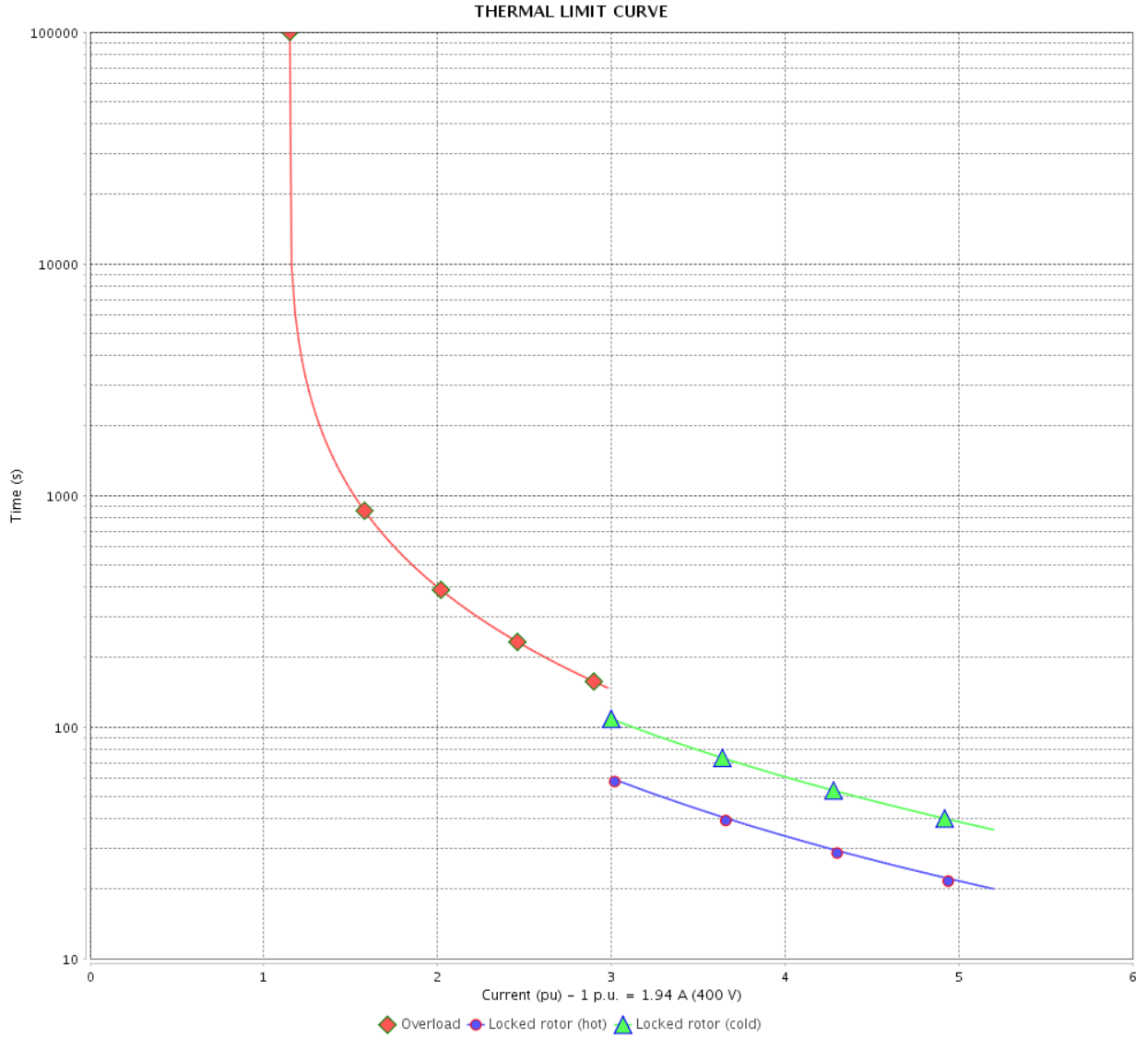

Rev.	Changes Summary	Performed	Checked	Date
Performed by		Page 27 / 36 Revision		
Checked by				
Date				

THERMAL LIMIT CURVE



Three Phase Induction Motor - Squirrel Cage

Customer :

Product line : NEMA Premium Efficiency Three-Phase
Product code : 12821872
Catalog # : 00112ET3ER145TC-W22

Performance : 415 V 50 Hz 6P IE2

Rated current	: 1.95 A	Moment of inertia (J)	: 0.1595 sq.ft.lb
LRC	: 5.5	Duty cycle	: Cont.(S1)
Rated torque	: 5.53 ft.lb	Insulation class	: F
Locked rotor torque	: 250 %	Service factor	: 1.00
Breakdown torque	: 280 %	Temperature rise	: 80 K
Rated speed	: 950 rpm	Design	: B

Heating constant

Cooling constant

Rev.	Changes Summary	Performed	Checked	Date
Performed by				
Checked by			Page	Revision
Date	11/04/2022		28 / 36	

THERMAL LIMIT CURVE

Three Phase Induction Motor - Squirrel Cage



Customer : _____

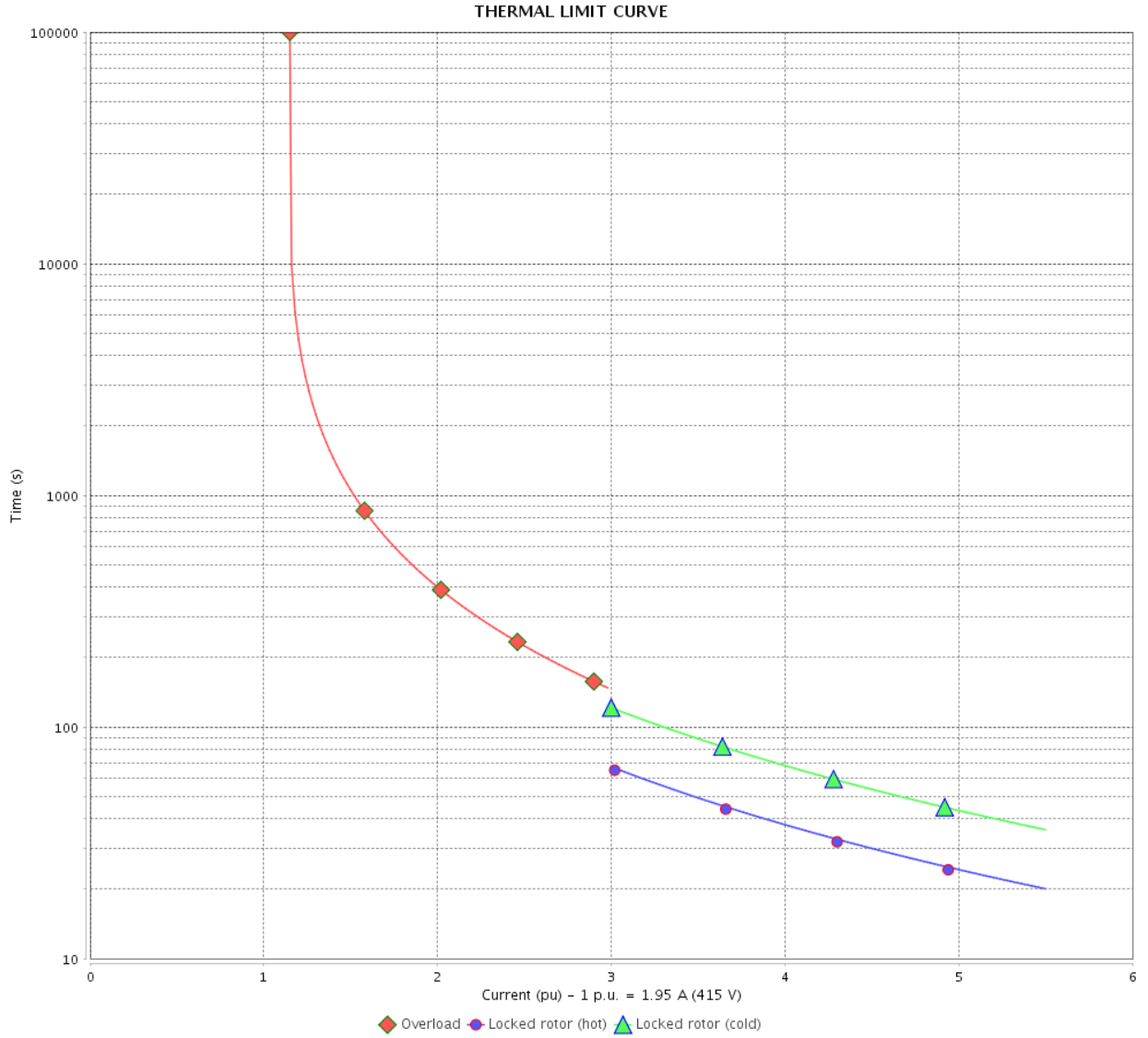

Rev.	Changes Summary	Performed	Checked	Date
Performed by		Page		Revision
Checked by		29 / 36		
Date		11/04/2022		

VFD OPERATION CURVE

Three Phase Induction Motor - Squirrel Cage



Customer :

Product line : NEMA Premium Efficiency Three-Phase

Product code : 12821872

Catalog # : 00112ET3ER145TC-W22

VFD OPERATION CURVE

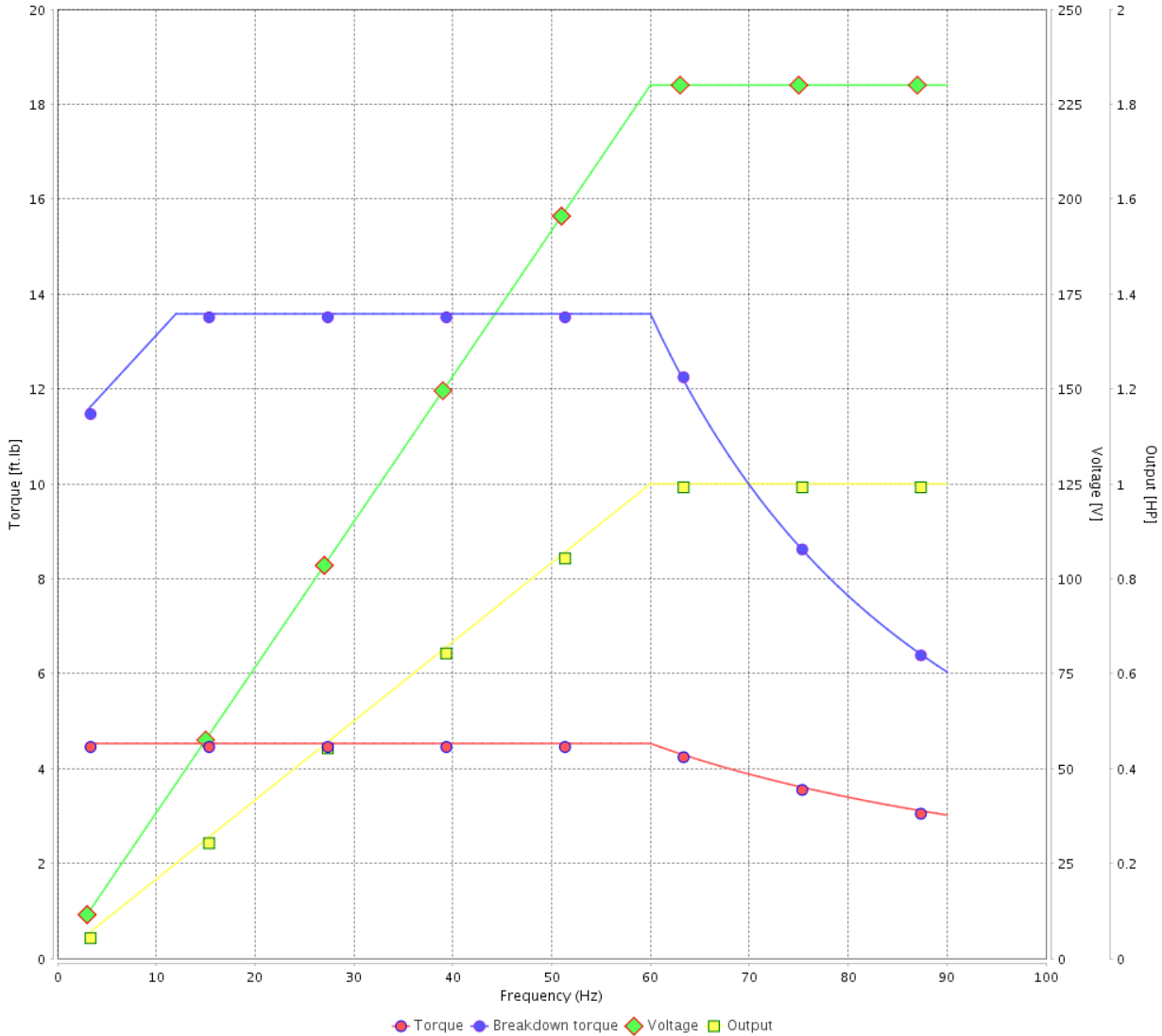

Performance : 230/460 V 60 Hz 6P

Rated current : 3.46/1.73 A
 LRC : 6.2
 Rated torque : 4.53 ft.lb
 Locked rotor torque : 260 %
 Breakdown torque : 300 %
 Rated speed : 1160 rpm

Moment of inertia (J) : 0.1595 sq.ft.lb
 Duty cycle : Cont.(S1)
 Insulation class : F
 Service factor : 1.25
 Temperature rise : 80 K
 Design : B

Rev.	Changes Summary	Performed	Checked	Date
Performed by			Page	Revision
Checked by				
Date				

VFD OPERATION CURVE

Three Phase Induction Motor - Squirrel Cage



Customer :

Product line : NEMA Premium Efficiency Three-Phase

Product code : 12821872

Catalog # : 00112ET3ER145TC-W22

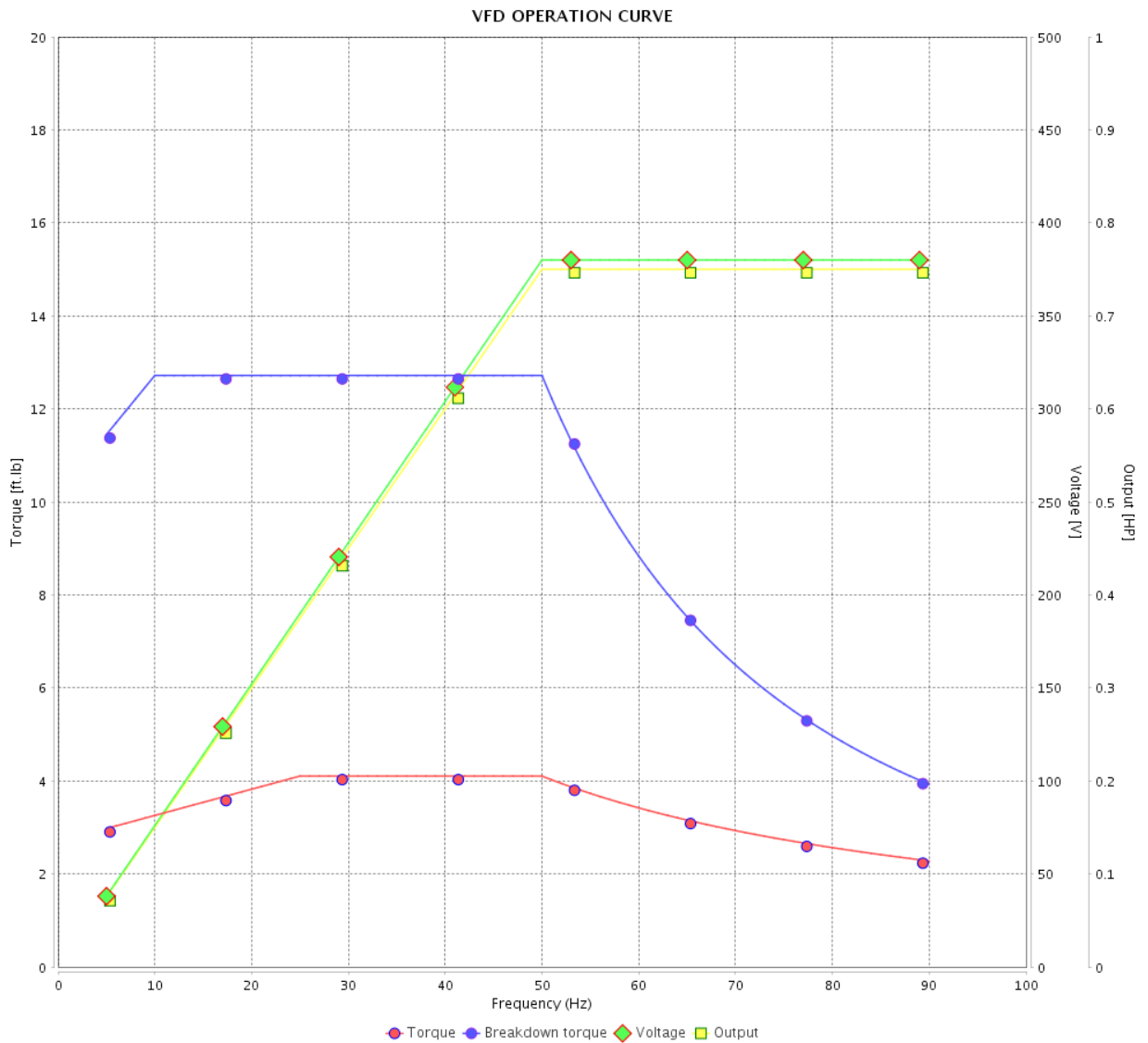

Performance : 380 V 50 Hz 6P IE3

Rated current : 1.60 A
 LRC : 5.8
 Rated torque : 4.10 ft.lb
 Locked rotor torque : 280 %
 Breakdown torque : 310 %
 Rated speed : 960 rpm

Moment of inertia (J) : 0.1595 sq.ft.lb
 Duty cycle : Cont.(S1)
 Insulation class : F
 Service factor : 1.00
 Temperature rise : 80 K
 Design : B

Rev.	Changes Summary	Performed	Checked	Date
Performed by		Page		Revision
Checked by		31 / 36		
Date		11/04/2022		

VFD OPERATION CURVE

Three Phase Induction Motor - Squirrel Cage



Customer : _____

Product line : NEMA Premium Efficiency Three-Phase

Product code : 12821872

Catalog # : 00112ET3ER145TC-W22

VFD OPERATION CURVE

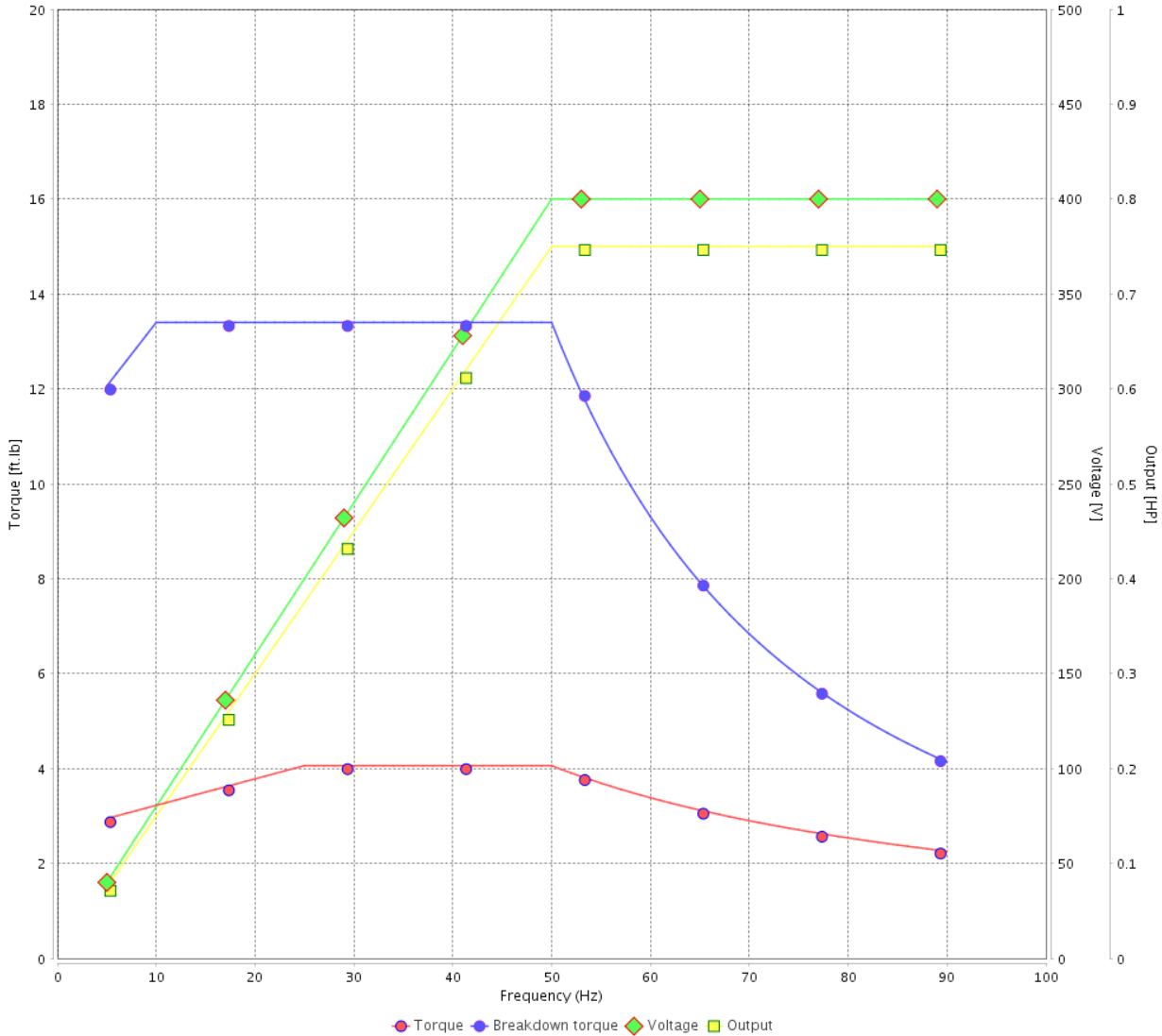

Performance : 400 V 50 Hz 6P IE3

Rated current : 1.62 A
 LRC : 6.1
 Rated torque : 4.06 ft.lb
 Locked rotor torque : 300 %
 Breakdown torque : 330 %
 Rated speed : 970 rpm

Moment of inertia (J) : 0.1595 sq.ft.lb
 Duty cycle : Cont.(S1)
 Insulation class : F
 Service factor : 1.00
 Temperature rise : 80 K
 Design : B

Rev.	Changes Summary	Performed	Checked	Date
Performed by			Page 32 / 36	Revision
Checked by				
Date	11/04/2022			

VFD OPERATION CURVE

Three Phase Induction Motor - Squirrel Cage



Customer : _____

Product line : NEMA Premium Efficiency Three-Phase

Product code : 12821872

Catalog # : 00112ET3ER145TC-W22

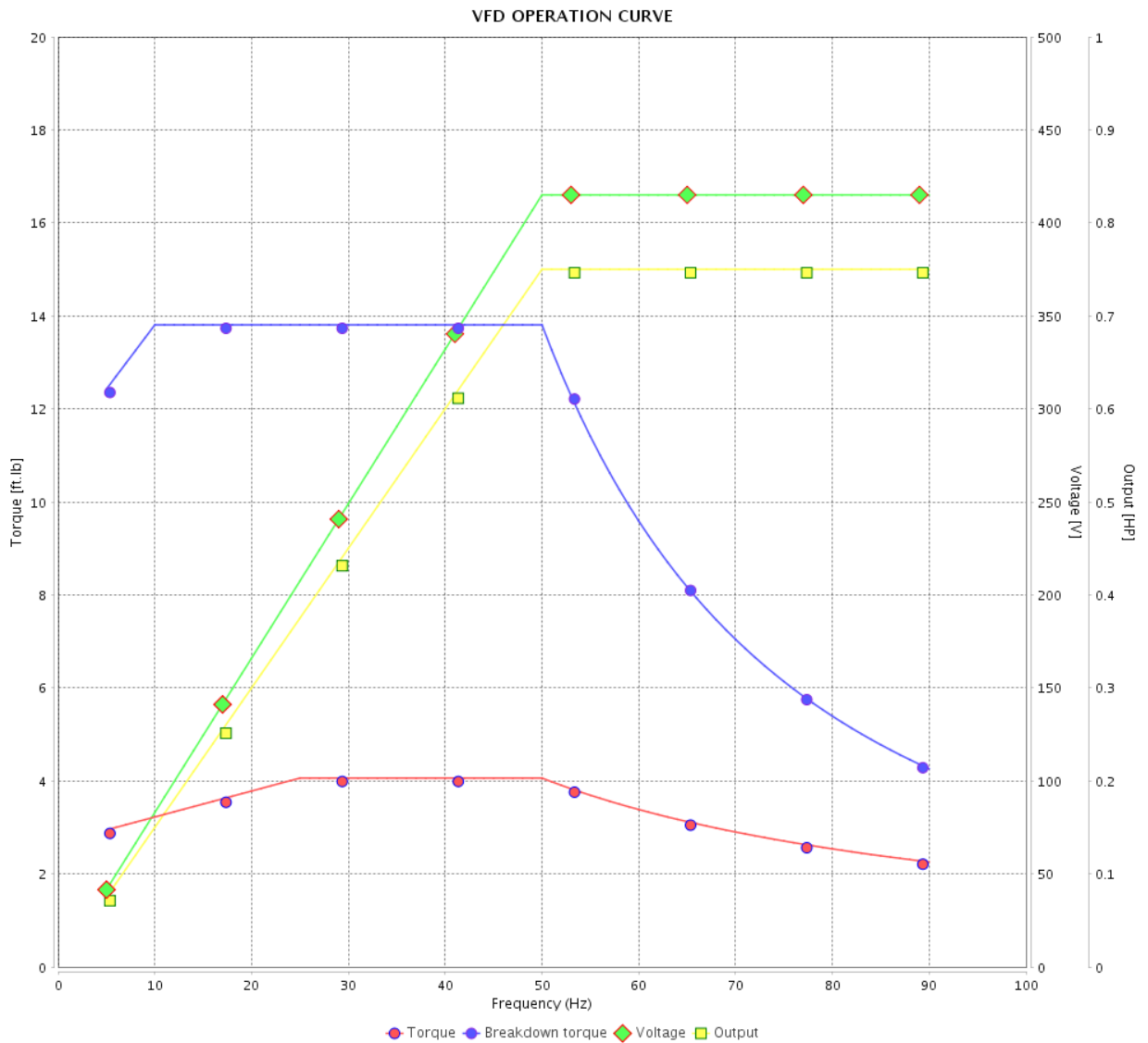

Performance : 415 V 50 Hz 6P IE3

Rated current : 1.66 A
 LRC : 6.3
 Rated torque : 4.06 ft.lb
 Locked rotor torque : 320 %
 Breakdown torque : 340 %
 Rated speed : 970 rpm

Moment of inertia (J) : 0.1595 sq.ft.lb
 Duty cycle : Cont.(S1)
 Insulation class : F
 Service factor : 1.00
 Temperature rise : 80 K
 Design : B

Rev.	Changes Summary	Performed	Checked	Date
Performed by				Page 33 / 36
Checked by				
Date	11/04/2022			

VFD OPERATION CURVE

Three Phase Induction Motor - Squirrel Cage



Customer :

Product line : NEMA Premium Efficiency Three-Phase

Product code : 12821872

Catalog # : 00112ET3ER145TC-W22

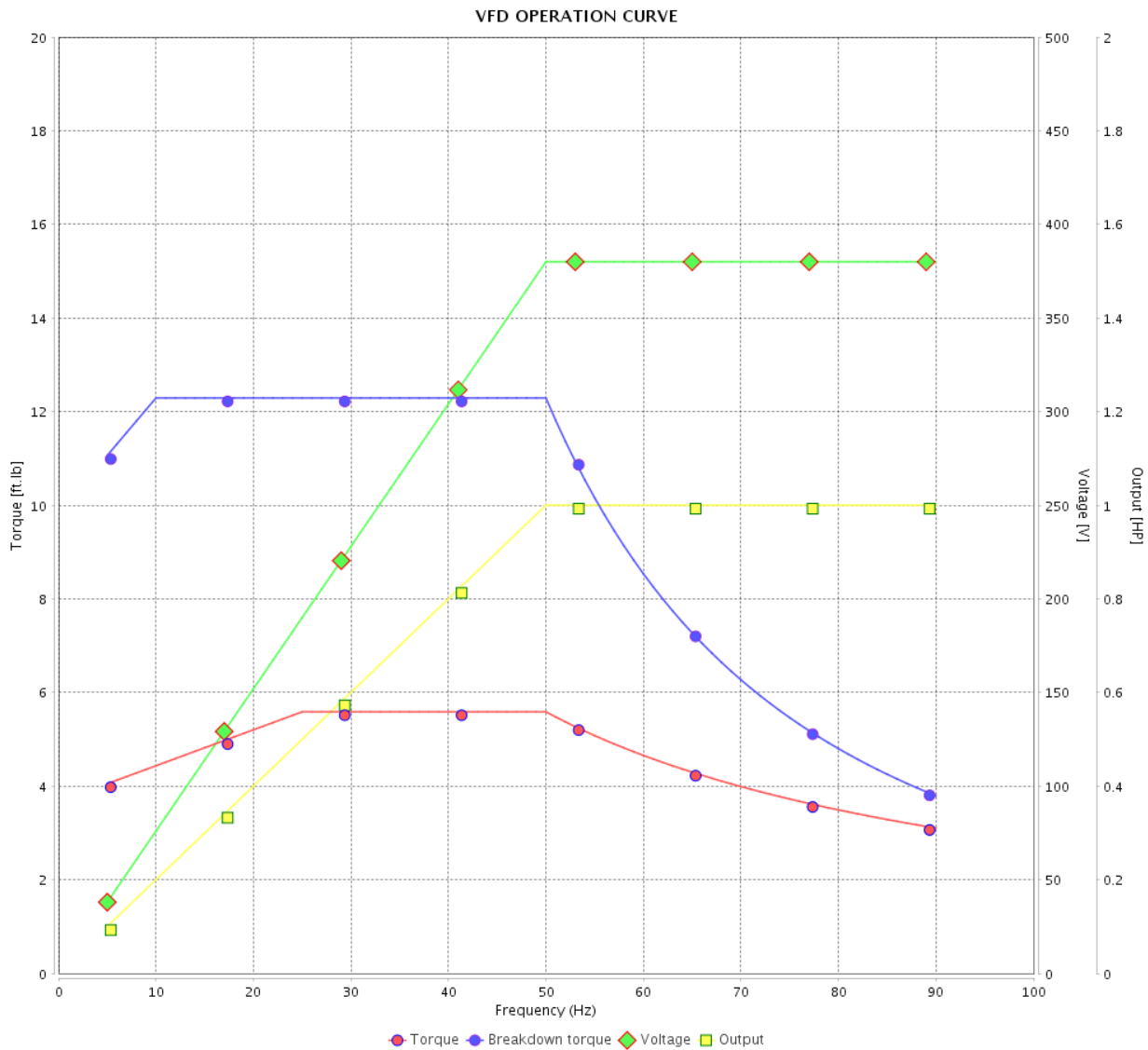

Performance : 380 V 50 Hz 6P IE2

Rated current : 1.96 A
 LRC : 4.8
 Rated torque : 5.59 ft.lb
 Locked rotor torque : 200 %
 Breakdown torque : 220 %
 Rated speed : 940 rpm

Moment of inertia (J) : 0.1595 sq.ft.lb
 Duty cycle : Cont.(S1)
 Insulation class : F
 Service factor : 1.00
 Temperature rise : 80 K
 Design : B

Rev.	Changes Summary	Performed	Checked	Date
Performed by			Page 34 / 36	Revision
Checked by				
Date	11/04/2022			

VFD OPERATION CURVE

Three Phase Induction Motor - Squirrel Cage



Customer :

Product line : NEMA Premium Efficiency Three-Phase

Product code : 12821872

Catalog # : 00112ET3ER145TC-W22

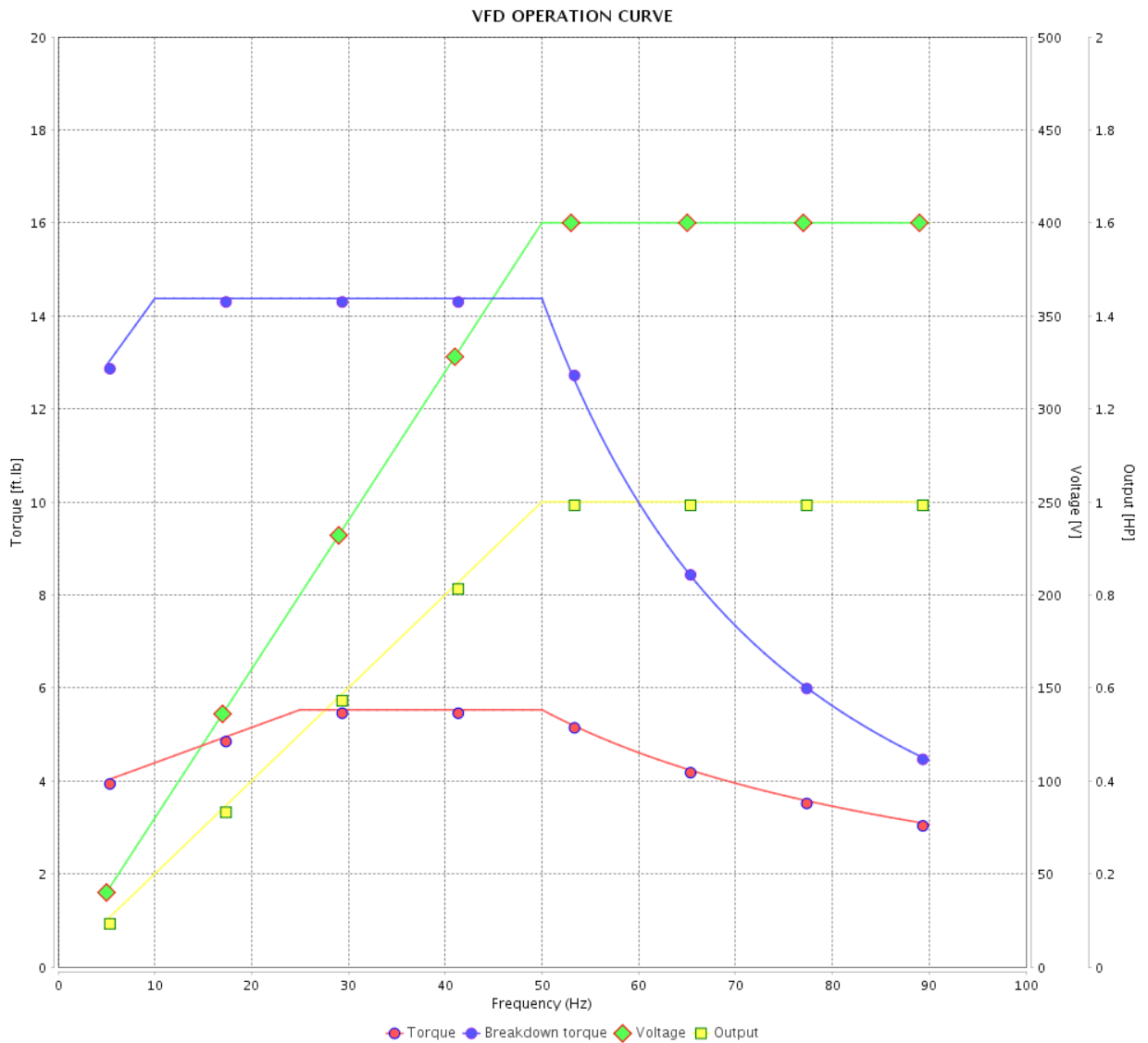

Performance : 400 V 50 Hz 6P IE2

Rated current : 1.94 A
 LRC : 5.2
 Rated torque : 5.53 ft.lb
 Locked rotor torque : 229 %
 Breakdown torque : 260 %
 Rated speed : 950 rpm

Moment of inertia (J) : 0.1595 sq.ft.lb
 Duty cycle : Cont.(S1)
 Insulation class : F
 Service factor : 1.00
 Temperature rise : 80 K
 Design : B

Rev.	Changes Summary	Performed	Checked	Date
Performed by				Page 35 / 36
Checked by				
Date	11/04/2022			

VFD OPERATION CURVE

Three Phase Induction Motor - Squirrel Cage



Customer :

Product line : NEMA Premium Efficiency Three-Phase

Product code : 12821872

Catalog # : 00112ET3ER145TC-W22

VFD OPERATION CURVE

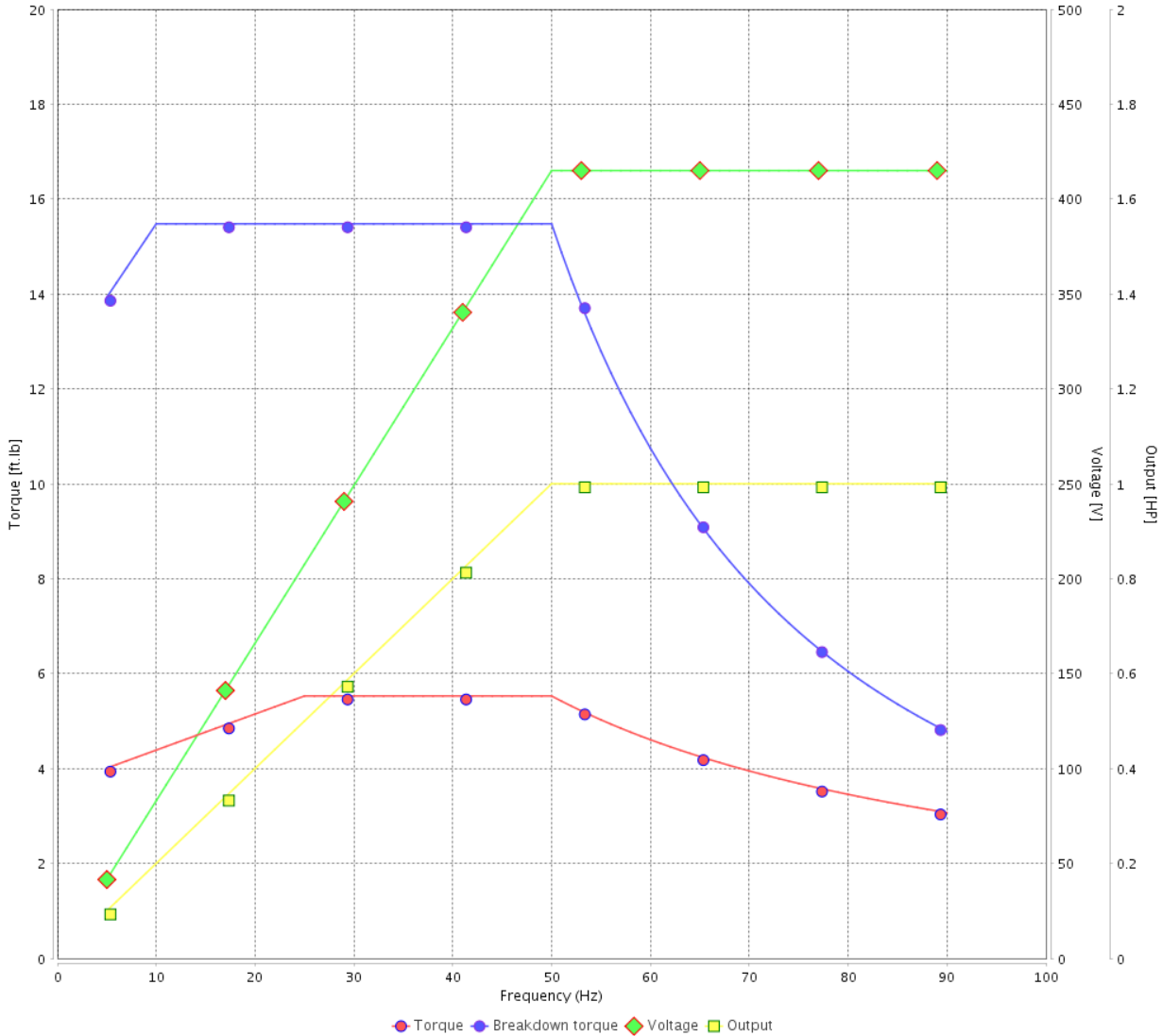

Performance : 415 V 50 Hz 6P IE2

Rated current : 1.95 A
 LRC : 5.5
 Rated torque : 5.53 ft.lb
 Locked rotor torque : 250 %
 Breakdown torque : 280 %
 Rated speed : 950 rpm

Moment of inertia (J) : 0.1595 sq.ft.lb
 Duty cycle : Cont.(S1)
 Insulation class : F
 Service factor : 1.00
 Temperature rise : 80 K
 Design : B

Rev.	Changes Summary	Performed	Checked	Date
Performed by			Page 36 / 36	Revision
Checked by				
Date	11/04/2022			

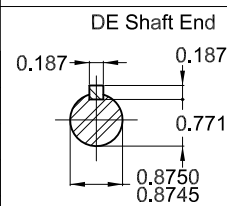
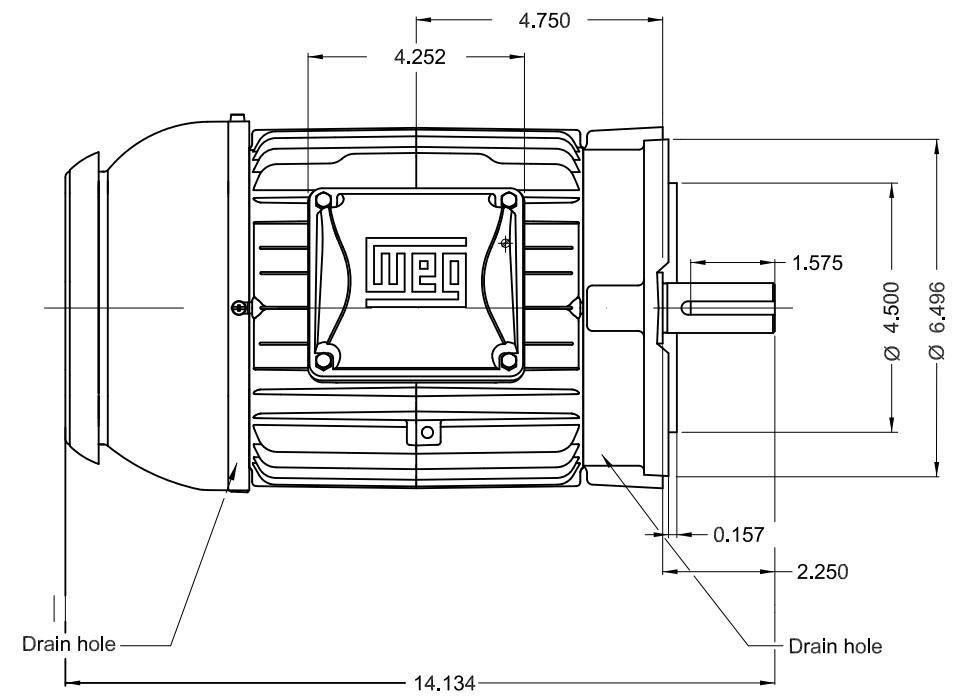
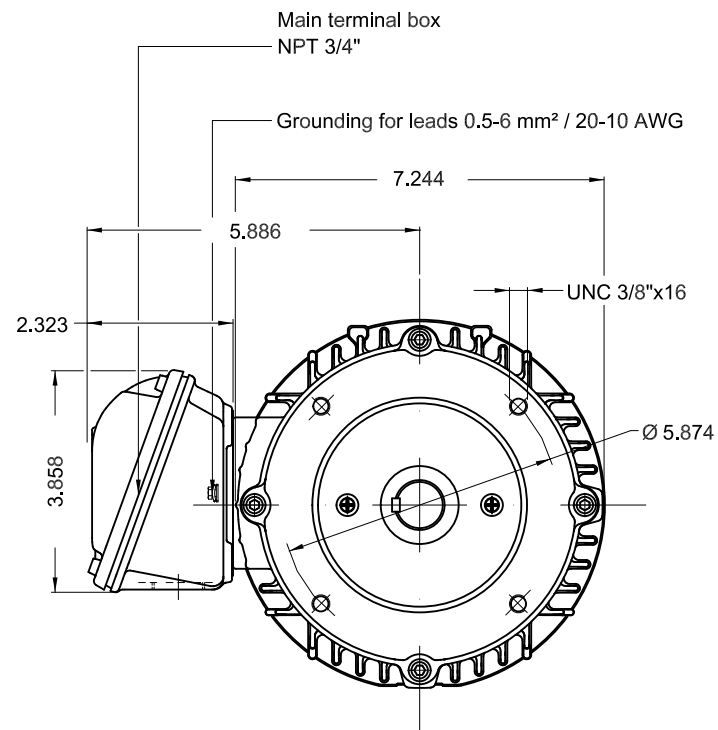

Bearing cap
 Color RAL 5009
 Painting plan 207A
 Mounting NEMA W-6
 Mounting V18

1 HP 06 Poles 60 Hz

Dimensions in inches

ECM	LOC	SUMMARY OF MODIFICATIONS	EXECUTED	CHECKED	RELEASED	DATE	VER
EXECUTED	PIRWBUSER	THREE PH. MOTOR W22 PREM. EFF.					
CHECKED		FRAME 145TC IP55 TEFC					
RELEASED							
REL DT.	WMO	Jaragua do Sul	Product Engineering				

PREVIEW
 WDD



SHEET 1 / 1

MADE IN BRAZIL
12821872



W22

MODEL 00112ET3ER145TC-W22

Inverter Duty Motor
Severe Duty



For use on 60Hz
Class I, Div 2, Gr A, B, C and D - T3
Class I, Zone 2, IIC - T3
Class II, Div 2, Gr F and G - T5
For use on PWM: Gr. A, B, C, D, F and G,
VT 1000:1, CT 20:1, 1.00SF - T4A



FOR SAFE AREA
Mod. TE1BFOXON
CC029A

PH3 60Hz Fr. 145TC 1000m.a.s.l. IP55 TEFC 53lb

V 230/460

A 3.46/1.73

HP 1.0

kW 0.75

SF 1.25

SFA 4.33/2.16

RPM 1160

PF 0.66

AMB 40°C

INS cl. F DT80K

NEMA NOM EFF 82.5%

DUTY CONT.

DES B Code K

USABLE @208V 3.82A SF 1.15 SFA 4.39

1.0HP 0.75kW 50Hz 380V 1.96A 940RPM SF 1.00 EFF 78.5% (IE2)

