

# DATA SHEET

## Three Phase Induction Motor - Squirrel Cage



Customer :							
Product line	: NEMA Premium Efficiency Three-Phase	Product code :	12821880				
		Catalog # :	00136ET3ER143TC-W22				
Frame	: 143TC	Cooling method	: IC411 - TEFC				
Insulation class	: F	Mounting	: W-6				
Duty cycle	: Cont.(S1)	Rotation <sup>1</sup>	: Both (CW and CCW)				
Ambient temperature	: -20°C to +40°C	Starting method	: Direct On Line				
Altitude	: 1000 m.a.s.l.	Approx. weight <sup>2</sup>	: 39.8 lb				
Protection degree	: IP55	Moment of inertia (J)	: 0.0332 sq.ft.lb				
Output [HP]	1	0.75	0.75	0.75	1	1	1
Poles	2	2	2	2	2	2	2
Frequency [Hz]	60	50	50	50	50	50	50
Rated voltage [V]	230/460	380	400	415	380	400	415
Rated current [A]	2.88/1.44	1.31	1.30	1.30	1.68	1.65	1.63
L. R. Amperes [A]	23.6/11.8	11.3	11.7	12.2	11.3	11.9	12.6
LRC [A]	8.2x(Code L)	8.6x(Code M)	9.0x(Code M)	9.4x(Code N)	6.7x(Code J)	7.2x(Code K)	7.7x(Code L)
No load current [A]	1.42/0.710	0.700	0.750	0.800	0.700	0.750	0.800
Rated speed [RPM]	3500	2910	2920	2925	2865	2880	2895
Slip [%]	2.78	3.00	2.67	2.50	4.50	4.00	3.50
Rated torque [ft.lb]	1.50	1.35	1.35	1.35	1.83	1.82	1.81
Locked rotor torque [%]	320	330	370	409	240	270	300
Breakdown torque [%]	400	400	450	500	280	320	350
Service factor	1.25	1.25	1.25	1.25	1.25	1.25	1.25
Temperature rise	80 K	80 K	80 K	80 K	80 K	80 K	80 K
Locked rotor time	39s (cold) 22s (hot)	27s (cold) 15s (hot)	27s (cold) 15s (hot)	27s (cold) 15s (hot)	27s (cold) 15s (hot)	27s (cold) 15s (hot)	27s (cold) 15s (hot)
Noise level <sup>2</sup>	68.0 dB(A)	62.0 dB(A)	62.0 dB(A)	62.0 dB(A)	62.0 dB(A)	62.0 dB(A)	62.0 dB(A)
Efficiency (%)	25%	72.7	69.6	69.0	68.4	75.4	75.4
	50%	75.0	72.9	72.3	71.7	77.0	77.0
	75%	79.0	77.6	77.6	77.6	78.5	78.5
	100%	81.5	81.5	81.5	81.5	80.0	80.0
Power Factor	25%	0.39	0.36	0.33	0.30	0.43	0.39
	50%	0.63	0.58	0.53	0.50	0.68	0.63
	75%	0.74	0.70	0.66	0.63	0.78	0.75
	100%	0.80	0.78	0.75	0.72	0.85	0.82
Bearing type	: Drive end : 6205 ZZ	Non drive end : 6204 ZZ	Foundation loads				
Sealing	: V'Ring	V'Ring	Max. traction	: 35 lb			
Lubrication interval	: -	-	Max. compression	: 75 lb			
Lubricant amount	: -	-					
Lubricant type	: Mobil Polyrex EM						
Notes USABLE @208V 3.16A SF 1.15 SFA 3.64A							
This revision replaces and cancel the previous one, which must be eliminated. (1) Looking the motor from the shaft end. (2) Measured at 1m and with tolerance of +3dB(A). (3) Approximate weight subject to changes after manufacturing process. (4) At 100% of full load.				These are average values based on tests with sinusoidal power supply, subject to the tolerances stipulated in NEMA MG-1.			
Rev.	Changes Summary			Performed	Checked	Date	
Performed by							
Checked by					Page	Revision	
Date	11/04/2022				1 / 36		

# TORQUE AND CURRENT VS SPEED CURVE

Three Phase Induction Motor - Squirrel Cage



Customer :

Product line : NEMA Premium Efficiency Three-Phase

Product code : 12821880

Catalog # : 00136ET3ER143TC-W22

TORQUE AND CURRENT VS SPEED CURVE

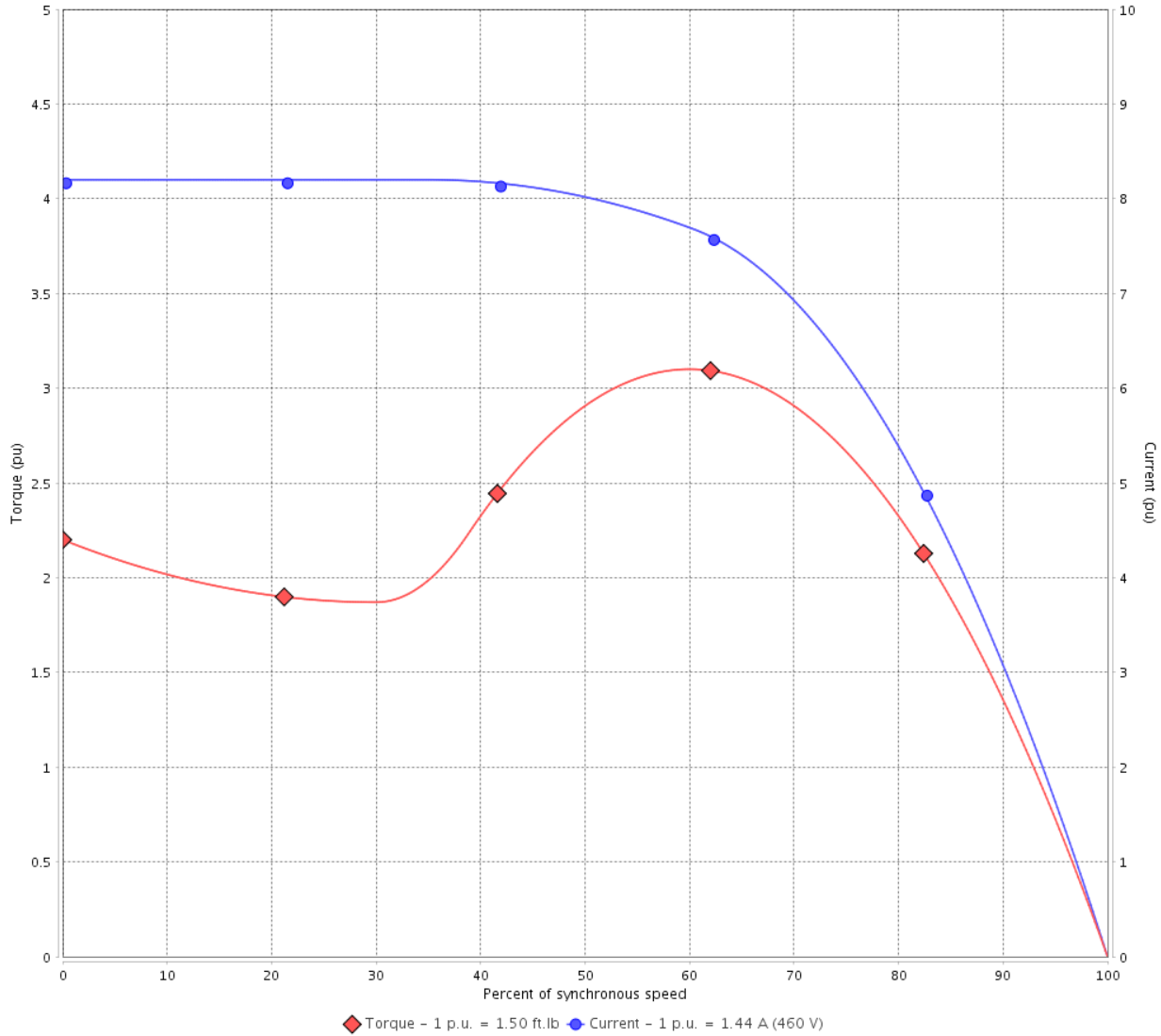

Performance : 230/460 V 60 Hz 2P

Rated current : 2.88/1.44 A  
 LRC : 8.2  
 Rated torque : 1.50 ft.lb  
 Locked rotor torque : 320 %  
 Breakdown torque : 400 %  
 Rated speed : 3500 rpm

Moment of inertia (J) : 0.0332 sq.ft.lb  
 Duty cycle : Cont.(S1)  
 Insulation class : F  
 Service factor : 1.25  
 Temperature rise : 80 K

Locked rotor time : 39s (cold) 22s (hot)

Rev.	Changes Summary	Performed	Checked	Date
Performed by			Page 2 / 36	Revision
Checked by				
Date	11/04/2022			

# TORQUE AND CURRENT VS SPEED CURVE



## Three Phase Induction Motor - Squirrel Cage

Customer :

Product line : NEMA Premium Efficiency Three-Phase

Product code : 12821880

Catalog # : 00136ET3ER143TC-W22

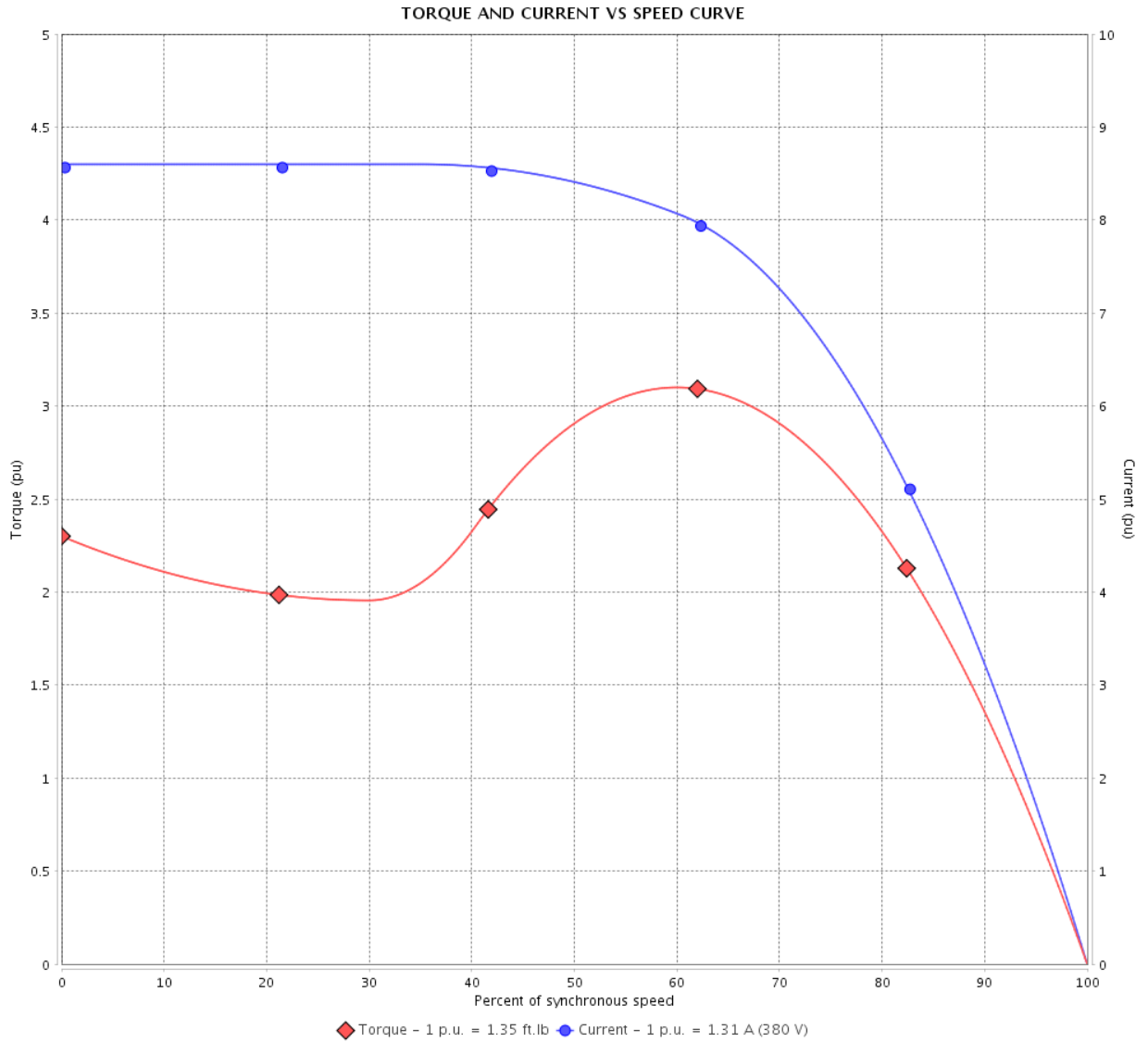

Performance : 380 V 50 Hz 2P IE4

Rated current : 1.31 A  
 LRC : 8.6  
 Rated torque : 1.35 ft.lb  
 Locked rotor torque : 330 %  
 Breakdown torque : 400 %  
 Rated speed : 2910 rpm

Moment of inertia (J) : 0.0332 sq.ft.lb  
 Duty cycle : Cont.(S1)  
 Insulation class : F  
 Service factor : 1.25  
 Temperature rise : 80 K

Locked rotor time : 27s (cold) 15s (hot)

Rev.	Changes Summary	Performed	Checked	Date
Performed by			Page 3 / 36	Revision
Checked by				
Date	11/04/2022			

# TORQUE AND CURRENT VS SPEED CURVE

Three Phase Induction Motor - Squirrel Cage



Customer :

Product line : NEMA Premium Efficiency Three-Phase

Product code : 12821880

Catalog # : 00136ET3ER143TC-W22

TORQUE AND CURRENT VS SPEED CURVE

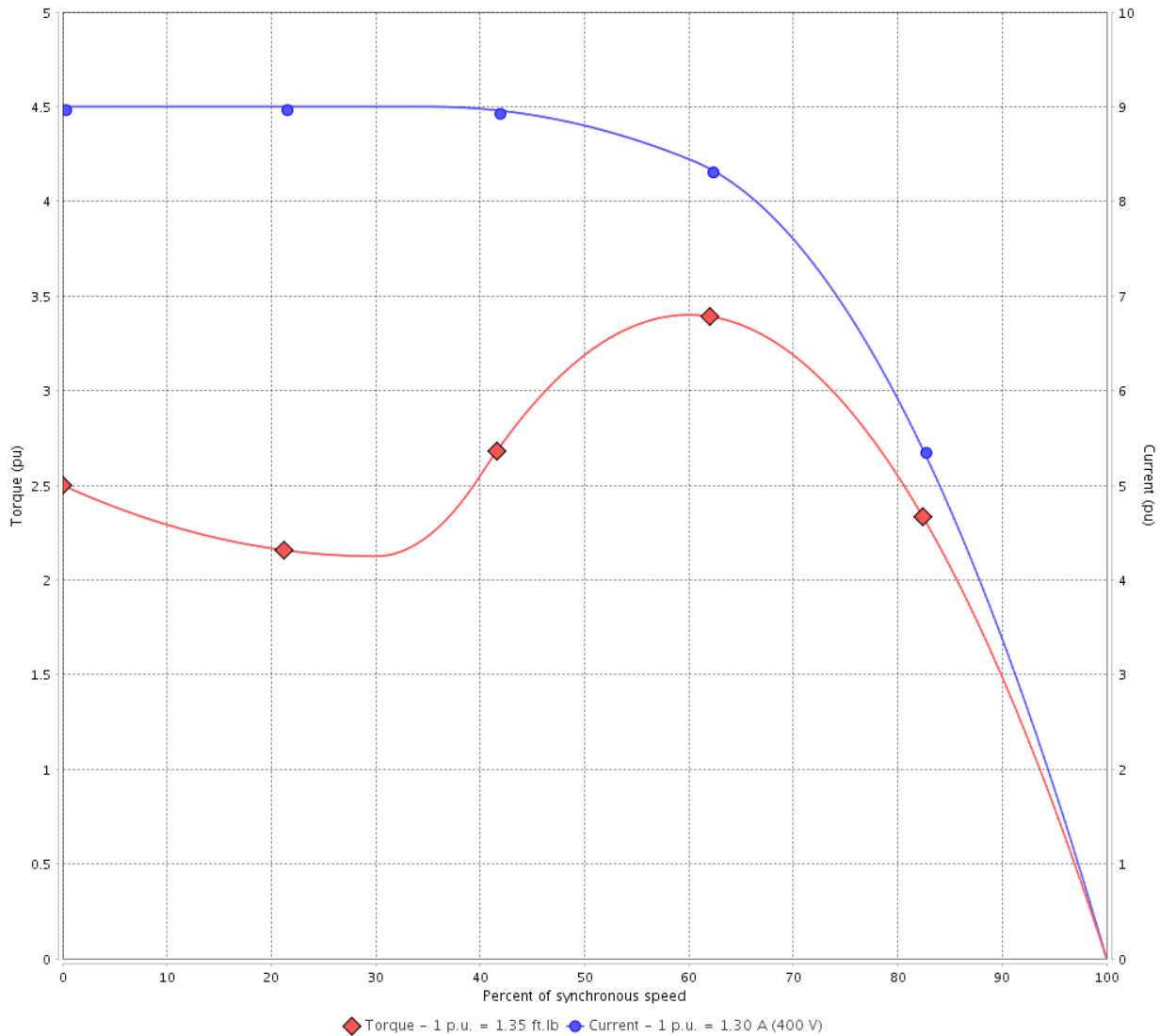

Performance : 400 V 50 Hz 2P IE4

Rated current	: 1.30 A	Moment of inertia (J)	: 0.0332 sq.ft.lb
LRC	: 9.0	Duty cycle	: Cont.(S1)
Rated torque	: 1.35 ft.lb	Insulation class	: F
Locked rotor torque	: 370 %	Service factor	: 1.25
Breakdown torque	: 450 %	Temperature rise	: 80 K
Rated speed	: 2920 rpm		

Locked rotor time : 27s (cold) 15s (hot)

Rev.	Changes Summary	Performed	Checked	Date
Performed by			Page 4 / 36	Revision
Checked by				
Date	11/04/2022			

# TORQUE AND CURRENT VS SPEED CURVE



## Three Phase Induction Motor - Squirrel Cage

Customer :

Product line : NEMA Premium Efficiency Three-Phase  
 Product code : 12821880  
 Catalog # : 00136ET3ER143TC-W22

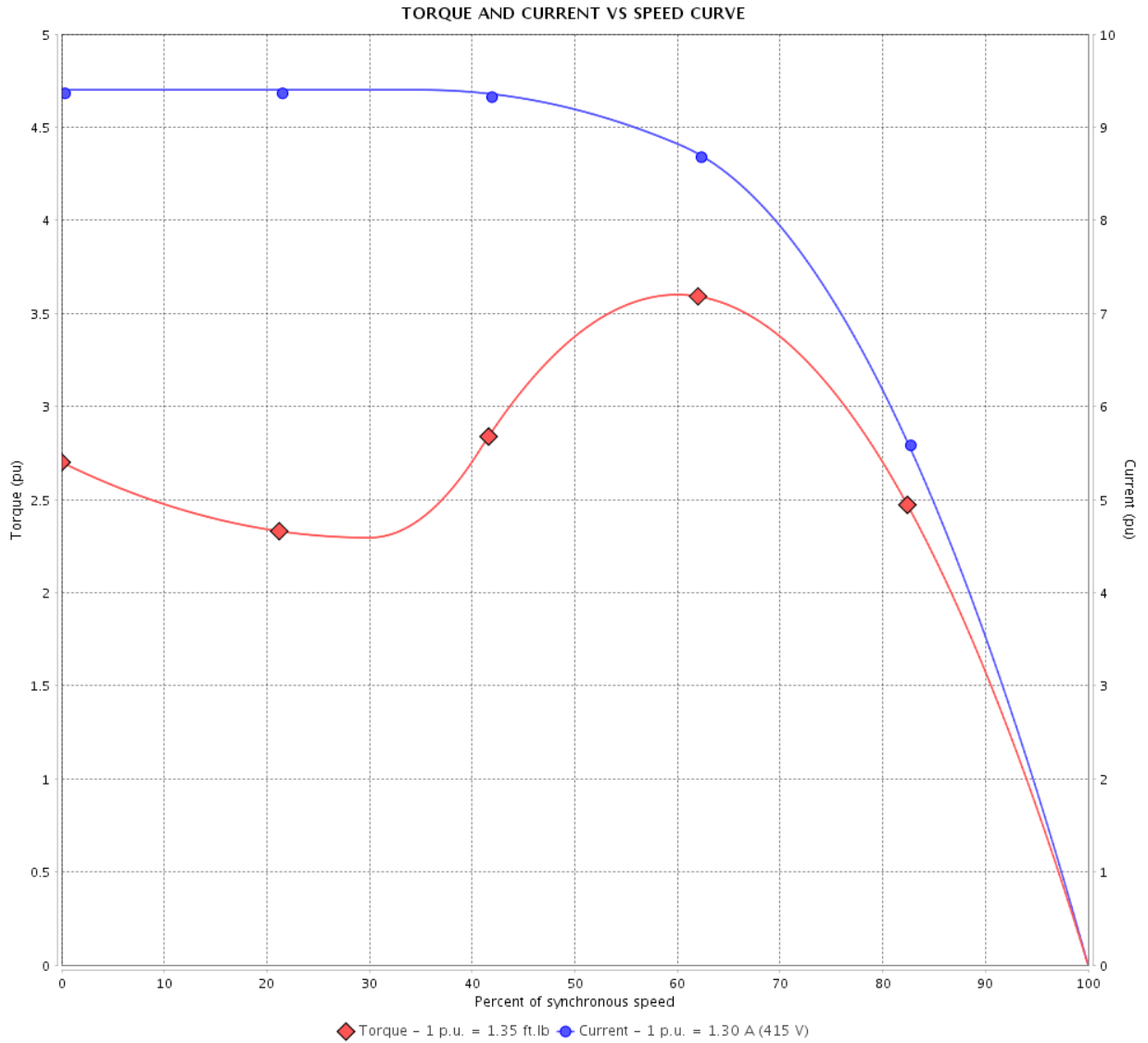

Performance : 415 V 50 Hz 2P IE4

Rated current : 1.30 A	Moment of inertia (J) : 0.0332 sq.ft.lb
LRC : 9.4	Duty cycle : Cont.(S1)
Rated torque : 1.35 ft.lb	Insulation class : F
Locked rotor torque : 409 %	Service factor : 1.25
Breakdown torque : 500 %	Temperature rise : 80 K
Rated speed : 2925 rpm	

Locked rotor time : 27s (cold) 15s (hot)

Rev.	Changes Summary	Performed	Checked	Date
Performed by			Page 5 / 36	Revision
Checked by				
Date	11/04/2022			

# TORQUE AND CURRENT VS SPEED CURVE

## Three Phase Induction Motor - Squirrel Cage



Customer :

Product line : NEMA Premium Efficiency Three-Phase

Product code : 12821880

Catalog # : 00136ET3ER143TC-W22

TORQUE AND CURRENT VS SPEED CURVE

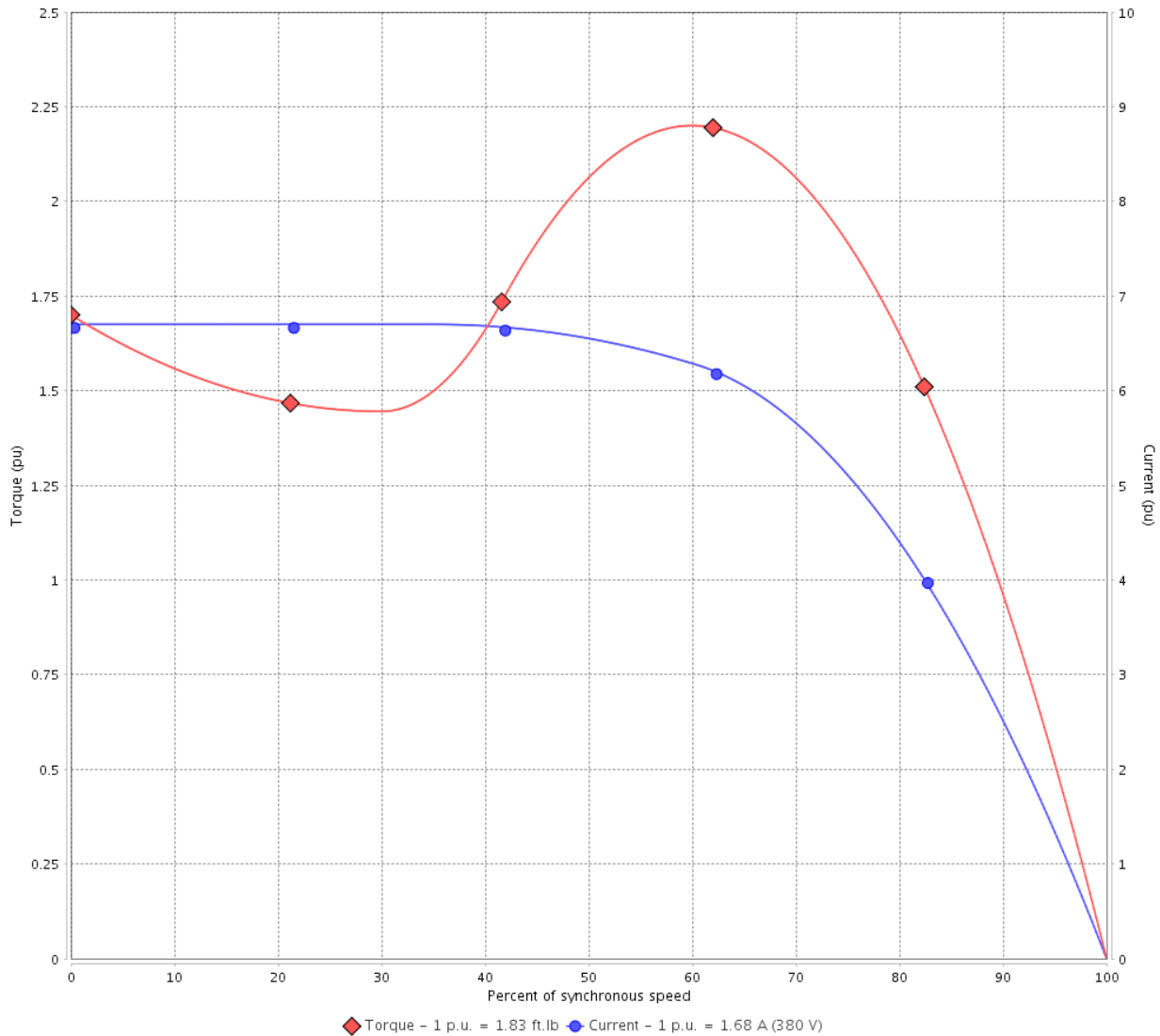

Performance : 380 V 50 Hz 2P IE2

Rated current	: 1.68 A	Moment of inertia (J)	: 0.0332 sq.ft.lb
LRC	: 6.7	Duty cycle	: Cont.(S1)
Rated torque	: 1.83 ft.lb	Insulation class	: F
Locked rotor torque	: 240 %	Service factor	: 1.25
Breakdown torque	: 280 %	Temperature rise	: 80 K
Rated speed	: 2865 rpm		

Locked rotor time : 27s (cold) 15s (hot)

Rev.	Changes Summary	Performed	Checked	Date
Performed by			Page 6 / 36	Revision
Checked by				
Date	11/04/2022			

# TORQUE AND CURRENT VS SPEED CURVE



## Three Phase Induction Motor - Squirrel Cage

Customer :

Product line : NEMA Premium Efficiency Three-Phase  
 Product code : 12821880  
 Catalog # : 00136ET3ER143TC-W22

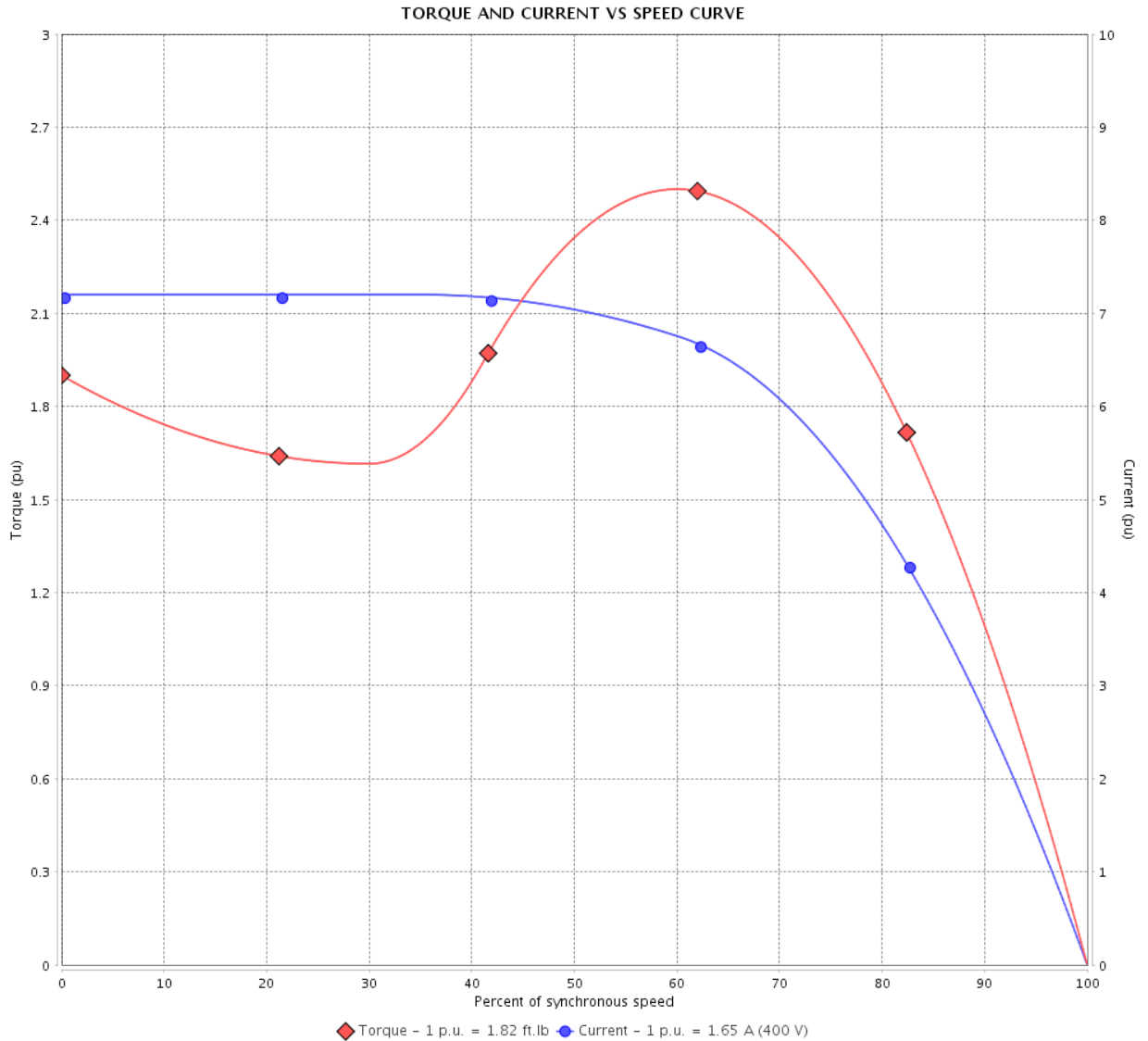

Performance : 400 V 50 Hz 2P IE2

Rated current	: 1.65 A	Moment of inertia (J)	: 0.0332 sq.ft.lb
LRC	: 7.2	Duty cycle	: Cont.(S1)
Rated torque	: 1.82 ft.lb	Insulation class	: F
Locked rotor torque	: 270 %	Service factor	: 1.25
Breakdown torque	: 320 %	Temperature rise	: 80 K
Rated speed	: 2880 rpm		

Locked rotor time : 27s (cold) 15s (hot)

Rev.	Changes Summary	Performed	Checked	Date
Performed by			Page 7 / 36	Revision
Checked by				
Date	11/04/2022			

# TORQUE AND CURRENT VS SPEED CURVE

## Three Phase Induction Motor - Squirrel Cage



Customer :

Product line : NEMA Premium Efficiency Three-Phase

Product code : 12821880

Catalog # : 00136ET3ER143TC-W22

TORQUE AND CURRENT VS SPEED CURVE

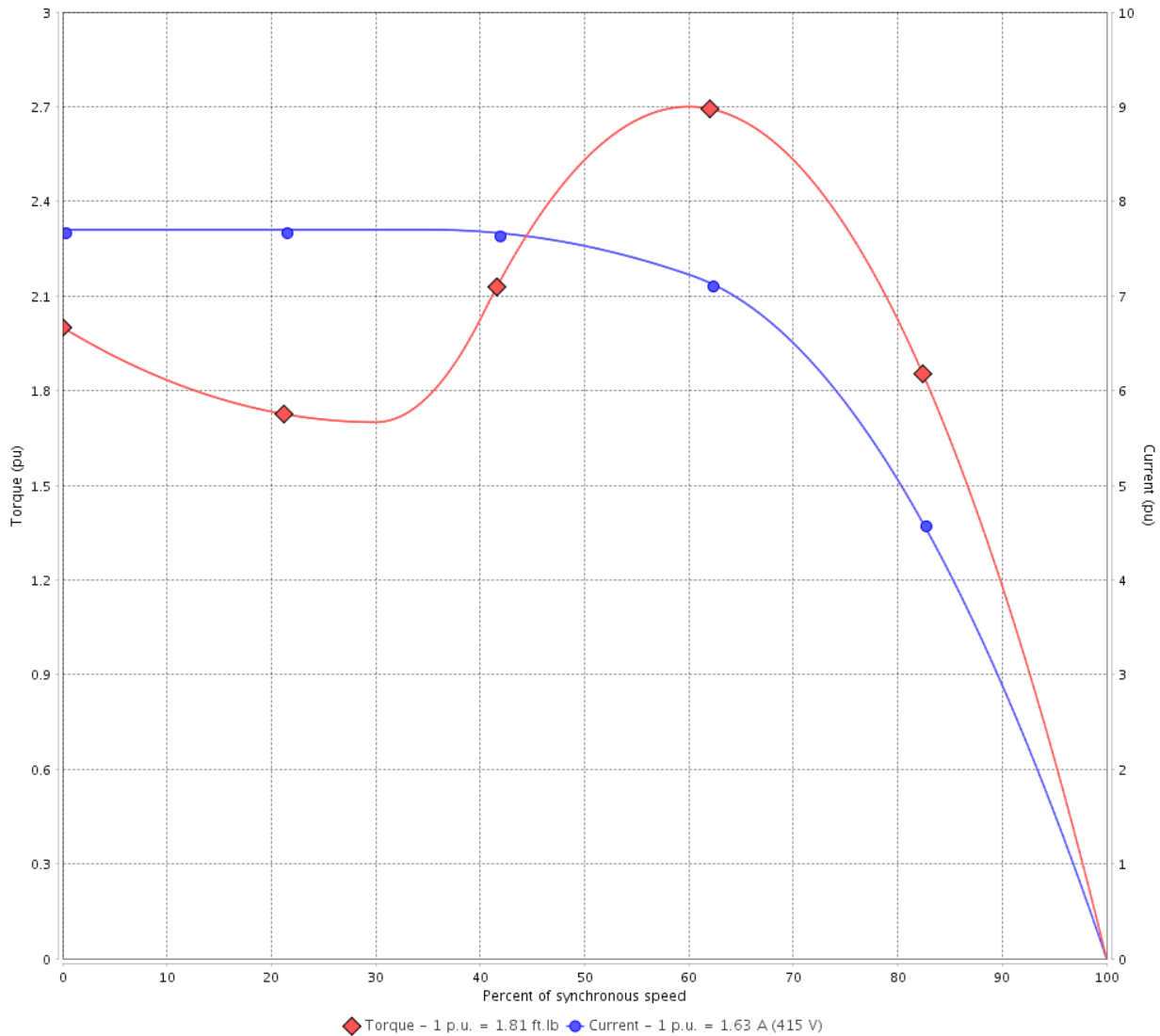

Performance : 415 V 50 Hz 2P IE2

Rated current	: 1.63 A	Moment of inertia (J)	: 0.0332 sq.ft.lb
LRC	: 7.7	Duty cycle	: Cont.(S1)
Rated torque	: 1.81 ft.lb	Insulation class	: F
Locked rotor torque	: 300 %	Service factor	: 1.25
Breakdown torque	: 350 %	Temperature rise	: 80 K
Rated speed	: 2895 rpm		

Locked rotor time : 27s (cold) 15s (hot)

Rev.	Changes Summary	Performed	Checked	Date
Performed by			Page 8 / 36	Revision
Checked by				
Date	11/04/2022			



# LOAD PERFORMANCE CURVE

## Three Phase Induction Motor - Squirrel Cage



Customer :

Product line : NEMA Premium Efficiency Three-Phase

Product code : 12821880

Catalog # : 00136ET3ER143TC-W22

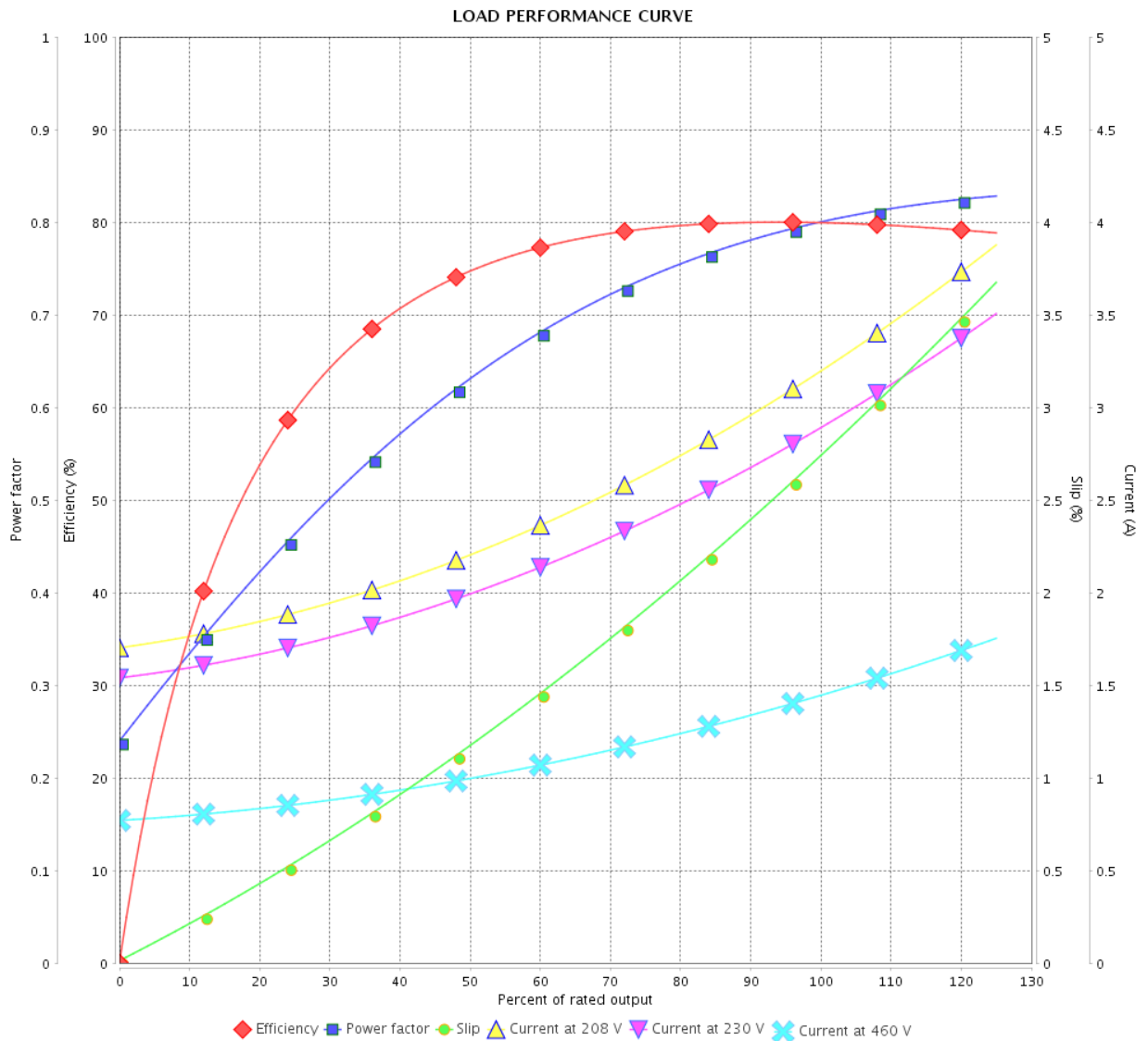

Performance : 230/460 V 60 Hz 2P

Rated current : 2.88/1.44 A  
 LRC : 8.2  
 Rated torque : 1.50 ft.lb  
 Locked rotor torque : 320 %  
 Breakdown torque : 400 %  
 Rated speed : 3500 rpm

Moment of inertia (J) : 0.0332 sq.ft.lb  
 Duty cycle : Cont.(S1)  
 Insulation class : F  
 Service factor : 1.25  
 Temperature rise : 80 K

Rev.	Changes Summary	Performed	Checked	Date
Performed by		Page		Revision
Checked by		9 / 36		
Date		11/04/2022		

# LOAD PERFORMANCE CURVE

Three Phase Induction Motor - Squirrel Cage



Customer :

Product line : NEMA Premium Efficiency Three-Phase

Product code : 12821880

Catalog # : 00136ET3ER143TC-W22

LOAD PERFORMANCE CURVE

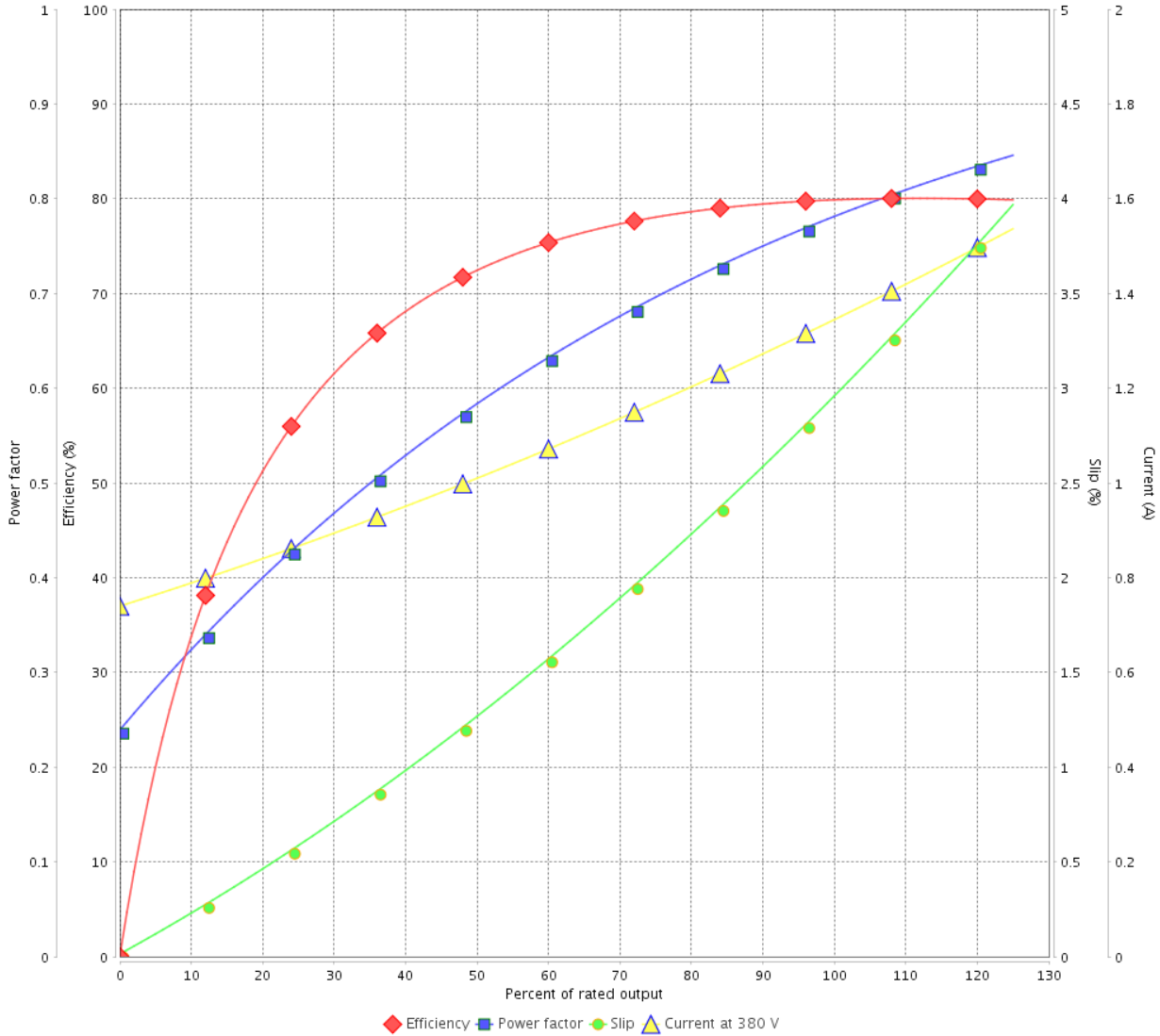

Performance : 380 V 50 Hz 2P IE4

Rated current : 1.31 A  
 LRC : 8.6  
 Rated torque : 1.35 ft.lb  
 Locked rotor torque : 330 %  
 Breakdown torque : 400 %  
 Rated speed : 2910 rpm

Moment of inertia (J) : 0.0332 sq.ft.lb  
 Duty cycle : Cont.(S1)  
 Insulation class : F  
 Service factor : 1.25  
 Temperature rise : 80 K

Rev.	Changes Summary	Performed	Checked	Date
Performed by		Page		Revision
Checked by		10 / 36		
Date	11/04/2022			

# LOAD PERFORMANCE CURVE

## Three Phase Induction Motor - Squirrel Cage



Customer :

Product line : NEMA Premium Efficiency Three-Phase

Product code : 12821880

Catalog # : 00136ET3ER143TC-W22

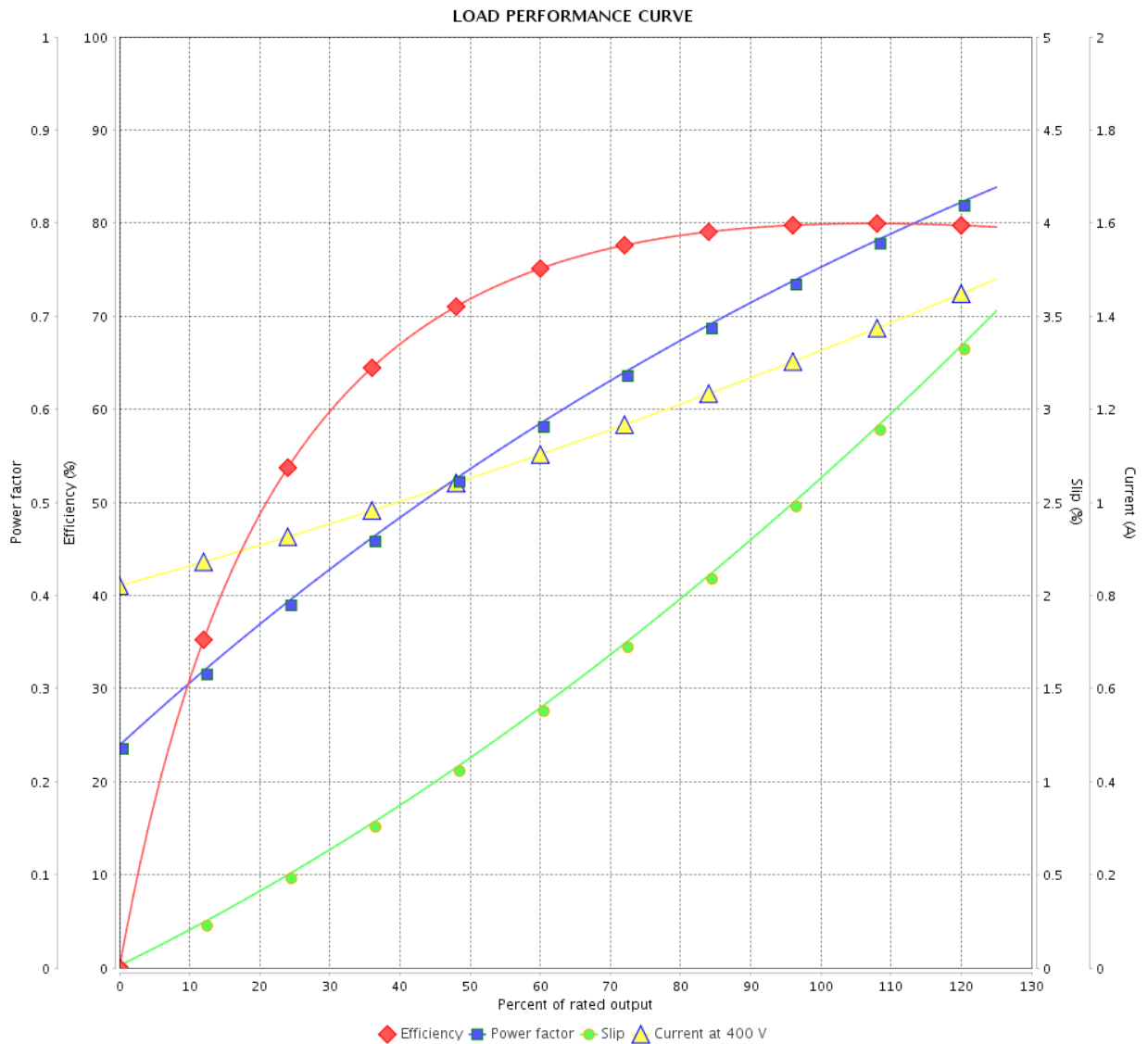

Performance : 400 V 50 Hz 2P IE4

Rated current : 1.30 A  
 LRC : 9.0  
 Rated torque : 1.35 ft.lb  
 Locked rotor torque : 370 %  
 Breakdown torque : 450 %  
 Rated speed : 2920 rpm

Moment of inertia (J) : 0.0332 sq.ft.lb  
 Duty cycle : Cont.(S1)  
 Insulation class : F  
 Service factor : 1.25  
 Temperature rise : 80 K

Rev.	Changes Summary	Performed	Checked	Date
Performed by		Page		Revision
Checked by		11 / 36		
Date		11/04/2022		

# LOAD PERFORMANCE CURVE

Three Phase Induction Motor - Squirrel Cage



Customer :

Product line : NEMA Premium Efficiency Three-Phase

Product code : 12821880

Catalog # : 00136ET3ER143TC-W22

LOAD PERFORMANCE CURVE

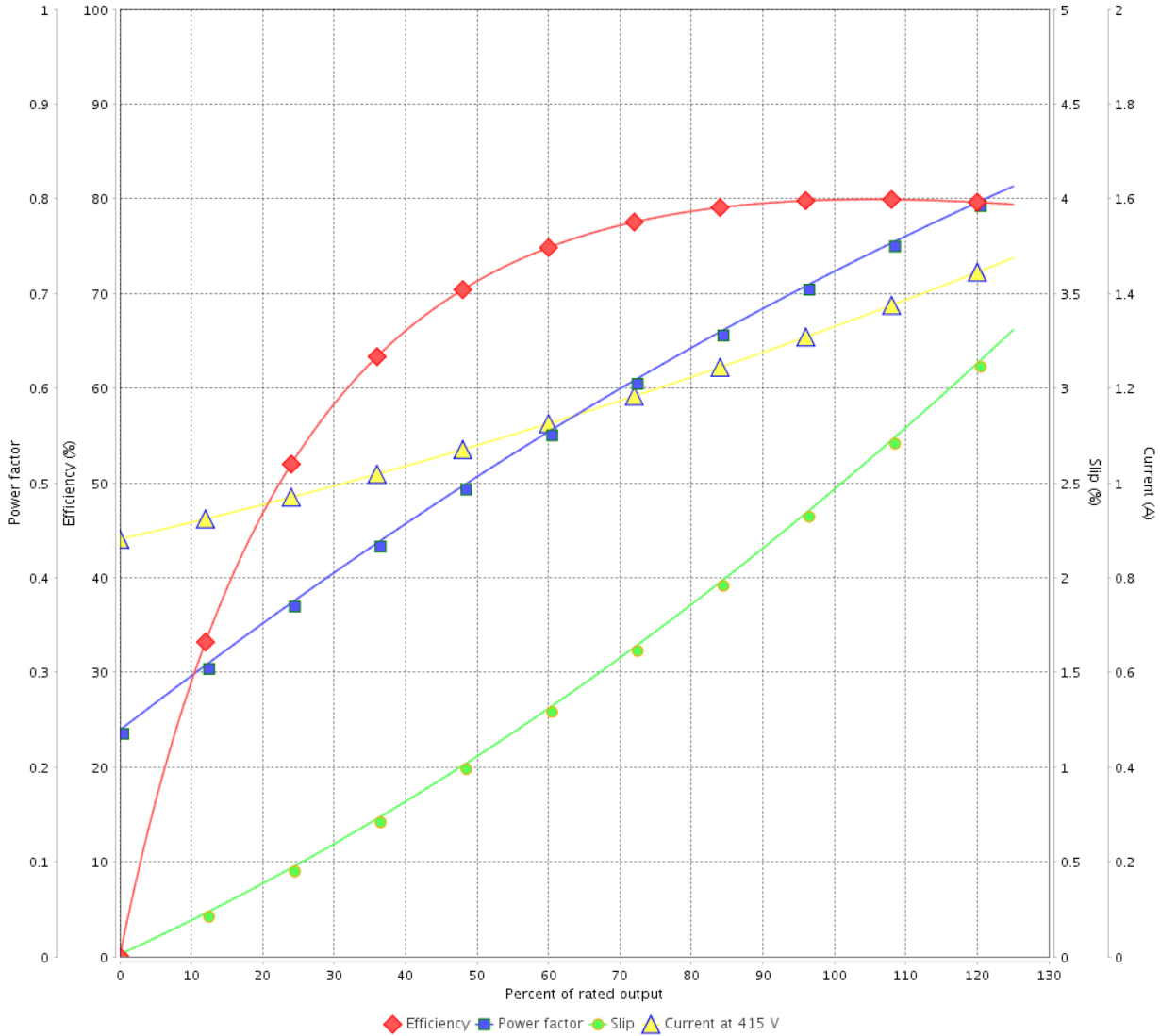

Performance : 415 V 50 Hz 2P IE4

Rated current : 1.30 A  
 LRC : 9.4  
 Rated torque : 1.35 ft.lb  
 Locked rotor torque : 409 %  
 Breakdown torque : 500 %  
 Rated speed : 2925 rpm

Moment of inertia (J) : 0.0332 sq.ft.lb  
 Duty cycle : Cont.(S1)  
 Insulation class : F  
 Service factor : 1.25  
 Temperature rise : 80 K

Rev.	Changes Summary	Performed	Checked	Date
Performed by			Page 12 / 36	Revision
Checked by				
Date	11/04/2022			

# LOAD PERFORMANCE CURVE

## Three Phase Induction Motor - Squirrel Cage



Customer : \_\_\_\_\_

Product line : NEMA Premium Efficiency Three-Phase

Product code : 12821880

Catalog # : 00136ET3ER143TC-W22

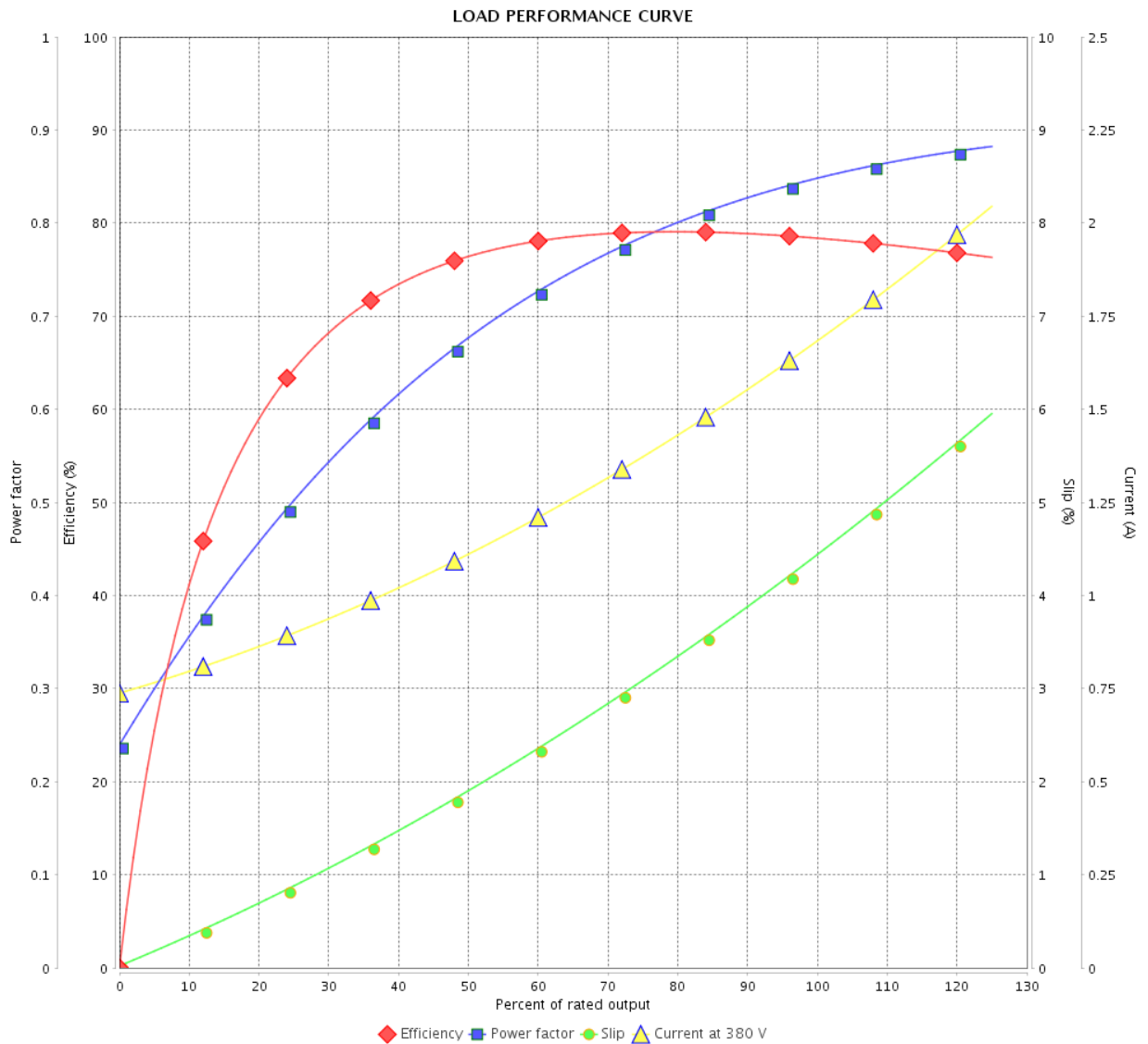

Performance : 380 V 50 Hz 2P IE2

Rated current : 1.68 A  
 LRC : 6.7  
 Rated torque : 1.83 ft.lb  
 Locked rotor torque : 240 %  
 Breakdown torque : 280 %  
 Rated speed : 2865 rpm

Moment of inertia (J) : 0.0332 sq.ft.lb  
 Duty cycle : Cont.(S1)  
 Insulation class : F  
 Service factor : 1.25  
 Temperature rise : 80 K

Rev.	Changes Summary	Performed	Checked	Date
Performed by		Page		Revision
Checked by		13 / 36		
Date		11/04/2022		

# LOAD PERFORMANCE CURVE

Three Phase Induction Motor - Squirrel Cage



Customer :

Product line : NEMA Premium Efficiency Three-Phase

Product code : 12821880

Catalog # : 00136ET3ER143TC-W22

LOAD PERFORMANCE CURVE

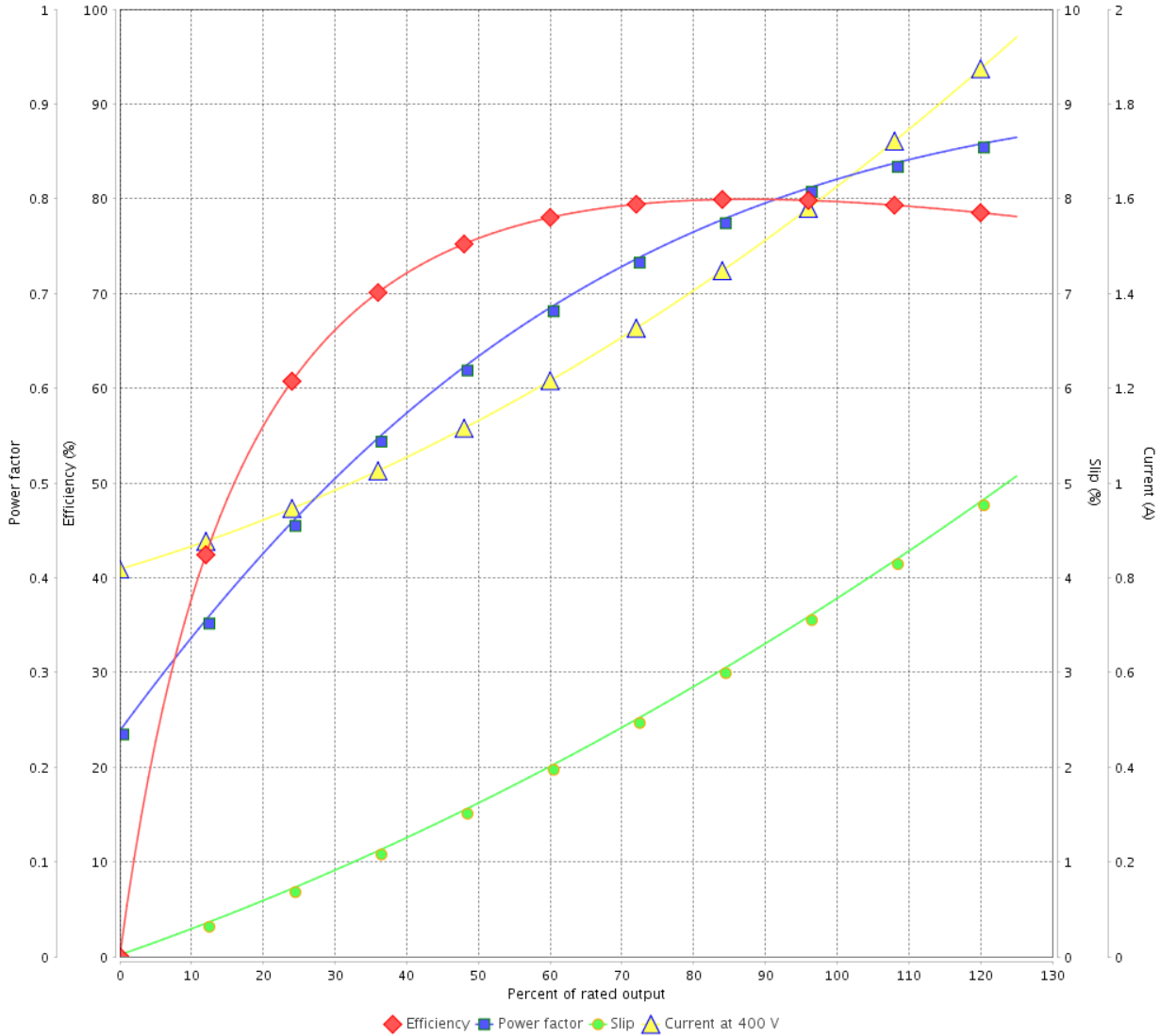

Performance : 400 V 50 Hz 2P IE2

Rated current : 1.65 A  
 LRC : 7.2  
 Rated torque : 1.82 ft.lb  
 Locked rotor torque : 270 %  
 Breakdown torque : 320 %  
 Rated speed : 2880 rpm

Moment of inertia (J) : 0.0332 sq.ft.lb  
 Duty cycle : Cont.(S1)  
 Insulation class : F  
 Service factor : 1.25  
 Temperature rise : 80 K

Rev.	Changes Summary	Performed	Checked	Date
Performed by			Page 14 / 36	Revision
Checked by				
Date	11/04/2022			

# LOAD PERFORMANCE CURVE

## Three Phase Induction Motor - Squirrel Cage



Customer :

Product line : NEMA Premium Efficiency Three-Phase

Product code : 12821880

Catalog # : 00136ET3ER143TC-W22

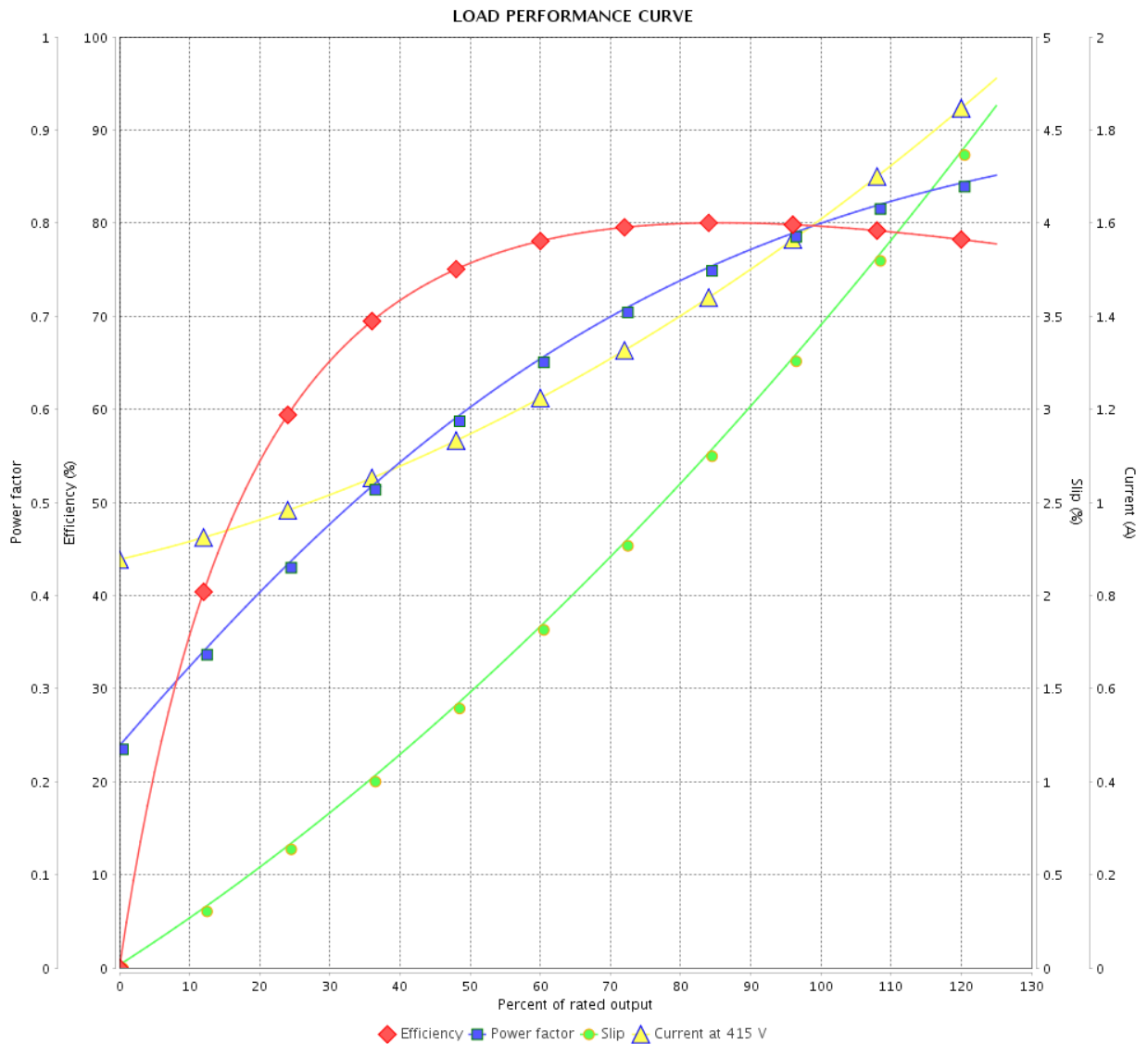

Performance : 415 V 50 Hz 2P IE2

Rated current : 1.63 A  
 LRC : 7.7  
 Rated torque : 1.81 ft.lb  
 Locked rotor torque : 300 %  
 Breakdown torque : 350 %  
 Rated speed : 2895 rpm

Moment of inertia (J) : 0.0332 sq.ft.lb  
 Duty cycle : Cont.(S1)  
 Insulation class : F  
 Service factor : 1.25  
 Temperature rise : 80 K

Rev.	Changes Summary	Performed	Checked	Date
Performed by		Page		Revision
Checked by		15 / 36		
Date		11/04/2022		

# THERMAL LIMIT CURVE



## Three Phase Induction Motor - Squirrel Cage

Customer :

Product line : NEMA Premium Efficiency Three-Phase  
Product code : 12821880  
Catalog # : 00136ET3ER143TC-W22

Performance : 230/460 V 60 Hz 2P

Rated current : 2.88/1.44 A	Moment of inertia (J) : 0.0332 sq.ft.lb
LRC : 8.2	Duty cycle : Cont.(S1)
Rated torque : 1.50 ft.lb	Insulation class : F
Locked rotor torque : 320 %	Service factor : 1.25
Breakdown torque : 400 %	Temperature rise : 80 K
Rated speed : 3500 rpm	

Heating constant

Cooling constant

Rev.	Changes Summary	Performed	Checked	Date
Performed by				
Checked by			Page	Revision
Date	11/04/2022		16 / 36	



# THERMAL LIMIT CURVE

Three Phase Induction Motor - Squirrel Cage



Customer : \_\_\_\_\_

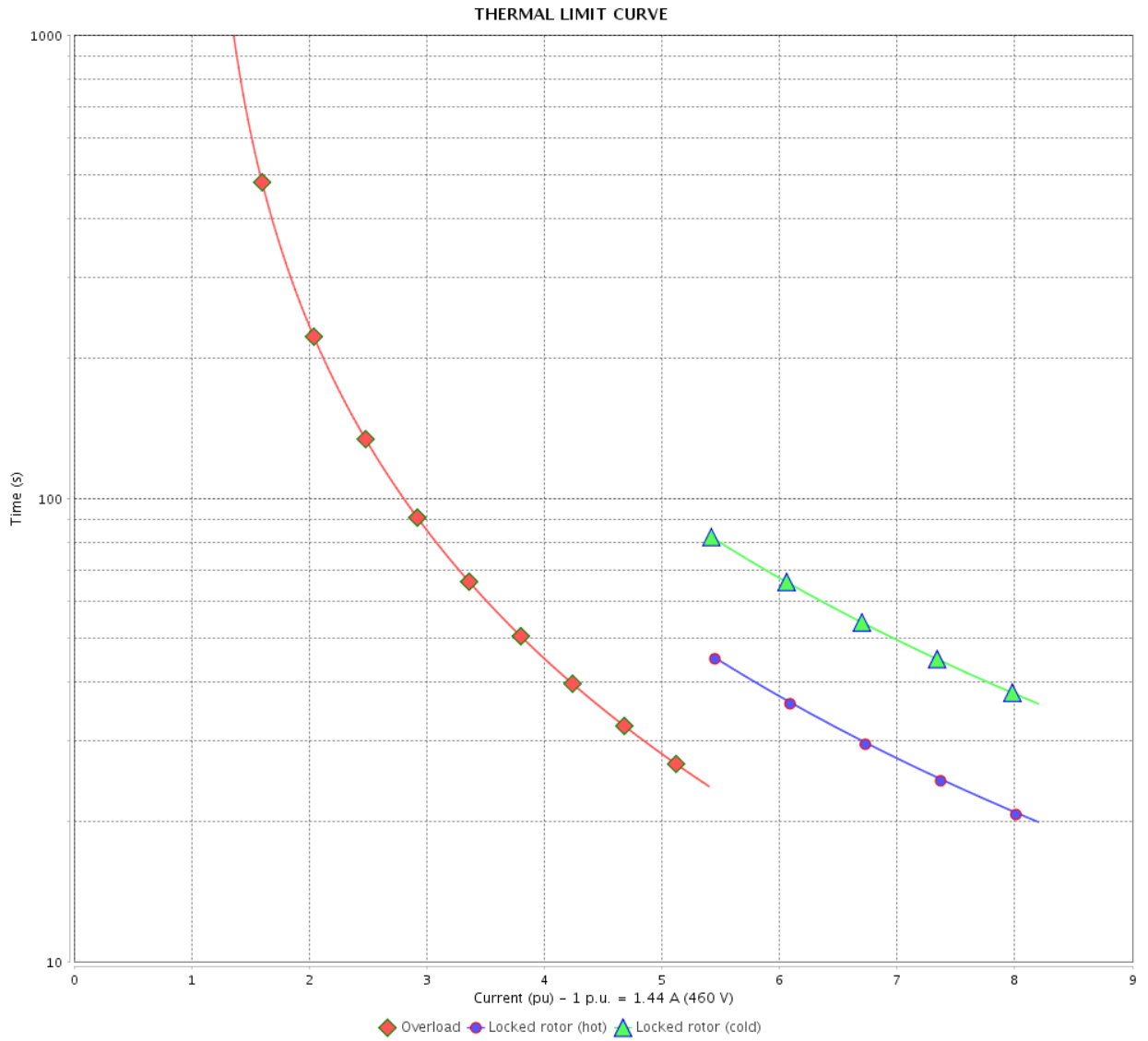

Rev.	Changes Summary	Performed	Checked	Date
Performed by		Page		Revision
Checked by		17 / 36		
Date		11/04/2022		

# THERMAL LIMIT CURVE



## Three Phase Induction Motor - Squirrel Cage

Customer :

Product line : NEMA Premium Efficiency Three-Phase  
 Product code : 12821880  
 Catalog # : 00136ET3ER143TC-W22

Performance : 380 V 50 Hz 2P IE4

Rated current : 1.31 A	Moment of inertia (J) : 0.0332 sq.ft.lb
LRC : 8.6	Duty cycle : Cont.(S1)
Rated torque : 1.35 ft.lb	Insulation class : F
Locked rotor torque : 330 %	Service factor : 1.25
Breakdown torque : 400 %	Temperature rise : 80 K
Rated speed : 2910 rpm	

Heating constant

Cooling constant

Rev.	Changes Summary	Performed	Checked	Date
Performed by			Page 18 / 36	Revision
Checked by				
Date	11/04/2022			

# THERMAL LIMIT CURVE

## Three Phase Induction Motor - Squirrel Cage



Customer : \_\_\_\_\_

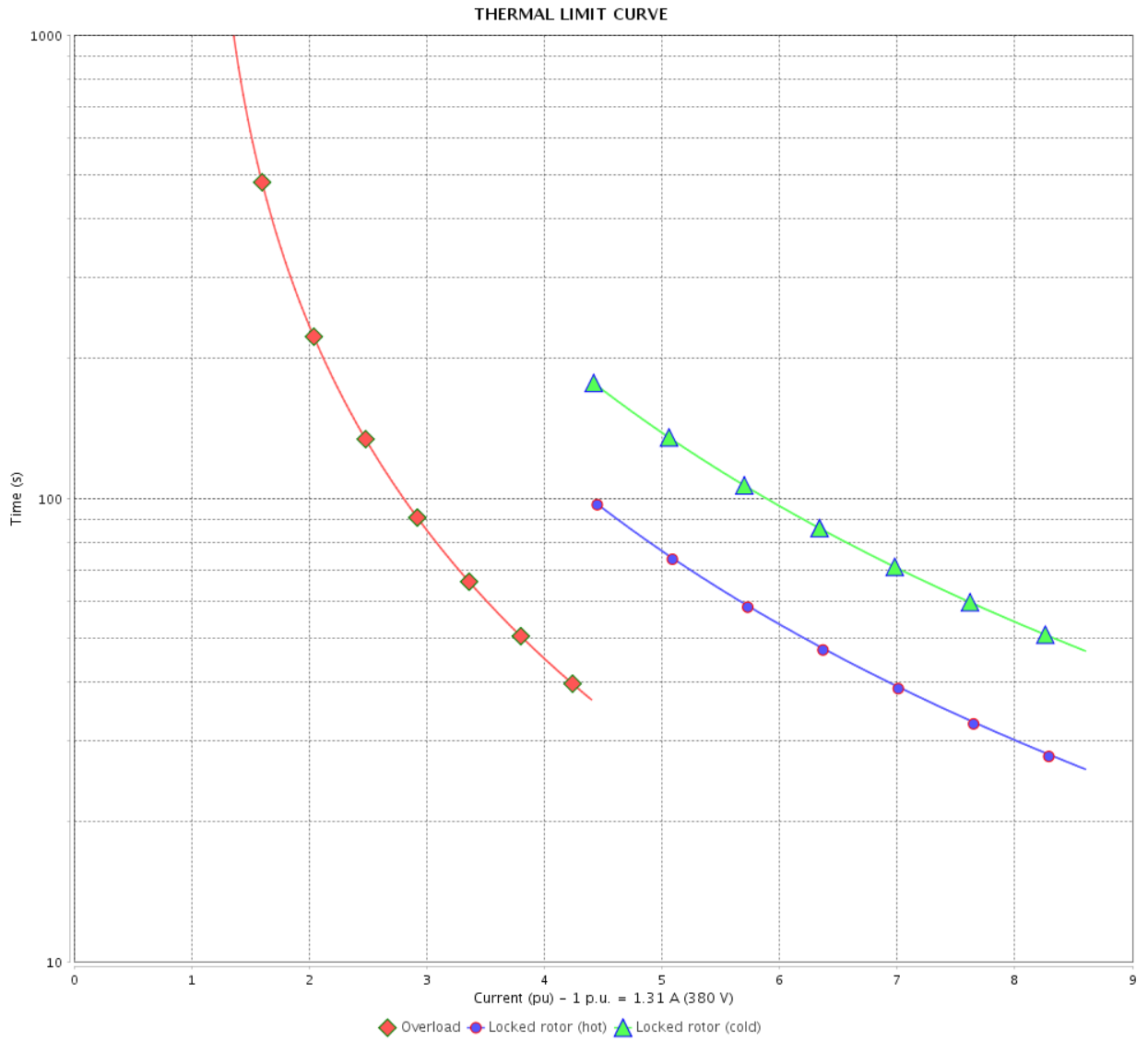

Rev.	Changes Summary	Performed	Checked	Date
Performed by		Page		Revision
Checked by		19 / 36		
Date		11/04/2022		

# THERMAL LIMIT CURVE



## Three Phase Induction Motor - Squirrel Cage

Customer :

Product line : NEMA Premium Efficiency Three-Phase  
Product code : 12821880  
Catalog # : 00136ET3ER143TC-W22

Performance : 400 V 50 Hz 2P IE4

Rated current	: 1.30 A	Moment of inertia (J)	: 0.0332 sq.ft.lb
LRC	: 9.0	Duty cycle	: Cont.(S1)
Rated torque	: 1.35 ft.lb	Insulation class	: F
Locked rotor torque	: 370 %	Service factor	: 1.25
Breakdown torque	: 450 %	Temperature rise	: 80 K
Rated speed	: 2920 rpm		

Heating constant

Cooling constant

Rev.	Changes Summary	Performed	Checked	Date
Performed by				
Checked by			Page	Revision
Date	11/04/2022		20 / 36	

# THERMAL LIMIT CURVE

Three Phase Induction Motor - Squirrel Cage



Customer : \_\_\_\_\_

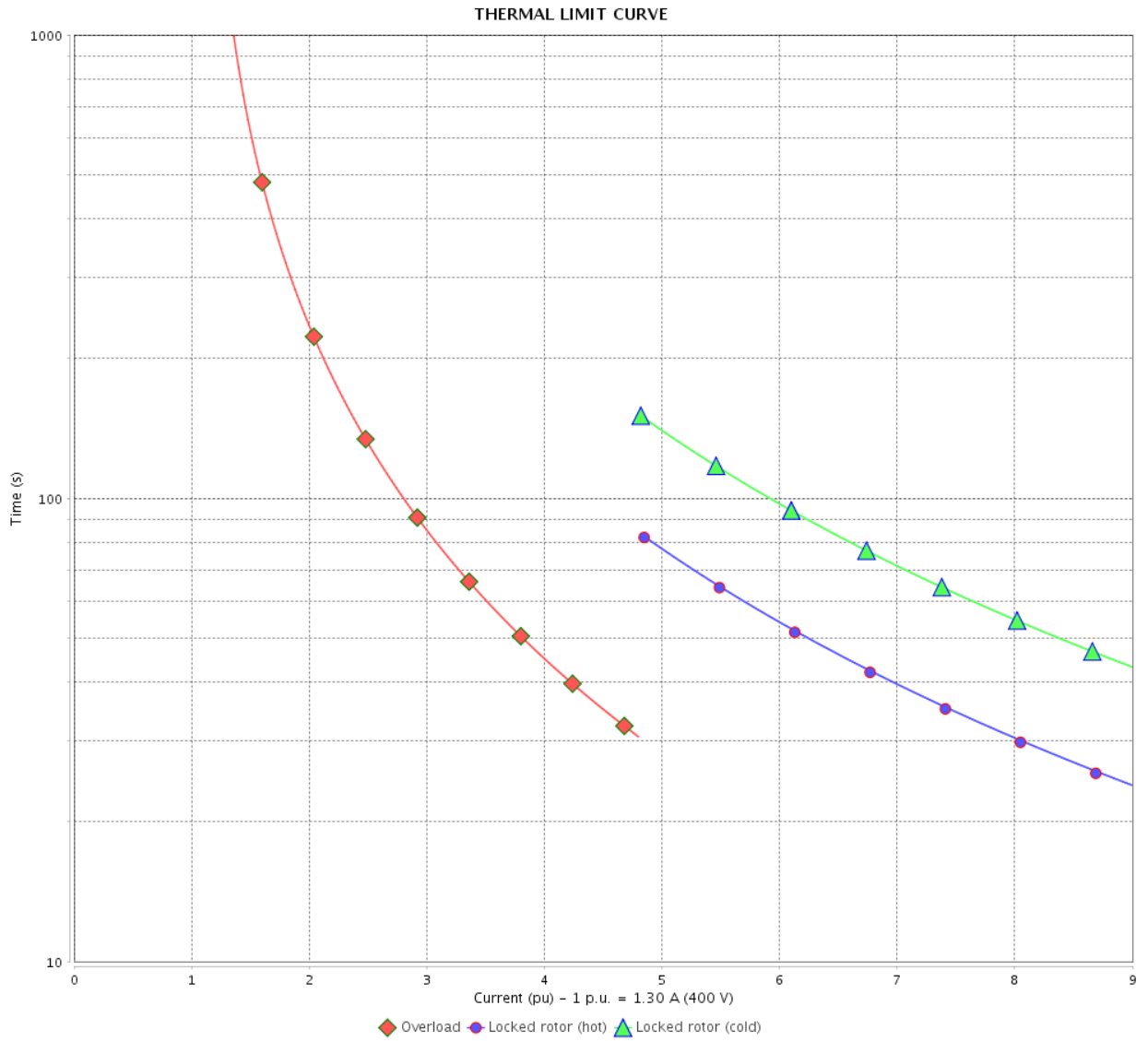

Rev.	Changes Summary	Performed	Checked	Date
Performed by		Page 21 / 36		Revision
Checked by				
Date				

# THERMAL LIMIT CURVE



## Three Phase Induction Motor - Squirrel Cage

Customer :

Product line : NEMA Premium Efficiency Three-Phase  
Product code : 12821880  
Catalog # : 00136ET3ER143TC-W22

Performance : 415 V 50 Hz 2P IE4

Rated current	: 1.30 A	Moment of inertia (J)	: 0.0332 sq.ft.lb
LRC	: 9.4	Duty cycle	: Cont.(S1)
Rated torque	: 1.35 ft.lb	Insulation class	: F
Locked rotor torque	: 409 %	Service factor	: 1.25
Breakdown torque	: 500 %	Temperature rise	: 80 K
Rated speed	: 2925 rpm		

Heating constant

Cooling constant

Rev.	Changes Summary	Performed	Checked	Date
Performed by				
Checked by			Page	Revision
Date	11/04/2022		22 / 36	

# THERMAL LIMIT CURVE

Three Phase Induction Motor - Squirrel Cage



Customer : \_\_\_\_\_

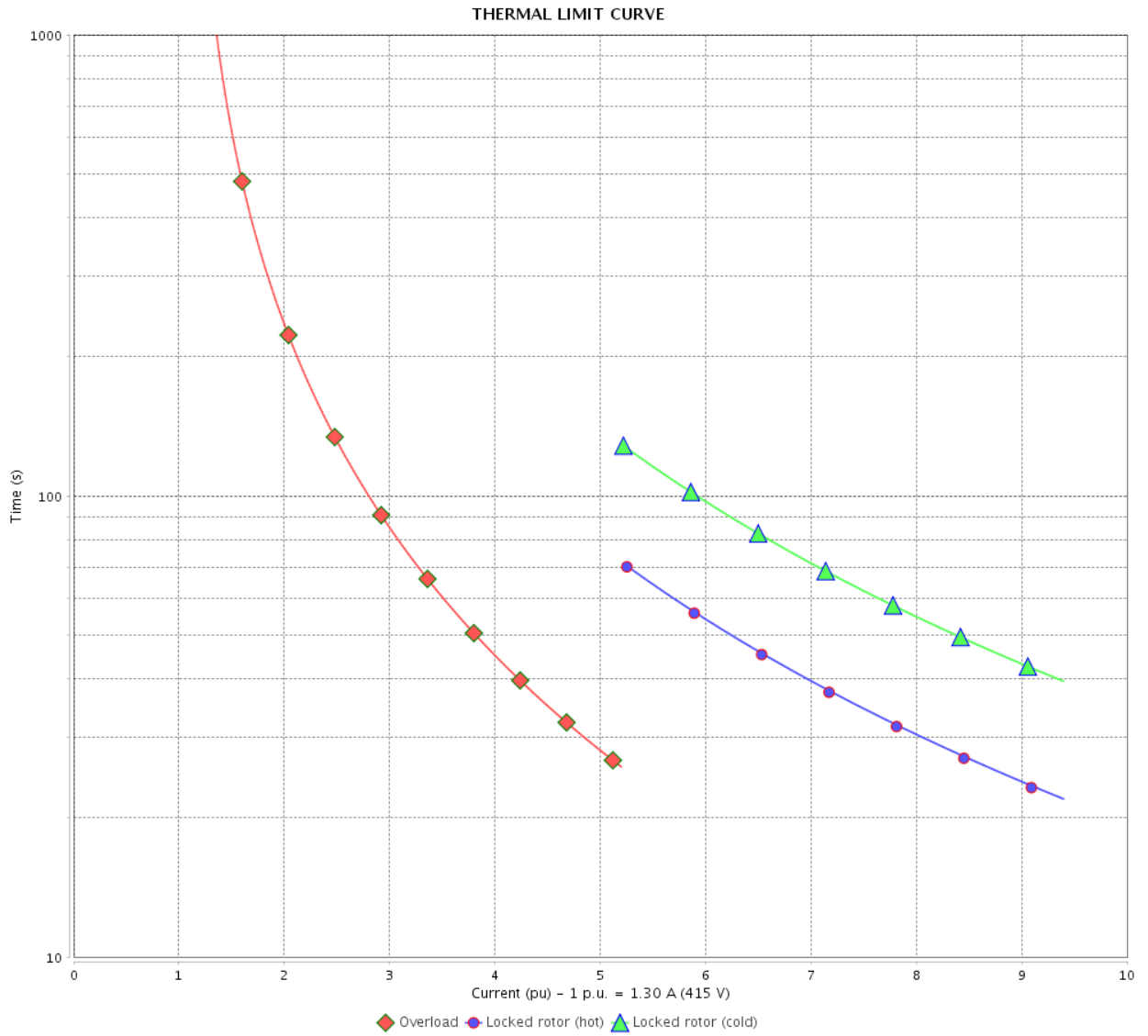

Rev.	Changes Summary	Performed	Checked	Date
Performed by		Page 23 / 36		Revision
Checked by				
Date				

# THERMAL LIMIT CURVE



## Three Phase Induction Motor - Squirrel Cage

Customer :

Product line : NEMA Premium Efficiency Three-Phase  
Product code : 12821880  
Catalog # : 00136ET3ER143TC-W22

Performance : 380 V 50 Hz 2P IE2

Rated current	: 1.68 A	Moment of inertia (J)	: 0.0332 sq.ft.lb
LRC	: 6.7	Duty cycle	: Cont.(S1)
Rated torque	: 1.83 ft.lb	Insulation class	: F
Locked rotor torque	: 240 %	Service factor	: 1.25
Breakdown torque	: 280 %	Temperature rise	: 80 K
Rated speed	: 2865 rpm		

Heating constant

Cooling constant

Rev.	Changes Summary	Performed	Checked	Date
Performed by				
Checked by			Page	Revision
Date	11/04/2022		24 / 36	



# THERMAL LIMIT CURVE

Three Phase Induction Motor - Squirrel Cage



Customer : \_\_\_\_\_

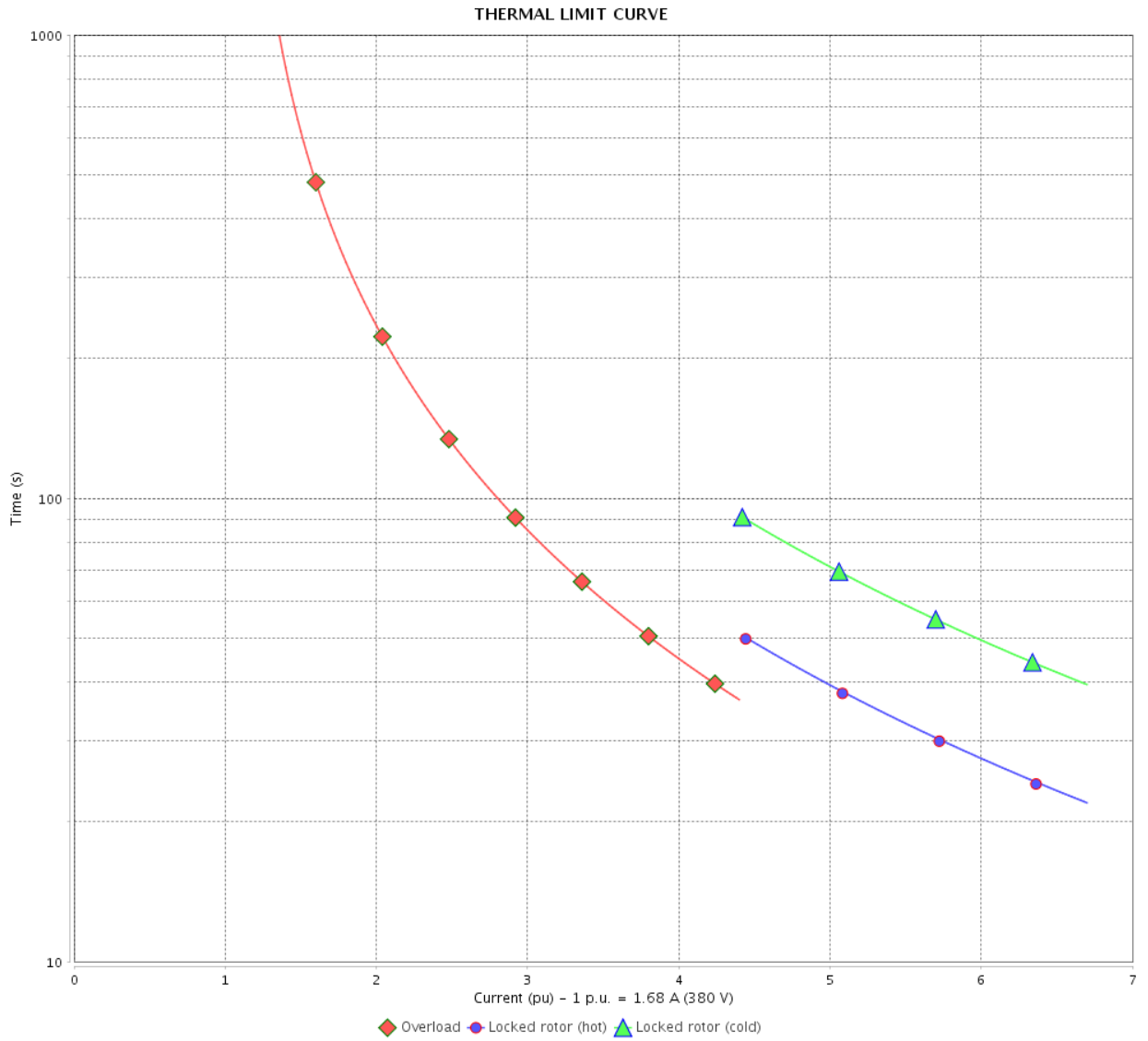

Rev.	Changes Summary	Performed	Checked	Date
Performed by		Page		Revision
Checked by		25 / 36		
Date		11/04/2022		

# THERMAL LIMIT CURVE



## Three Phase Induction Motor - Squirrel Cage

Customer :

Product line : NEMA Premium Efficiency Three-Phase  
Product code : 12821880  
Catalog # : 00136ET3ER143TC-W22

Performance : 400 V 50 Hz 2P IE2

Rated current	: 1.65 A	Moment of inertia (J)	: 0.0332 sq.ft.lb
LRC	: 7.2	Duty cycle	: Cont.(S1)
Rated torque	: 1.82 ft.lb	Insulation class	: F
Locked rotor torque	: 270 %	Service factor	: 1.25
Breakdown torque	: 320 %	Temperature rise	: 80 K
Rated speed	: 2880 rpm		

Heating constant

Cooling constant

Rev.	Changes Summary	Performed	Checked	Date
Performed by				
Checked by				
Date	11/04/2022		Page 26 / 36	Revision

# THERMAL LIMIT CURVE

Three Phase Induction Motor - Squirrel Cage



Customer : \_\_\_\_\_

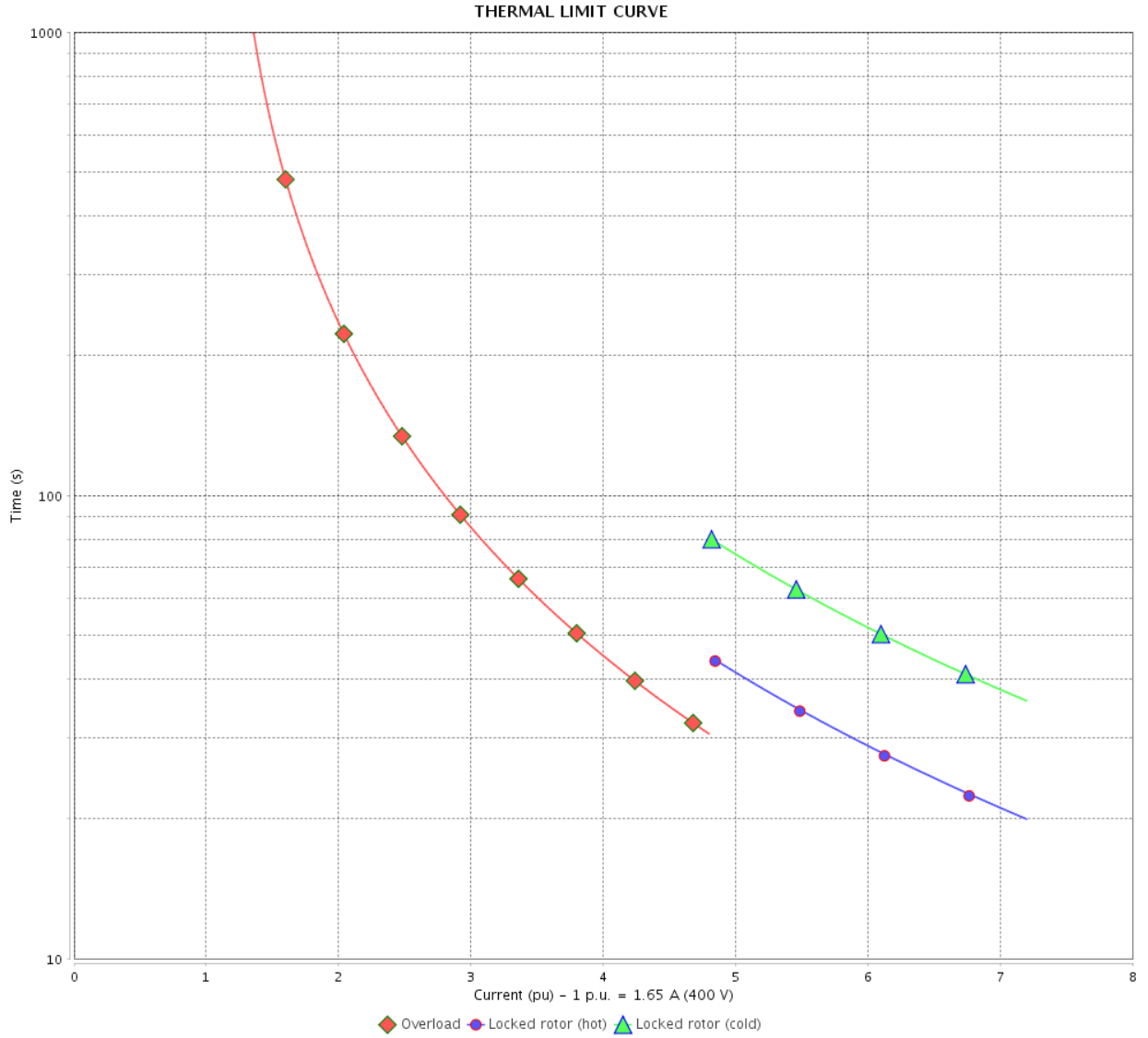

Rev.	Changes Summary	Performed	Checked	Date
Performed by		Page		Revision
Checked by		27 / 36		
Date		11/04/2022		

# THERMAL LIMIT CURVE



## Three Phase Induction Motor - Squirrel Cage

Customer :

Product line : NEMA Premium Efficiency Three-Phase  
Product code : 12821880  
Catalog # : 00136ET3ER143TC-W22

Performance : 415 V 50 Hz 2P IE2

Rated current	: 1.63 A	Moment of inertia (J)	: 0.0332 sq.ft.lb
LRC	: 7.7	Duty cycle	: Cont.(S1)
Rated torque	: 1.81 ft.lb	Insulation class	: F
Locked rotor torque	: 300 %	Service factor	: 1.25
Breakdown torque	: 350 %	Temperature rise	: 80 K
Rated speed	: 2895 rpm		

Heating constant

Cooling constant

Rev.	Changes Summary	Performed	Checked	Date
Performed by				
Checked by			Page	Revision
Date	11/04/2022		28 / 36	

# THERMAL LIMIT CURVE

Three Phase Induction Motor - Squirrel Cage



Customer : \_\_\_\_\_

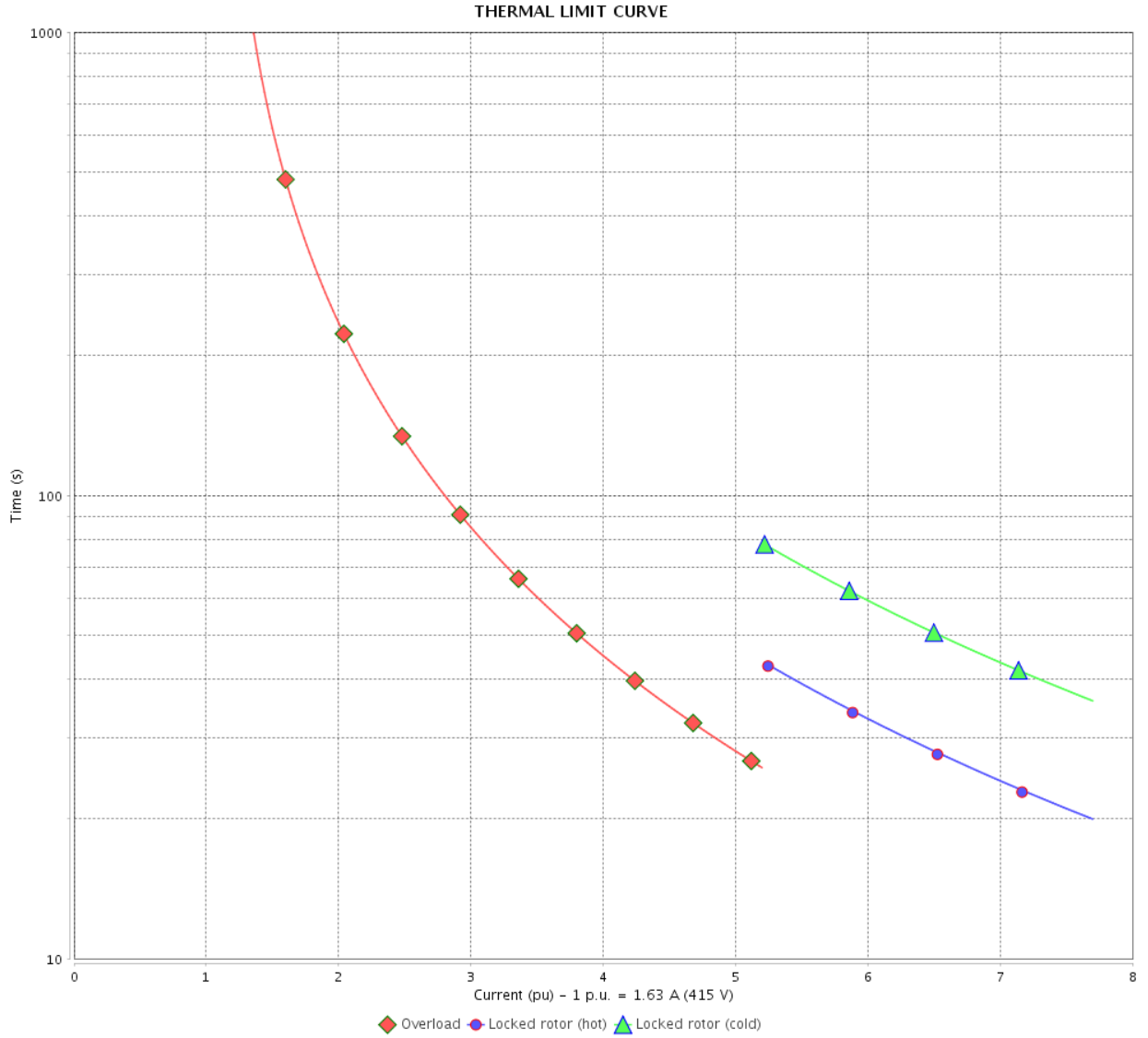

Rev.	Changes Summary	Performed	Checked	Date
Performed by		Page 29 / 36		Revision
Checked by				
Date				

# VFD OPERATION CURVE

Three Phase Induction Motor - Squirrel Cage



Customer : \_\_\_\_\_

Product line : NEMA Premium Efficiency Three-Phase

Product code : 12821880

Catalog # : 00136ET3ER143TC-W22

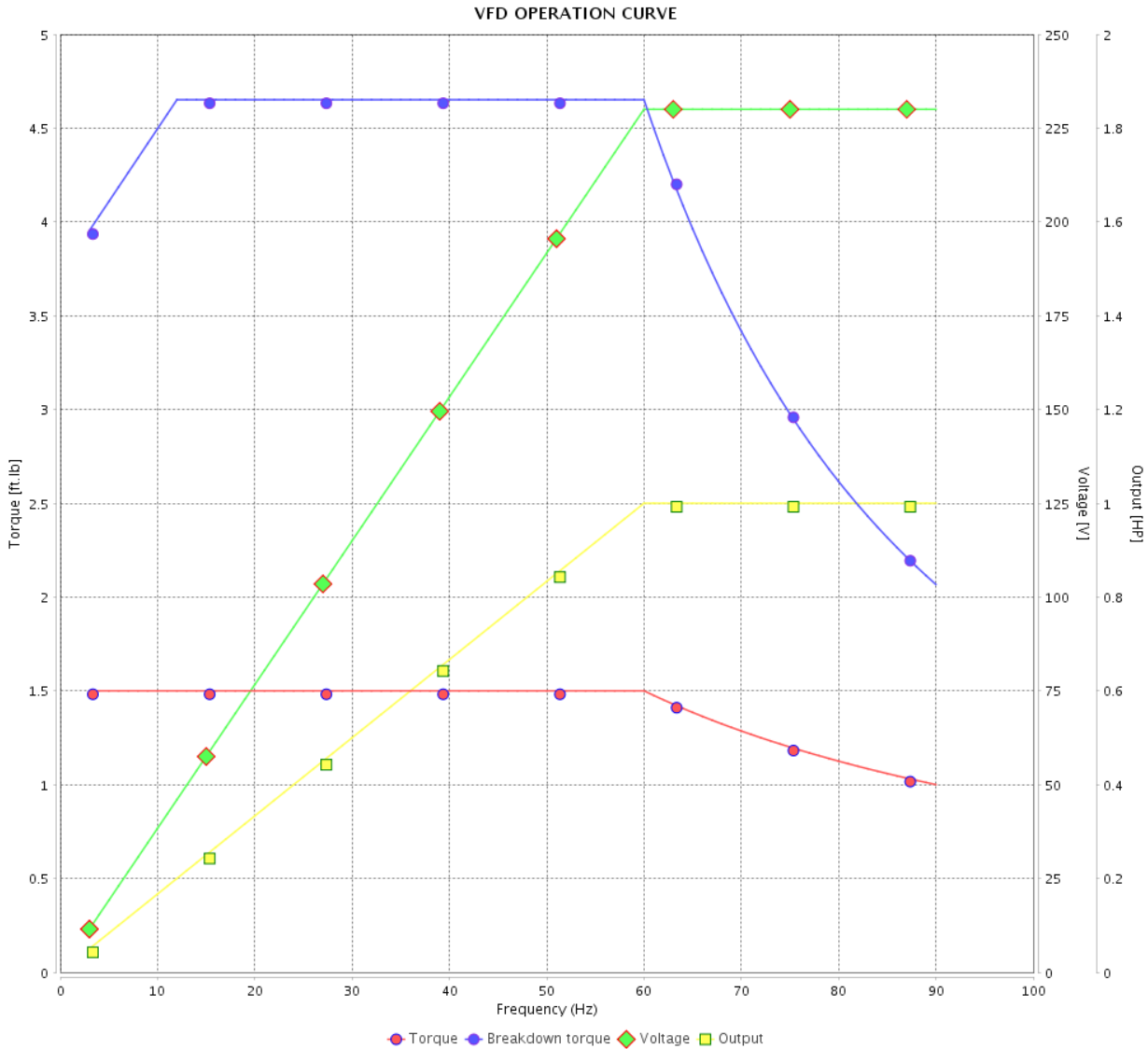

Performance : 230/460 V 60 Hz 2P

Rated current : 2.88/1.44 A  
 LRC : 8.2  
 Rated torque : 1.50 ft.lb  
 Locked rotor torque : 320 %  
 Breakdown torque : 400 %  
 Rated speed : 3500 rpm

Moment of inertia (J) : 0.0332 sq.ft.lb  
 Duty cycle : Cont.(S1)  
 Insulation class : F  
 Service factor : 1.25  
 Temperature rise : 80 K

Rev.	Changes Summary	Performed	Checked	Date
Performed by			Page	Revision
Checked by				
Date				
			30 / 36	

# VFD OPERATION CURVE

## Three Phase Induction Motor - Squirrel Cage



Customer : \_\_\_\_\_

Product line : NEMA Premium Efficiency Three-Phase      Product code : 12821880  
 Catalog # : 00136ET3ER143TC-W22

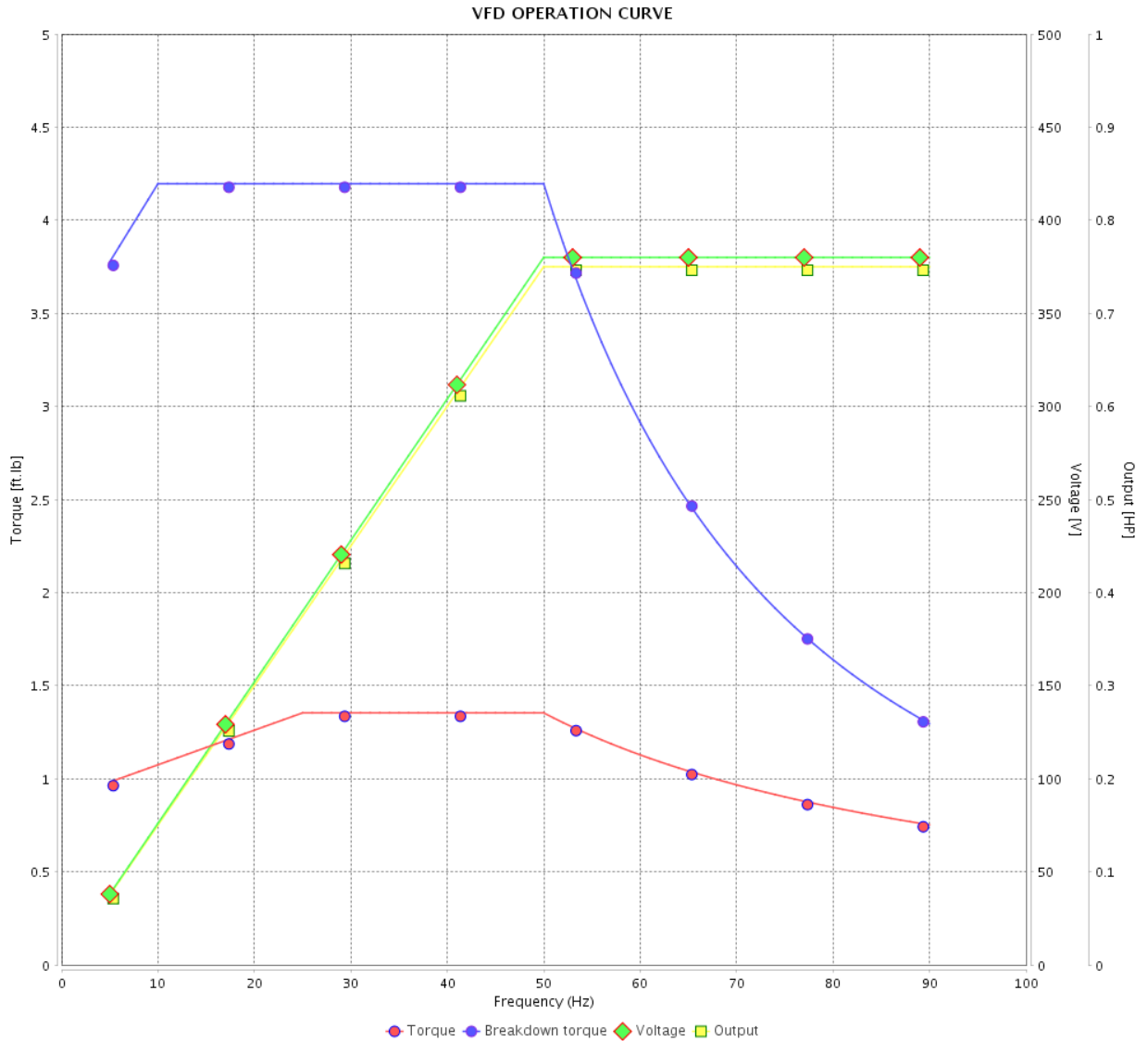

Performance : 380 V 50 Hz 2P IE4

Rated current : 1.31 A  
 LRC : 8.6  
 Rated torque : 1.35 ft.lb  
 Locked rotor torque : 330 %  
 Breakdown torque : 400 %  
 Rated speed : 2910 rpm

Moment of inertia (J) : 0.0332 sq.ft.lb  
 Duty cycle : Cont.(S1)  
 Insulation class : F  
 Service factor : 1.25  
 Temperature rise : 80 K

Rev.	Changes Summary	Performed	Checked	Date
Performed by			Page 31 / 36	Revision
Checked by				
Date	11/04/2022			

# VFD OPERATION CURVE

Three Phase Induction Motor - Squirrel Cage



Customer :

Product line : NEMA Premium Efficiency Three-Phase

Product code : 12821880

Catalog # : 00136ET3ER143TC-W22

VFD OPERATION CURVE

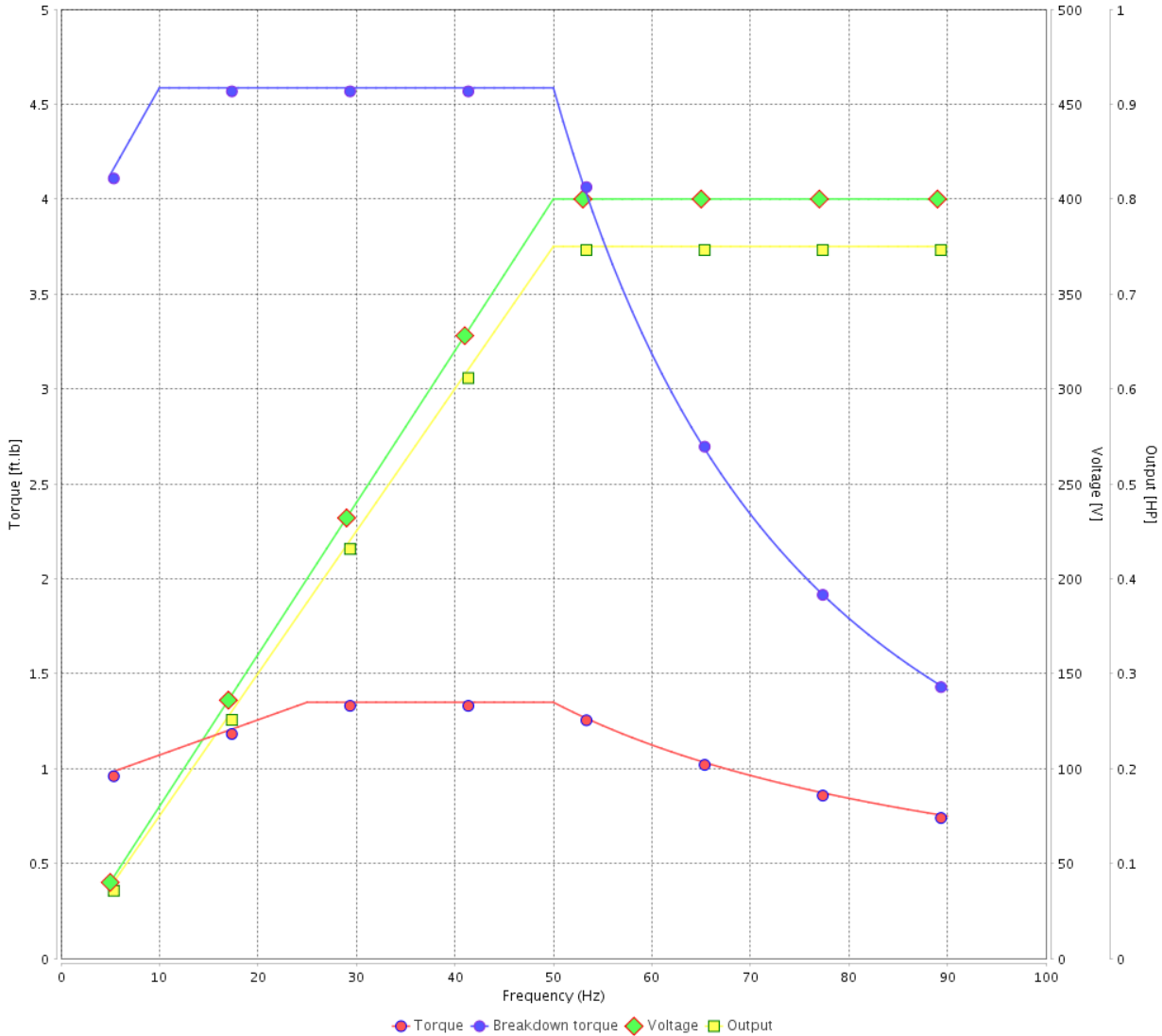

Performance : 400 V 50 Hz 2P IE4

Rated current : 1.30 A  
 LRC : 9.0  
 Rated torque : 1.35 ft.lb  
 Locked rotor torque : 370 %  
 Breakdown torque : 450 %  
 Rated speed : 2920 rpm

Moment of inertia (J) : 0.0332 sq.ft.lb  
 Duty cycle : Cont.(S1)  
 Insulation class : F  
 Service factor : 1.25  
 Temperature rise : 80 K

Rev.	Changes Summary	Performed	Checked	Date
Performed by			Page 32 / 36	Revision
Checked by				
Date	11/04/2022			



# VFD OPERATION CURVE

Three Phase Induction Motor - Squirrel Cage



Customer : \_\_\_\_\_

Product line : NEMA Premium Efficiency Three-Phase

Product code : 12821880

Catalog # : 00136ET3ER143TC-W22

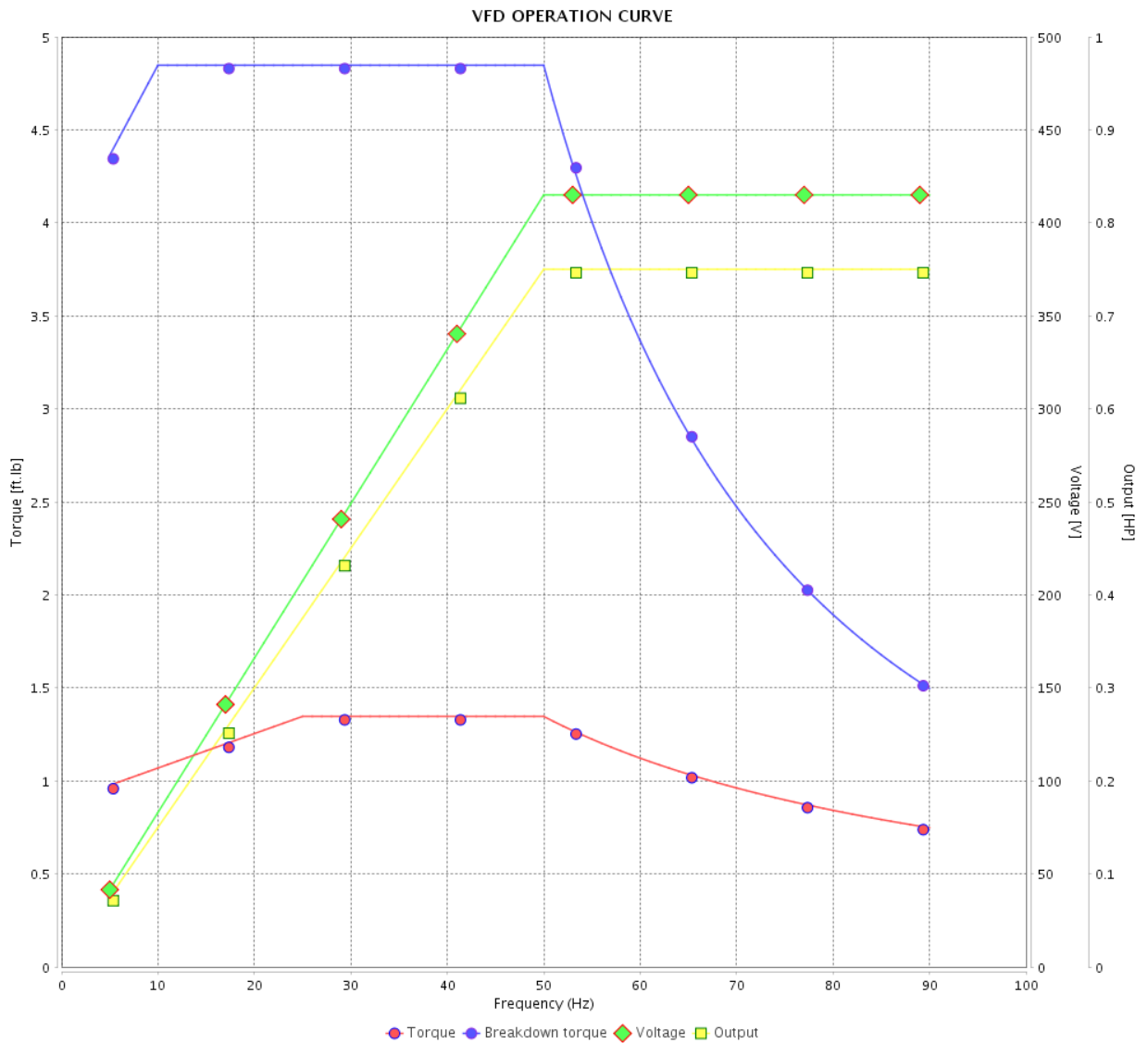

Performance : 415 V 50 Hz 2P IE4

Rated current : 1.30 A  
 LRC : 9.4  
 Rated torque : 1.35 ft.lb  
 Locked rotor torque : 409 %  
 Breakdown torque : 500 %  
 Rated speed : 2925 rpm

Moment of inertia (J) : 0.0332 sq.ft.lb  
 Duty cycle : Cont.(S1)  
 Insulation class : F  
 Service factor : 1.25  
 Temperature rise : 80 K

Rev.	Changes Summary	Performed	Checked	Date
Performed by			Page 33 / 36	Revision
Checked by				
Date	11/04/2022			

# VFD OPERATION CURVE

Three Phase Induction Motor - Squirrel Cage



Customer :

Product line : NEMA Premium Efficiency Three-Phase

Product code : 12821880

Catalog # : 00136ET3ER143TC-W22

VFD OPERATION CURVE

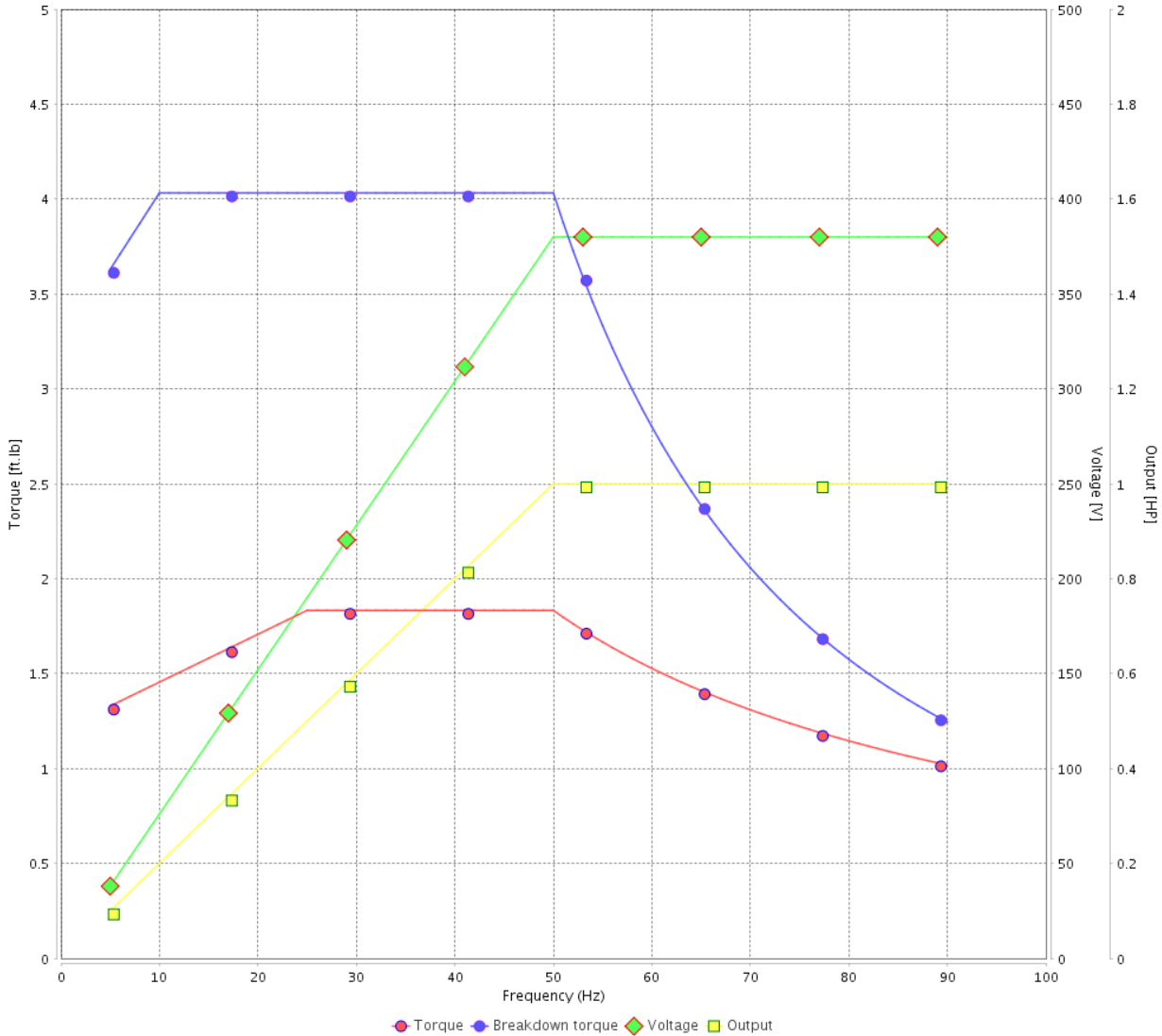

Performance : 380 V 50 Hz 2P IE2

Rated current : 1.68 A  
 LRC : 6.7  
 Rated torque : 1.83 ft.lb  
 Locked rotor torque : 240 %  
 Breakdown torque : 280 %  
 Rated speed : 2865 rpm

Moment of inertia (J) : 0.0332 sq.ft.lb  
 Duty cycle : Cont.(S1)  
 Insulation class : F  
 Service factor : 1.25  
 Temperature rise : 80 K

Rev.	Changes Summary	Performed	Checked	Date
Performed by			Page	Revision
Checked by				
Date				

# VFD OPERATION CURVE

## Three Phase Induction Motor - Squirrel Cage



Customer :

Product line : NEMA Premium Efficiency Three-Phase  
 Product code : 12821880  
 Catalog # : 00136ET3ER143TC-W22

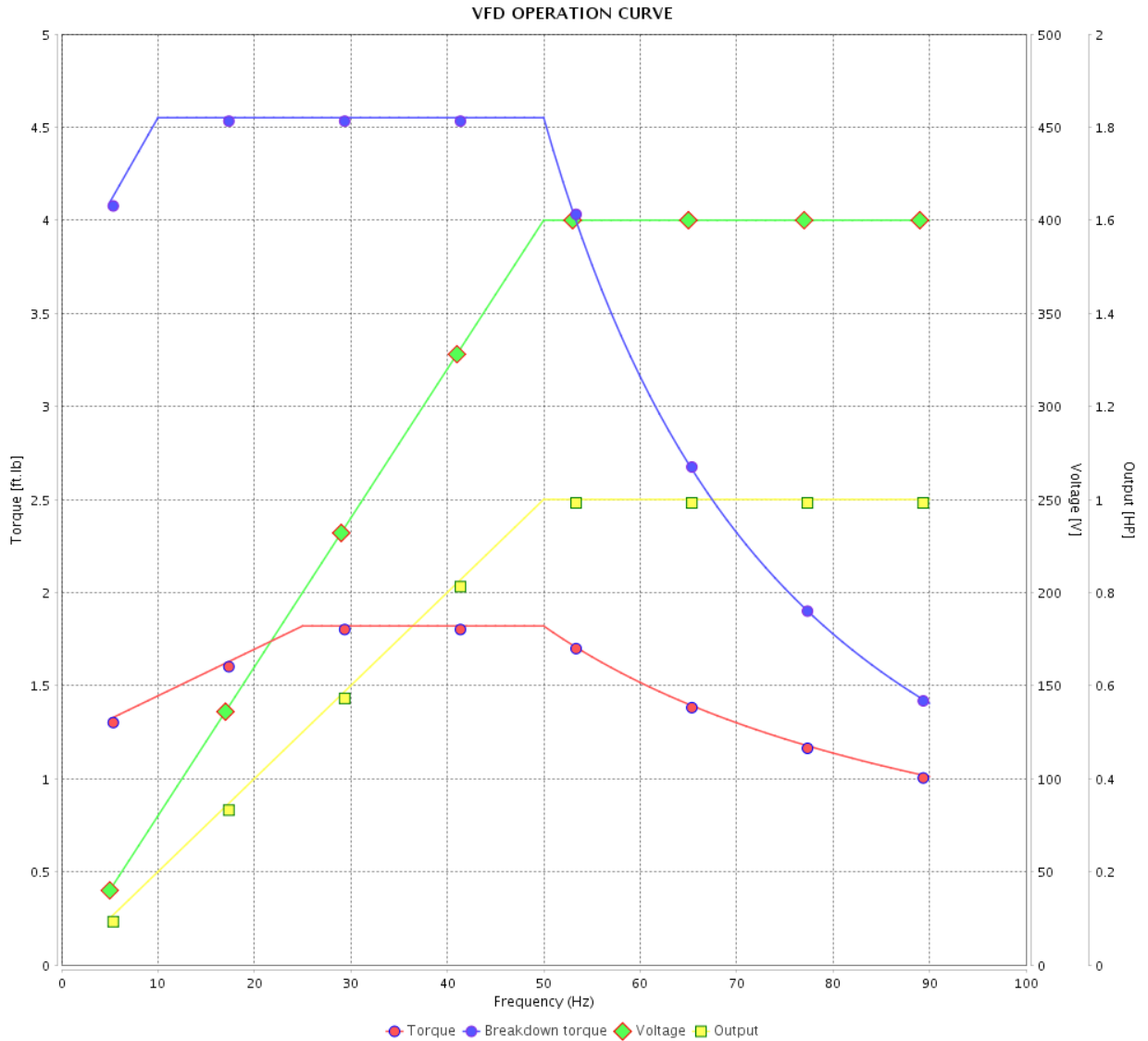

Performance : 400 V 50 Hz 2P IE2

Rated current : 1.65 A  
 LRC : 7.2  
 Rated torque : 1.82 ft.lb  
 Locked rotor torque : 270 %  
 Breakdown torque : 320 %  
 Rated speed : 2880 rpm

Moment of inertia (J) : 0.0332 sq.ft.lb  
 Duty cycle : Cont.(S1)  
 Insulation class : F  
 Service factor : 1.25  
 Temperature rise : 80 K

Rev.	Changes Summary	Performed	Checked	Date
Performed by		Page		Revision
Checked by		35 / 36		
Date		11/04/2022		

# VFD OPERATION CURVE

Three Phase Induction Motor - Squirrel Cage



Customer :

Product line : NEMA Premium Efficiency Three-Phase

Product code : 12821880

Catalog # : 00136ET3ER143TC-W22

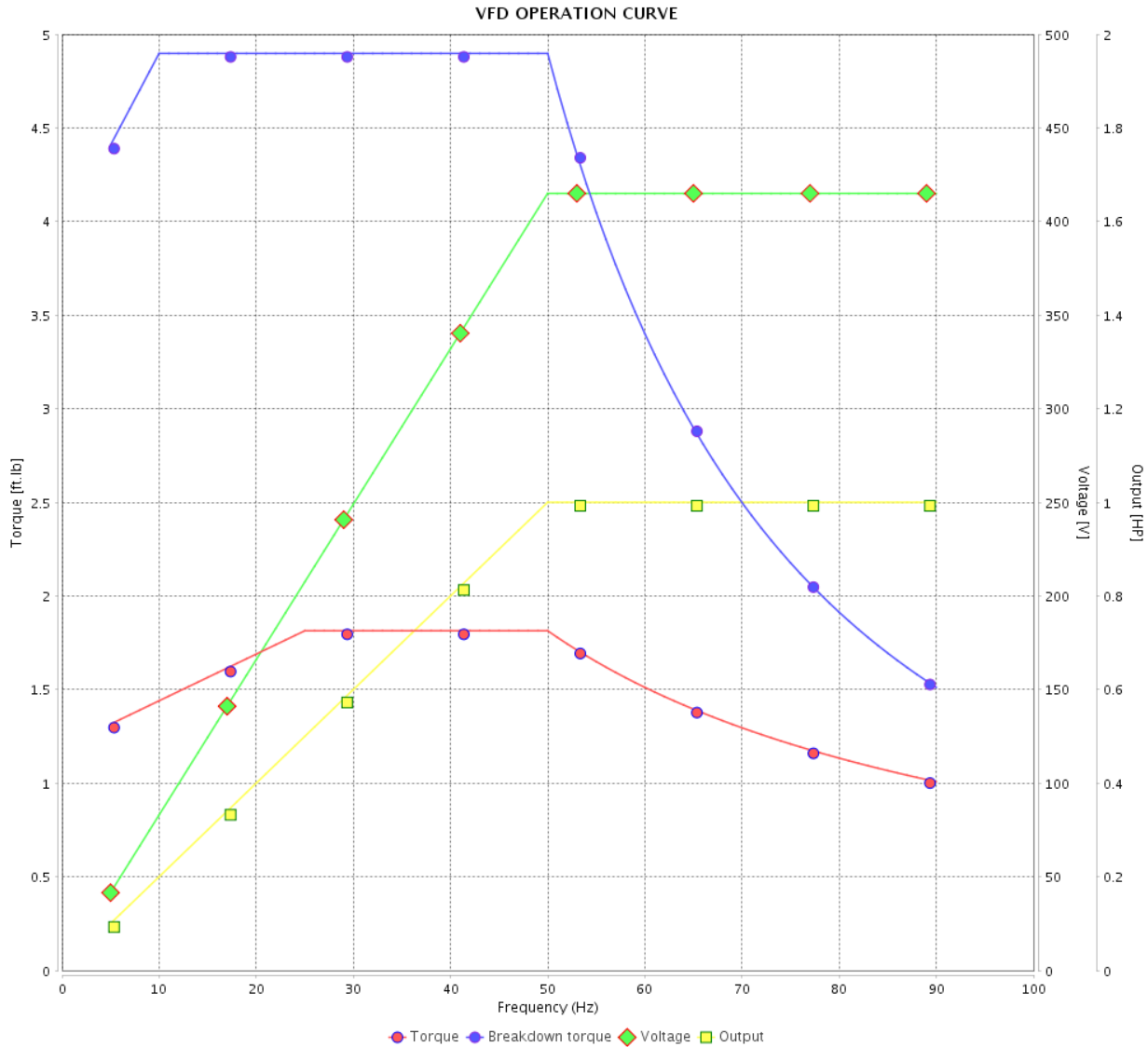

Performance : 415 V 50 Hz 2P IE2

Rated current : 1.63 A  
 LRC : 7.7  
 Rated torque : 1.81 ft.lb  
 Locked rotor torque : 300 %  
 Breakdown torque : 350 %  
 Rated speed : 2895 rpm

Moment of inertia (J) : 0.0332 sq.ft.lb  
 Duty cycle : Cont.(S1)  
 Insulation class : F  
 Service factor : 1.25  
 Temperature rise : 80 K

Rev.	Changes Summary	Performed	Checked	Date
Performed by			Page 36 / 36	Revision
Checked by				
Date	11/04/2022			

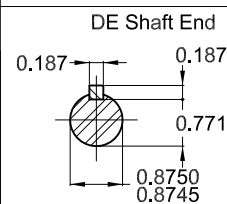
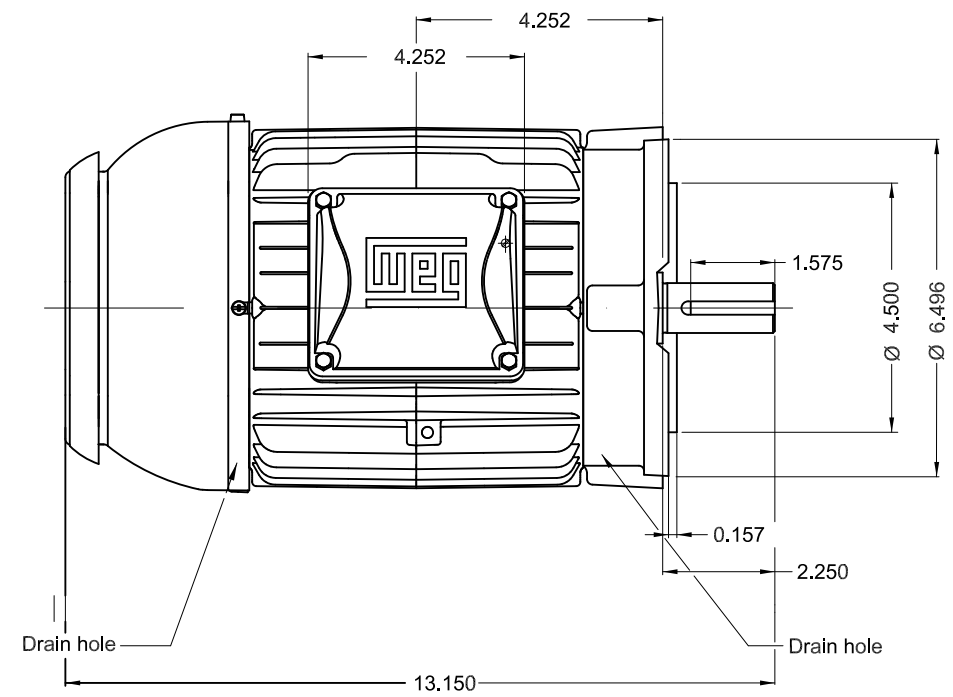
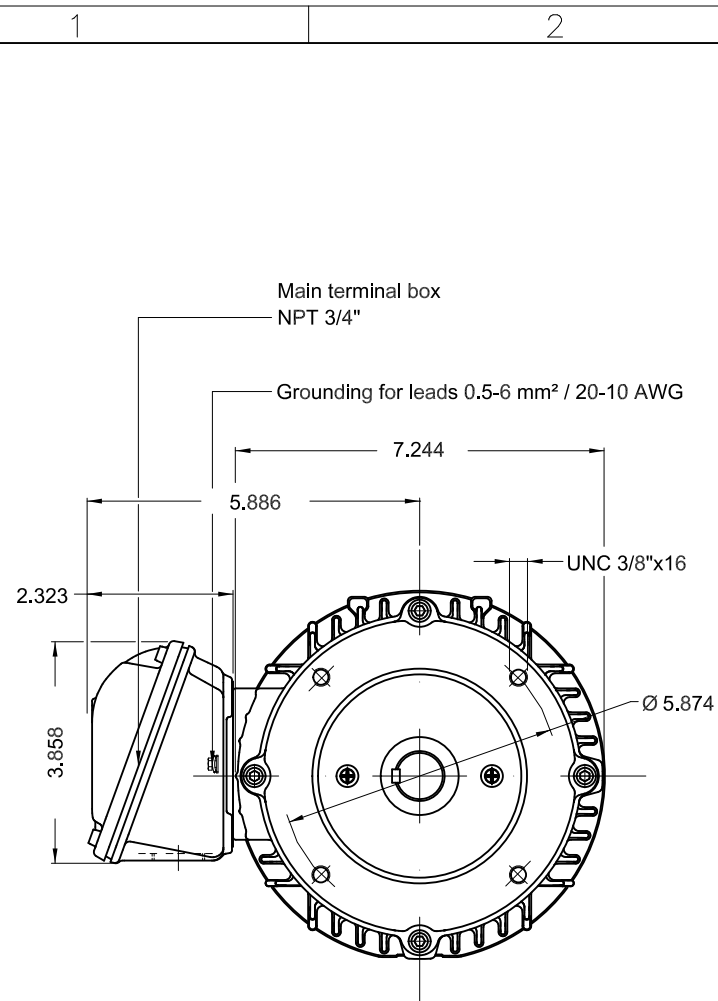

Bearing cap
Color RAL 5009
Painting plan 207A
Mounting NEMA W-6
Mounting V18

1 HP 02 Poles 60 Hz A

ECM	LOC	SUMMARY OF MODIFICATIONS	EXECUTED	CHECKED	RELEASED	DATE	VER
EXECUTED	PIRWUSER	THREE PH. MOTOR W22 PREM. EFF.					
CHECKED		FRAME 143TC IP55 TEFC					
RELEASED							
REL DT.	WMO	Jaragua do Sul	Product Engineering	SHEET	1 / 1		

**PREVIEW**  
WDD

