

DATA SHEET

Three Phase Induction Motor - Squirrel Cage



Customer :					
Product line	: NEMA Premium Efficiency Three-Phase	Product code :	11523675		
		Catalog # :	00158ET3E145JM-W22		
Frame	: 143/5JM	Cooling method	: IC411 - TEFC		
Insulation class	: F	Mounting	: F-1		
Duty cycle	: Cont.(S1)	Rotation ¹	: Both (CW and CCW)		
Ambient temperature	: -20°C to +40°C	Starting method	: Direct On Line		
Altitude	: 1000 m.a.s.l.	Approx. weight ²	: 53.9 lb		
Protection degree	: IP55	Moment of inertia (J)	: 0.1431 sq.ft.lb		
Design	: B				
Output [HP]	1.5	1.5	1.5	1.5	
Poles	4	4	4	4	
Frequency [Hz]	60	50	50	50	
Rated voltage [V]	230/460	380	400	415	
Rated current [A]	4.04/2.02	2.42	2.33	2.30	
L. R. Amperes [A]	33.9/17.0	15.5	16.3	17.0	
LRC [A]	8.4x(Code L)	6.4x(Code H)	7.0x(Code J)	7.4x(Code K)	
No load current [A]	2.20/1.10	1.10	1.20	1.30	
Rated speed [RPM]	1755	1440	1445	1450	
Slip [%]	2.50	4.00	3.67	3.33	
Rated torque [ft.lb]	4.49	5.47	5.45	5.43	
Locked rotor torque [%]	290	220	250	280	
Breakdown torque [%]	350	250	290	320	
Service factor	1.25	1.25	1.25	1.25	
Temperature rise	80 K	80 K	80 K	80 K	
Locked rotor time	25s (cold) 14s (hot)	25s (cold) 14s (hot)	25s (cold) 14s (hot)	25s (cold) 14s (hot)	
Noise level ²	51.0 dB(A)	49.0 dB(A)	49.0 dB(A)	49.0 dB(A)	
Efficiency (%)	25%	81.3	82.0	82.1	80.5
	50%	82.5	82.5	82.5	81.0
	75%	85.5	84.0	84.0	84.0
	100%	86.5	84.1	84.1	84.1
Power Factor	25%	0.35	0.41	0.37	0.34
	50%	0.60	0.67	0.63	0.60
	75%	0.70	0.76	0.74	0.70
	100%	0.79	0.82	0.81	0.79
Bearing type	: Drive end : 6206 ZZ Non drive end : 6204 ZZ	Foundation loads			
Sealing	: V'Ring V'Ring	Max. traction	: 124 lb		
Lubrication interval	: - -	Max. compression	: 178 lb		
Lubricant amount	: - -				
Lubricant type	: Mobil Polyrex EM				
Notes					
USABLE @208V 4.36A SF 1.15 SFA 5.01A					
This revision replaces and cancel the previous one, which must be eliminated. (1) Looking the motor from the shaft end. (2) Measured at 1m and with tolerance of +3dB(A). (3) Approximate weight subject to changes after manufacturing process. (4) At 100% of full load.			These are average values based on tests with sinusoidal power supply, subject to the tolerances stipulated in NEMA MG-1.		
Rev.	Changes Summary		Performed	Checked	Date
Performed by					
Checked by				Page	Revision
Date	12/04/2022			1 / 21	

TORQUE AND CURRENT VS SPEED CURVE

Three Phase Induction Motor - Squirrel Cage



Customer :

Product line : NEMA Premium Efficiency Three-Phase

Product code : 11523675

Catalog # : 00158ET3E145JM-W22

TORQUE AND CURRENT VS SPEED CURVE

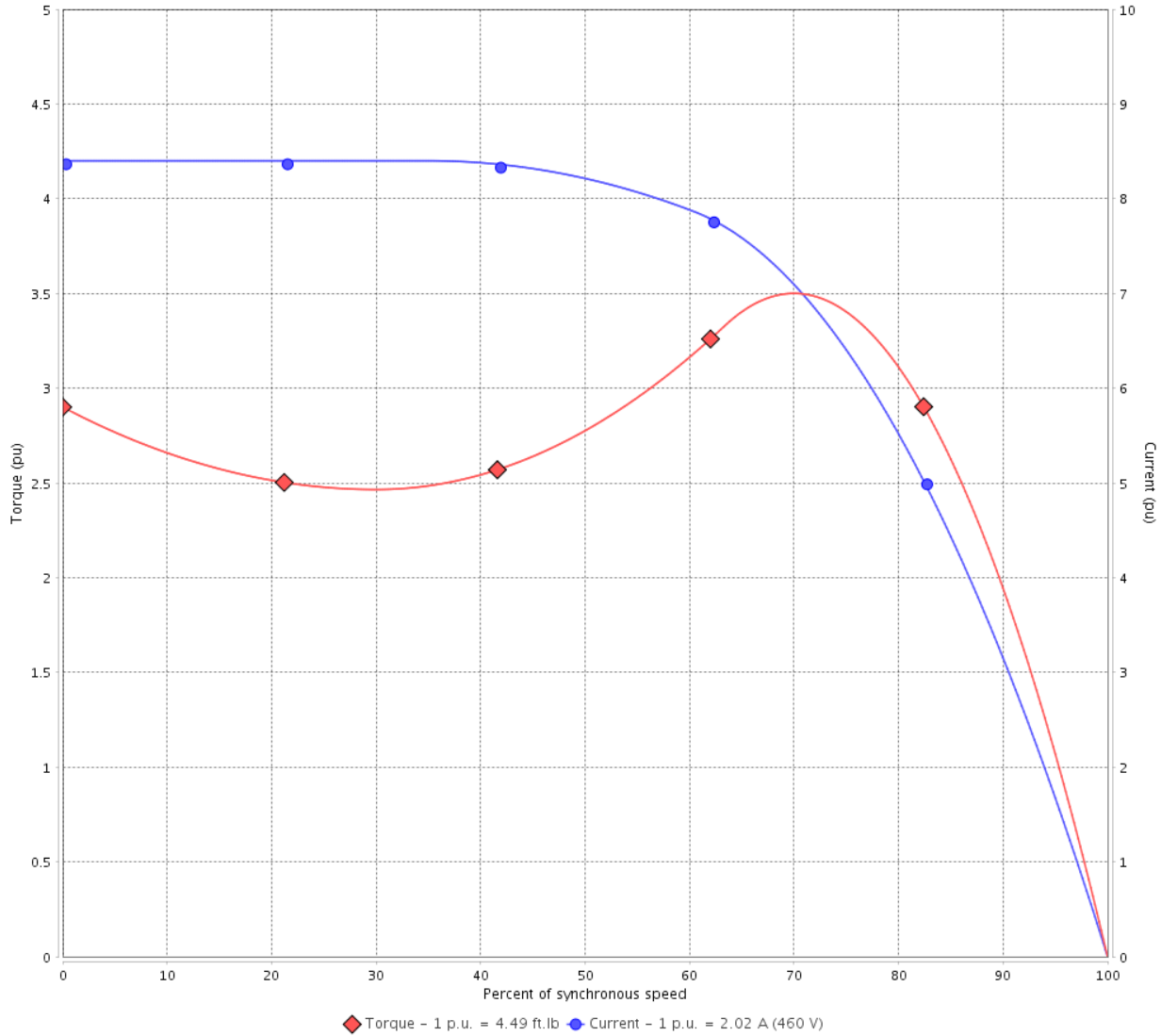

Performance : 230/460 V 60 Hz 4P

Rated current : 4.04/2.02 A
 LRC : 8.4
 Rated torque : 4.49 ft.lb
 Locked rotor torque : 290 %
 Breakdown torque : 350 %
 Rated speed : 1755 rpm

Moment of inertia (J) : 0.1431 sq.ft.lb
 Duty cycle : Cont.(S1)
 Insulation class : F
 Service factor : 1.25
 Temperature rise : 80 K
 Design : B

Locked rotor time : 25s (cold) 14s (hot)

Rev.	Changes Summary	Performed	Checked	Date
Performed by			Page 2 / 21	Revision
Checked by				
Date	12/04/2022			

TORQUE AND CURRENT VS SPEED CURVE



Three Phase Induction Motor - Squirrel Cage

Customer :

Product line : NEMA Premium Efficiency Three-Phase

Product code : 11523675

Catalog # : 00158ET3E145JM-W22

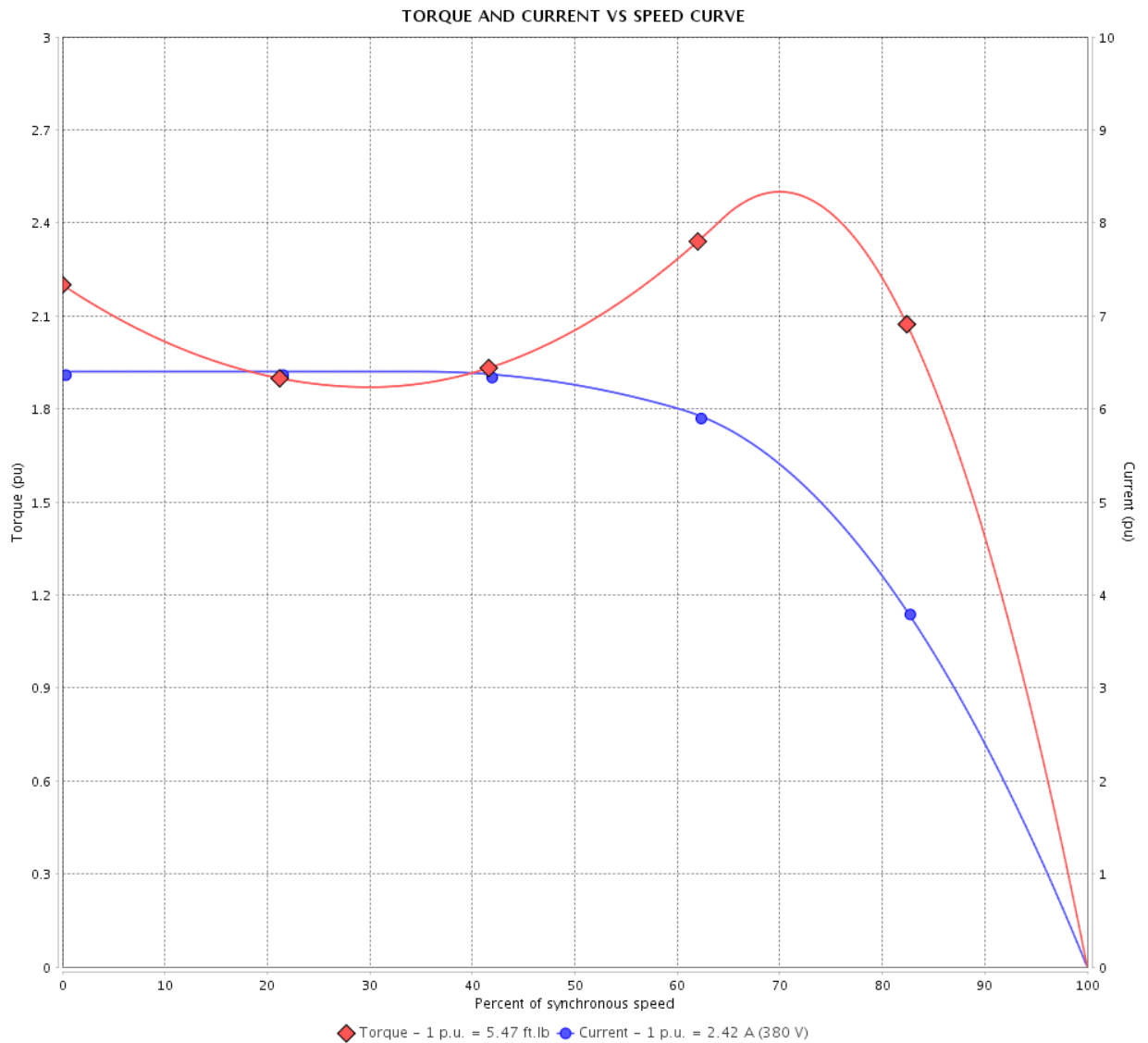

Performance : 380 V 50 Hz 4P IE3

Rated current	: 2.42 A	Moment of inertia (J)	: 0.1431 sq.ft.lb
LRC	: 6.4	Duty cycle	: Cont.(S1)
Rated torque	: 5.47 ft.lb	Insulation class	: F
Locked rotor torque	: 220 %	Service factor	: 1.25
Breakdown torque	: 250 %	Temperature rise	: 80 K
Rated speed	: 1440 rpm	Design	: B

Locked rotor time : 25s (cold) 14s (hot)

Rev.	Changes Summary	Performed	Checked	Date
Performed by			Page 3 / 21	Revision
Checked by				
Date	12/04/2022			

TORQUE AND CURRENT VS SPEED CURVE

Three Phase Induction Motor - Squirrel Cage



Customer :

Product line : NEMA Premium Efficiency Three-Phase

Product code : 11523675

Catalog # : 00158ET3E145JM-W22

TORQUE AND CURRENT VS SPEED CURVE

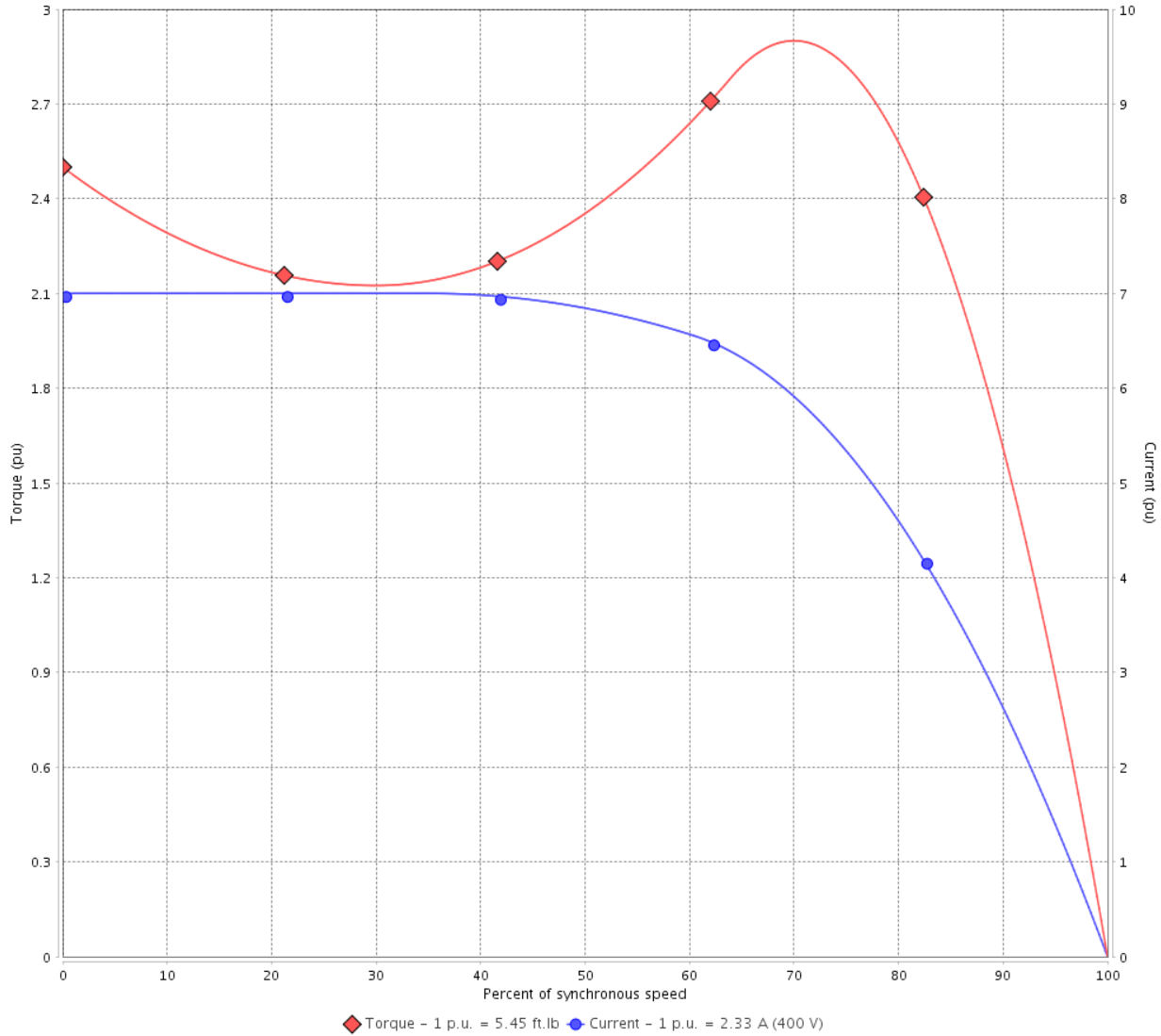

Performance : 400 V 50 Hz 4P IE3

Rated current	: 2.33 A	Moment of inertia (J)	: 0.1431 sq.ft.lb
LRC	: 7.0	Duty cycle	: Cont.(S1)
Rated torque	: 5.45 ft.lb	Insulation class	: F
Locked rotor torque	: 250 %	Service factor	: 1.25
Breakdown torque	: 290 %	Temperature rise	: 80 K
Rated speed	: 1445 rpm	Design	: B

Locked rotor time : 25s (cold) 14s (hot)

Rev.	Changes Summary	Performed	Checked	Date
Performed by			Page 4 / 21	Revision
Checked by				
Date	12/04/2022			

TORQUE AND CURRENT VS SPEED CURVE



Three Phase Induction Motor - Squirrel Cage

Customer :

Product line : NEMA Premium Efficiency Three-Phase

Product code : 11523675

Catalog # : 00158ET3E145JM-W22

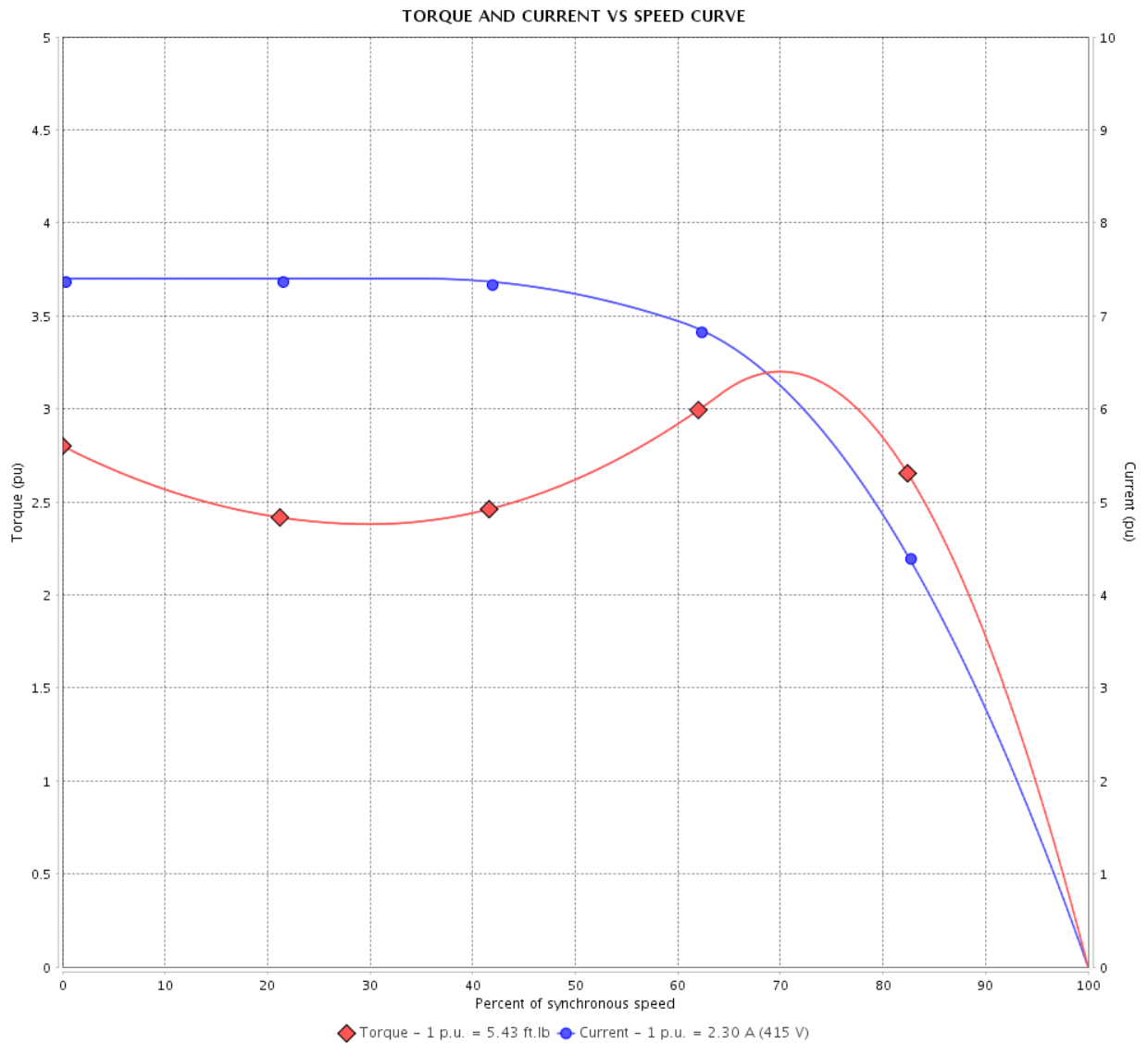

Performance : 415 V 50 Hz 4P IE3

Rated current : 2.30 A
 LRC : 7.4
 Rated torque : 5.43 ft.lb
 Locked rotor torque : 280 %
 Breakdown torque : 320 %
 Rated speed : 1450 rpm

Moment of inertia (J) : 0.1431 sq.ft.lb
 Duty cycle : Cont.(S1)
 Insulation class : F
 Service factor : 1.25
 Temperature rise : 80 K
 Design : B

Locked rotor time : 25s (cold) 14s (hot)

Rev.	Changes Summary	Performed	Checked	Date
Performed by			Page 5 / 21	Revision
Checked by				
Date	12/04/2022			

LOAD PERFORMANCE CURVE

Three Phase Induction Motor - Squirrel Cage



Customer :

Product line : NEMA Premium Efficiency Three-Phase

Product code : 11523675

Catalog # : 00158ET3E145JM-W22

LOAD PERFORMANCE CURVE

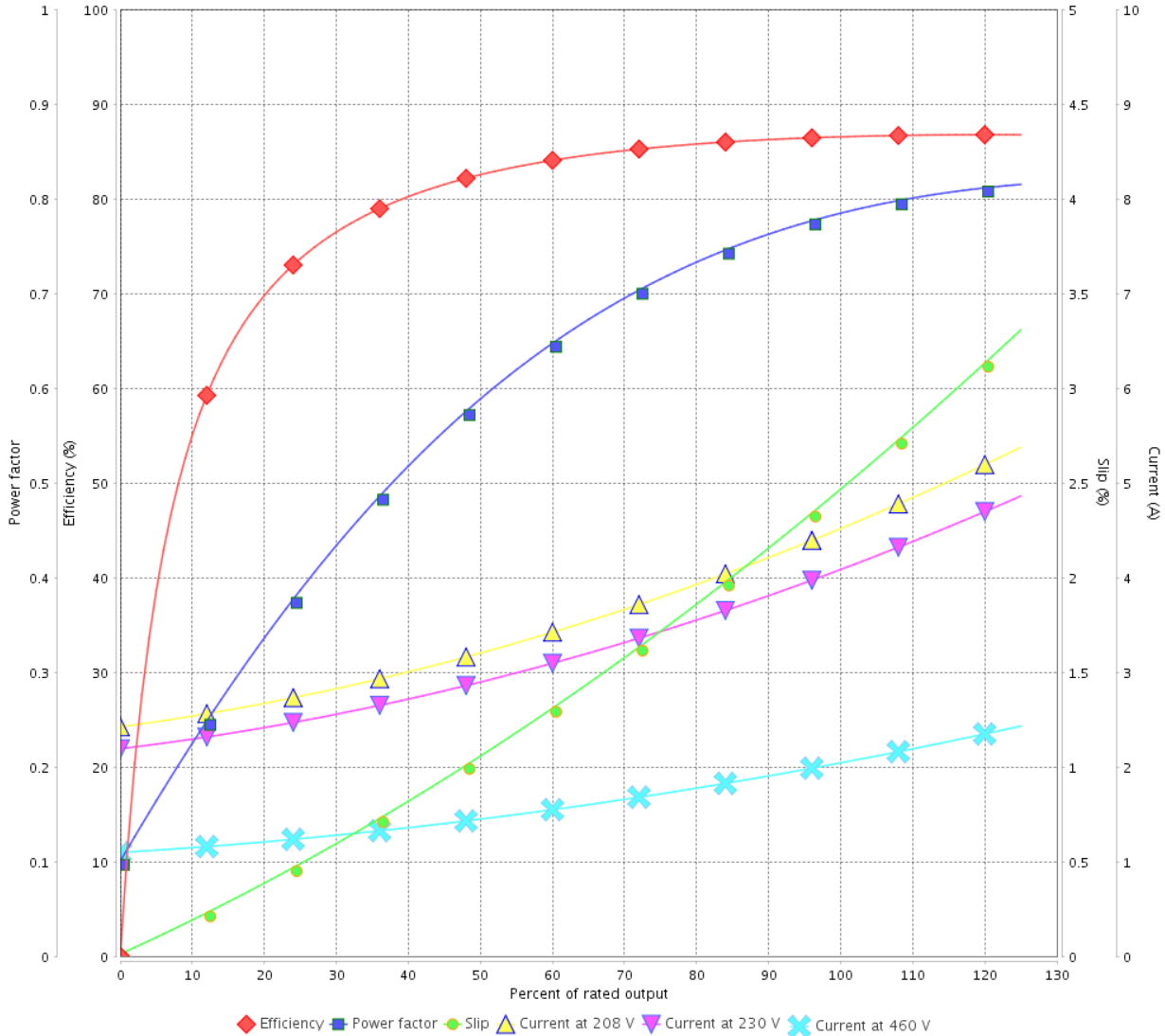

Performance : 230/460 V 60 Hz 4P

Rated current : 4.04/2.02 A
 LRC : 8.4
 Rated torque : 4.49 ft.lb
 Locked rotor torque : 290 %
 Breakdown torque : 350 %
 Rated speed : 1755 rpm

Moment of inertia (J) : 0.1431 sq.ft.lb
 Duty cycle : Cont.(S1)
 Insulation class : F
 Service factor : 1.25
 Temperature rise : 80 K
 Design : B

Rev.	Changes Summary	Performed	Checked	Date
Performed by			Page 6 / 21	Revision
Checked by				
Date	12/04/2022			

LOAD PERFORMANCE CURVE

Three Phase Induction Motor - Squirrel Cage



Customer :

Product line : NEMA Premium Efficiency Three-Phase

Product code : 11523675

Catalog # : 00158ET3E145JM-W22

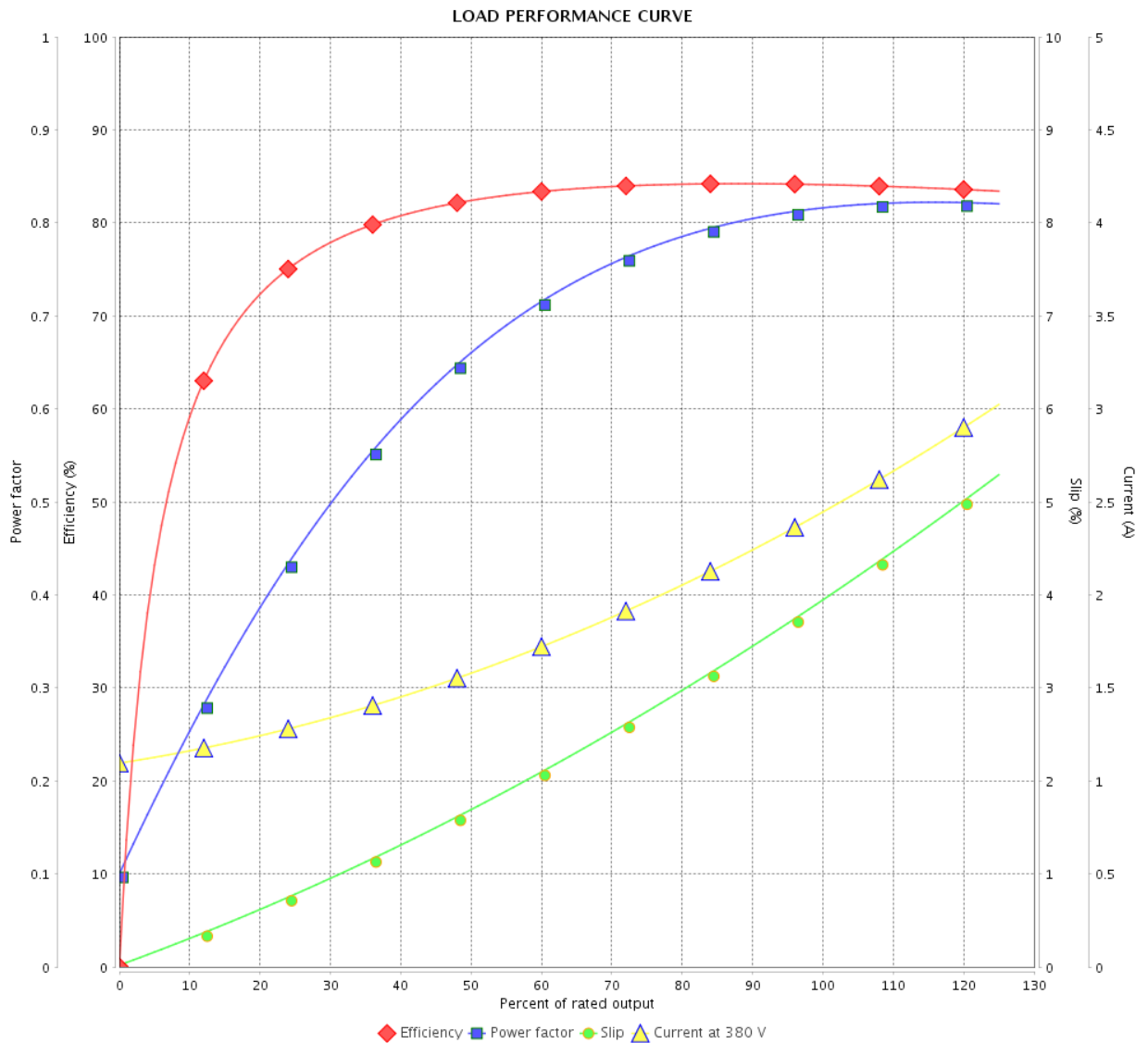

Performance : 380 V 50 Hz 4P IE3

Rated current : 2.42 A
 LRC : 6.4
 Rated torque : 5.47 ft.lb
 Locked rotor torque : 220 %
 Breakdown torque : 250 %
 Rated speed : 1440 rpm

Moment of inertia (J) : 0.1431 sq.ft.lb
 Duty cycle : Cont.(S1)
 Insulation class : F
 Service factor : 1.25
 Temperature rise : 80 K
 Design : B

Rev.	Changes Summary	Performed	Checked	Date
Performed by			Page	Revision
Checked by			7 / 21	
Date	12/04/2022			

LOAD PERFORMANCE CURVE

Three Phase Induction Motor - Squirrel Cage



Customer :

Product line : NEMA Premium Efficiency Three-Phase

Product code : 11523675

Catalog # : 00158ET3E145JM-W22

LOAD PERFORMANCE CURVE

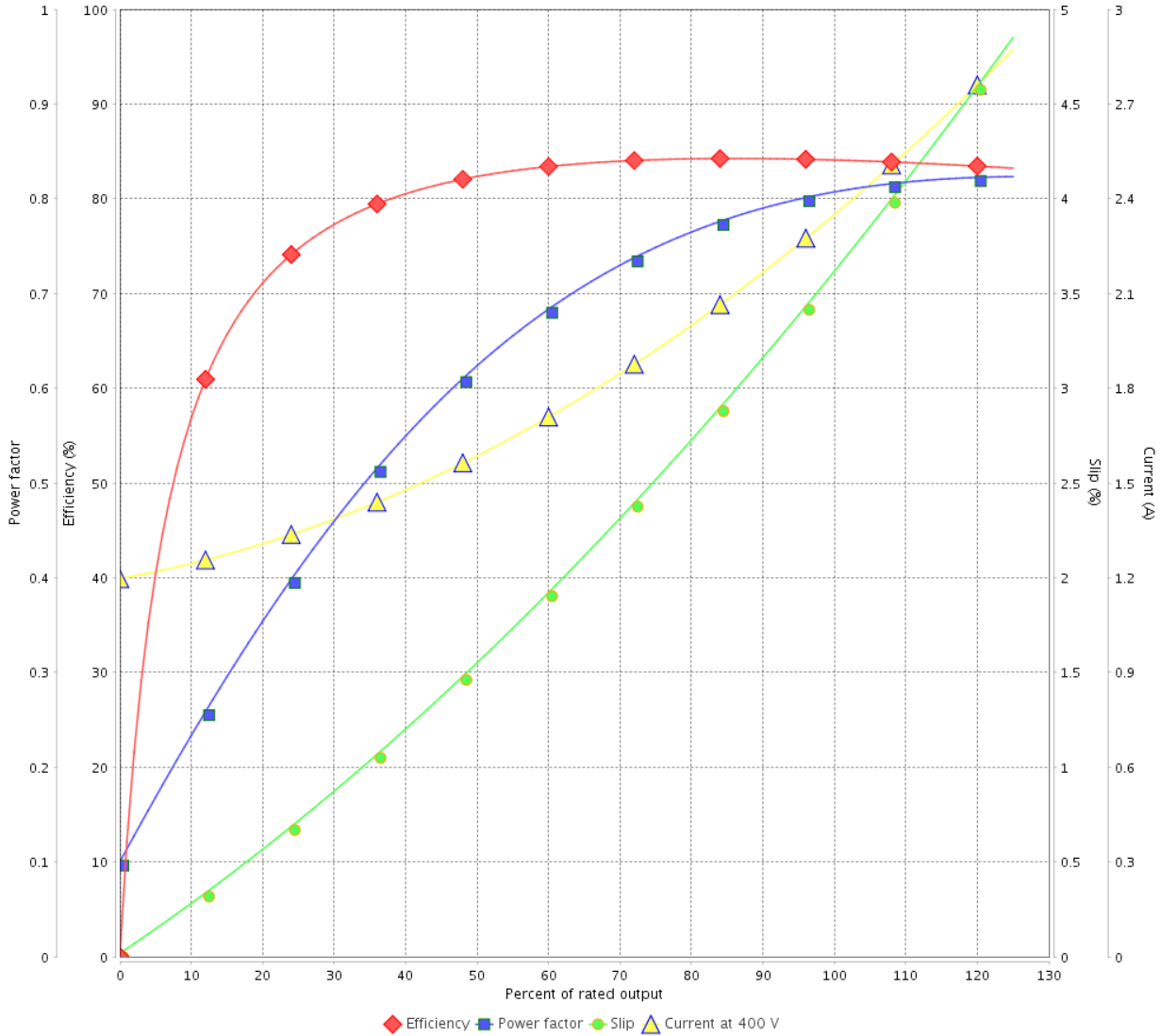

Performance : 400 V 50 Hz 4P IE3

Rated current : 2.33 A
 LRC : 7.0
 Rated torque : 5.45 ft.lb
 Locked rotor torque : 250 %
 Breakdown torque : 290 %
 Rated speed : 1445 rpm

Moment of inertia (J) : 0.1431 sq.ft.lb
 Duty cycle : Cont.(S1)
 Insulation class : F
 Service factor : 1.25
 Temperature rise : 80 K
 Design : B

Rev.	Changes Summary	Performed	Checked	Date
Performed by			Page 8 / 21	Revision
Checked by				
Date	12/04/2022			

LOAD PERFORMANCE CURVE

Three Phase Induction Motor - Squirrel Cage



Customer :

Product line : NEMA Premium Efficiency Three-Phase

Product code : 11523675

Catalog # : 00158ET3E145JM-W22

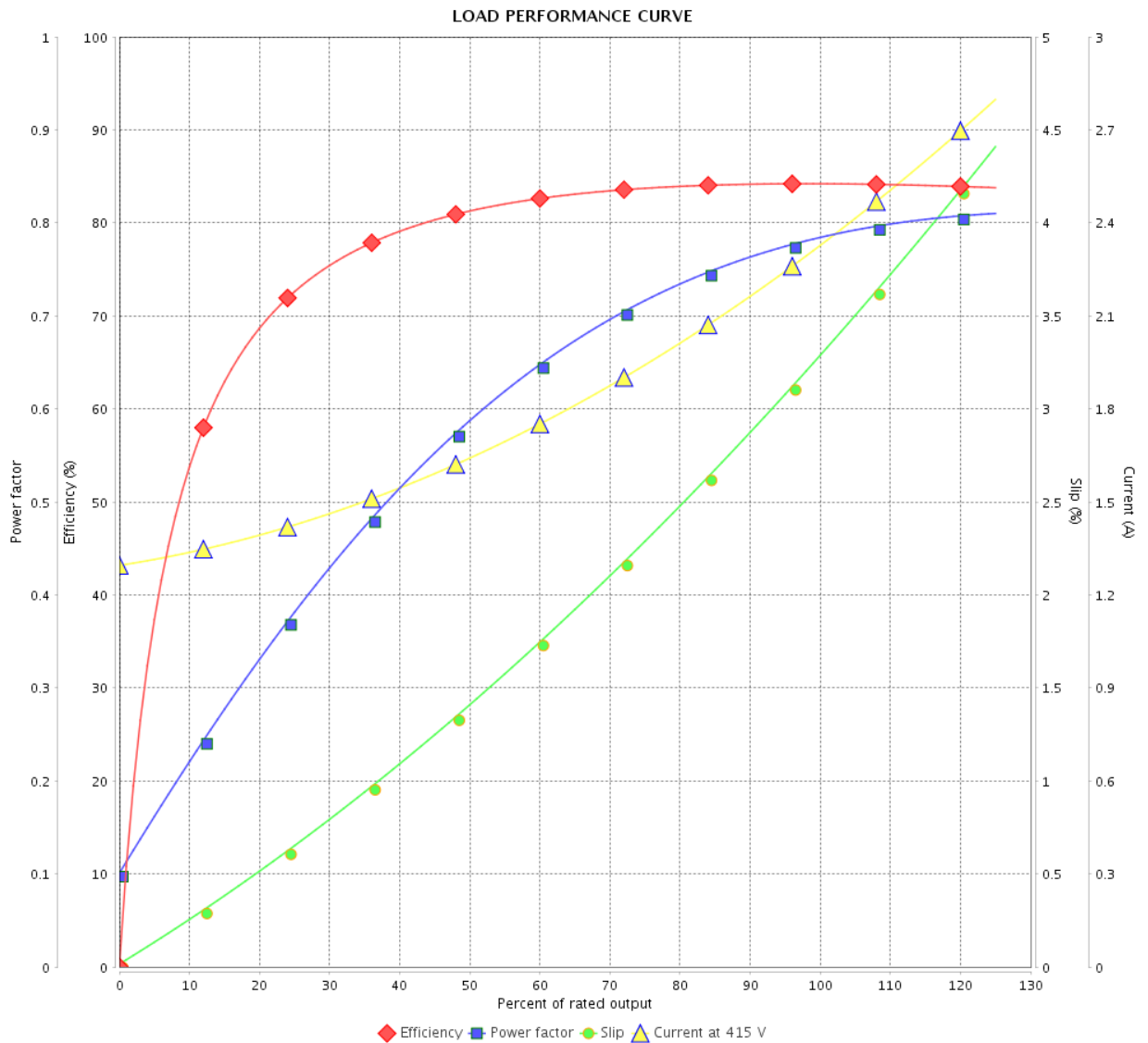

Performance : 415 V 50 Hz 4P IE3

Rated current : 2.30 A
 LRC : 7.4
 Rated torque : 5.43 ft.lb
 Locked rotor torque : 280 %
 Breakdown torque : 320 %
 Rated speed : 1450 rpm

Moment of inertia (J) : 0.1431 sq.ft.lb
 Duty cycle : Cont.(S1)
 Insulation class : F
 Service factor : 1.25
 Temperature rise : 80 K
 Design : B

Rev.	Changes Summary	Performed	Checked	Date
Performed by		Page		Revision
Checked by		9 / 21		
Date		12/04/2022		

THERMAL LIMIT CURVE



Three Phase Induction Motor - Squirrel Cage

Customer :

Product line : NEMA Premium Efficiency Three-Phase
 Product code : 11523675
 Catalog # : 00158ET3E145JM-W22

Performance : 230/460 V 60 Hz 4P

Rated current : 4.04/2.02 A	Moment of inertia (J) : 0.1431 sq.ft.lb
LRC : 8.4	Duty cycle : Cont.(S1)
Rated torque : 4.49 ft.lb	Insulation class : F
Locked rotor torque : 290 %	Service factor : 1.25
Breakdown torque : 350 %	Temperature rise : 80 K
Rated speed : 1755 rpm	Design : B

Heating constant

Cooling constant

Rev.	Changes Summary	Performed	Checked	Date
Performed by			Page 10 / 21	Revision
Checked by				
Date	12/04/2022			

THERMAL LIMIT CURVE

Three Phase Induction Motor - Squirrel Cage



Customer : _____

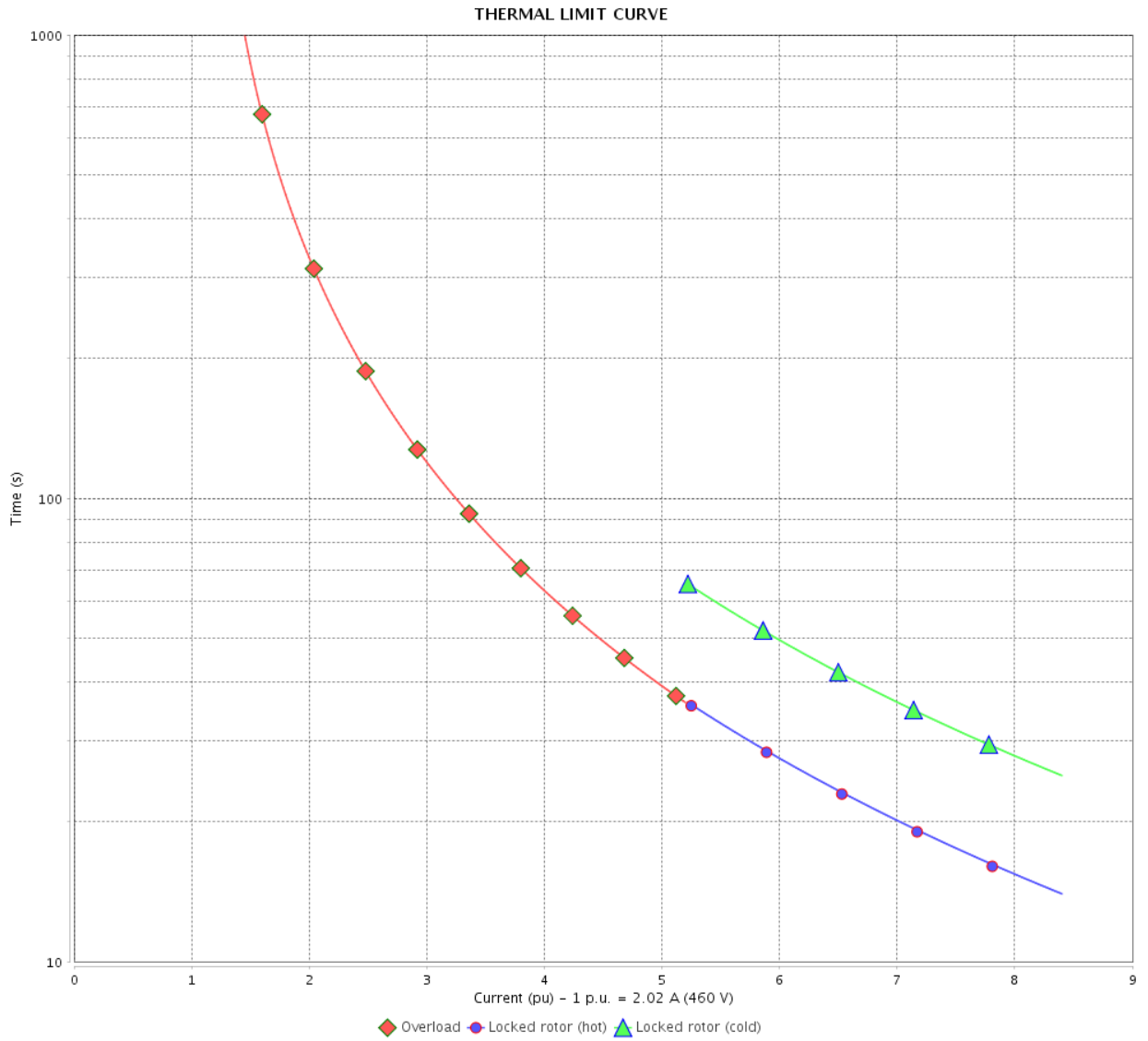

Rev.	Changes Summary	Performed	Checked	Date
Performed by		Page		Revision
Checked by		11 / 21		
Date		12/04/2022		

THERMAL LIMIT CURVE



Three Phase Induction Motor - Squirrel Cage

Customer :

Product line : NEMA Premium Efficiency Three-Phase
Product code : 11523675
Catalog # : 00158ET3E145JM-W22

Performance : 380 V 50 Hz 4P IE3

Rated current	: 2.42 A	Moment of inertia (J)	: 0.1431 sq.ft.lb
LRC	: 6.4	Duty cycle	: Cont.(S1)
Rated torque	: 5.47 ft.lb	Insulation class	: F
Locked rotor torque	: 220 %	Service factor	: 1.25
Breakdown torque	: 250 %	Temperature rise	: 80 K
Rated speed	: 1440 rpm	Design	: B

Heating constant

Cooling constant

Rev.	Changes Summary	Performed	Checked	Date
Performed by				
Checked by			Page	Revision
Date	12/04/2022		12 / 21	

THERMAL LIMIT CURVE

Three Phase Induction Motor - Squirrel Cage



Customer : _____

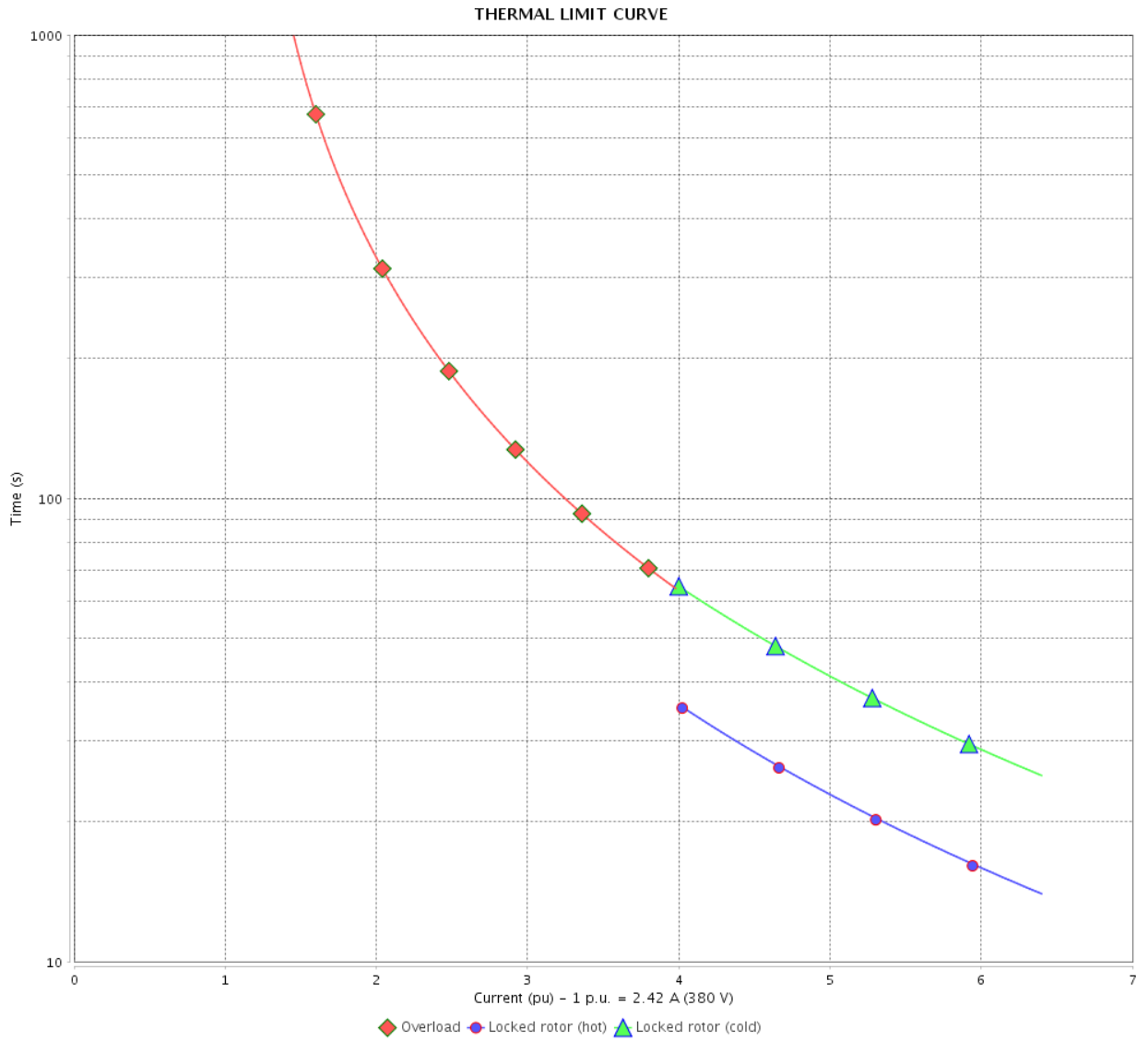

Rev.	Changes Summary	Performed	Checked	Date
Performed by		Page		Revision
Checked by		13 / 21		
Date		12/04/2022		

THERMAL LIMIT CURVE



Three Phase Induction Motor - Squirrel Cage

Customer :

Product line : NEMA Premium Efficiency Three-Phase
 Product code : 11523675
 Catalog # : 00158ET3E145JM-W22

Performance : 400 V 50 Hz 4P IE3

Rated current : 2.33 A	Moment of inertia (J) : 0.1431 sq.ft.lb
LRC : 7.0	Duty cycle : Cont.(S1)
Rated torque : 5.45 ft.lb	Insulation class : F
Locked rotor torque : 250 %	Service factor : 1.25
Breakdown torque : 290 %	Temperature rise : 80 K
Rated speed : 1445 rpm	Design : B

Heating constant

Cooling constant

Rev.	Changes Summary	Performed	Checked	Date
Performed by			Page 14 / 21	Revision
Checked by				
Date	12/04/2022			

THERMAL LIMIT CURVE

Three Phase Induction Motor - Squirrel Cage



Customer : _____

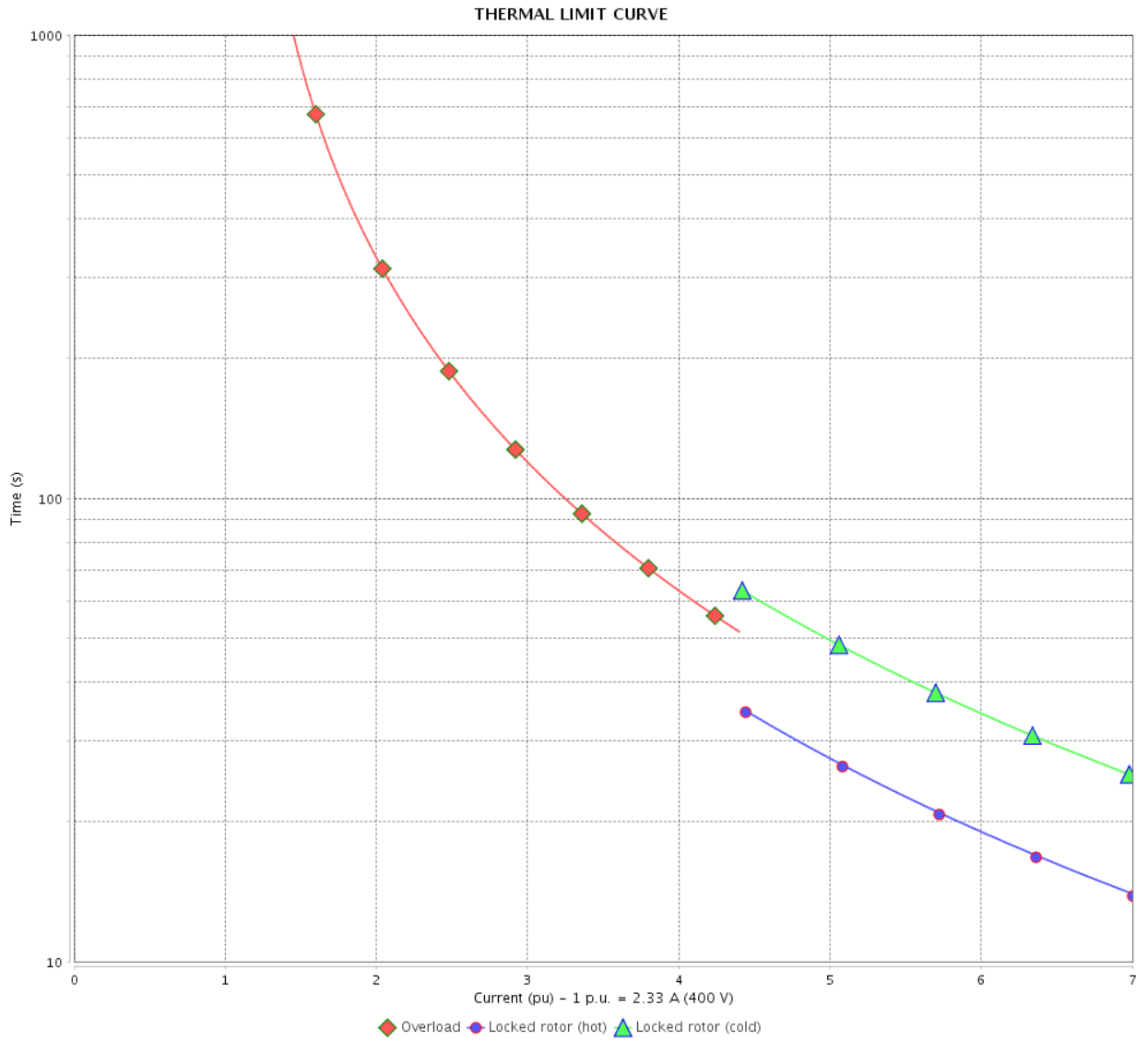

Rev.	Changes Summary	Performed	Checked	Date
Performed by		Page 15 / 21		Revision
Checked by				
Date				

THERMAL LIMIT CURVE

Three Phase Induction Motor - Squirrel Cage



Customer :

Product line : NEMA Premium Efficiency Three-Phase
Product code : 11523675
Catalog # : 00158ET3E145JM-W22

Performance : 415 V 50 Hz 4P IE3

Rated current	: 2.30 A	Moment of inertia (J)	: 0.1431 sq.ft.lb
LRC	: 7.4	Duty cycle	: Cont.(S1)
Rated torque	: 5.43 ft.lb	Insulation class	: F
Locked rotor torque	: 280 %	Service factor	: 1.25
Breakdown torque	: 320 %	Temperature rise	: 80 K
Rated speed	: 1450 rpm	Design	: B

Heating constant

Cooling constant

Rev.	Changes Summary	Performed	Checked	Date
Performed by				
Checked by			Page	Revision
Date	12/04/2022		16 / 21	

THERMAL LIMIT CURVE

Three Phase Induction Motor - Squirrel Cage



Customer : _____

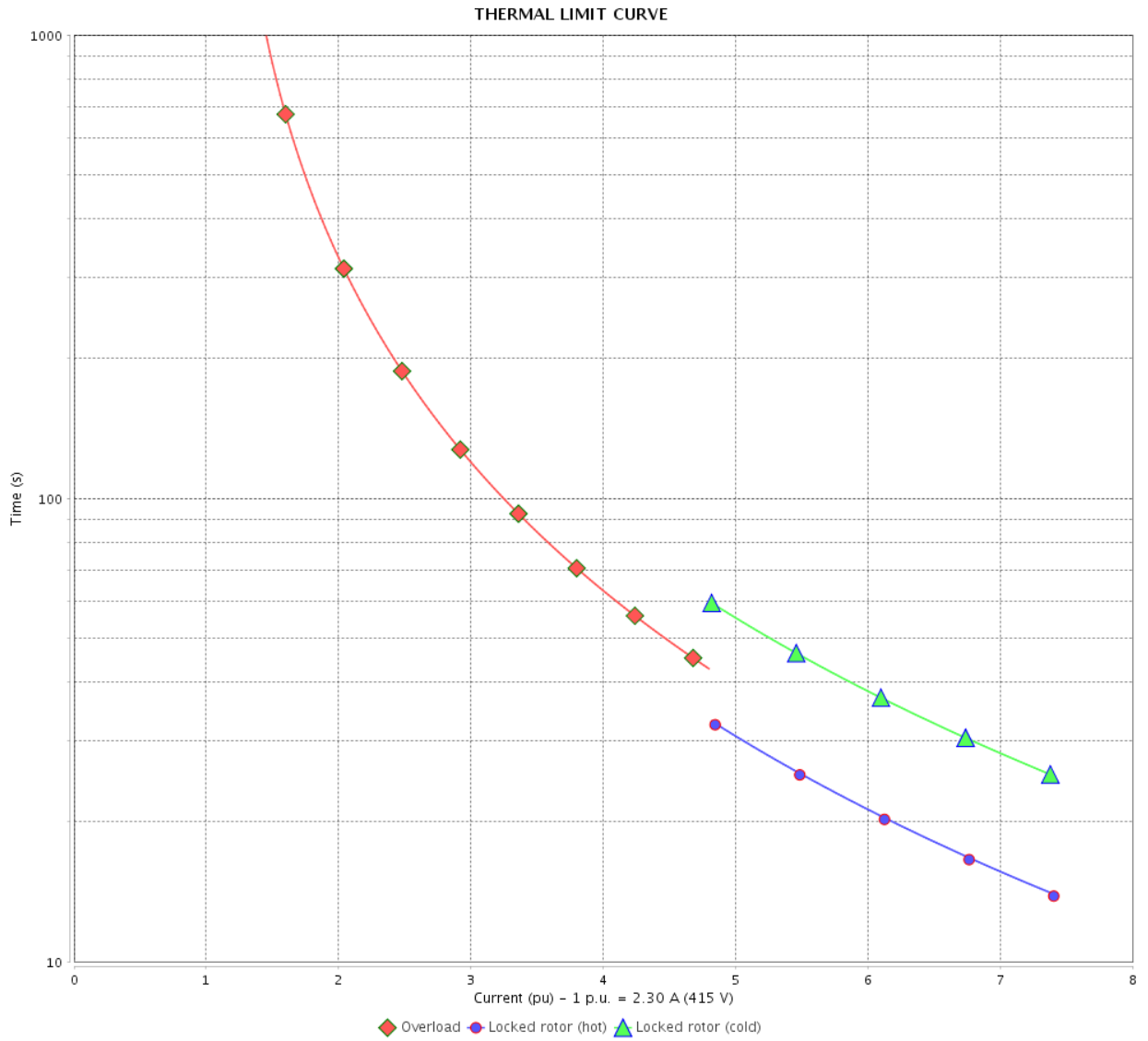

Rev.	Changes Summary	Performed	Checked	Date
Performed by		Page		Revision
Checked by		17 / 21		
Date		12/04/2022		

VFD OPERATION CURVE

Three Phase Induction Motor - Squirrel Cage



Customer : _____

Product line : NEMA Premium Efficiency Three-Phase

Product code : 11523675

Catalog # : 00158ET3E145JM-W22

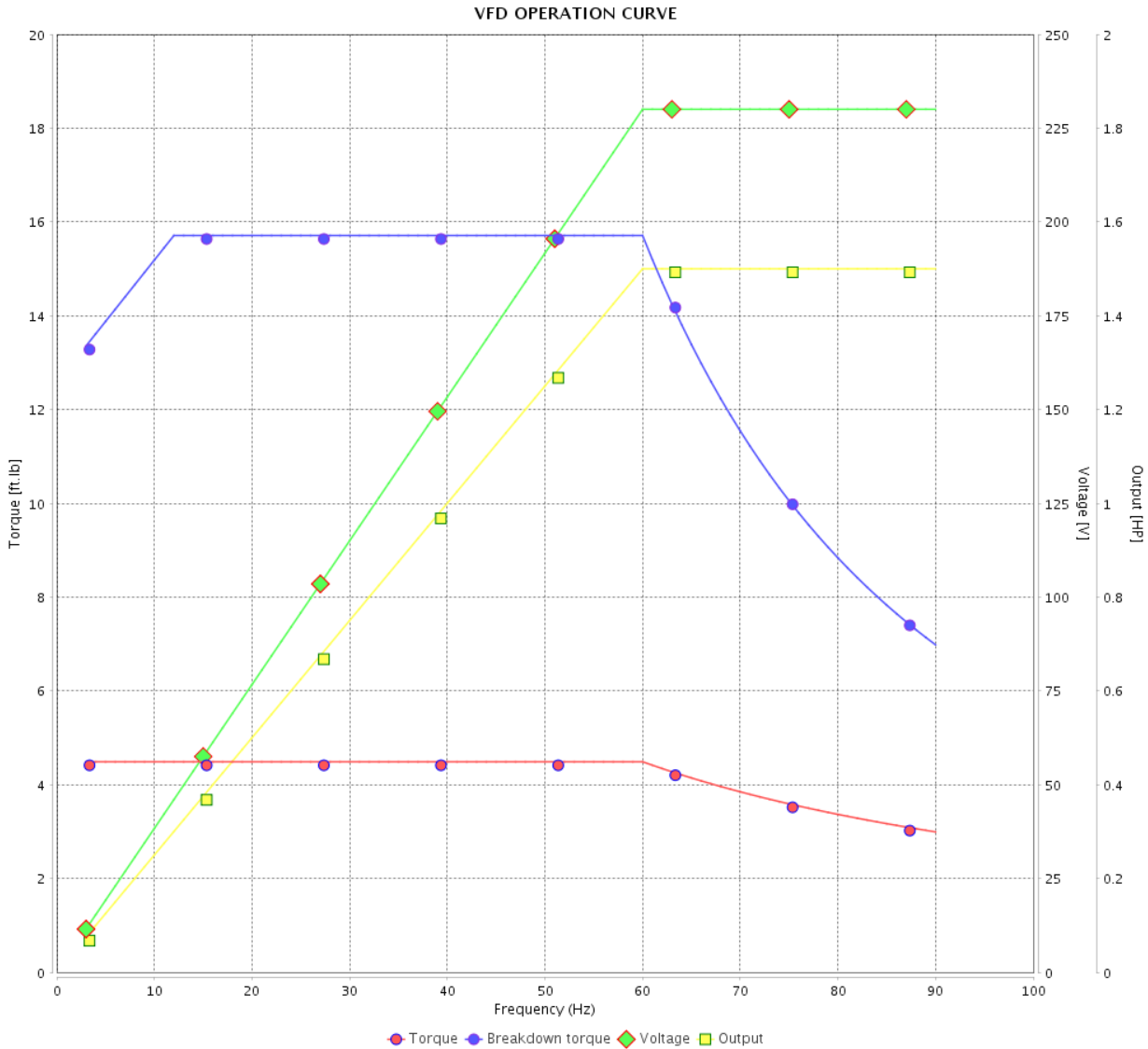

Performance : 230/460 V 60 Hz 4P

Rated current : 4.04/2.02 A
 LRC : 8.4
 Rated torque : 4.49 ft.lb
 Locked rotor torque : 290 %
 Breakdown torque : 350 %
 Rated speed : 1755 rpm

Moment of inertia (J) : 0.1431 sq.ft.lb
 Duty cycle : Cont.(S1)
 Insulation class : F
 Service factor : 1.25
 Temperature rise : 80 K
 Design : B

Rev.	Changes Summary	Performed	Checked	Date
Performed by			Page	Revision
Checked by				
Date				

VFD OPERATION CURVE

Three Phase Induction Motor - Squirrel Cage



Customer :

Product line : NEMA Premium Efficiency Three-Phase

Product code : 11523675

Catalog # : 00158ET3E145JM-W22

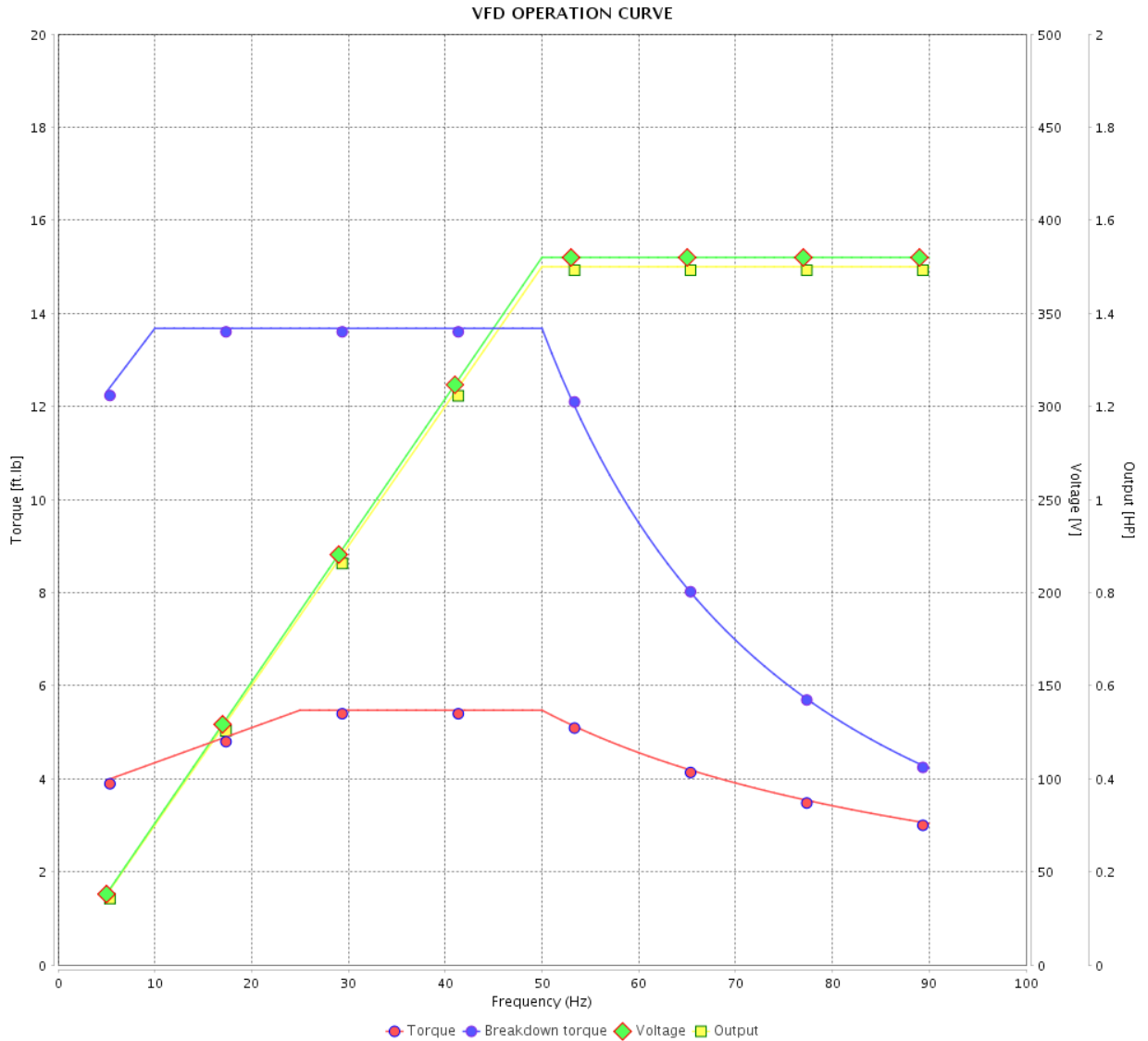

Performance : 380 V 50 Hz 4P IE3

Rated current : 2.42 A
 LRC : 6.4
 Rated torque : 5.47 ft.lb
 Locked rotor torque : 220 %
 Breakdown torque : 250 %
 Rated speed : 1440 rpm

Moment of inertia (J) : 0.1431 sq.ft.lb
 Duty cycle : Cont.(S1)
 Insulation class : F
 Service factor : 1.25
 Temperature rise : 80 K
 Design : B

Rev.	Changes Summary	Performed	Checked	Date
Performed by				Page 19 / 21
Checked by				
Date	12/04/2022			

VFD OPERATION CURVE

Three Phase Induction Motor - Squirrel Cage



Customer : _____

Product line : NEMA Premium Efficiency Three-Phase

Product code : 11523675

Catalog # : 00158ET3E145JM-W22

VFD OPERATION CURVE

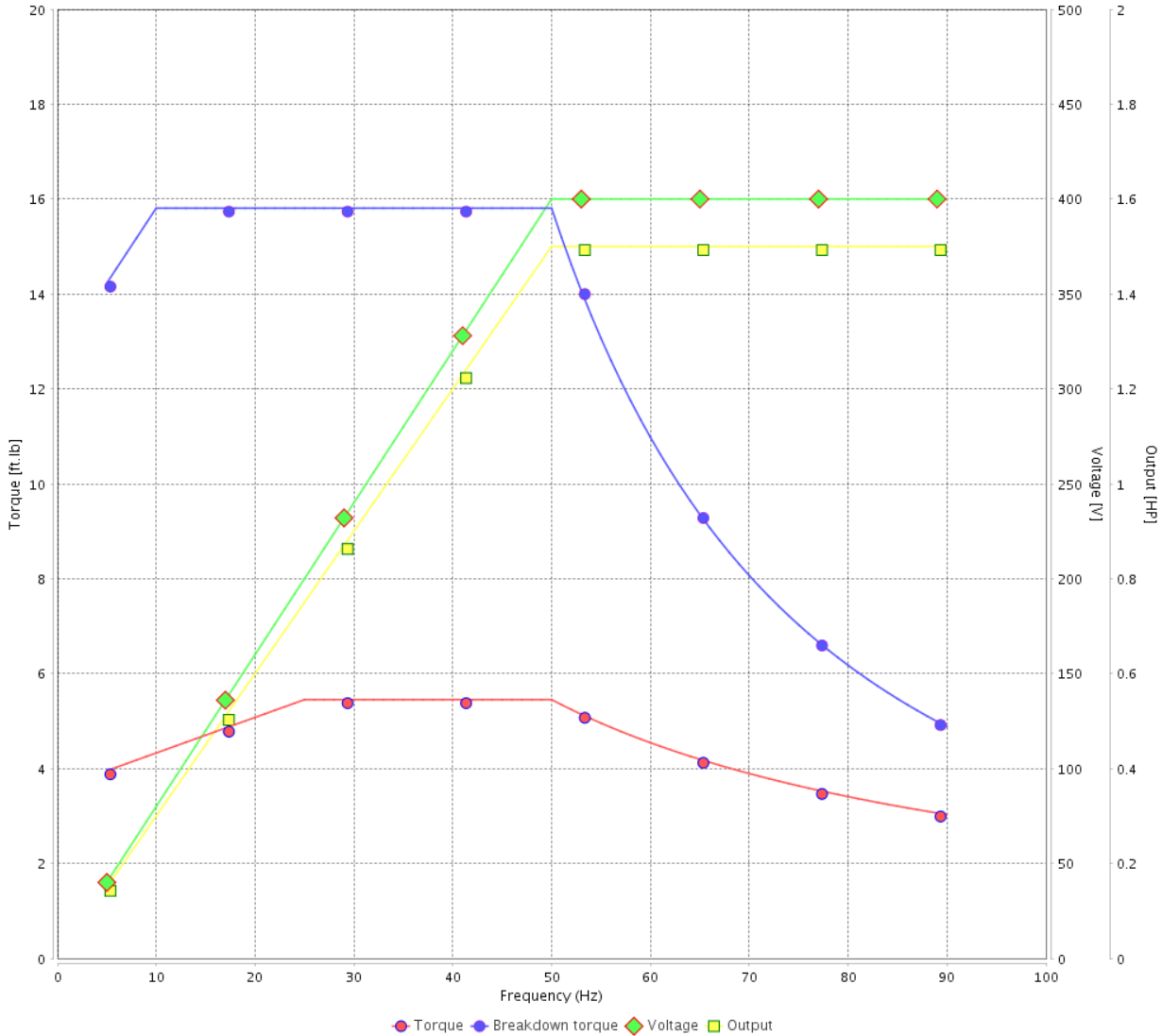

Performance : 400 V 50 Hz 4P IE3

Rated current : 2.33 A
 LRC : 7.0
 Rated torque : 5.45 ft.lb
 Locked rotor torque : 250 %
 Breakdown torque : 290 %
 Rated speed : 1445 rpm

Moment of inertia (J) : 0.1431 sq.ft.lb
 Duty cycle : Cont.(S1)
 Insulation class : F
 Service factor : 1.25
 Temperature rise : 80 K
 Design : B

Rev.	Changes Summary	Performed	Checked	Date
Performed by		Page		Revision
Checked by		20 / 21		
Date	12/04/2022			

VFD OPERATION CURVE

Three Phase Induction Motor - Squirrel Cage



Customer :

Product line : NEMA Premium Efficiency Three-Phase

Product code : 11523675

Catalog # : 00158ET3E145JM-W22

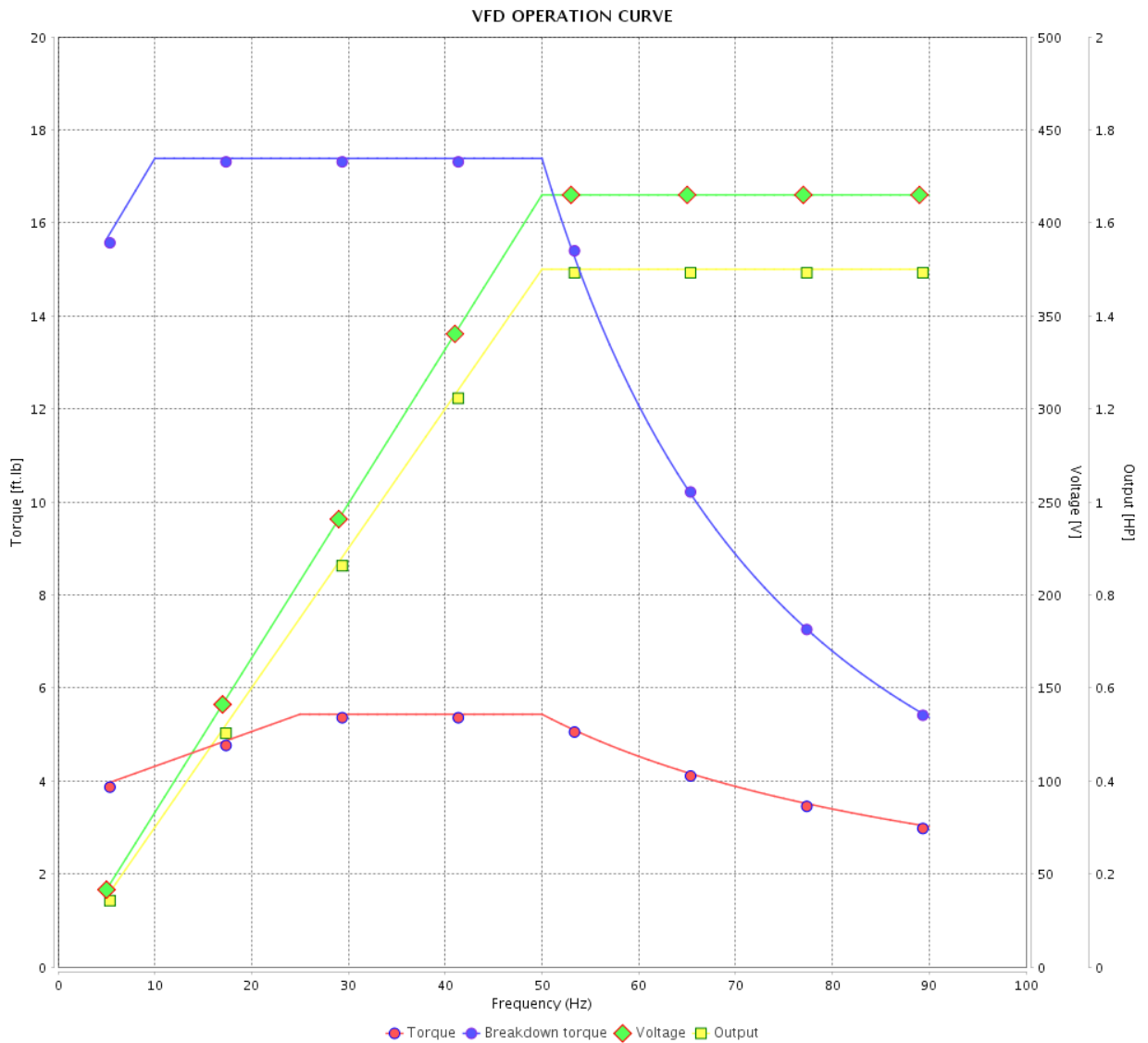

Performance : 415 V 50 Hz 4P IE3

Rated current : 2.30 A
 LRC : 7.4
 Rated torque : 5.43 ft.lb
 Locked rotor torque : 280 %
 Breakdown torque : 320 %
 Rated speed : 1450 rpm

Moment of inertia (J) : 0.1431 sq.ft.lb
 Duty cycle : Cont.(S1)
 Insulation class : F
 Service factor : 1.25
 Temperature rise : 80 K
 Design : B

Rev.	Changes Summary	Performed	Checked	Date
Performed by				Page 21 / 21
Checked by				
Date	12/04/2022			

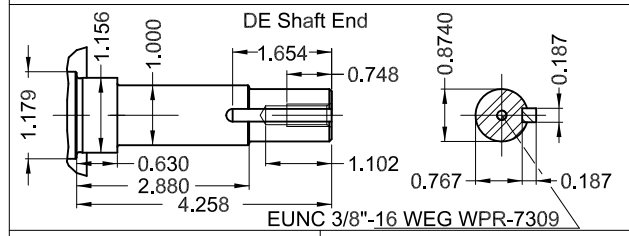
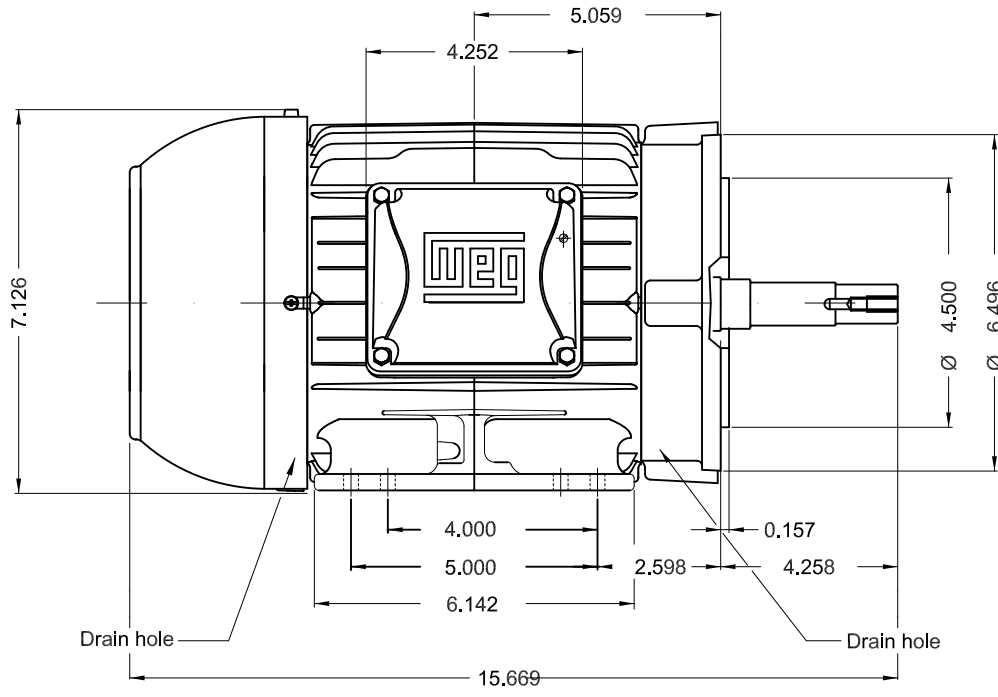
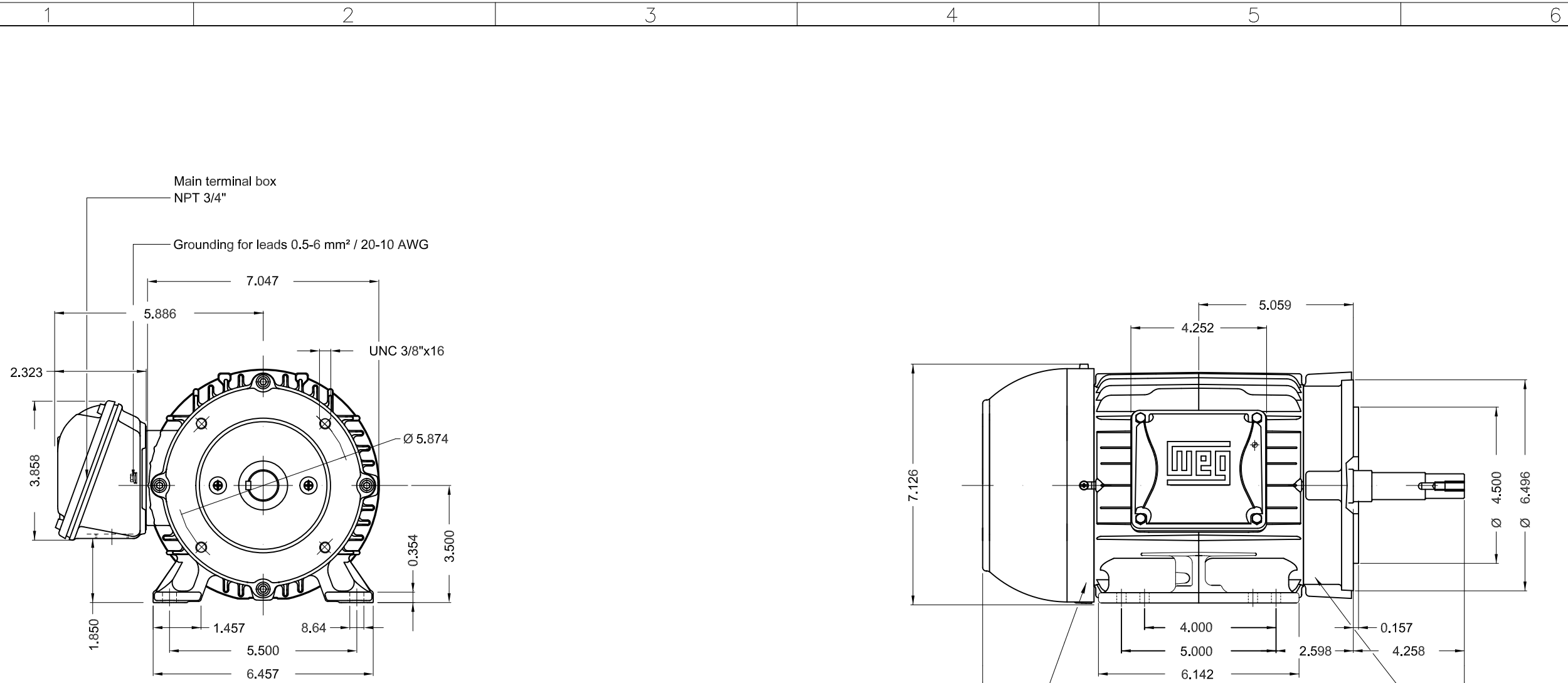

1.5 HP 04 Poles 60 Hz A

ECM	LOC	SUMMARY OF MODIFICATIONS	EXECUTED	CHECKED	RELEASED	DATE	VER
EXECUTED	PIRWBUSER	THREE PH. MOTOR JM/JP/JET PUMP W22 PREM. EFF. FRAME 143/5JM IP55 TEFC					
CHECKED							
RELEASED							
REL DT.	WMO		Jaragua do Sul	Product Engineering	SHEET	1 / 1	

Color RAL 5009
 Painting plan 207A
 Mounting B34R(D)

PREVIEW

WDD

Dimensions in inches XME A3

**W22**

CC029A

® Inverter Duty Motor
Severe Duty

11523675

MADE IN BRAZIL MODEL 00158ET3E145JM-W22

PH 3 | FR 143/5JM | HP(kw) 1.5(1.1) | Hz 60 | SF 1.25 | PF 0.79

V 230/460 | A 4.04/2.02 | RPM 1755 | INS. CL. F ΔT 80 K | IP55

NEMA NOM EFF 86.5 % | DES B | DUTY CONT. | AMB 40°C

ENCL TEFC | SFA 5.05/2.52 | USABLE @208V 4.36 A | SF 1.15 SFA 5.01

1.5HP 1.1kW 50Hz 380V 2.42A 1440RPM SF1.25 EFF 84.1% (IE3) | CODE L

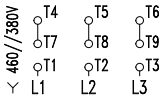
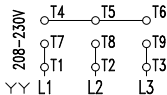

→6206-ZZ

→6204-ZZ

MOBIL POLYREX EM

ALT 1000 m.a.s.l. | 55 Lbs

For 60Hz: Class I, Div 2, Gr. A, B, C and D - T3

Class I, Zone 2, IIC - T3

Class II, Div 2, Gr. F and G - T5

For use on PWM, Gr. A, B, C, D, F and G

VT1000:1, CT20:1, 1.0SF, T4A

C US
Energy Verified3PT9
US LISTEDFOR SAFE AREA
MOD.TE1BFOXON