

# DATA SHEET

## Three Phase Induction Motor - Squirrel Cage



Customer :				
Product line	: JP Pump NEMA Premium Efficiency Three-Phase	Product code :	14808416	
		Catalog # :	00158ET3E145JP-S	
Frame	: 143/5JP	Cooling method	: IC411 - TEFC	
Insulation class	: F	Mounting	: F-1	
Duty cycle	: Cont.(S1)	Rotation <sup>1</sup>	: Both (CW and CCW)	
Ambient temperature	: -20°C to +40°C	Starting method	: Direct On Line	
Altitude	: 1000 m.a.s.l.	Approx. weight <sup>2</sup>	: 37.9 lb	
Protection degree	: IP55	Moment of inertia (J)	: 0.1101 sq.ft.lb	
Design	: B			
Output [HP]	1.5	1.5	1.5	
Poles	4	4	4	
Frequency [Hz]	60	50	50	
Rated voltage [V]	230/460	190/380	220/415	
Rated current [A]	4.04/2.02	4.82/2.41	4.38/2.32	
L. R. Amperes [A]	33.1/16.6	29.4/14.7	29.3/15.5	
LRC [A]	8.2x(Code K)	6.1x(Code H)	6.7x(Code J)	
No load current [A]	2.17/1.08	2.13/1.07	2.20/1.17	
Rated speed [RPM]	1750	1420	1430	
Slip [%]	2.78	5.33	4.67	
Rated torque [ft.lb]	4.50	5.55	5.51	
Locked rotor torque [%]	270	210	240	
Breakdown torque [%]	300	250	280	
Service factor		1.15	1.15	
Temperature rise	80 K	105 K	80 K	
Locked rotor time	37s (cold) 21s (hot)	0s (cold) 0s (hot)	0s (cold) 0s (hot)	
Noise level <sup>2</sup>	52.0 dB(A)	49.0 dB(A)	49.0 dB(A)	
Efficiency (%)	25%	85.2	85.0	
	50%	85.5	84.2	
	75%	86.5	84.9	
	100%	86.5	83.6	
Power Factor	25%	0.35	0.37	
	50%	0.59	0.62	
	75%	0.72	0.75	
	100%	0.79	0.82	
Bearing type	: <u>Drive end</u> 6206 ZZ <u>Non drive end</u> 6203 ZZ	Foundation loads		
Sealing	: V'Ring Without Bearing Seal	Max. traction	: 115 lb	
		Max. compression	: 153 lb	
Lubrication interval	: -			
Lubricant amount	: -			
Lubricant type	: Mobil Polyrex EM			
Notes USABLE @208V 4.47A SF 1.00 SFA 4.47A				
This revision replaces and cancel the previous one, which must be eliminated. (1) Looking the motor from the shaft end. (2) Measured at 1m and with tolerance of +3dB(A). (3) Approximate weight subject to changes after manufacturing process. (4) At 100% of full load.		These are average values based on tests with sinusoidal power supply, subject to the tolerances stipulated in NEMA MG-1.		
Rev.	Changes Summary	Performed	Checked	Date
Performed by				
Checked by			Page	Revision
Date	12/04/2022		1 / 16	

# TORQUE AND CURRENT VS SPEED CURVE

## Three Phase Induction Motor - Squirrel Cage



Customer :

Product line : JP Pump NEMA Premium  
Efficiency Three-Phase

Product code : 14808416

Catalog # : 00158ET3E145JP-S

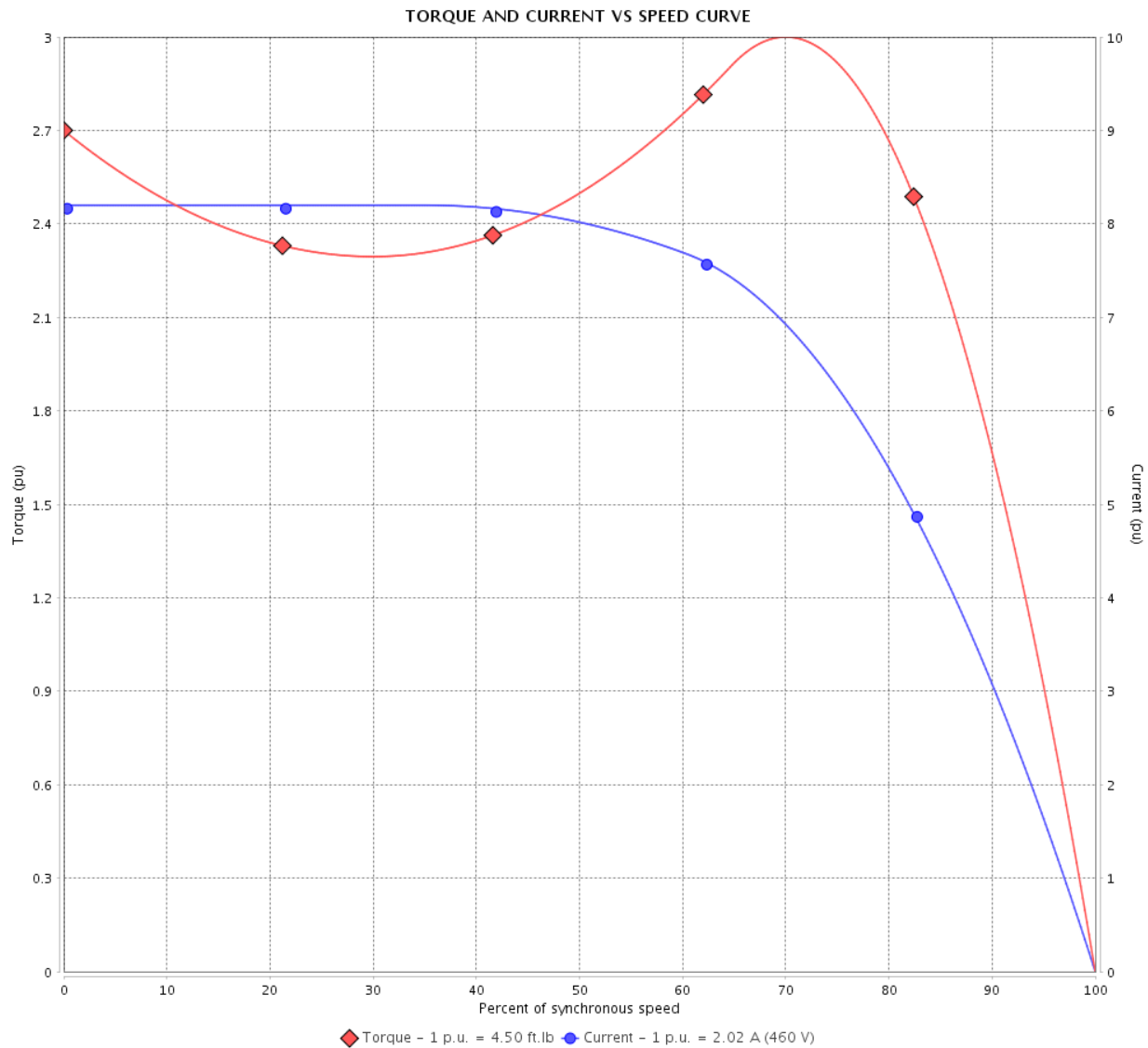

Performance : 230/460 V 60 Hz 4P

Rated current	: 4.04/2.02 A	Moment of inertia (J)	: 0.1101 sq.ft.lb
LRC	: 8.2	Duty cycle	: Cont.(S1)
Rated torque	: 4.50 ft.lb	Insulation class	: F
Locked rotor torque	: 270 %	Service factor	:
Breakdown torque	: 300 %	Temperature rise	: 80 K
Rated speed	: 1750 rpm	Design	: B

Locked rotor time : 37s (cold) 21s (hot)

Rev.	Changes Summary	Performed	Checked	Date
Performed by			Page	Revision
Checked by				
Date	12/04/2022			
			2 / 16	

# TORQUE AND CURRENT VS SPEED CURVE



## Three Phase Induction Motor - Squirrel Cage

Customer :

Product line : JP Pump NEMA Premium Efficiency Three-Phase

Product code : 14808416

Catalog # : 00158ET3E145JP-S

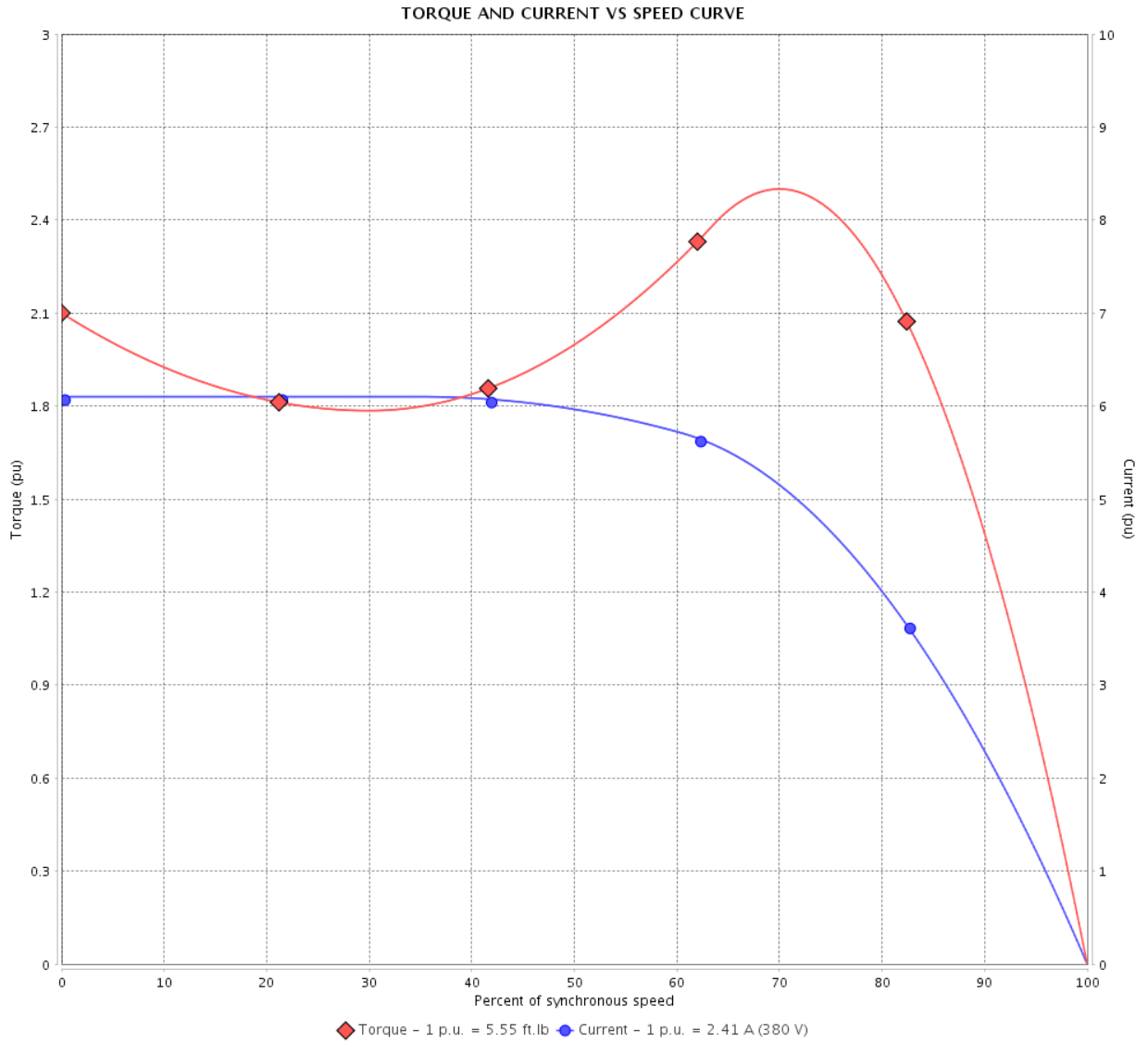

Performance : 190/380 V 50 Hz 4P

Rated current : 4.82/2.41 A  
 LRC : 6.1  
 Rated torque : 5.55 ft.lb  
 Locked rotor torque : 210 %  
 Breakdown torque : 250 %  
 Rated speed : 1420 rpm

Moment of inertia (J) : 0.1101 sq.ft.lb  
 Duty cycle : Cont.(S1)  
 Insulation class : F  
 Service factor : 1.15  
 Temperature rise : 105 K  
 Design : B

Locked rotor time : 0s (cold) 0s (hot)

Rev.	Changes Summary	Performed	Checked	Date
Performed by			Page 3 / 16	Revision
Checked by				
Date	12/04/2022			

# TORQUE AND CURRENT VS SPEED CURVE

Three Phase Induction Motor - Squirrel Cage



Customer :

Product line : JP Pump NEMA Premium  
Efficiency Three-Phase

Product code : 14808416

Catalog # : 00158ET3E145JP-S

TORQUE AND CURRENT VS SPEED CURVE

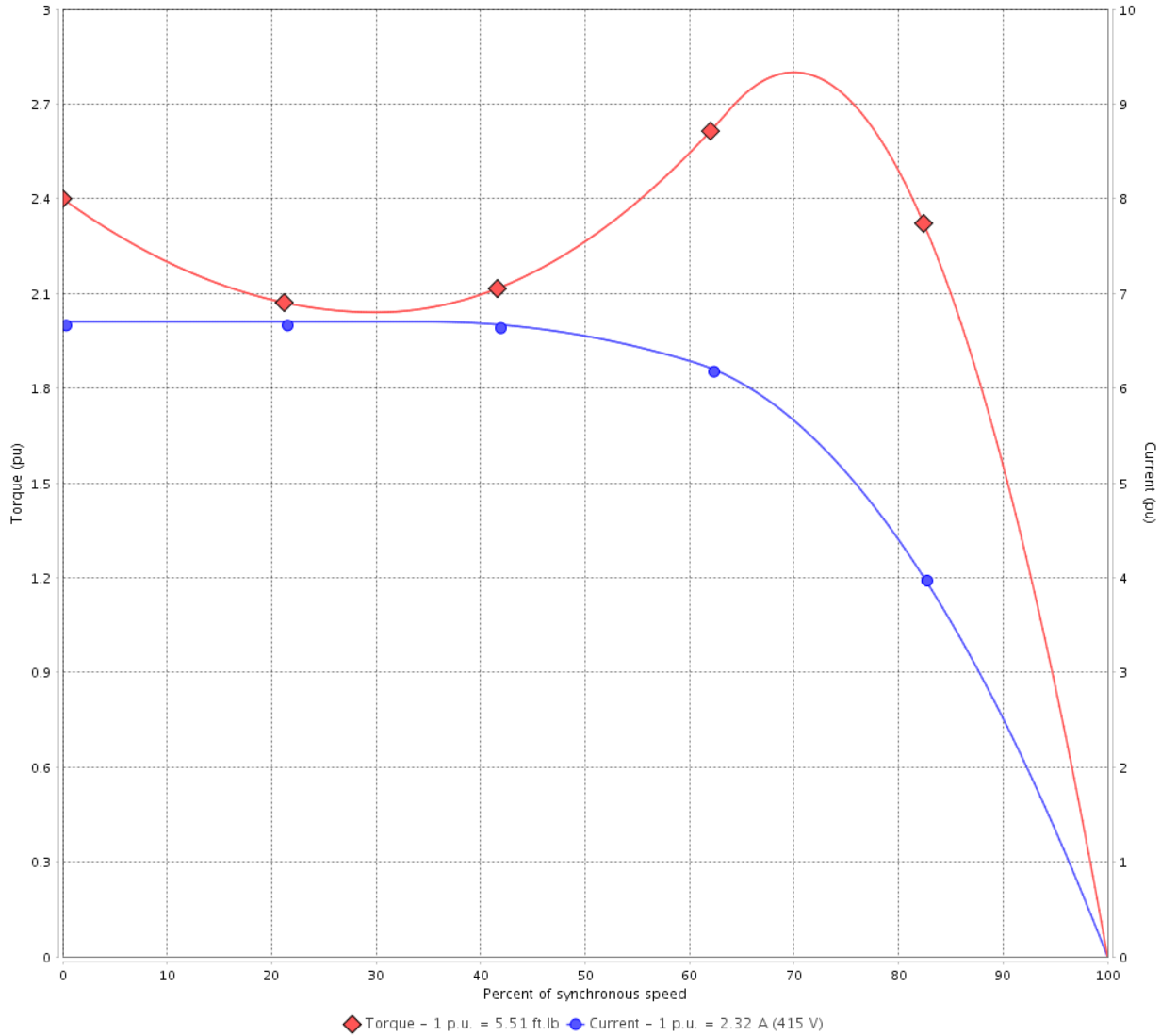

Performance : 220/415 V 50 Hz 4P

Rated current : 4.38/2.32 A  
LRC : 6.7  
Rated torque : 5.51 ft.lb  
Locked rotor torque : 240 %  
Breakdown torque : 280 %  
Rated speed : 1430 rpm

Moment of inertia (J) : 0.1101 sq.ft.lb  
Duty cycle : Cont.(S1)  
Insulation class : F  
Service factor : 1.15  
Temperature rise : 80 K  
Design : B

Locked rotor time : 0s (cold) 0s (hot)

Rev.	Changes Summary	Performed	Checked	Date
Performed by			Page 4 / 16	Revision
Checked by				
Date	12/04/2022			

# LOAD PERFORMANCE CURVE

## Three Phase Induction Motor - Squirrel Cage



Customer :

Product line : JP Pump NEMA Premium  
Efficiency Three-Phase

Product code : 14808416

Catalog # : 00158ET3E145JP-S

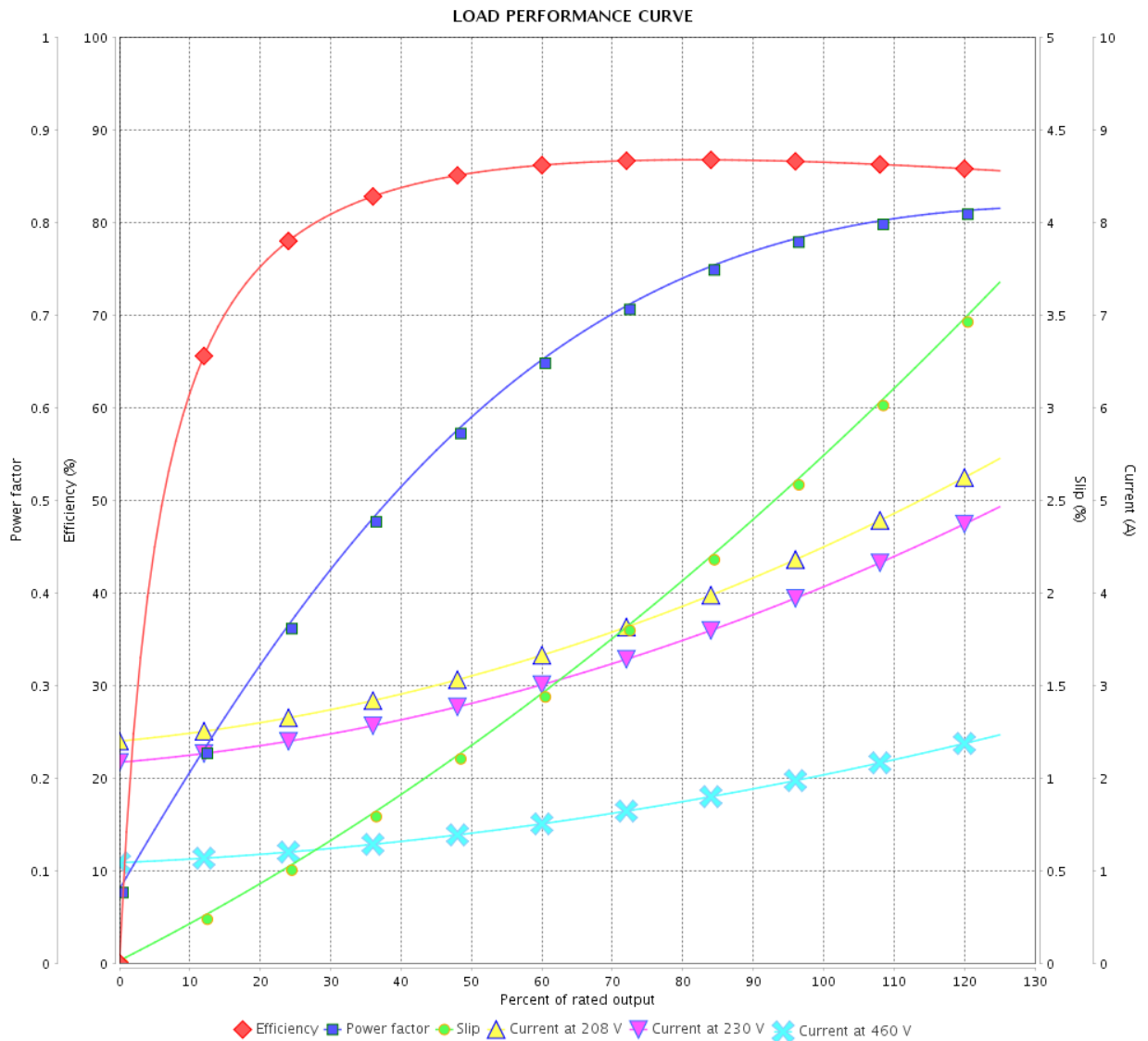

Performance : 230/460 V 60 Hz 4P

Rated current : 4.04/2.02 A  
 LRC : 8.2  
 Rated torque : 4.50 ft.lb  
 Locked rotor torque : 270 %  
 Breakdown torque : 300 %  
 Rated speed : 1750 rpm

Moment of inertia (J) : 0.1101 sq.ft.lb  
 Duty cycle : Cont.(S1)  
 Insulation class : F  
 Service factor :  
 Temperature rise : 80 K  
 Design : B

Rev.	Changes Summary	Performed	Checked	Date
Performed by			Page	Revision
Checked by				
Date				

# LOAD PERFORMANCE CURVE

Three Phase Induction Motor - Squirrel Cage



Customer :

Product line : JP Pump NEMA Premium  
Efficiency Three-Phase

Product code : 14808416

Catalog # : 00158ET3E145JP-S

LOAD PERFORMANCE CURVE

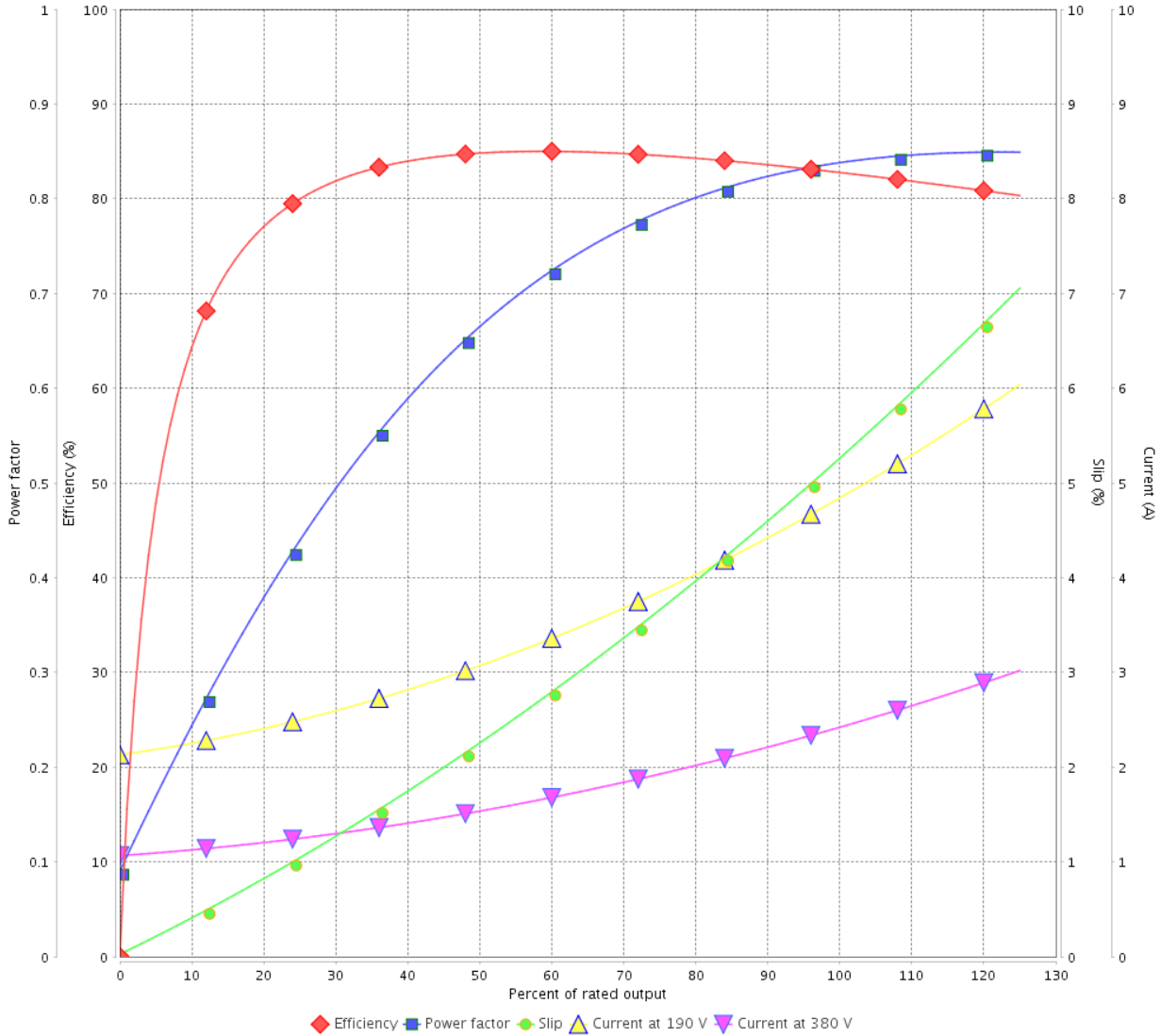

Performance : 190/380 V 50 Hz 4P

Rated current : 4.82/2.41 A  
 LRC : 6.1  
 Rated torque : 5.55 ft.lb  
 Locked rotor torque : 210 %  
 Breakdown torque : 250 %  
 Rated speed : 1420 rpm

Moment of inertia (J) : 0.1101 sq.ft.lb  
 Duty cycle : Cont.(S1)  
 Insulation class : F  
 Service factor : 1.15  
 Temperature rise : 105 K  
 Design : B

Rev.	Changes Summary	Performed	Checked	Date
Performed by			Page	Revision
Checked by			6 / 16	
Date	12/04/2022			

# LOAD PERFORMANCE CURVE

## Three Phase Induction Motor - Squirrel Cage



Customer : \_\_\_\_\_

Product line : JP Pump NEMA Premium  
Efficiency Three-Phase

Product code : 14808416

Catalog # : 00158ET3E145JP-S

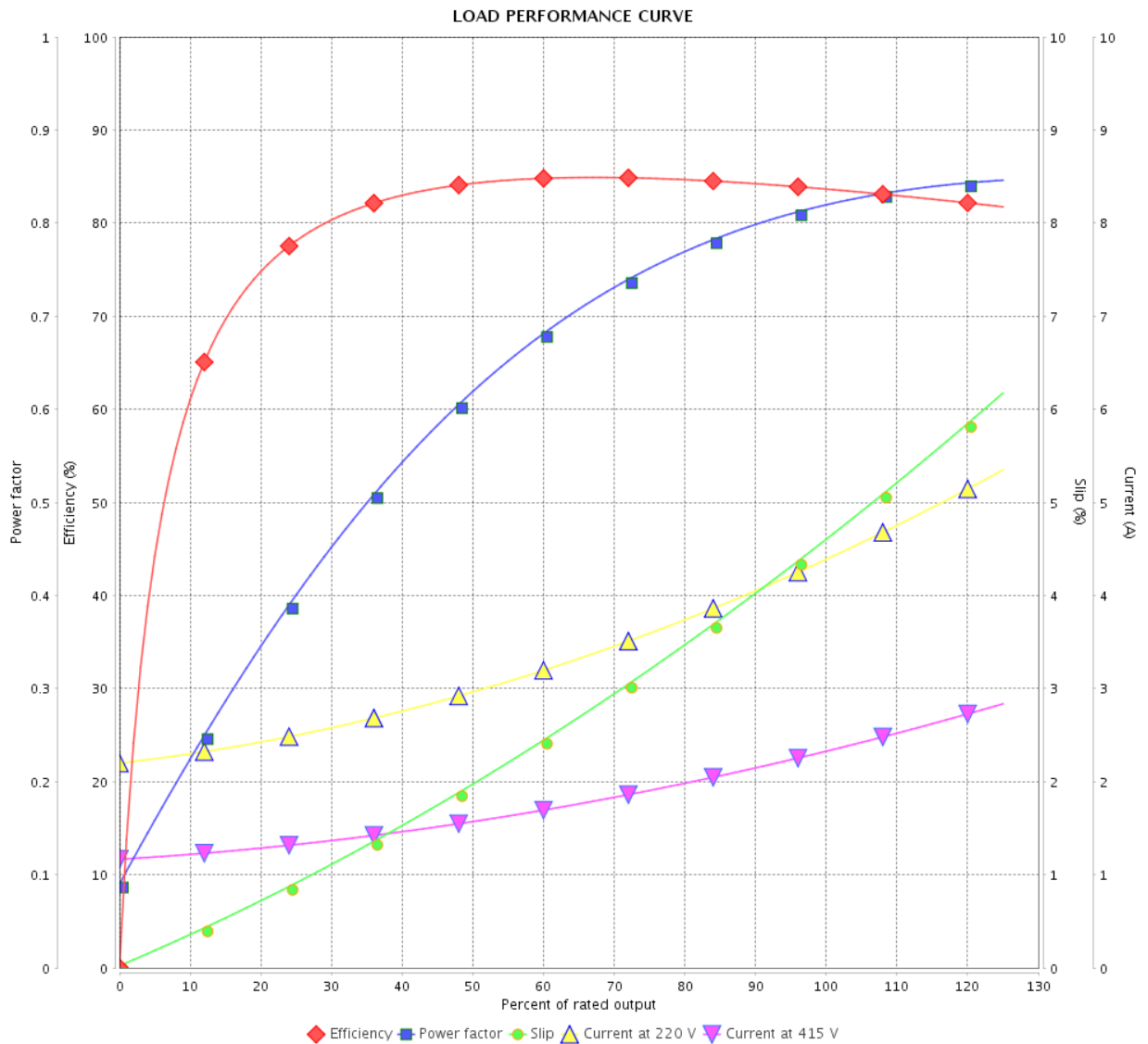

Performance : 220/415 V 50 Hz 4P

Rated current : 4.38/2.32 A  
 LRC : 6.7  
 Rated torque : 5.51 ft.lb  
 Locked rotor torque : 240 %  
 Breakdown torque : 280 %  
 Rated speed : 1430 rpm

Moment of inertia (J) : 0.1101 sq.ft.lb  
 Duty cycle : Cont.(S1)  
 Insulation class : F  
 Service factor : 1.15  
 Temperature rise : 80 K  
 Design : B

Rev.	Changes Summary	Performed	Checked	Date
Performed by			Page	Revision
Checked by				
Date				

# THERMAL LIMIT CURVE



## Three Phase Induction Motor - Squirrel Cage

Customer :

Product line : JP Pump NEMA Premium  
Efficiency Three-Phase

Product code : 14808416

Catalog # : 00158ET3E145JP-S

Performance : 230/460 V 60 Hz 4P

Rated current : 4.04/2.02 A  
LRC : 8.2  
Rated torque : 4.50 ft.lb  
Locked rotor torque : 270 %  
Breakdown torque : 300 %  
Rated speed : 1750 rpm

Moment of inertia (J) : 0.1101 sq.ft.lb  
Duty cycle : Cont.(S1)  
Insulation class : F  
Service factor :  
Temperature rise : 80 K  
Design : B

Heating constant

Cooling constant

Rev.	Changes Summary	Performed	Checked	Date
Performed by				
Checked by			Page	Revision
Date	12/04/2022		8 / 16	



# THERMAL LIMIT CURVE

Three Phase Induction Motor - Squirrel Cage



Customer : \_\_\_\_\_

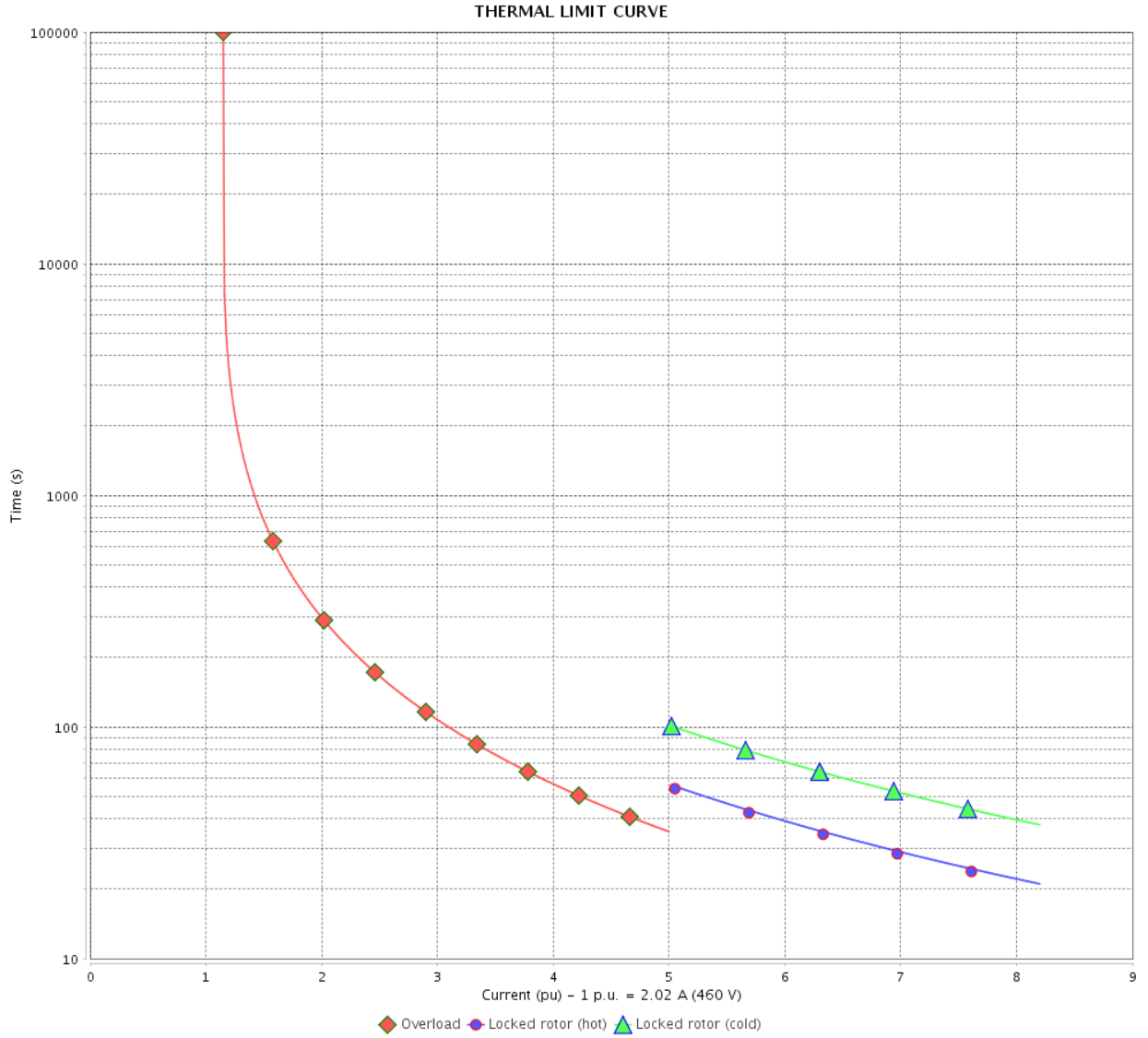

Rev.	Changes Summary	Performed	Checked	Date
Performed by				
Checked by				
Date				
			Page	Revision
			9 / 16	

# THERMAL LIMIT CURVE



## Three Phase Induction Motor - Squirrel Cage

Customer :

Product line : JP Pump NEMA Premium  
Efficiency Three-Phase

Product code : 14808416

Catalog # : 00158ET3E145JP-S

Performance : 190/380 V 50 Hz 4P

Rated current : 4.82/2.41 A  
LRC : 6.1  
Rated torque : 5.55 ft.lb  
Locked rotor torque : 210 %  
Breakdown torque : 250 %  
Rated speed : 1420 rpm

Moment of inertia (J) : 0.1101 sq.ft.lb  
Duty cycle : Cont.(S1)  
Insulation class : F  
Service factor : 1.15  
Temperature rise : 105 K  
Design : B

Heating constant

Cooling constant

Rev.	Changes Summary	Performed	Checked	Date
Performed by				
Checked by			Page	Revision
Date	12/04/2022		10 / 16	

# THERMAL LIMIT CURVE

Three Phase Induction Motor - Squirrel Cage



Customer : \_\_\_\_\_

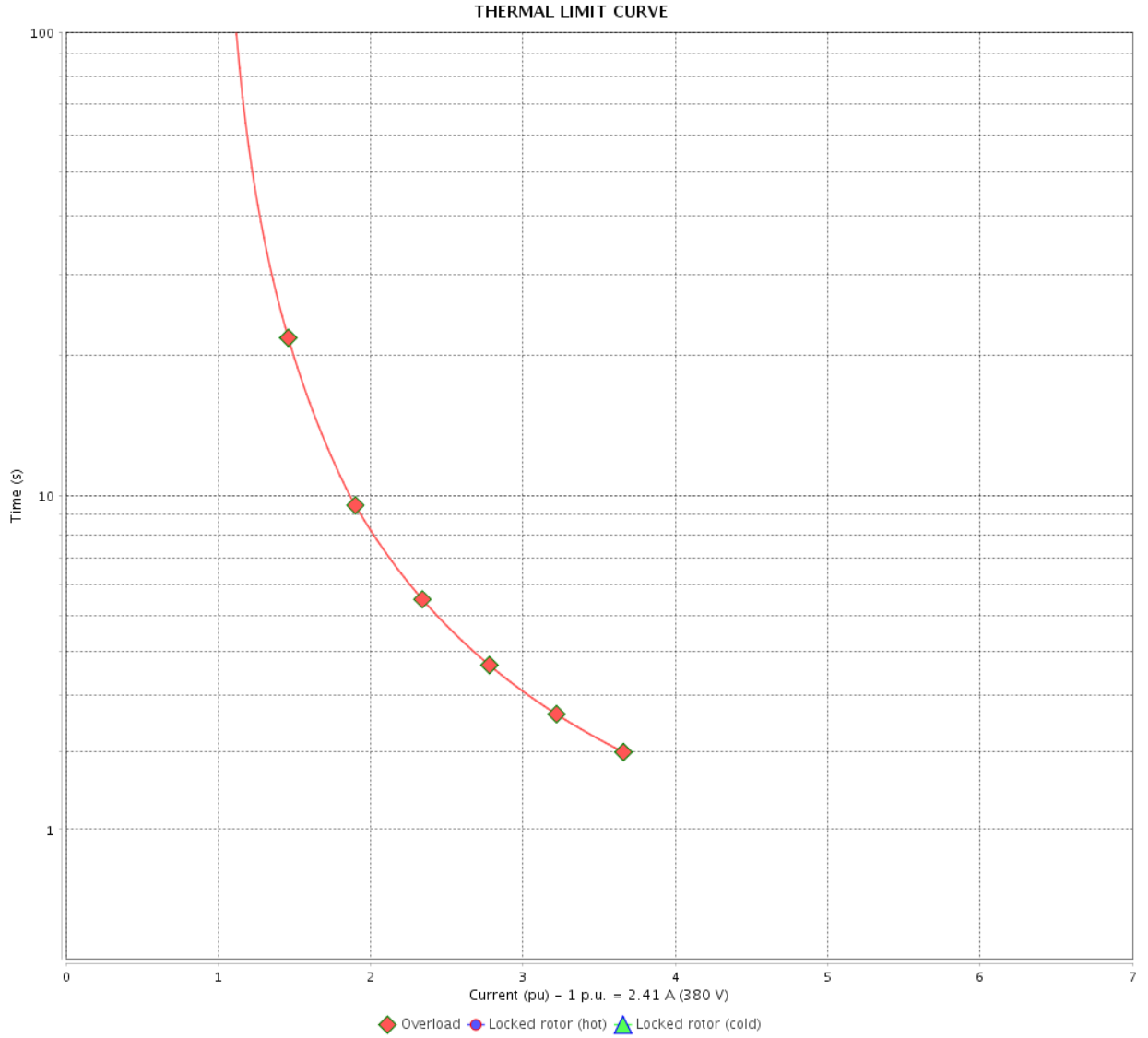

Rev.	Changes Summary	Performed	Checked	Date
Performed by		Page		Revision
Checked by		11 / 16		
Date		12/04/2022		

# THERMAL LIMIT CURVE



## Three Phase Induction Motor - Squirrel Cage

Customer :

Product line : JP Pump NEMA Premium  
Efficiency Three-Phase

Product code : 14808416

Catalog # : 00158ET3E145JP-S

Performance : 220/415 V 50 Hz 4P

Rated current : 4.38/2.32 A  
LRC : 6.7  
Rated torque : 5.51 ft.lb  
Locked rotor torque : 240 %  
Breakdown torque : 280 %  
Rated speed : 1430 rpm

Moment of inertia (J) : 0.1101 sq.ft.lb  
Duty cycle : Cont.(S1)  
Insulation class : F  
Service factor : 1.15  
Temperature rise : 80 K  
Design : B

Heating constant

Cooling constant

Rev.	Changes Summary	Performed	Checked	Date
Performed by				
Checked by			Page	Revision
Date	12/04/2022		12 / 16	

# THERMAL LIMIT CURVE

Three Phase Induction Motor - Squirrel Cage



Customer : \_\_\_\_\_

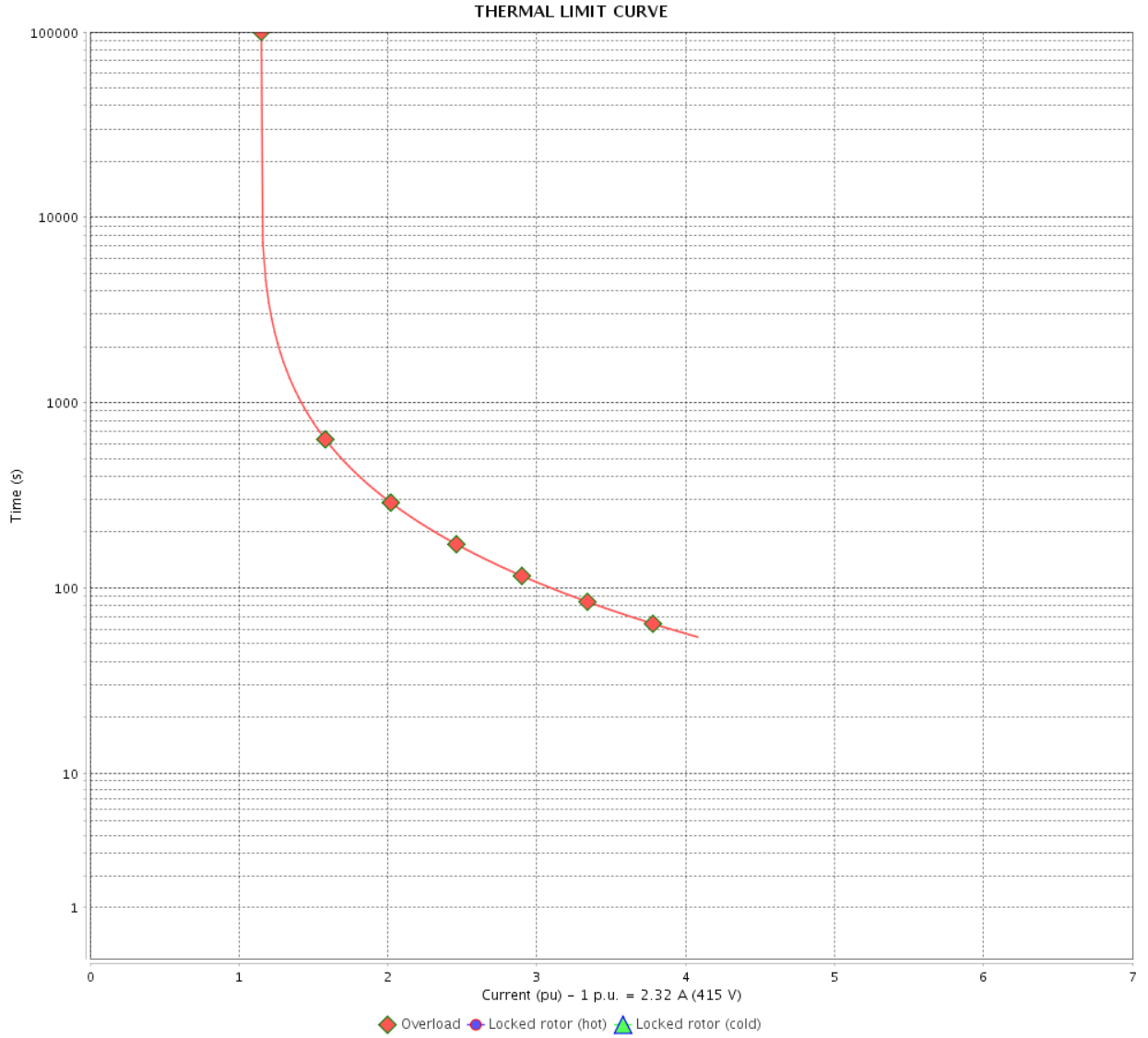

Rev.	Changes Summary	Performed	Checked	Date
Performed by		Page		Revision
Checked by		13 / 16		
Date		12/04/2022		

# VFD OPERATION CURVE

Three Phase Induction Motor - Squirrel Cage



Customer :

Product line : JP Pump NEMA Premium Efficiency Three-Phase

Product code : 14808416

Catalog # : 00158ET3E145JP-S

VFD OPERATION CURVE

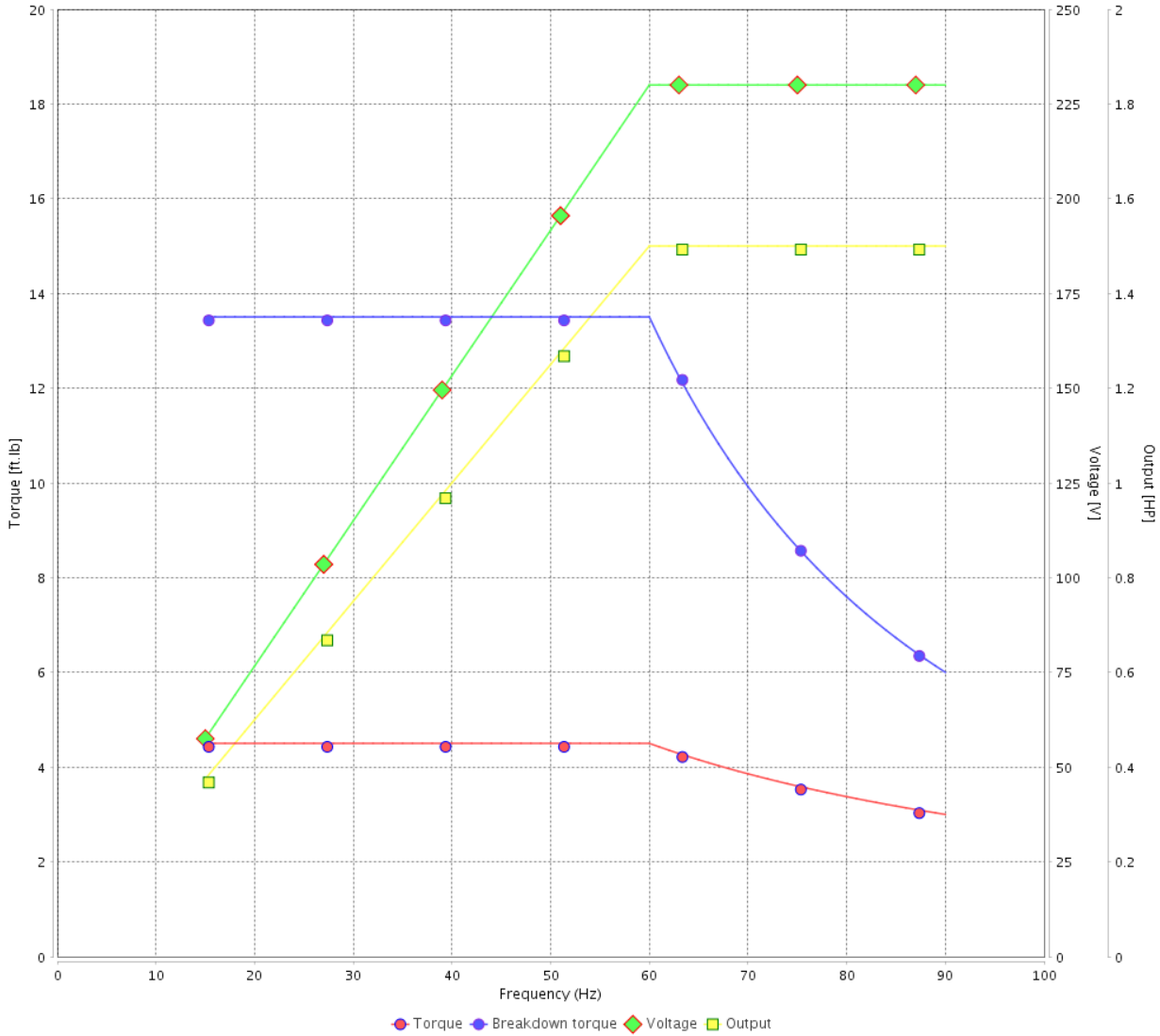

Performance : 230/460 V 60 Hz 4P

Rated current : 4.04/2.02 A  
 LRC : 8.2  
 Rated torque : 4.50 ft.lb  
 Locked rotor torque : 270 %  
 Breakdown torque : 300 %  
 Rated speed : 1750 rpm

Moment of inertia (J) : 0.1101 sq.ft.lb  
 Duty cycle : Cont.(S1)  
 Insulation class : F  
 Service factor :  
 Temperature rise : 80 K  
 Design : B

Rev.	Changes Summary	Performed	Checked	Date
Performed by			Page	Revision
Checked by				
Date				

# VFD OPERATION CURVE

Three Phase Induction Motor - Squirrel Cage



Customer :

Product line : JP Pump NEMA Premium  
Efficiency Three-Phase

Product code : 14808416

Catalog # : 00158ET3E145JP-S

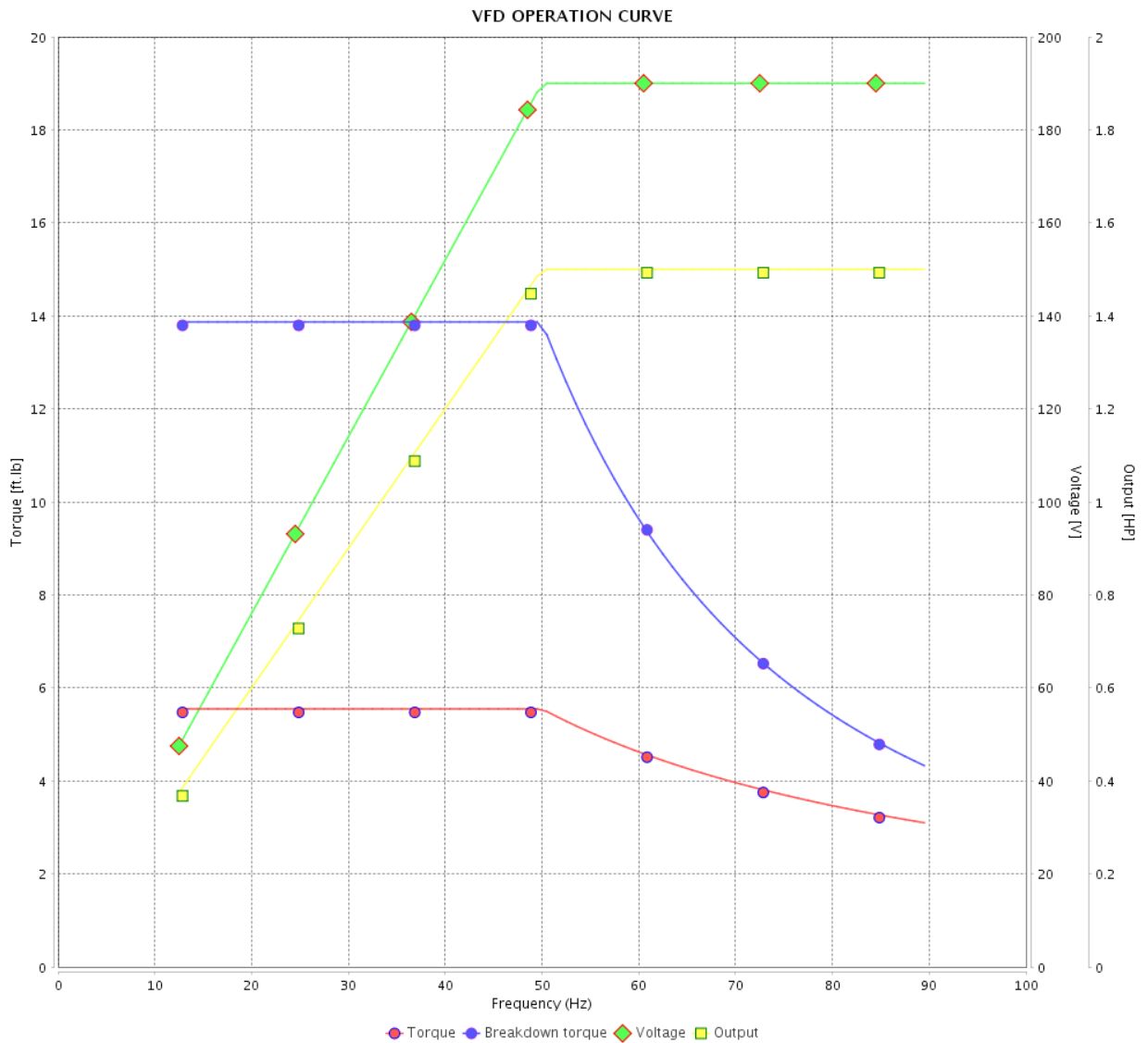

Performance : 190/380 V 50 Hz 4P

Rated current : 4.82/2.41 A  
LRC : 6.1  
Rated torque : 5.55 ft.lb  
Locked rotor torque : 210 %  
Breakdown torque : 250 %  
Rated speed : 1420 rpm

Moment of inertia (J) : 0.1101 sq.ft.lb  
Duty cycle : Cont.(S1)  
Insulation class : F  
Service factor : 1.15  
Temperature rise : 105 K  
Design : B

Rev.	Changes Summary	Performed	Checked	Date
Performed by				Page 15 / 16
Checked by				
Date	12/04/2022			

# VFD OPERATION CURVE

Three Phase Induction Motor - Squirrel Cage



Customer :

Product line : JP Pump NEMA Premium Efficiency Three-Phase

Product code : 14808416

Catalog # : 00158ET3E145JP-S

VFD OPERATION CURVE

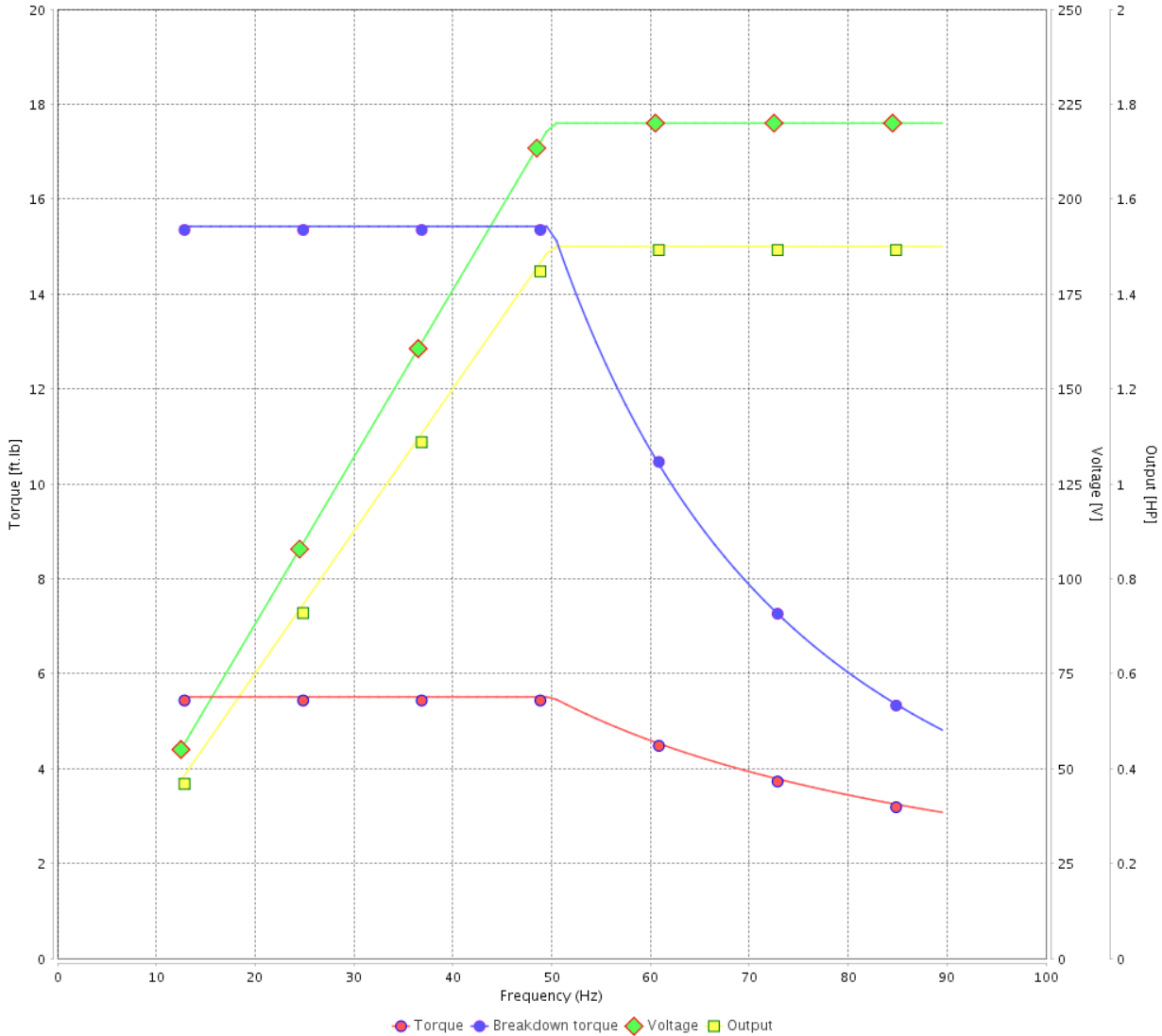

Performance : 220/415 V 50 Hz 4P

Rated current : 4.38/2.32 A  
 LRC : 6.7  
 Rated torque : 5.51 ft.lb  
 Locked rotor torque : 240 %  
 Breakdown torque : 280 %  
 Rated speed : 1430 rpm

Moment of inertia (J) : 0.1101 sq.ft.lb  
 Duty cycle : Cont.(S1)  
 Insulation class : F  
 Service factor : 1.15  
 Temperature rise : 80 K  
 Design : B

Rev.	Changes Summary	Performed	Checked	Date
Performed by			Page 16 / 16	Revision
Checked by				
Date	12/04/2022			



1 2 3 4 5 6

A

B

C

D

E

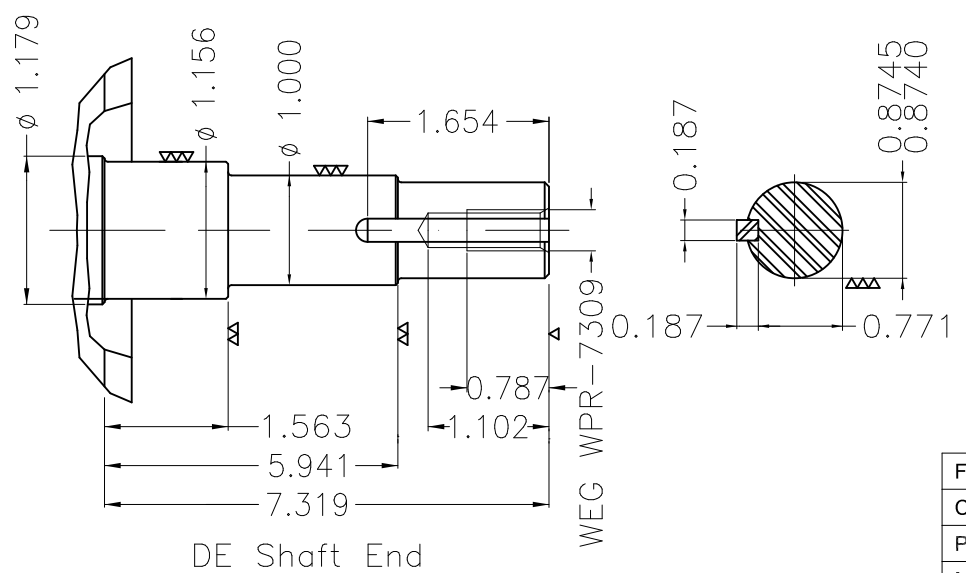
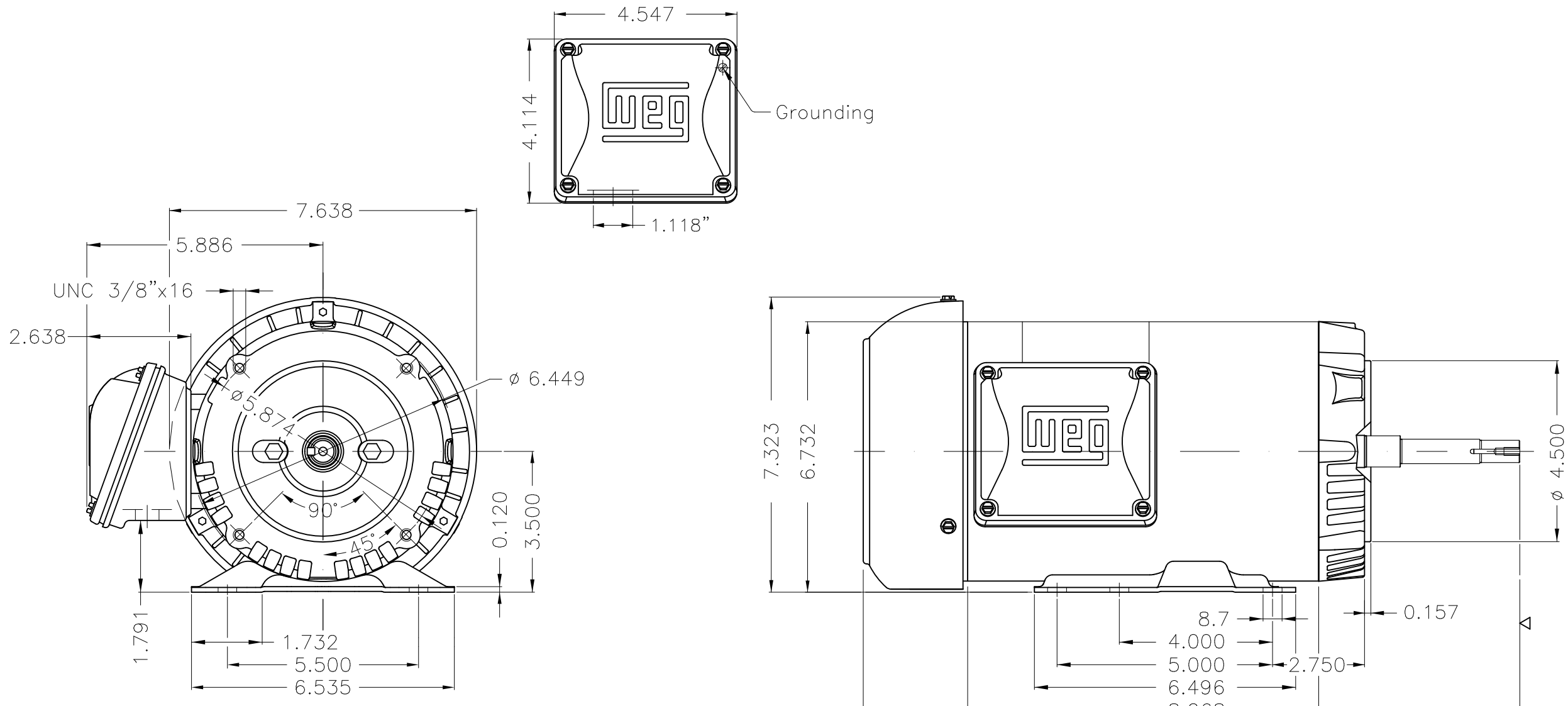

EUNC 3/8"-16 WEG WPR-7309

Fan cover - steel plate									
Color Munsell N 1 matte black									
Painting plan 207N									
Mounting F-1/B34R(D)									
ECM	LOC	SUMMARY OF MODIFICATIONS			EXECUTED	CHECKED	RELEASED	DATE	VER
EXECUTED	PIRBUSER	THREE PH. MOTOR ROLLED STEEL CLOSE COUPLED PUMP JP 5/50 PRE-LETS							
CHECKED		FRAME 143/5JP IP55 TEFC							
RELEASED									
REL DT.		WMO	Jaragua do Sul	Product Engineering					

1.5 HP 04 Poles 60 Hz

