

DATA SHEET

Three Phase Induction Motor - Squirrel Cage



Customer :		
Product line	: Premium Efficiency Three-Phase	
Product code :	13373691	
Catalog # :	002180T3E56CFL-S	
Frame	: 56C	
Insulation class	: F	
Duty cycle	: Cont.(S1)	
Ambient temperature	: -20°C to +40°C	
Altitude	: 1000 m.a.s.l.	
Design	: A	
Cooling method	: IC01 - ODP	
Mounting	: F-1	
Rotation ¹	: Both (CW and CCW)	
Starting method	: Direct On Line	
Approx. weight ²	: 36.8 lb	
Moment of inertia (J)	: 0.1168 sq.ft.lb	
Output [HP]	2	
Poles	4	
Frequency [Hz]	60	
Rated voltage [V]	230/460	
Rated current [A]	5.38/2.69	
L. R. Amperes [A]	41.4/20.7	
LRC [A]	7.7x(Code K)	
No load current [A]	2.75/1.38	
Rated speed [RPM]	1740	
Slip [%]	3.33	
Rated torque [ft.lb]	6.04	
Locked rotor torque [%]	260	
Breakdown torque [%]	320	
Service factor	1.00	
Temperature rise	80 K	
Locked rotor time	30s (cold) 17s (hot)	
Noise level ²	52.0 dB(A)	
Efficiency (%)	25%	85.2
	50%	85.5
	75%	86.5
	100%	86.5
Power Factor	25%	0.36
	50%	0.61
	75%	0.74
	100%	0.81
Bearing type	: Drive end 6204 ZZ Non drive end 6202 ZZ	
Sealing	: Without Without Bearing Seal Bearing Seal	
Lubrication interval	: - -	
Lubricant amount	: - -	
Lubricant type	: Mobil Polyrex EM	
Foundation loads	Max. traction : 170 lb	
	Max. compression : 207 lb	
Notes		
USABLE @208V 5.95A SF 1.00 SFA 5.95A		
This revision replaces and cancel the previous one, which must be eliminated.		
(1) Looking the motor from the shaft end.		
(2) Measured at 1m and with tolerance of +3dB(A).		
(3) Approximate weight subject to changes after manufacturing process.		
(4) At 100% of full load.		
These are average values based on tests with sinusoidal power supply, subject to the tolerances stipulated in NEMA MG-1.		
Rev.	Changes Summary	
Performed by	Performed	
Checked by	Checked	
Date	Date	
14/04/2022		
Page	Revision	
1 / 13		

TORQUE AND CURRENT VS SPEED CURVE

Three Phase Induction Motor - Squirrel Cage



Customer :

Product line : Premium Efficiency Three-Phase Product code : 13373691
 Catalog # : 002180T3E56CFL-S

TORQUE AND CURRENT VS SPEED CURVE

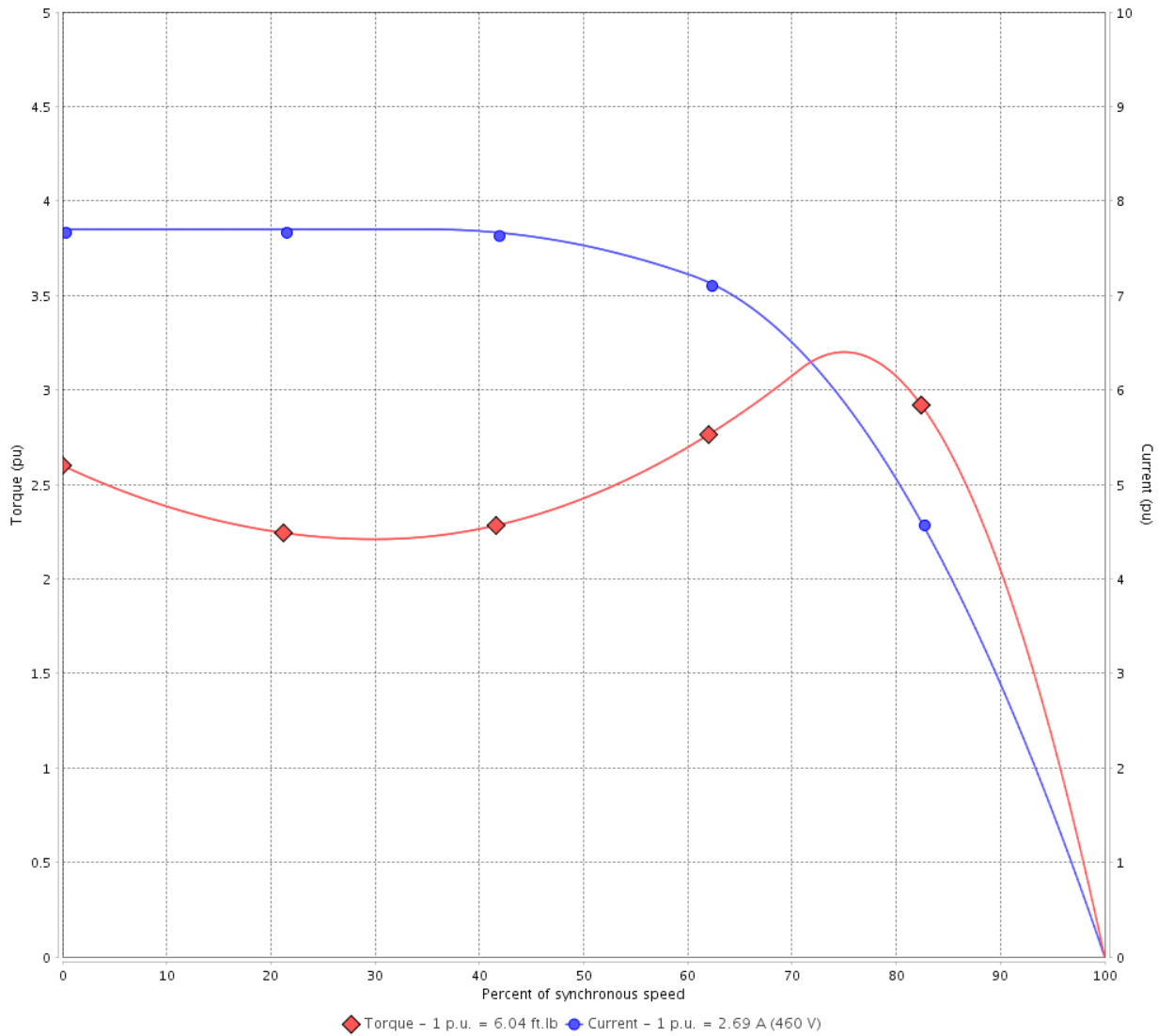

Performance : 230/460 V 60 Hz 4P

Rated current	: 5.38/2.69 A	Moment of inertia (J)	: 0.1168 sq.ft.lb
LRC	: 7.7	Duty cycle	: Cont.(S1)
Rated torque	: 6.04 ft.lb	Insulation class	: F
Locked rotor torque	: 260 %	Service factor	:
Breakdown torque	: 320 %	Temperature rise	: 80 K
Rated speed	: 1740 rpm	Design	: A

Locked rotor time : 30s (cold) 17s (hot)

Rev.	Changes Summary	Performed	Checked	Date
Performed by		Page		Revision
Checked by		2 / 13		
Date	14/04/2022			

TORQUE AND CURRENT VS SPEED CURVE



Three Phase Induction Motor - Squirrel Cage

Customer : _____

Product line : Premium Efficiency Three-Phase

Product code :

13373691

Catalog # :

00218OT3E56CFL-S

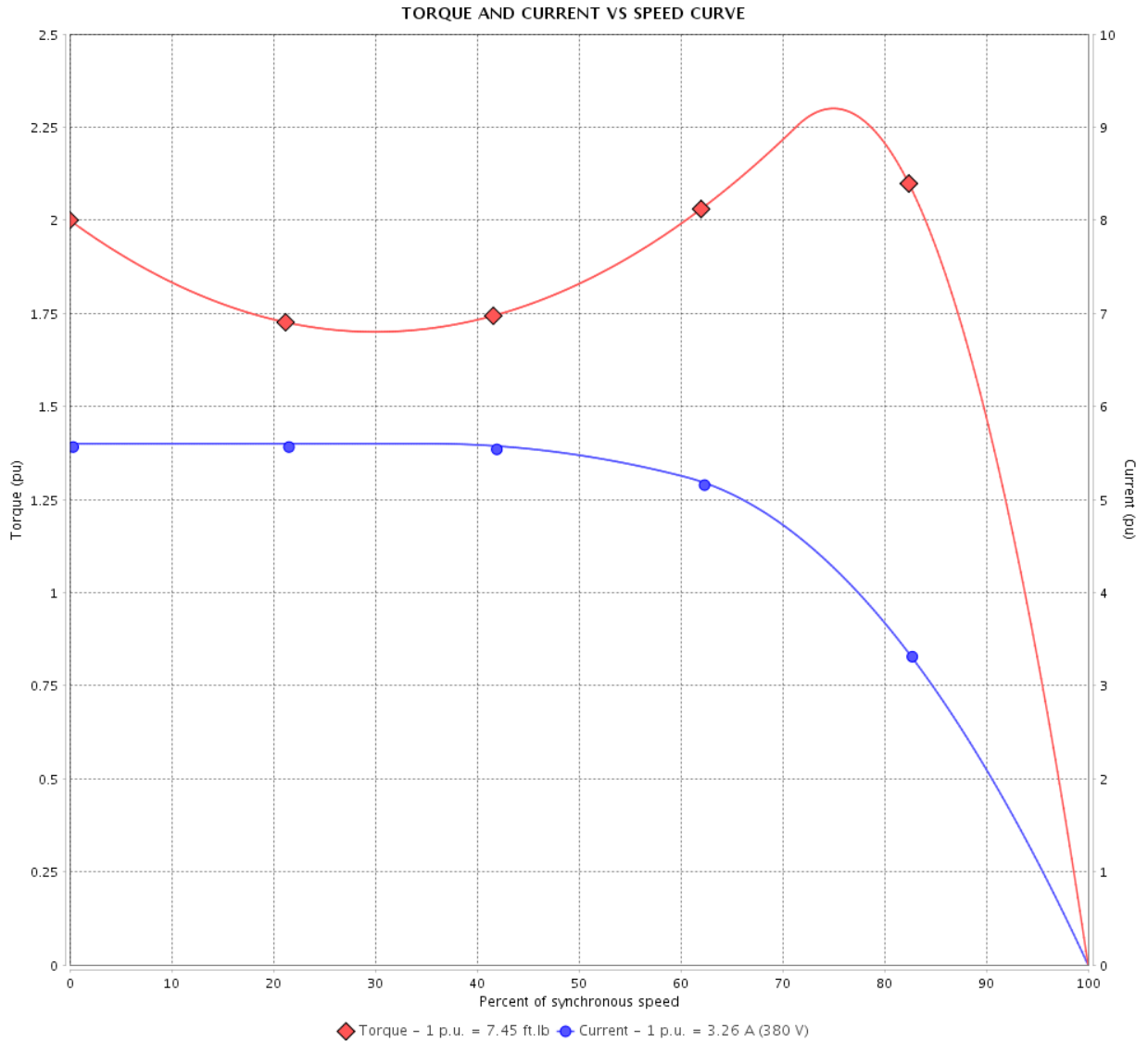

Performance : 190/380 V 50 Hz 4P

Rated current : 6.52/3.26 A
 LRC : 5.6
 Rated torque : 7.45 ft.lb
 Locked rotor torque : 200 %
 Breakdown torque : 229 %
 Rated speed : 1410 rpm

Moment of inertia (J) : 0.1168 sq.ft.lb
 Duty cycle : Cont.(S1)
 Insulation class : F
 Service factor : 1.00
 Temperature rise : 105 K
 Design : A

Locked rotor time : 28s (cold) 16s (hot)

Rev.	Changes Summary	Performed	Checked	Date
Performed by			Page	Revision
Checked by				
Date	14/04/2022			

TORQUE AND CURRENT VS SPEED CURVE

Three Phase Induction Motor - Squirrel Cage



Customer :

Product line : Premium Efficiency Three-Phase Product code : 13373691
 Catalog # : 00218OT3E56CFL-S

TORQUE AND CURRENT VS SPEED CURVE

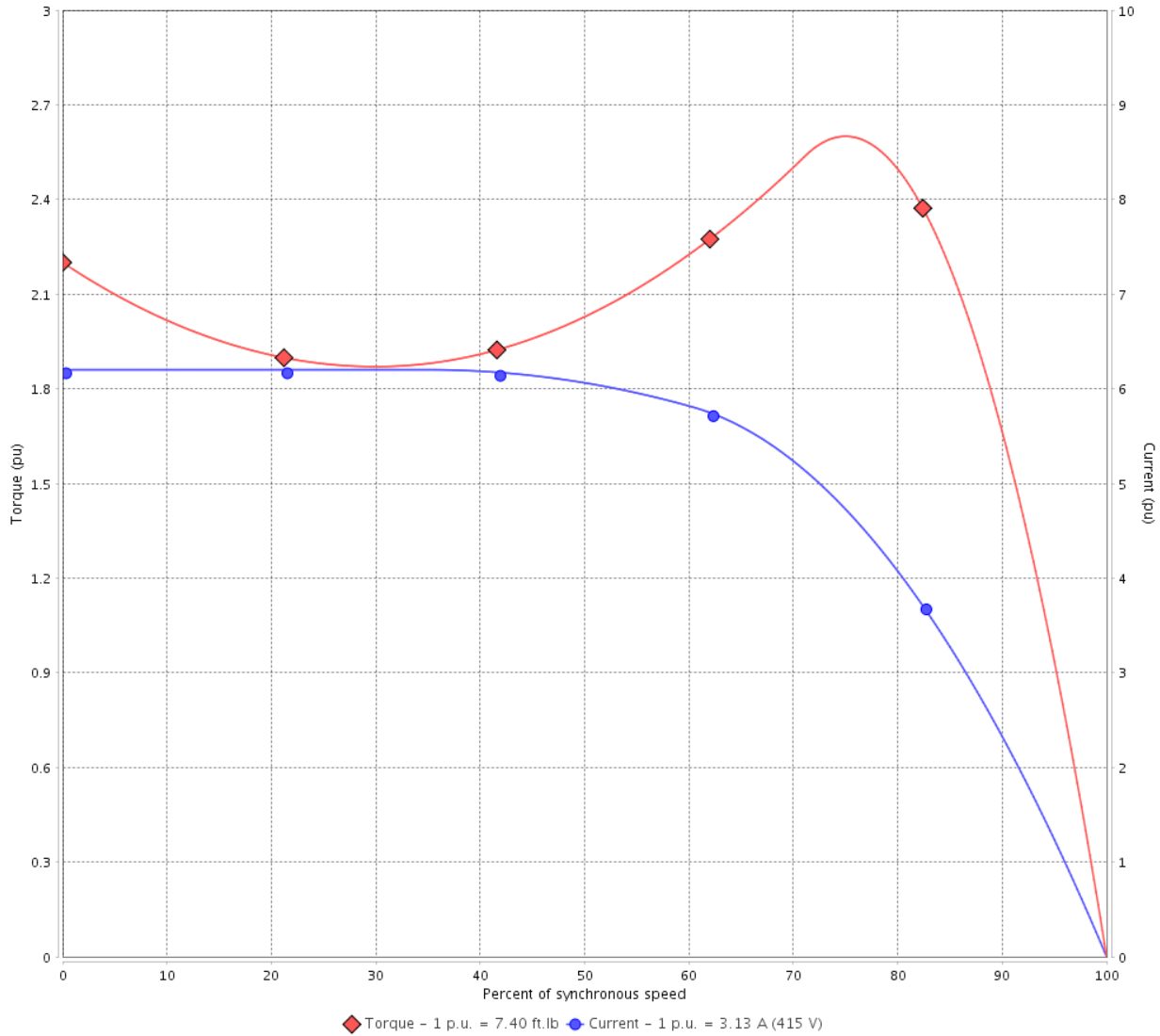

Performance : 220/415 V 50 Hz 4P

Rated current	: 5.90/3.13 A	Moment of inertia (J)	: 0.1168 sq.ft.lb
LRC	: 6.2	Duty cycle	: Cont.(S1)
Rated torque	: 7.40 ft.lb	Insulation class	: F
Locked rotor torque	: 220 %	Service factor	: 1.00
Breakdown torque	: 260 %	Temperature rise	: 80 K
Rated speed	: 1420 rpm	Design	: A

Locked rotor time : 27s (cold) 15s (hot)

Rev.	Changes Summary	Performed	Checked	Date
Performed by			Page 4 / 13	Revision
Checked by				
Date	14/04/2022			

LOAD PERFORMANCE CURVE

Three Phase Induction Motor - Squirrel Cage



Customer :

Product line : Premium Efficiency Three-Phase

Product code :

13373691

Catalog # :

002180T3E56CFL-S

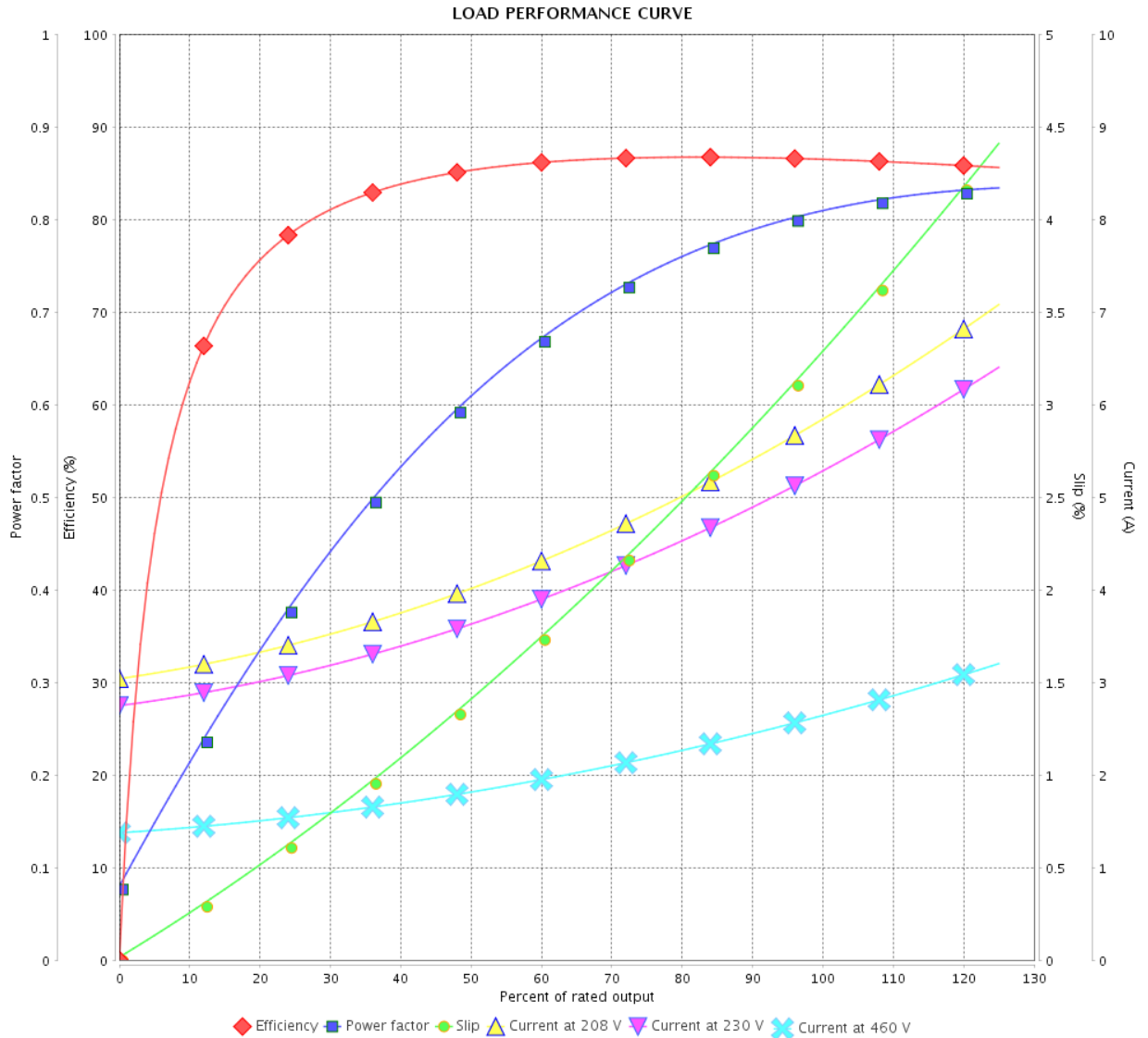

Performance : 230/460 V 60 Hz 4P

Rated current : 5.38/2.69 A
 LRC : 7.7
 Rated torque : 6.04 ft.lb
 Locked rotor torque : 260 %
 Breakdown torque : 320 %
 Rated speed : 1740 rpm

Moment of inertia (J) : 0.1168 sq.ft.lb
 Duty cycle : Cont.(S1)
 Insulation class : F
 Service factor :
 Temperature rise : 80 K
 Design : A

Rev.	Changes Summary	Performed	Checked	Date
Performed by			Page	Revision
Checked by				
Date				

LOAD PERFORMANCE CURVE

Three Phase Induction Motor - Squirrel Cage



Customer :

Product line : Premium Efficiency Three-Phase Product code : 13373691
 Catalog # : 002180T3E56CFL-S

LOAD PERFORMANCE CURVE

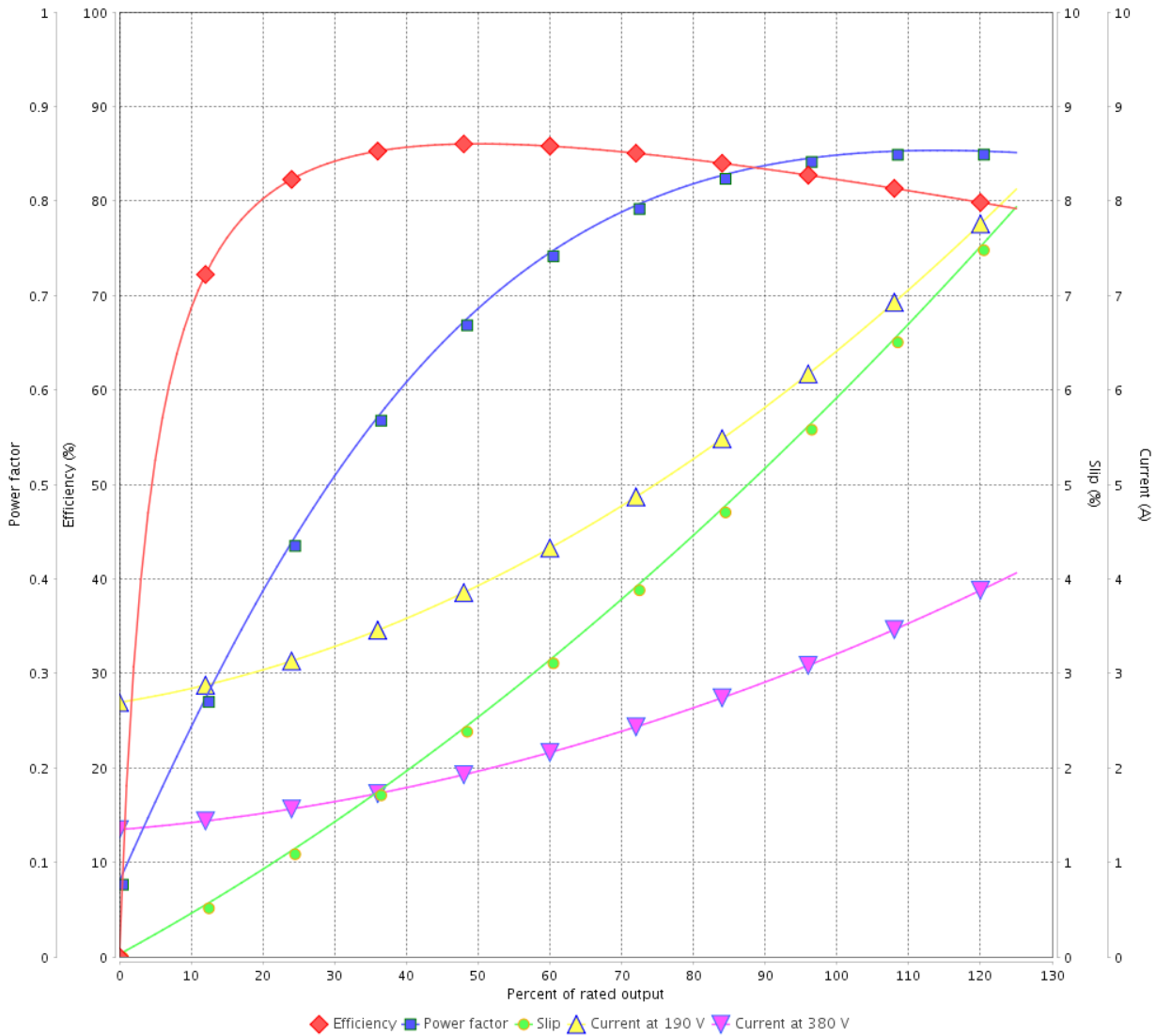

Performance : 190/380 V 50 Hz 4P

Rated current	: 6.52/3.26 A	Moment of inertia (J)	: 0.1168 sq.ft.lb
LRC	: 5.6	Duty cycle	: Cont.(S1)
Rated torque	: 7.45 ft.lb	Insulation class	: F
Locked rotor torque	: 200 %	Service factor	: 1.00
Breakdown torque	: 229 %	Temperature rise	: 105 K
Rated speed	: 1410 rpm	Design	: A

Rev.	Changes Summary	Performed	Checked	Date
Performed by			Page	Revision
Checked by			6 / 13	
Date	14/04/2022			

LOAD PERFORMANCE CURVE

Three Phase Induction Motor - Squirrel Cage



Customer : _____

Product line : Premium Efficiency Three-Phase

Product code :

13373691

Catalog # :

00218OT3E56CFL-S

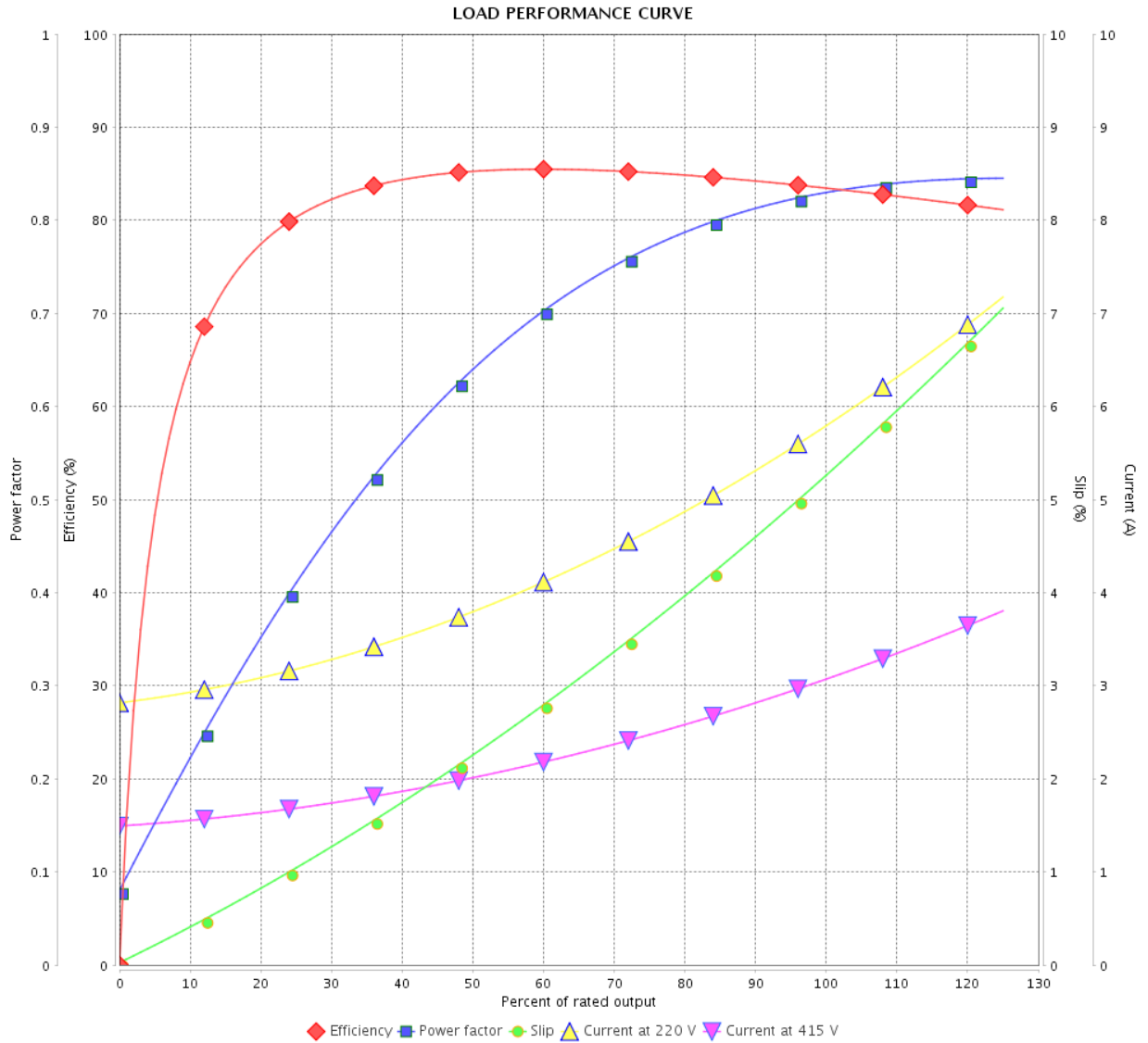

Performance : 220/415 V 50 Hz 4P

Rated current : 5.90/3.13 A
 LRC : 6.2
 Rated torque : 7.40 ft.lb
 Locked rotor torque : 220 %
 Breakdown torque : 260 %
 Rated speed : 1420 rpm

Moment of inertia (J) : 0.1168 sq.ft.lb
 Duty cycle : Cont.(S1)
 Insulation class : F
 Service factor : 1.00
 Temperature rise : 80 K
 Design : A

Rev.	Changes Summary	Performed	Checked	Date
Performed by		Page		Revision
Checked by		7 / 13		
Date		14/04/2022		

THERMAL LIMIT CURVE

Three Phase Induction Motor - Squirrel Cage



Customer : _____

Product line : Premium Efficiency Three-Phase

Product code :

13373691

Catalog # :

002180T3E56CFL-S

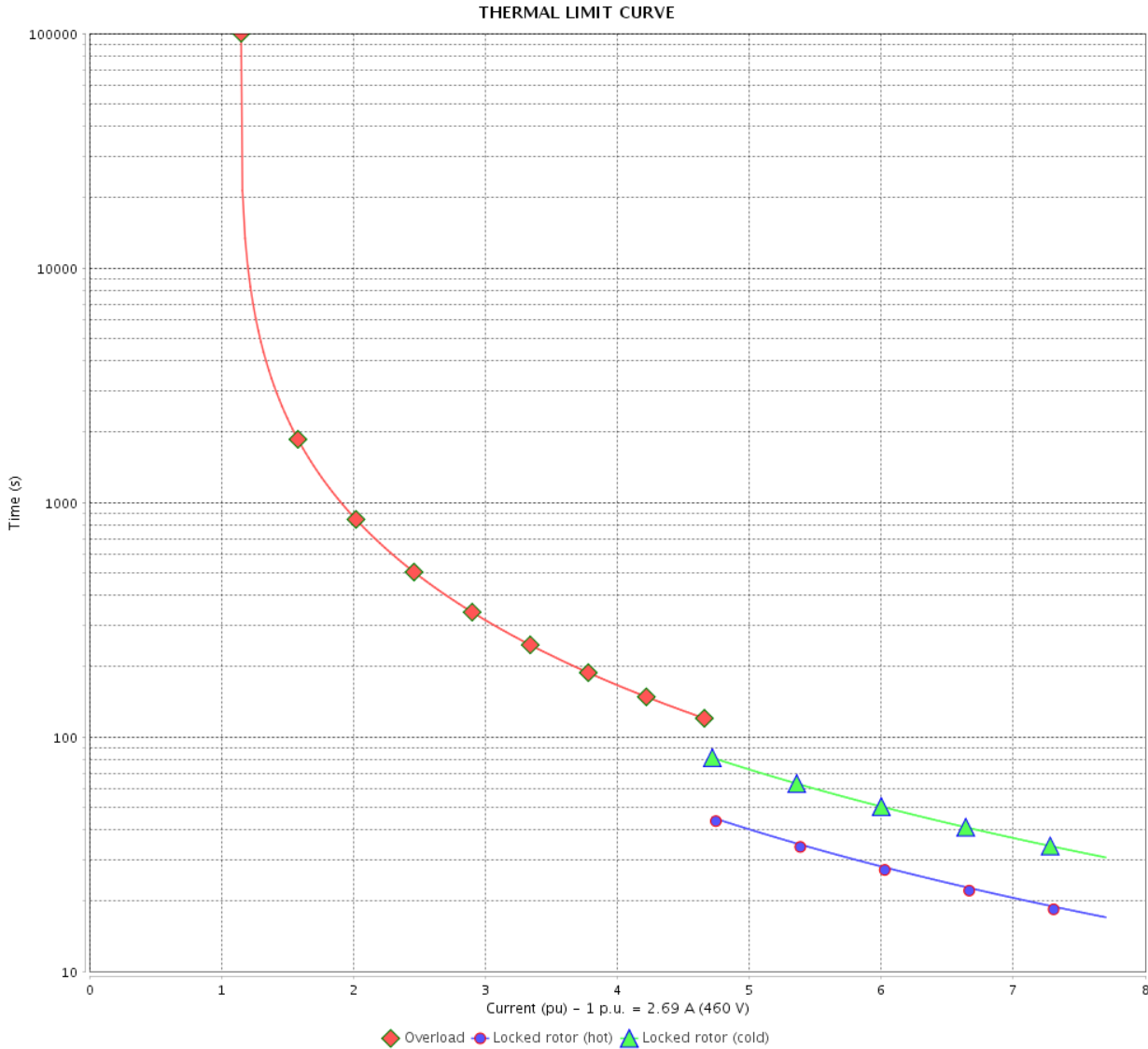

Performance : 230/460 V 60 Hz 4P

Rated current : 5.38/2.69 A
 LRC : 7.7
 Rated torque : 6.04 ft.lb
 Locked rotor torque : 260 %
 Breakdown torque : 320 %
 Rated speed : 1740 rpm

Moment of inertia (J) : 0.1168 sq.ft.lb
 Duty cycle : Cont.(S1)
 Insulation class : F
 Service factor :
 Temperature rise : 80 K
 Design : A

Heating constant

Cooling constant

Rev.	Changes Summary	Performed	Checked	Date
Performed by		Page		Revision
Checked by		8 / 13		
Date		14/04/2022		

THERMAL LIMIT CURVE

Three Phase Induction Motor - Squirrel Cage



Customer : _____

Product line : Premium Efficiency Three-Phase Product code : 13373691
 Catalog # : 00218OT3E56CFL-S

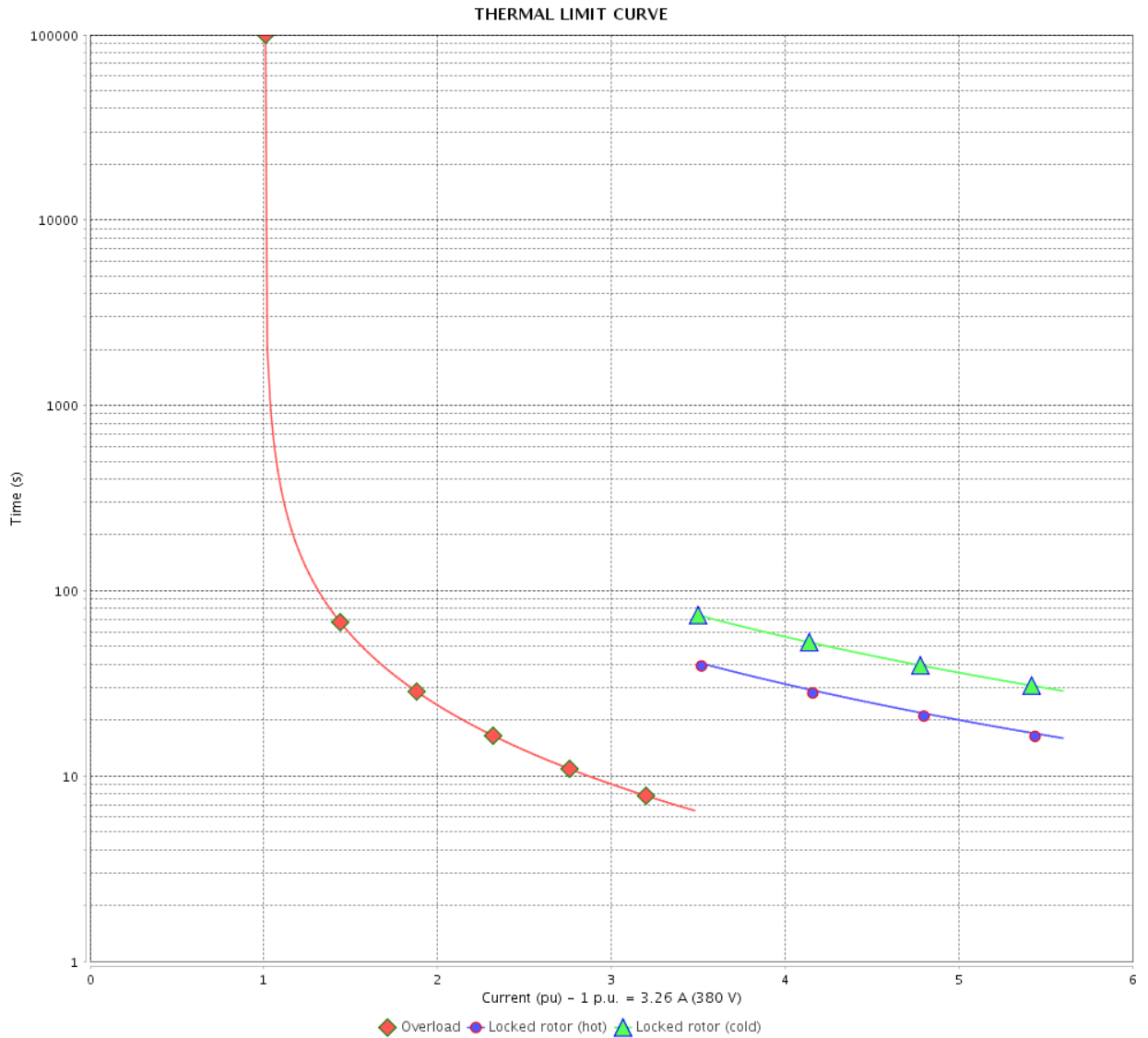

Performance : 190/380 V 50 Hz 4P

Rated current : 6.52/3.26 A
 LRC : 5.6
 Rated torque : 7.45 ft.lb
 Locked rotor torque : 200 %
 Breakdown torque : 229 %
 Rated speed : 1410 rpm

Moment of inertia (J) : 0.1168 sq.ft.lb
 Duty cycle : Cont.(S1)
 Insulation class : F
 Service factor : 1.00
 Temperature rise : 105 K
 Design : A

Heating constant
 Cooling constant

Rev.	Changes Summary	Performed	Checked	Date
Performed by	14/04/2022	Page		Revision
Checked by		9 / 13		
Date				

THERMAL LIMIT CURVE

Three Phase Induction Motor - Squirrel Cage



Customer : _____

Product line : Premium Efficiency Three-Phase Product code : 13373691
 Catalog # : 00218OT3E56CFL-S

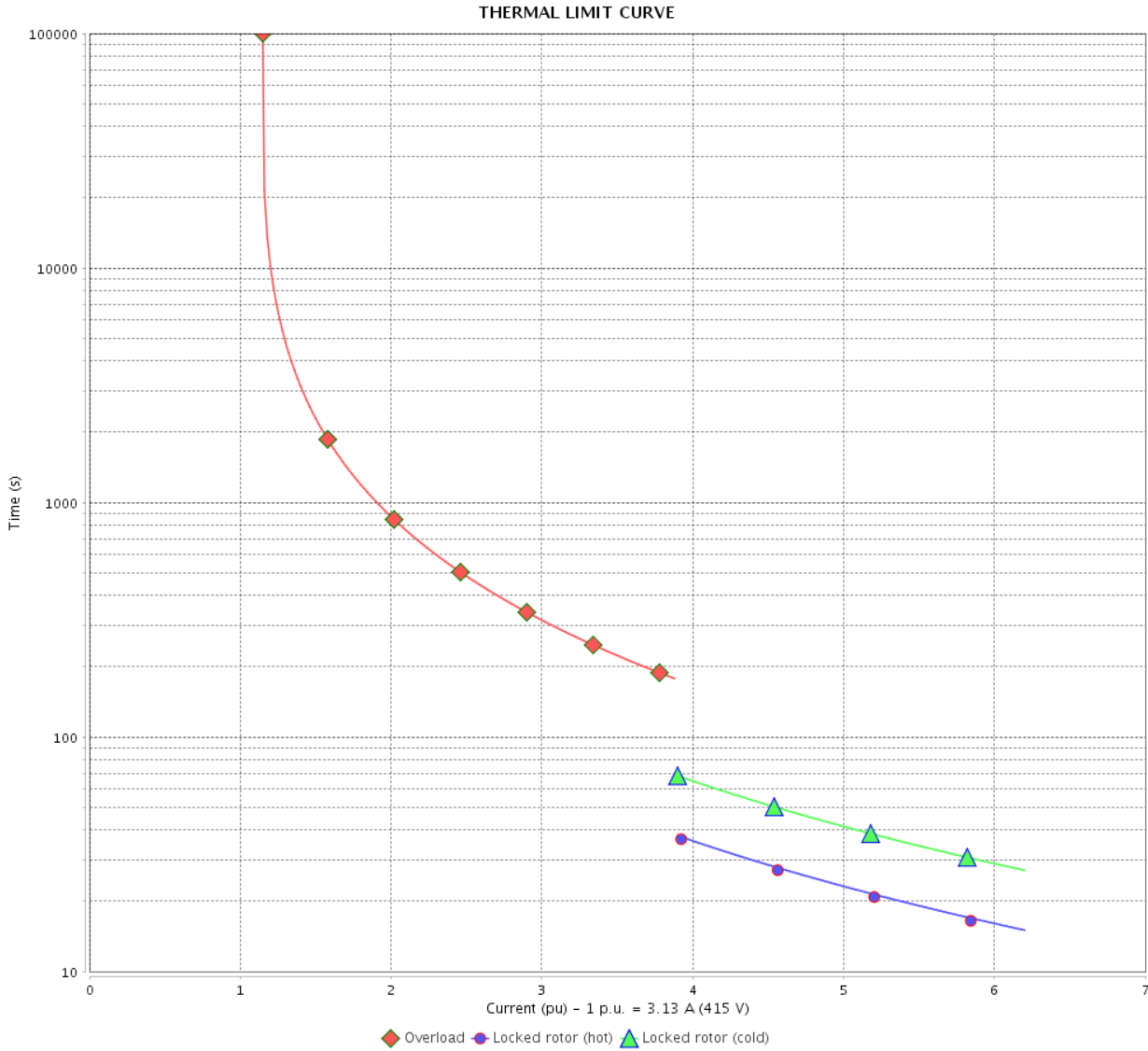

Performance : 220/415 V 50 Hz 4P

Rated current	: 5.90/3.13 A	Moment of inertia (J)	: 0.1168 sq.ft.lb
LRC	: 6.2	Duty cycle	: Cont.(S1)
Rated torque	: 7.40 ft.lb	Insulation class	: F
Locked rotor torque	: 220 %	Service factor	: 1.00
Breakdown torque	: 260 %	Temperature rise	: 80 K
Rated speed	: 1420 rpm	Design	: A

Heating constant

Cooling constant

Rev.	Changes Summary	Performed	Checked	Date
Performed by			Page 10 / 13	Revision
Checked by				
Date	14/04/2022			

VFD OPERATION CURVE

Three Phase Induction Motor - Squirrel Cage



Customer : _____

Product line : Premium Efficiency Three-Phase Product code : 13373691
 Catalog # : 00218OT3E56CFL-S

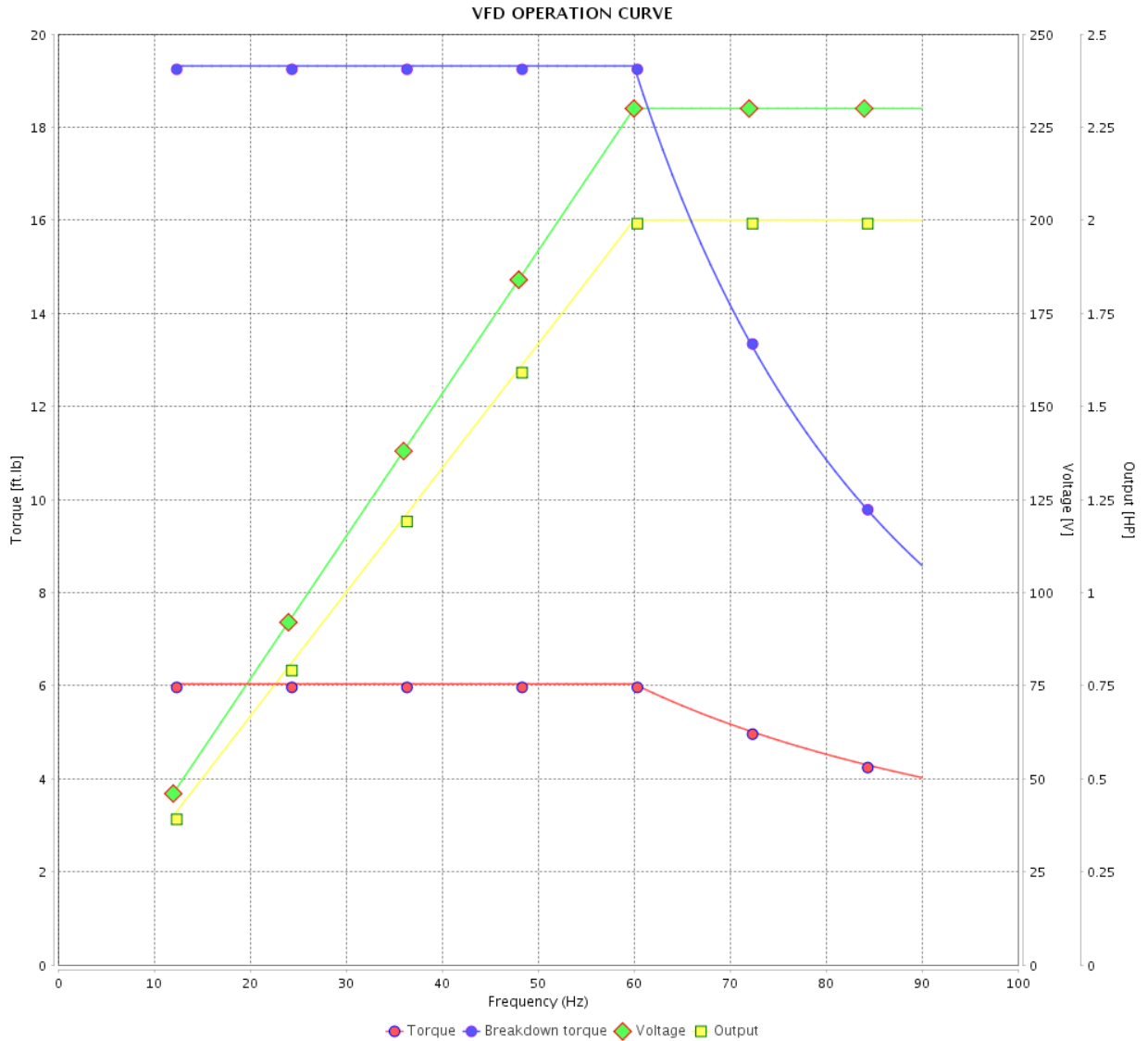

Performance : 230/460 V 60 Hz 4P

Rated current : 5.38/2.69 A
 LRC : 7.7
 Rated torque : 6.04 ft.lb
 Locked rotor torque : 260 %
 Breakdown torque : 320 %
 Rated speed : 1740 rpm

Moment of inertia (J) : 0.1168 sq.ft.lb
 Duty cycle : Cont.(S1)
 Insulation class : F
 Service factor :
 Temperature rise : 80 K
 Design : A

Rev.	Changes Summary	Performed	Checked	Date
Performed by		Page		Revision
Checked by		11 / 13		
Date		14/04/2022		

VFD OPERATION CURVE

Three Phase Induction Motor - Squirrel Cage



Customer :

Product line : Premium Efficiency Three-Phase Product code : 13373691
 Catalog # : 002180T3E56CFL-S

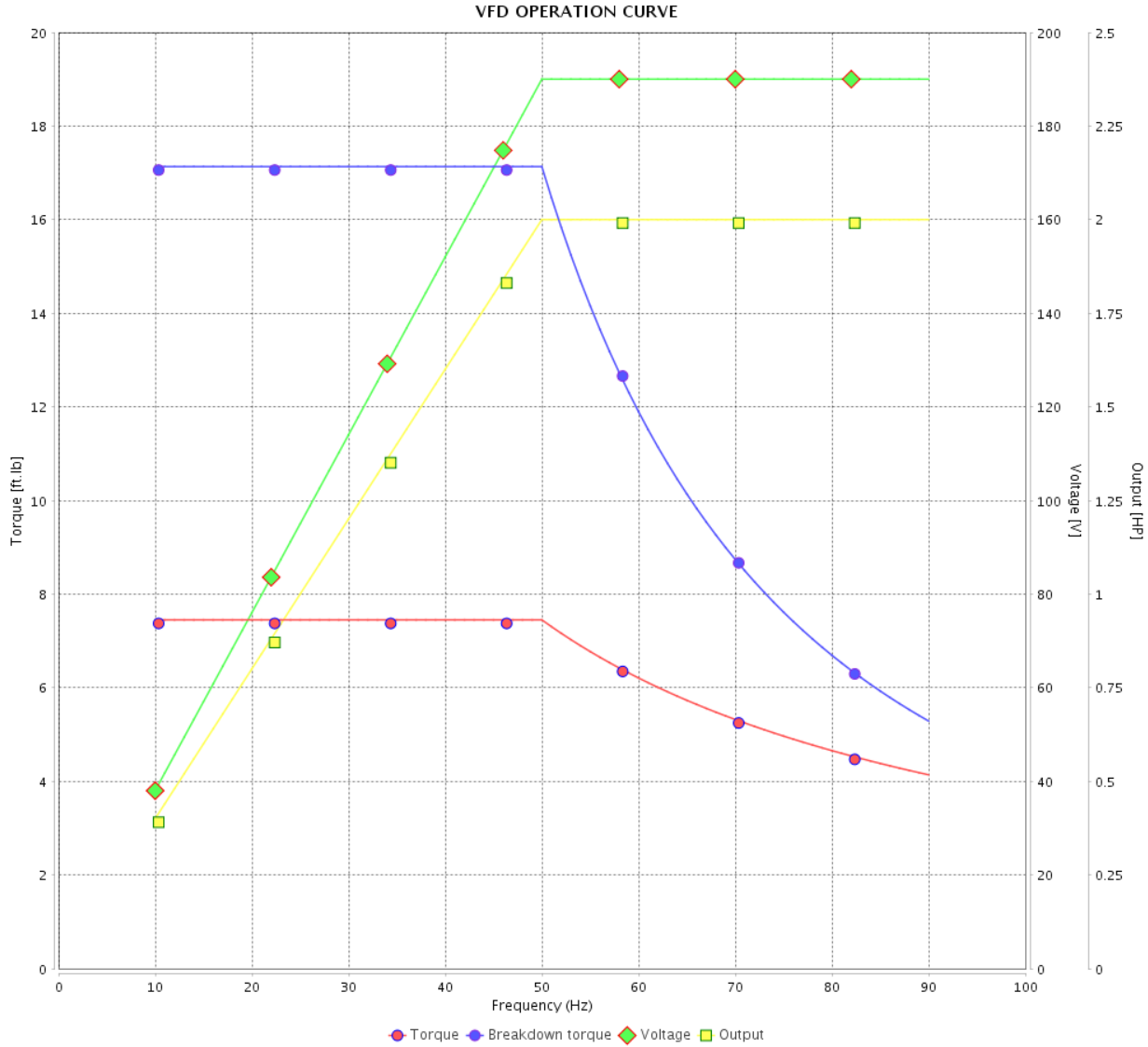

Performance : 190/380 V 50 Hz 4P

Rated current	: 6.52/3.26 A	Moment of inertia (J)	: 0.1168 sq.ft.lb
LRC	: 5.6	Duty cycle	: Cont.(S1)
Rated torque	: 7.45 ft.lb	Insulation class	: F
Locked rotor torque	: 200 %	Service factor	: 1.00
Breakdown torque	: 229 %	Temperature rise	: 105 K
Rated speed	: 1410 rpm	Design	: A

Rev.	Changes Summary	Performed	Checked	Date
Performed by			Page 12 / 13	Revision
Checked by				
Date	14/04/2022			

VFD OPERATION CURVE

Three Phase Induction Motor - Squirrel Cage



Customer :

Product line : Premium Efficiency Three-Phase Product code : 13373691
 Catalog # : 00218OT3E56CFL-S

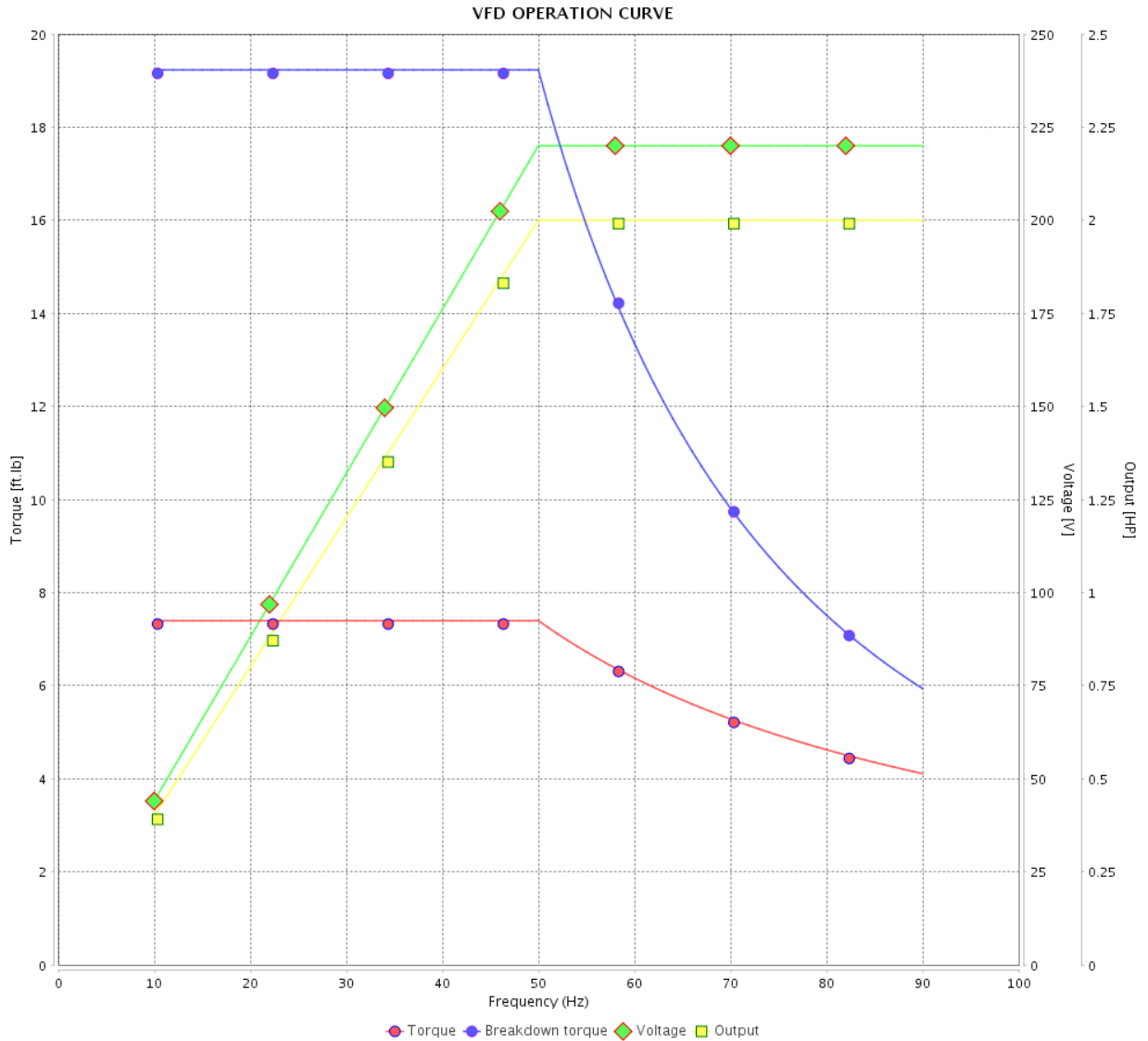

Performance : 220/415 V 50 Hz 4P

Rated current : 5.90/3.13 A
 LRC : 6.2
 Rated torque : 7.40 ft.lb
 Locked rotor torque : 220 %
 Breakdown torque : 260 %
 Rated speed : 1420 rpm

Moment of inertia (J) : 0.1168 sq.ft.lb
 Duty cycle : Cont.(S1)
 Insulation class : F
 Service factor : 1.00
 Temperature rise : 80 K
 Design : A

Rev.	Changes Summary	Performed	Checked	Date
Performed by		Page		Revision
Checked by		13 / 13		
Date		14/04/2022		

1 2 3 4 5 6

A

B

C

D

E

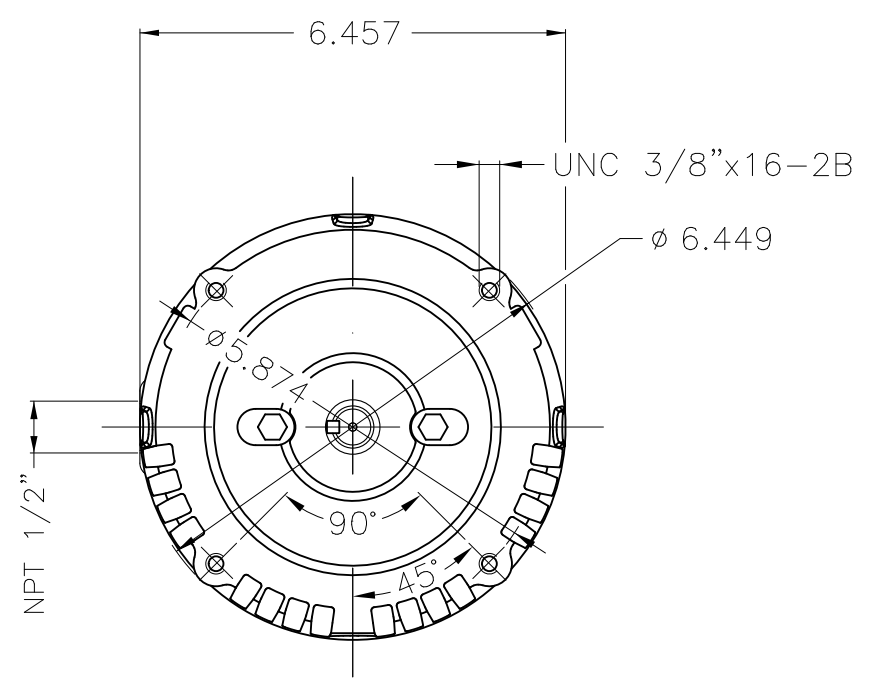

Grounding

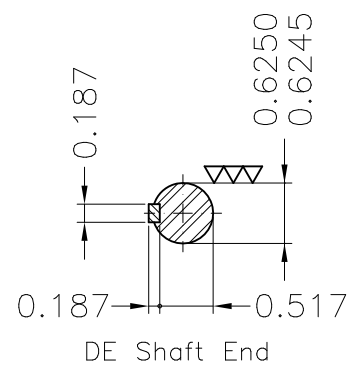
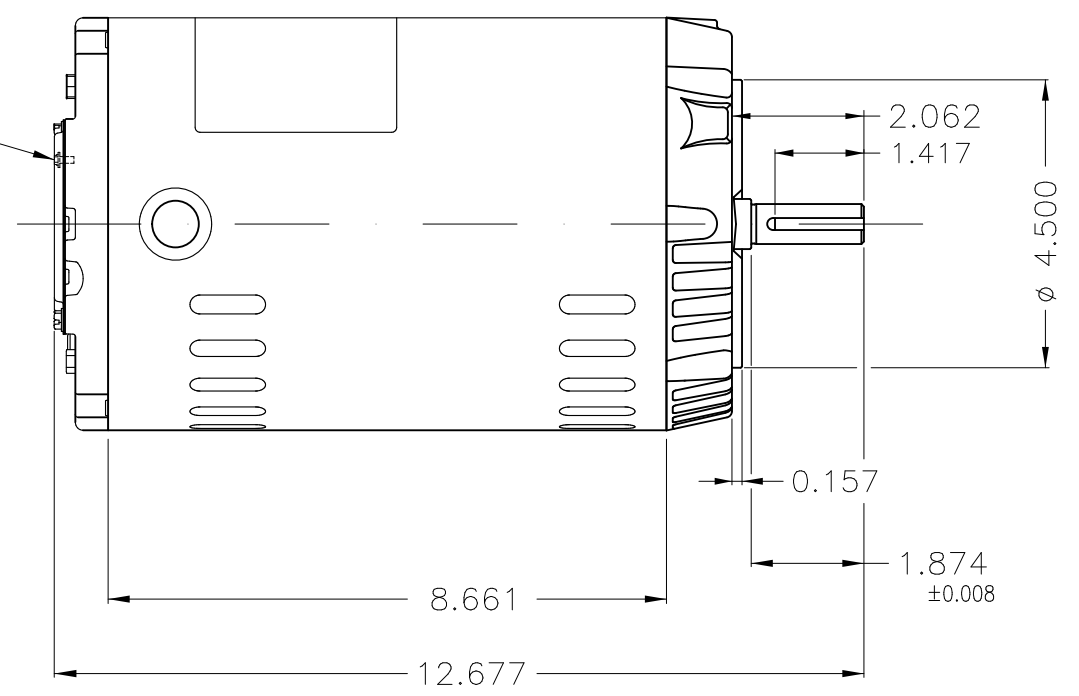

Dimensions in inches

Without coating										
Mounting F-1/B14R(D)										
ECM	LOC	SUMMARY OF MODIFICATIONS				EXECUTED	CHECKED	RELEASED	DATE	VER
EXECUTED	PIRWUSER	THREE PH. MOTOR ROLLED STEEL PREM. EFF.					PREVIEW			
CHECKED		FRAME 56C IP21 ODP					WDD			
RELEASED										
REL DT.		WMO	Jaragua do Sul	Product Engineering	SHEET	1 / 1				

2 HP 04 Poles 60 Hz

A

XME A3



NEMA
Premium



3PT9



Energy Verified

MADE IN MEXICO

MAT: 13373691

W01.T00IC0X0X

MODEL 002180T3E56CFL-S

10MAR2022 B/N:

PH 3	Hz 60	HP 2.0
FR 56C		KW 1.5
DUTY CONT.		V 230/460
ALT 1000 m.a.s.l.		A 5.38/2.69
INS CL F AT 80K		SFA 6.19/3.09
AMB 40°C	DES A	SF 1.15
ENCL ODP	CODE K	PF 0.81
USABLE @ 208V 5.95A		RPM 1740
SF1.00		NEMA NOM. EFF 86.5%

ALTERNATE RATING: 2.0HP 50Hz 190-220/380-415V SF1.00
6.52-5.79/3.26-3.07A 1410RPM EFF 82.2% (IE1) IEC 60034-1

Inverter duty motor For 80Hz use on VPWM 1000:1 VT, 5:1 CT

DE 6204-ZZ	ODE 6202-ZZ	MOBIL POLYREX EM
-------------------	--------------------	-------------------------



T1-BLU T2-WHT
 T3-ORG T4-YEL
 T5-BLK T6-GRY
 T7-PNK T8-RED
 T9-BRK RED

INTERCHANGE ANY TWO LINE WIRES TO REVERSE THE ROTATION



WARNING: Motor must be grounded in accordance with local and national electrical codes to prevent serious electrical shocks. Disconnect power source before servicing unit.

AVERTISSEMENT: Le moteur doit être mis à la terre conformément aux codes électriques locaux et nationaux afin d'éviter tout choc électrique grave. Déconnectez l'alimentation avant l'entretien de la machine.

