

DATA SHEET

Three Phase Induction Motor - Squirrel Cage



Customer :								
Product line	: NEMA Premium Efficiency Three-Phase	Product code :	11431460					
		Catalog # :	00218ST3QIE145T-W22					
Frame	: 143/5T	Cooling method	: IC411 - TEFC					
Insulation class	: F	Mounting	: F-1					
Duty cycle	: Cont.(S1)	Rotation ¹	: Both (CW and CCW)					
Ambient temperature	: -20°C to +40°C	Starting method	: Direct On Line					
Altitude	: 1000 m.a.s.l.	Approx. weight ²	: 57.0 lb					
Protection degree	: IP55	Moment of inertia (J)	: 0.1561 sq.ft.lb					
Design	: B							
Output [HP]	2	1.5	1.5	1.5	2	2	2	
Poles	4	4	4	4	4	4	4	
Frequency [Hz]	60	50	50	50	50	50	50	
Rated voltage [V]	460	380	400	415	380	400	415	
Rated current [A]	2.76	2.57	2.57	2.56	3.33	3.22	3.14	
L. R. Amperes [A]	22.9	21.1	22.4	21.5	20.0	21.3	22.9	
LRC [A]	8.3x(Code L)	8.2x(Code L)	8.7x(Code M)	8.4x(Code M)	6.0x(Code H)	6.6x(Code J)	7.3x(Code K)	
No load current [A]	1.63	1.61	1.80	1.97	1.61	1.80	1.97	
Rated speed [RPM]	1750	1460	1465	1465	1435	1440	1450	
Slip [%]	2.78	2.67	2.33	2.33	4.33	4.00	3.33	
Rated torque [ft.lb]	6.00	5.40	5.38	5.38	7.32	7.29	7.24	
Locked rotor torque [%]	270	290	320	350	220	229	250	
Breakdown torque [%]	320	330	380	409	240	260	290	
Service factor	1.25	1.25	1.25	1.25	1.25	1.25	1.25	
Temperature rise	80 K	80 K	80 K	80 K	80 K	80 K	80 K	
Locked rotor time	23s (cold) 13s (hot)	32s (cold) 18s (hot)	28s (cold) 16s (hot)	27s (cold) 15s (hot)	23s (cold) 13s (hot)	21s (cold) 12s (hot)	21s (cold) 12s (hot)	
Noise level ²	51.0 dB(A)	49.0 dB(A)	49.0 dB(A)	49.0 dB(A)	49.0 dB(A)	49.0 dB(A)	49.0 dB(A)	
Efficiency (%)	25%	85.2	83.5	80.9	80.3	86.7	83.7	83.8
	50%	85.5	84.0	82.0	81.4	85.5	84.0	84.0
	75%	86.5	84.2	83.5	83.1	84.0	84.0	84.0
	100%	86.5	84.5	84.5	84.1	82.5	84.0	84.0
Power Factor	25%	0.32	0.31	0.27	0.25	0.39	0.35	0.32
	50%	0.57	0.55	0.50	0.47	0.66	0.62	0.60
	75%	0.70	0.69	0.64	0.61	0.78	0.74	0.72
	100%	0.79	0.77	0.73	0.71	0.83	0.80	0.79
Bearing type	: 6205 C3	6204 C3	Foundation loads					
Sealing	: Inpro/Seal	Inpro/Seal	Max. traction	: 154 lb				
Lubrication interval	: 20000 h	20000 h	Max. compression	: 211 lb				
Lubricant amount	: 4 g	4 g						
Lubricant type	: Mobil Polyrex EM							
Notes								
This revision replaces and cancel the previous one, which must be eliminated. (1) Looking the motor from the shaft end. (2) Measured at 1m and with tolerance of +3dB(A). (3) Approximate weight subject to changes after manufacturing process. (4) At 100% of full load.				These are average values based on tests with sinusoidal power supply, subject to the tolerances stipulated in NEMA MG-1.				
Rev.	Changes Summary			Performed	Checked	Date		
Performed by								
Checked by					Page	Revision		
Date	14/04/2022				1 / 36			

TORQUE AND CURRENT VS SPEED CURVE

Three Phase Induction Motor - Squirrel Cage



Customer :

Product line : NEMA Premium Efficiency Three-Phase

Product code : 11431460

Catalog # : 00218ST3QIE145T-W22

TORQUE AND CURRENT VS SPEED CURVE

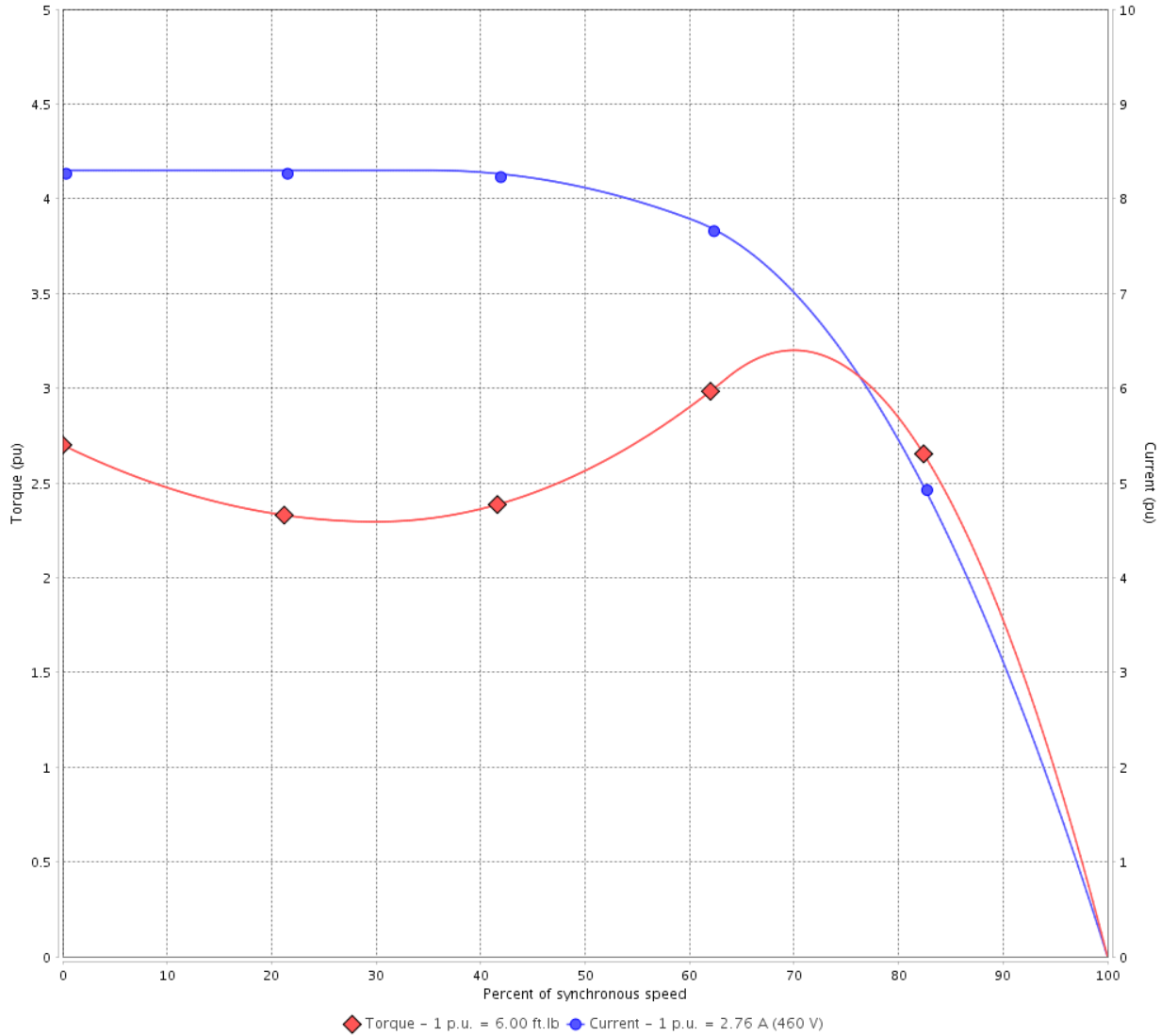

Performance : 460 V 60 Hz 4P

Rated current	: 2.76 A	Moment of inertia (J)	: 0.1561 sq.ft.lb
LRC	: 8.3	Duty cycle	: Cont.(S1)
Rated torque	: 6.00 ft.lb	Insulation class	: F
Locked rotor torque	: 270 %	Service factor	: 1.25
Breakdown torque	: 320 %	Temperature rise	: 80 K
Rated speed	: 1750 rpm	Design	: B

Locked rotor time : 23s (cold) 13s (hot)

Rev.	Changes Summary	Performed	Checked	Date
Performed by			Page 2 / 36	Revision
Checked by				
Date	14/04/2022			

TORQUE AND CURRENT VS SPEED CURVE



Three Phase Induction Motor - Squirrel Cage

Customer :

Product line : NEMA Premium Efficiency Three-Phase

Product code : 11431460

Catalog # : 00218ST3QIE145T-W22

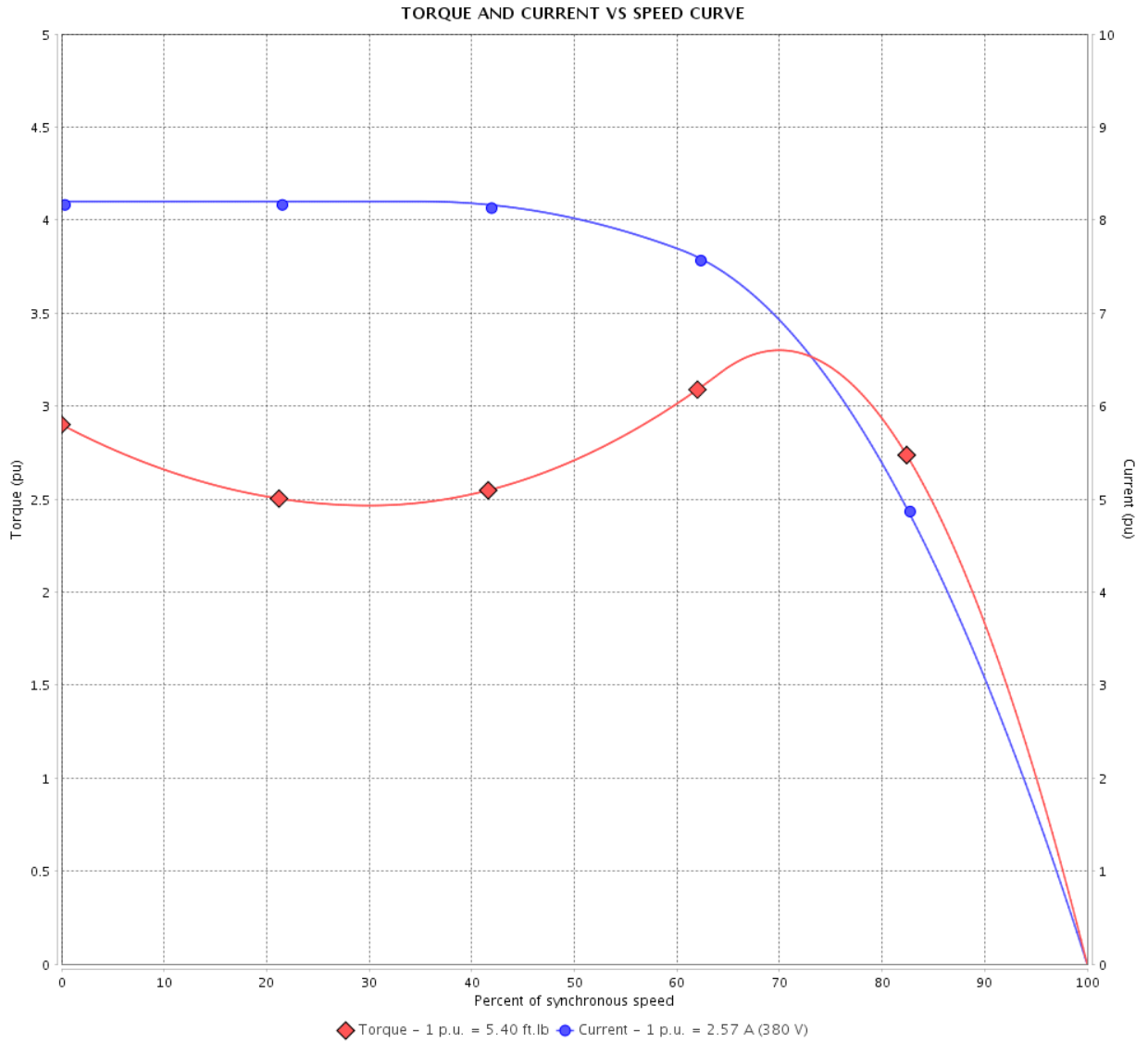

Performance : 380 V 50 Hz 4P IE3

Rated current	: 2.57 A	Moment of inertia (J)	: 0.1561 sq.ft.lb
LRC	: 8.2	Duty cycle	: Cont.(S1)
Rated torque	: 5.40 ft.lb	Insulation class	: F
Locked rotor torque	: 290 %	Service factor	: 1.25
Breakdown torque	: 330 %	Temperature rise	: 80 K
Rated speed	: 1460 rpm	Design	: B

Locked rotor time : 32s (cold) 18s (hot)

Rev.	Changes Summary	Performed	Checked	Date
Performed by			Page 3 / 36	Revision
Checked by				
Date	14/04/2022			

TORQUE AND CURRENT VS SPEED CURVE

Three Phase Induction Motor - Squirrel Cage



Customer :

Product line : NEMA Premium Efficiency Three-Phase

Product code : 11431460

Catalog # : 00218ST3QIE145T-W22

TORQUE AND CURRENT VS SPEED CURVE

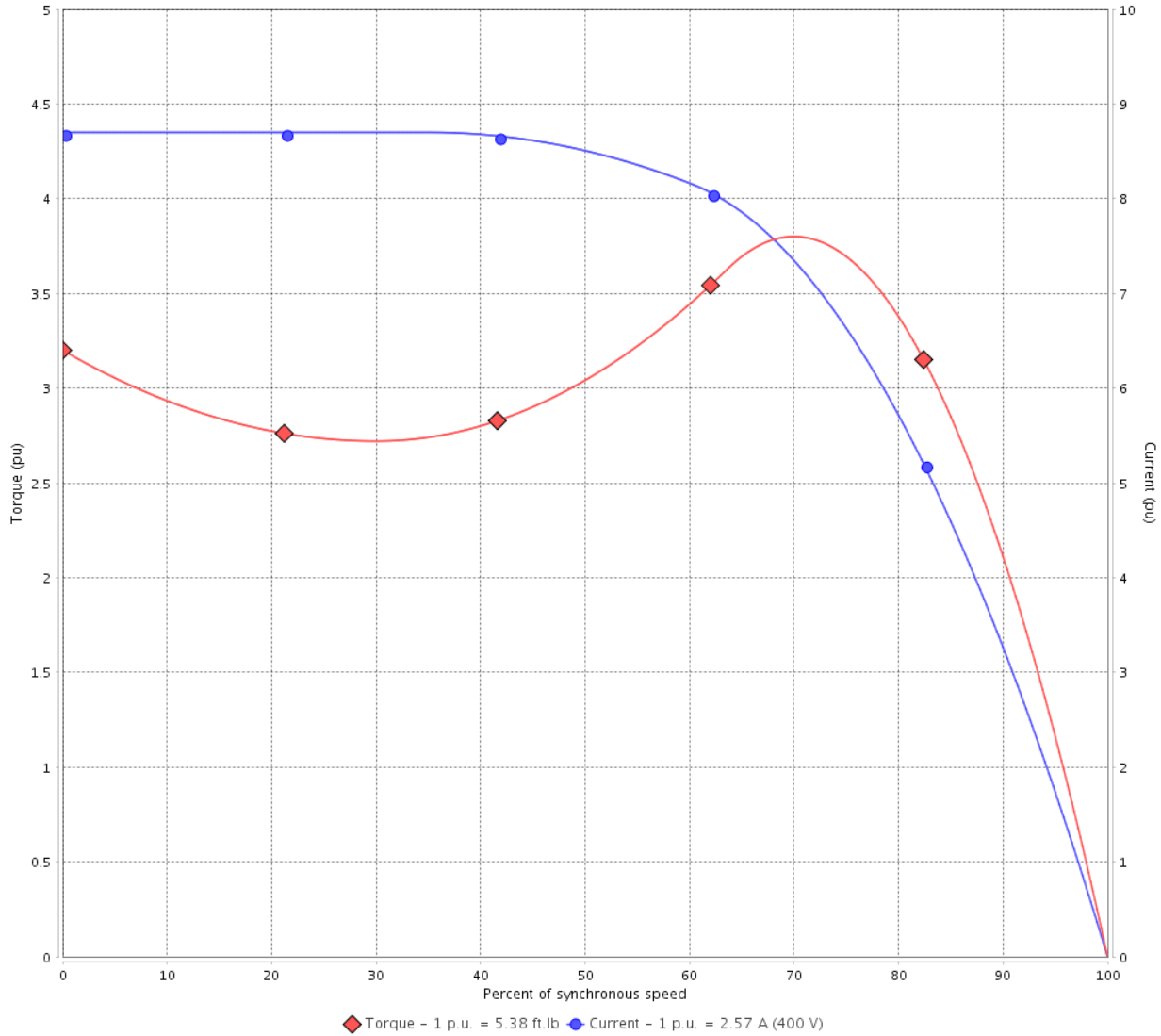

Performance : 400 V 50 Hz 4P IE3

Rated current	: 2.57 A	Moment of inertia (J)	: 0.1561 sq.ft.lb
LRC	: 8.7	Duty cycle	: Cont.(S1)
Rated torque	: 5.38 ft.lb	Insulation class	: F
Locked rotor torque	: 320 %	Service factor	: 1.25
Breakdown torque	: 380 %	Temperature rise	: 80 K
Rated speed	: 1465 rpm	Design	: B

Locked rotor time : 28s (cold) 16s (hot)

Rev.	Changes Summary	Performed	Checked	Date
Performed by			Page 4 / 36	Revision
Checked by				
Date	14/04/2022			

TORQUE AND CURRENT VS SPEED CURVE



Three Phase Induction Motor - Squirrel Cage

Customer :

Product line : NEMA Premium Efficiency Three-Phase

Product code : 11431460

Catalog # : 00218ST3QIE145T-W22

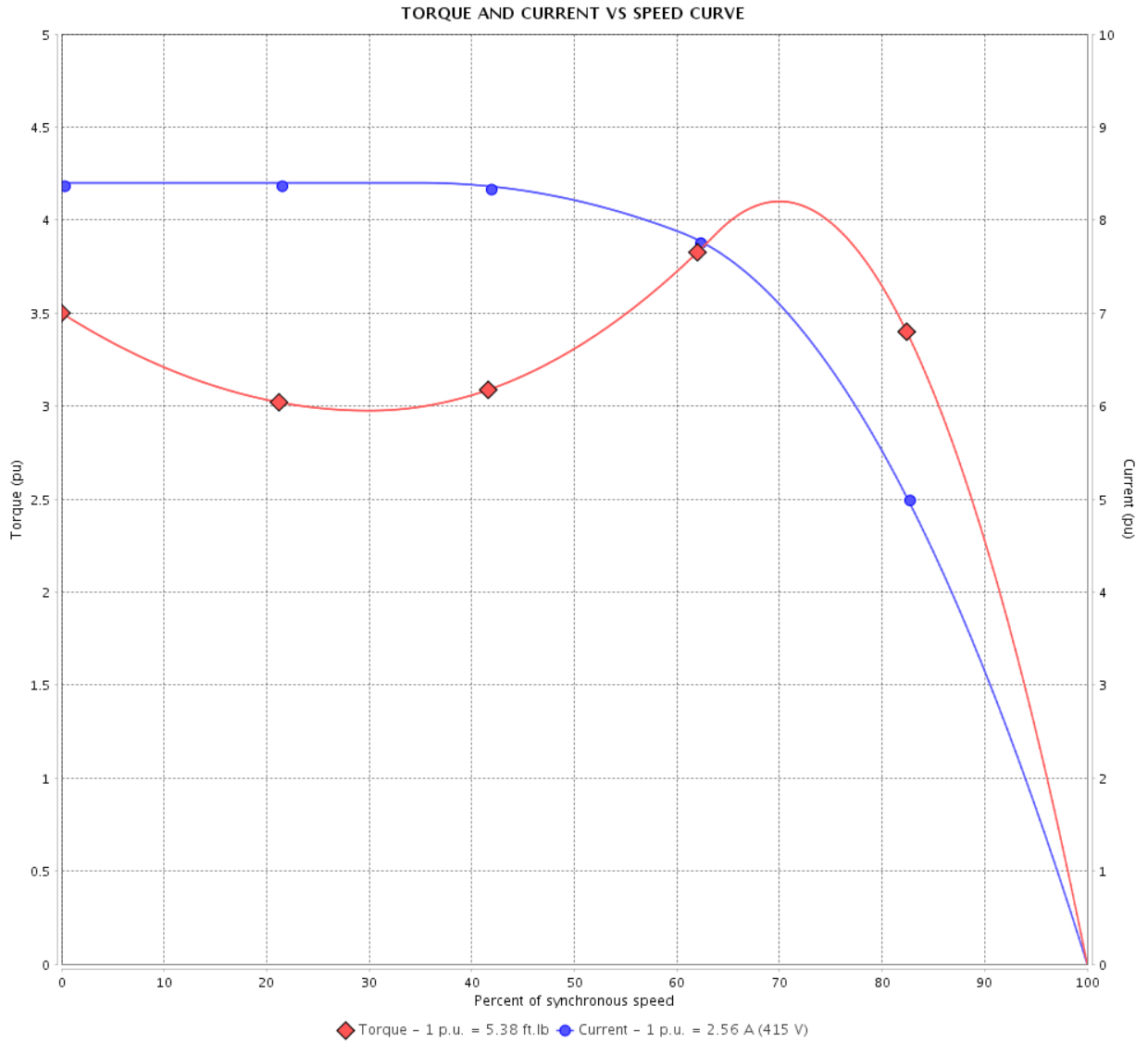

Performance : 415 V 50 Hz 4P IE3

Rated current	: 2.56 A	Moment of inertia (J)	: 0.1561 sq.ft.lb
LRC	: 8.4	Duty cycle	: Cont.(S1)
Rated torque	: 5.38 ft.lb	Insulation class	: F
Locked rotor torque	: 350 %	Service factor	: 1.25
Breakdown torque	: 409 %	Temperature rise	: 80 K
Rated speed	: 1465 rpm	Design	: B

Locked rotor time : 27s (cold) 15s (hot)

Rev.	Changes Summary	Performed	Checked	Date
Performed by			Page	Revision
Checked by			5 / 36	
Date	14/04/2022			

TORQUE AND CURRENT VS SPEED CURVE

Three Phase Induction Motor - Squirrel Cage



Customer :

Product line : NEMA Premium Efficiency Three-Phase

Product code : 11431460

Catalog # : 00218ST3QIE145T-W22

TORQUE AND CURRENT VS SPEED CURVE

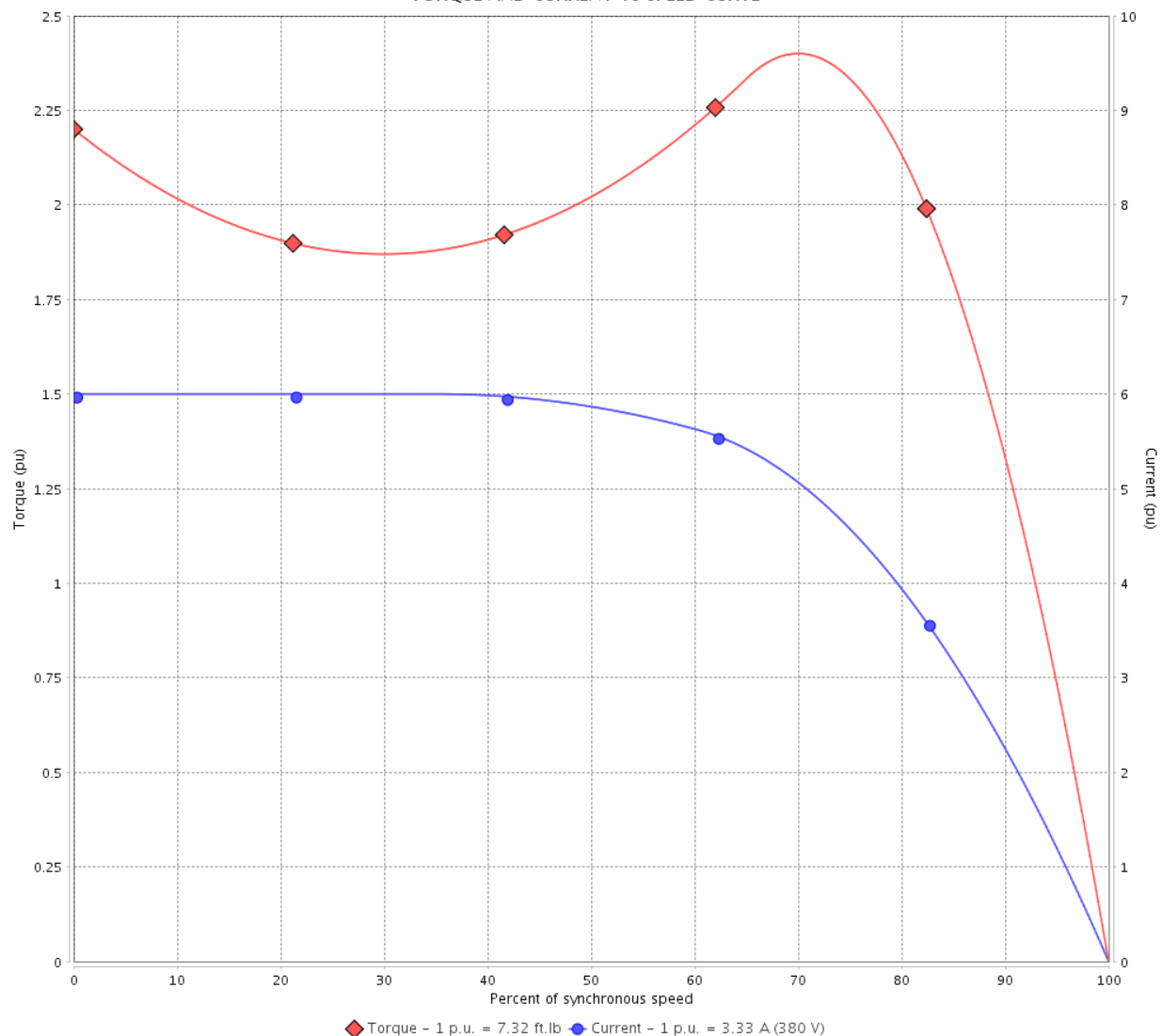

Performance : 380 V 50 Hz 4P IE1

Rated current	: 3.33 A	Moment of inertia (J)	: 0.1561 sq.ft.lb
LRC	: 6.0	Duty cycle	: Cont.(S1)
Rated torque	: 7.32 ft.lb	Insulation class	: F
Locked rotor torque	: 220 %	Service factor	: 1.25
Breakdown torque	: 240 %	Temperature rise	: 80 K
Rated speed	: 1435 rpm	Design	: B

Locked rotor time : 23s (cold) 13s (hot)

Rev.	Changes Summary	Performed	Checked	Date
Performed by			Page 6 / 36	Revision
Checked by				
Date	14/04/2022			

TORQUE AND CURRENT VS SPEED CURVE



Three Phase Induction Motor - Squirrel Cage

Customer :

Product line : NEMA Premium Efficiency Three-Phase

Product code : 11431460

Catalog # : 00218ST3QIE145T-W22

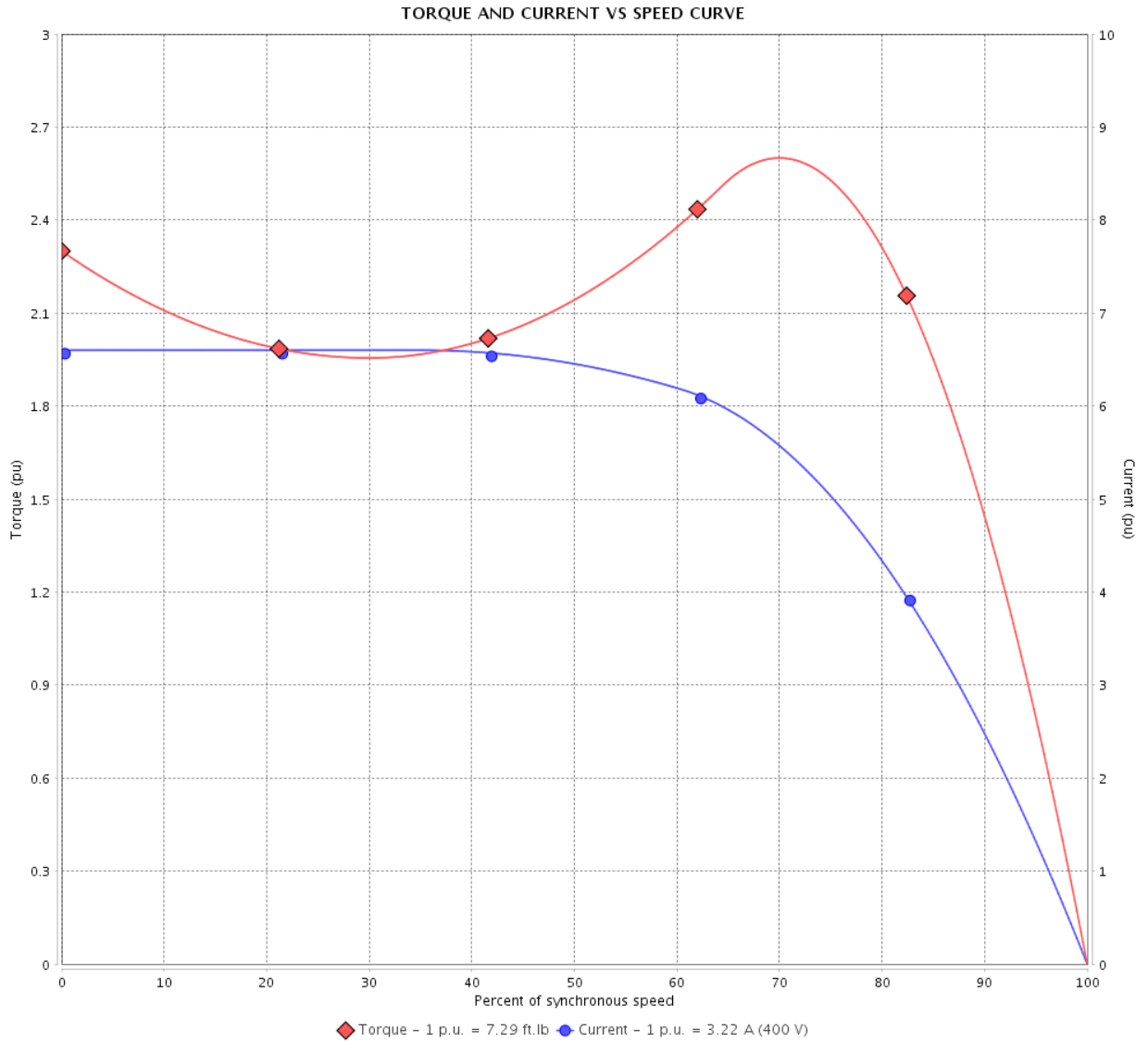

Performance : 400 V 50 Hz 4P IE2

Rated current : 3.22 A
 LRC : 6.6
 Rated torque : 7.29 ft.lb
 Locked rotor torque : 229 %
 Breakdown torque : 260 %
 Rated speed : 1440 rpm

Moment of inertia (J) : 0.1561 sq.ft.lb
 Duty cycle : Cont.(S1)
 Insulation class : F
 Service factor : 1.25
 Temperature rise : 80 K
 Design : B

Locked rotor time : 21s (cold) 12s (hot)

Rev.	Changes Summary	Performed	Checked	Date
Performed by			Page 7 / 36	Revision
Checked by				
Date	14/04/2022			

TORQUE AND CURRENT VS SPEED CURVE

Three Phase Induction Motor - Squirrel Cage



Customer :

Product line : NEMA Premium Efficiency Three-Phase

Product code : 11431460

Catalog # : 00218ST3QIE145T-W22

TORQUE AND CURRENT VS SPEED CURVE

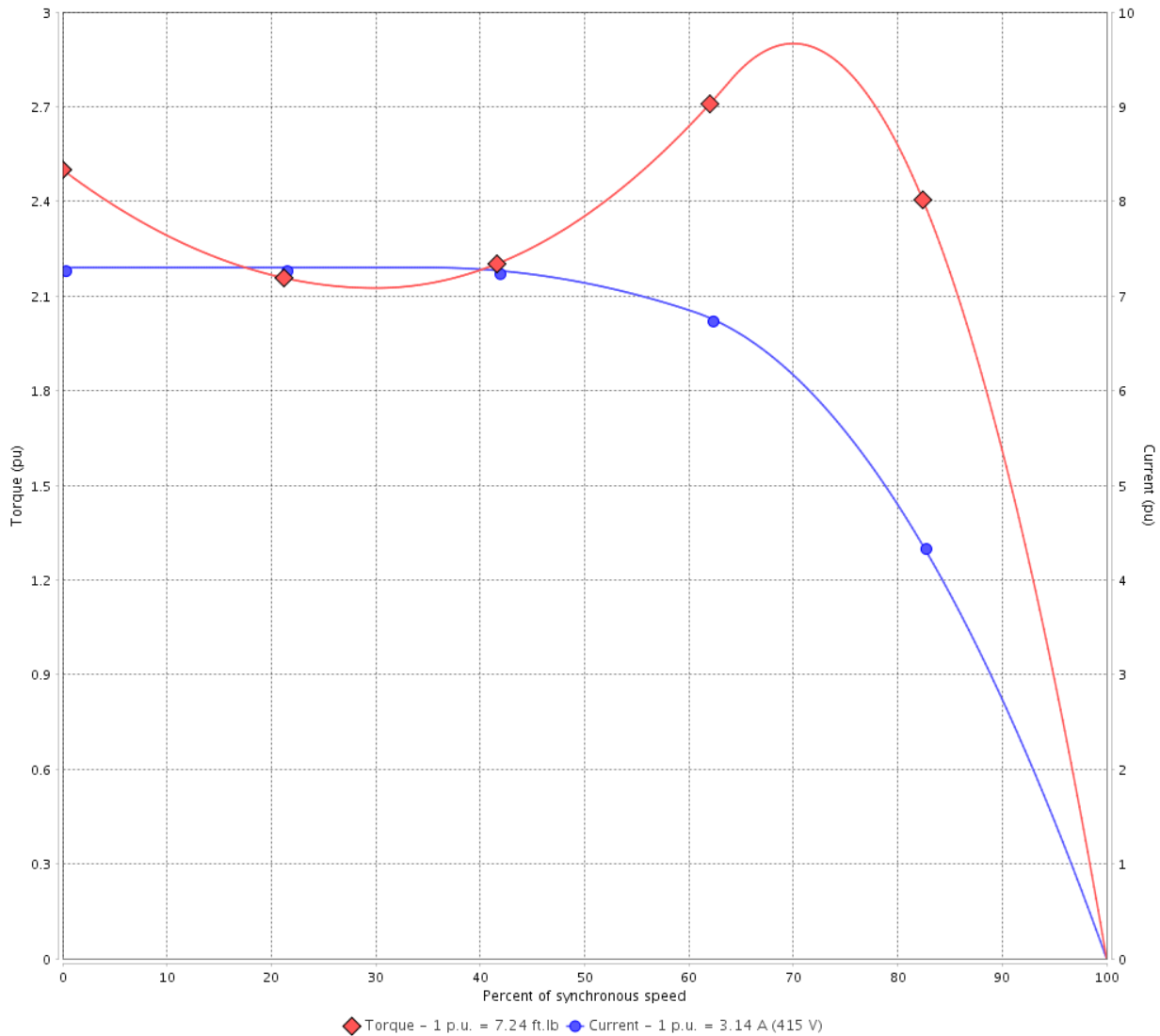

Performance : 415 V 50 Hz 4P IE2

Rated current	: 3.14 A	Moment of inertia (J)	: 0.1561 sq.ft.lb
LRC	: 7.3	Duty cycle	: Cont.(S1)
Rated torque	: 7.24 ft.lb	Insulation class	: F
Locked rotor torque	: 250 %	Service factor	: 1.25
Breakdown torque	: 290 %	Temperature rise	: 80 K
Rated speed	: 1450 rpm	Design	: B

Locked rotor time : 21s (cold) 12s (hot)

Rev.	Changes Summary	Performed	Checked	Date
Performed by			Page 8 / 36	Revision
Checked by				
Date	14/04/2022			

LOAD PERFORMANCE CURVE

Three Phase Induction Motor - Squirrel Cage



Customer :

Product line : NEMA Premium Efficiency Three-Phase

Product code : 11431460

Catalog # : 00218ST3QIE145T-W22

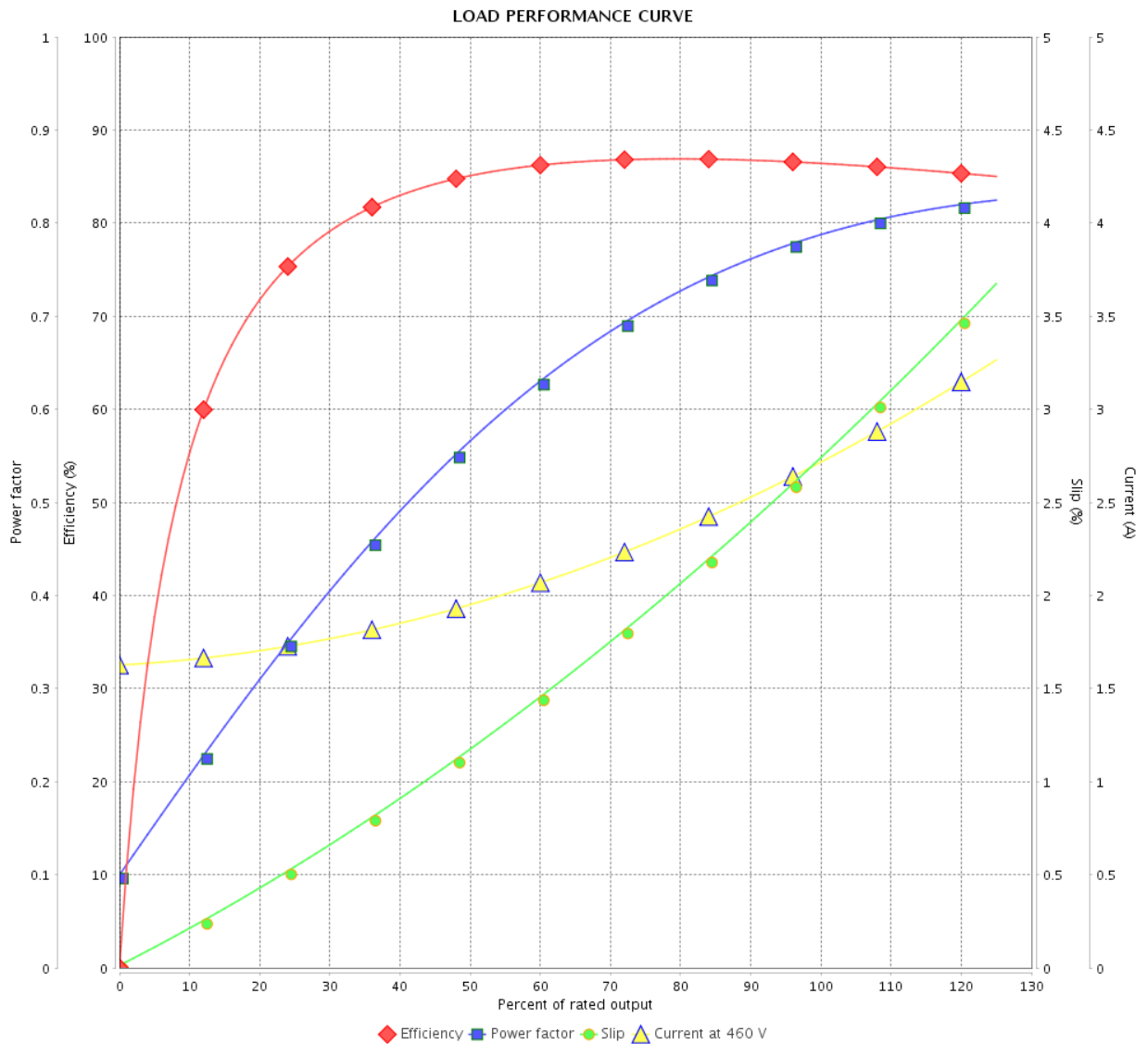

Performance : 460 V 60 Hz 4P

Rated current : 2.76 A
 LRC : 8.3
 Rated torque : 6.00 ft.lb
 Locked rotor torque : 270 %
 Breakdown torque : 320 %
 Rated speed : 1750 rpm

Moment of inertia (J) : 0.1561 sq.ft.lb
 Duty cycle : Cont.(S1)
 Insulation class : F
 Service factor : 1.25
 Temperature rise : 80 K
 Design : B

Rev.	Changes Summary	Performed	Checked	Date
Performed by		Page		Revision
Checked by		9 / 36		
Date		14/04/2022		

LOAD PERFORMANCE CURVE

Three Phase Induction Motor - Squirrel Cage



Customer :

Product line : NEMA Premium Efficiency Three-Phase

Product code : 11431460

Catalog # : 00218ST3QIE145T-W22

LOAD PERFORMANCE CURVE

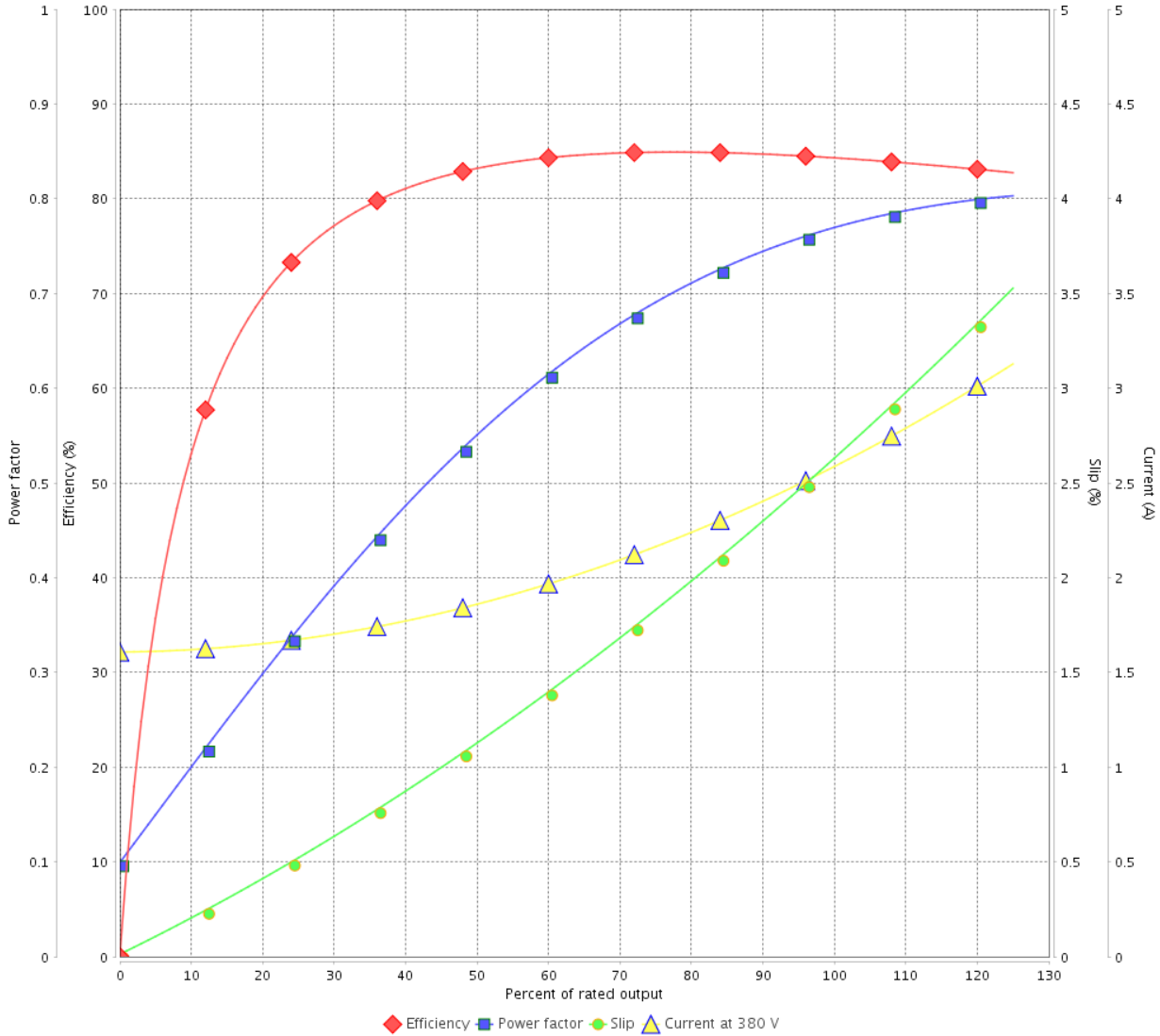

Performance : 380 V 50 Hz 4P IE3

Rated current : 2.57 A
 LRC : 8.2
 Rated torque : 5.40 ft.lb
 Locked rotor torque : 290 %
 Breakdown torque : 330 %
 Rated speed : 1460 rpm

Moment of inertia (J) : 0.1561 sq.ft.lb
 Duty cycle : Cont.(S1)
 Insulation class : F
 Service factor : 1.25
 Temperature rise : 80 K
 Design : B

Rev.	Changes Summary	Performed	Checked	Date
Performed by			Page 10 / 36	Revision
Checked by				
Date	14/04/2022			

LOAD PERFORMANCE CURVE

Three Phase Induction Motor - Squirrel Cage



Customer :

Product line : NEMA Premium Efficiency Three-Phase

Product code : 11431460

Catalog # : 00218ST3QIE145T-W22

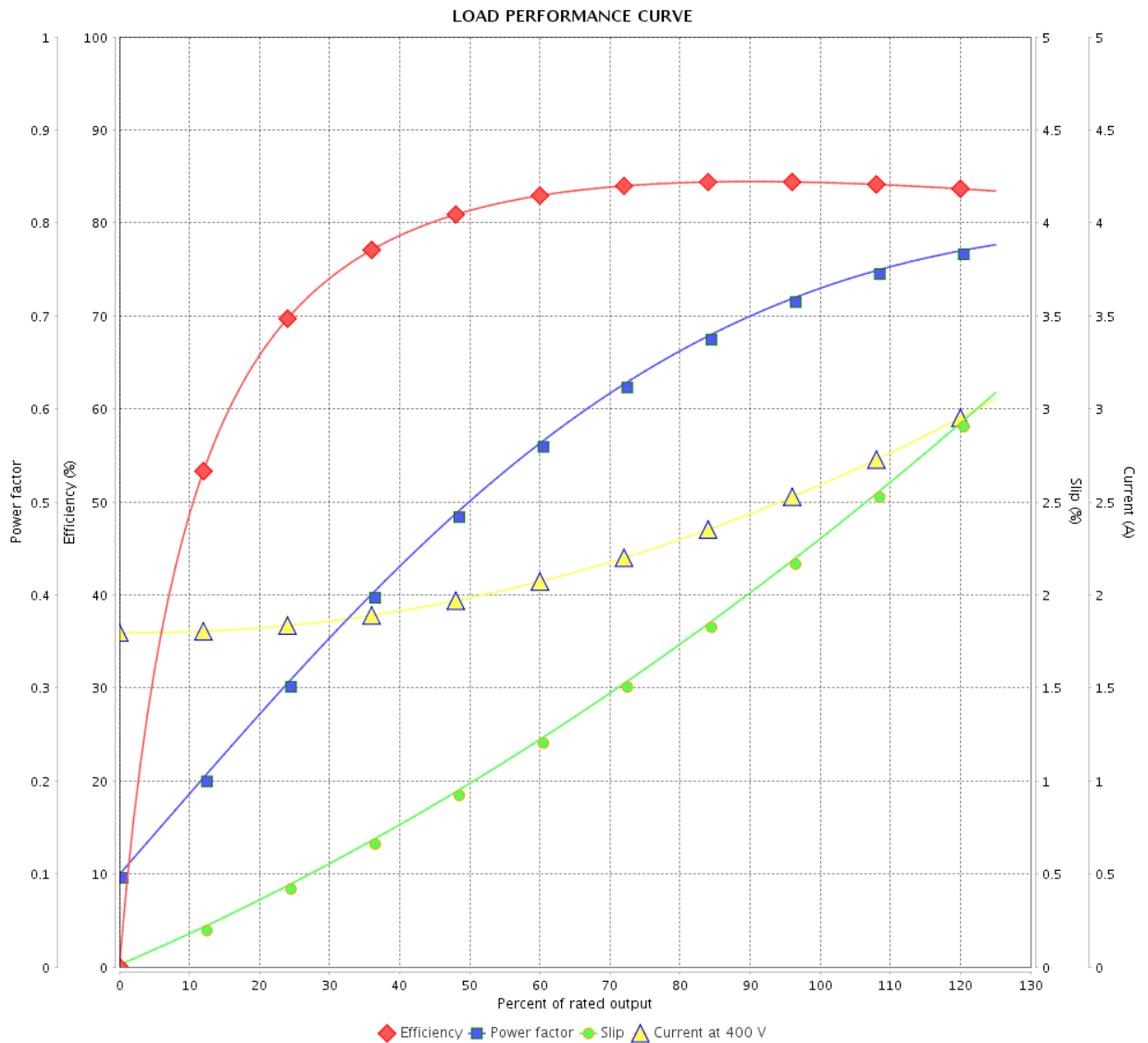

Performance : 400 V 50 Hz 4P IE3

Rated current : 2.57 A
 LRC : 8.7
 Rated torque : 5.38 ft.lb
 Locked rotor torque : 320 %
 Breakdown torque : 380 %
 Rated speed : 1465 rpm

Moment of inertia (J) : 0.1561 sq.ft.lb
 Duty cycle : Cont.(S1)
 Insulation class : F
 Service factor : 1.25
 Temperature rise : 80 K
 Design : B

Rev.	Changes Summary	Performed	Checked	Date
Performed by		Page		Revision
Checked by		11 / 36		
Date		14/04/2022		

LOAD PERFORMANCE CURVE

Three Phase Induction Motor - Squirrel Cage



Customer : _____

Product line : NEMA Premium Efficiency Three-Phase

Product code : 11431460

Catalog # : 00218ST3QIE145T-W22

LOAD PERFORMANCE CURVE

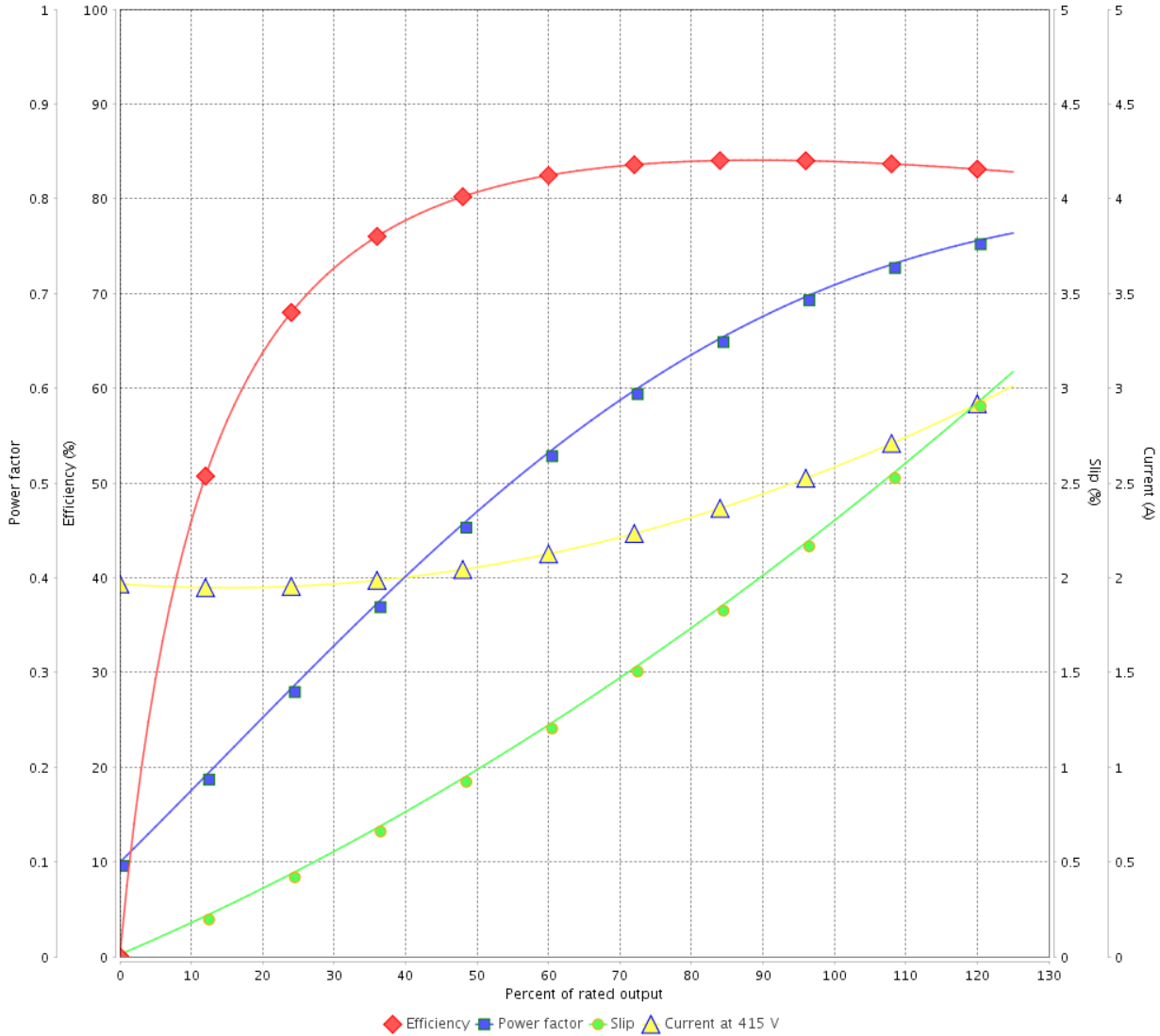

Performance : 415 V 50 Hz 4P IE3

Rated current : 2.56 A
 LRC : 8.4
 Rated torque : 5.38 ft.lb
 Locked rotor torque : 350 %
 Breakdown torque : 409 %
 Rated speed : 1465 rpm

Moment of inertia (J) : 0.1561 sq.ft.lb
 Duty cycle : Cont.(S1)
 Insulation class : F
 Service factor : 1.25
 Temperature rise : 80 K
 Design : B

Rev.	Changes Summary	Performed	Checked	Date
Performed by			Page 12 / 36	Revision
Checked by				
Date	14/04/2022			

LOAD PERFORMANCE CURVE

Three Phase Induction Motor - Squirrel Cage



Customer :

Product line : NEMA Premium Efficiency Three-Phase

Product code : 11431460

Catalog # : 00218ST3QIE145T-W22

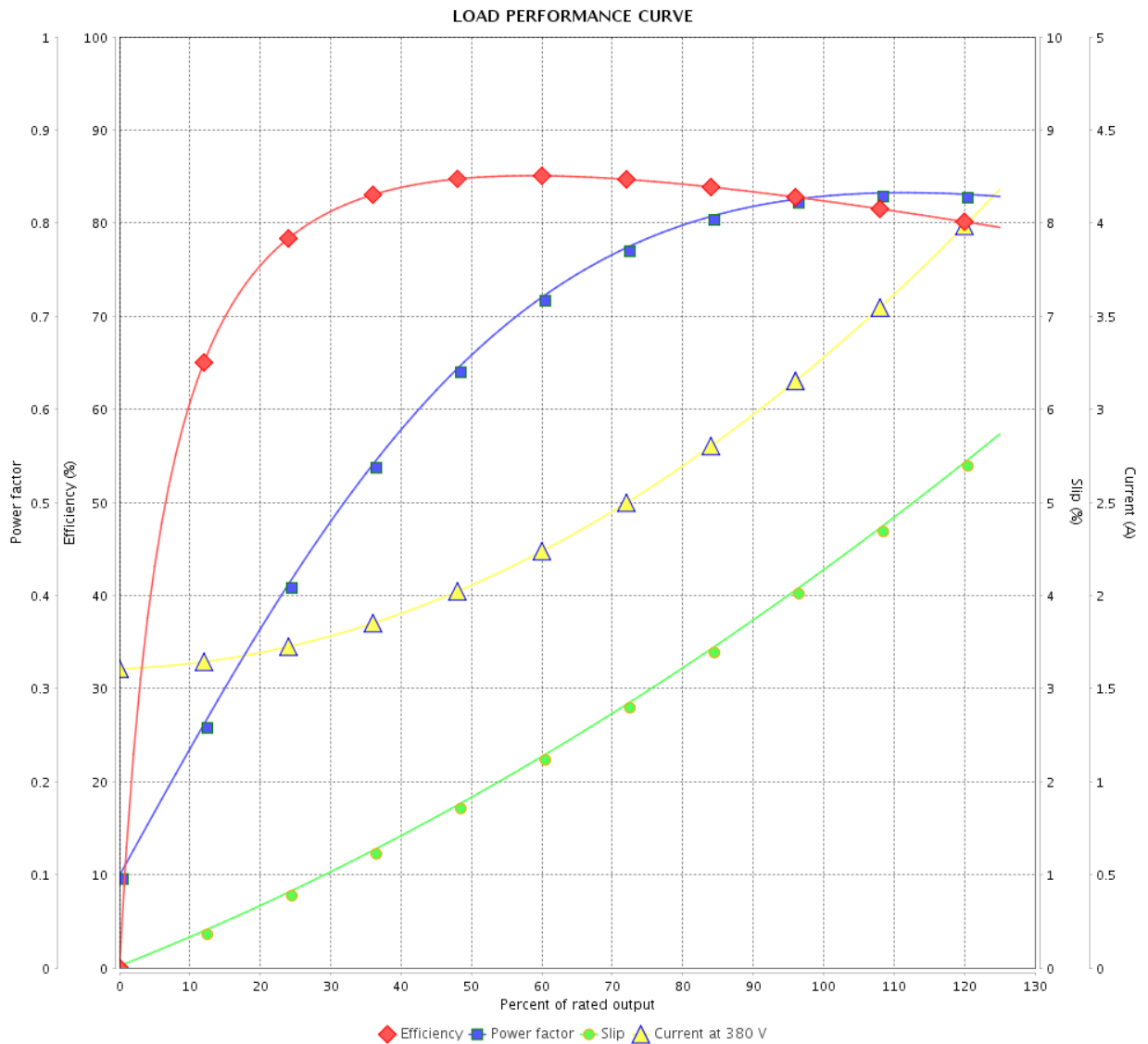

Performance : 380 V 50 Hz 4P IE1

Rated current : 3.33 A
 LRC : 6.0
 Rated torque : 7.32 ft.lb
 Locked rotor torque : 220 %
 Breakdown torque : 240 %
 Rated speed : 1435 rpm

Moment of inertia (J) : 0.1561 sq.ft.lb
 Duty cycle : Cont.(S1)
 Insulation class : F
 Service factor : 1.25
 Temperature rise : 80 K
 Design : B

Rev.	Changes Summary	Performed	Checked	Date
Performed by			Page	Revision
Checked by			13 / 36	
Date	14/04/2022			

LOAD PERFORMANCE CURVE

Three Phase Induction Motor - Squirrel Cage



Customer :

Product line : NEMA Premium Efficiency Three-Phase

Product code : 11431460

Catalog # : 00218ST3QIE145T-W22

LOAD PERFORMANCE CURVE

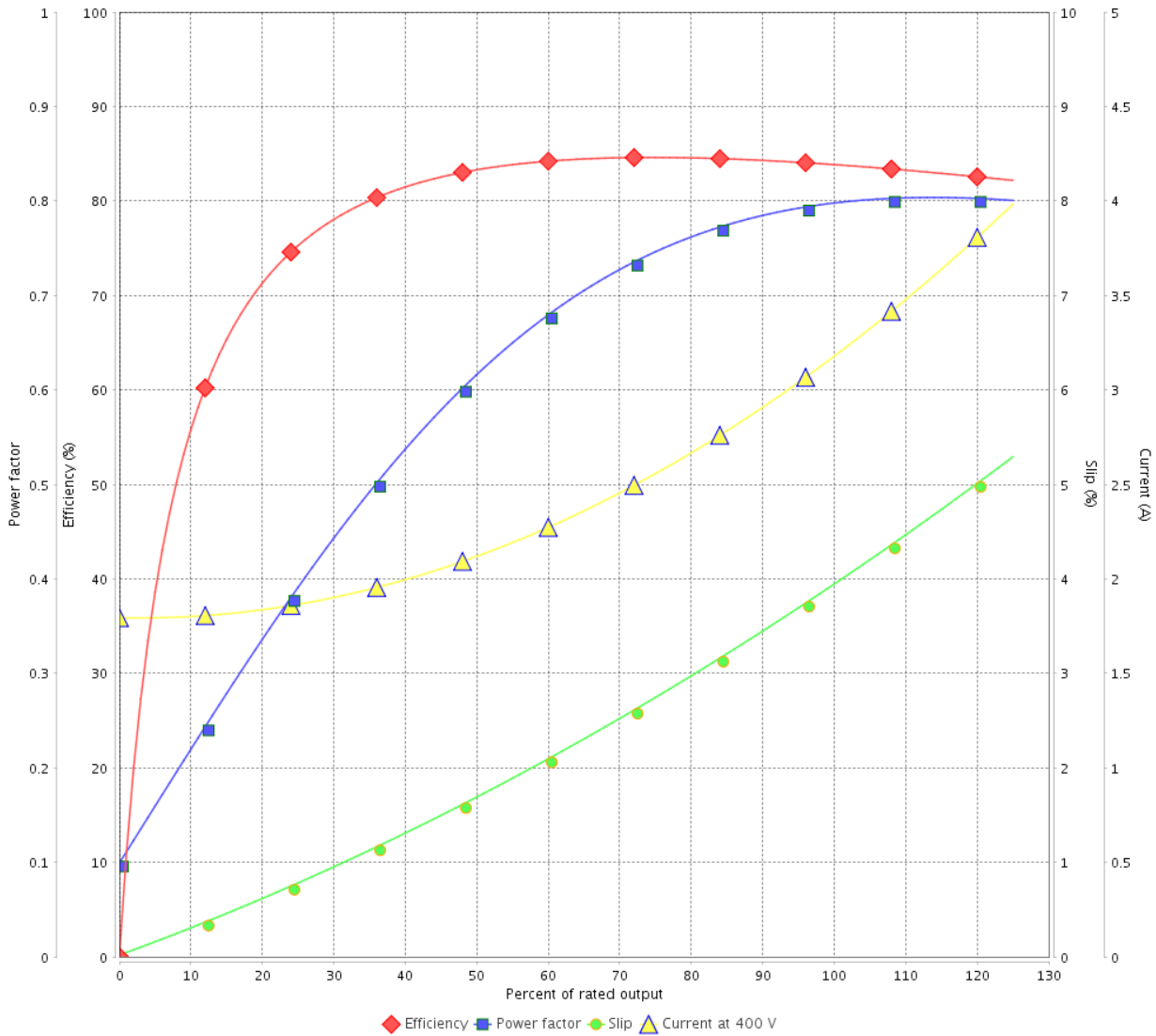

Performance : 400 V 50 Hz 4P IE2

Rated current : 3.22 A
 LRC : 6.6
 Rated torque : 7.29 ft.lb
 Locked rotor torque : 229 %
 Breakdown torque : 260 %
 Rated speed : 1440 rpm

Moment of inertia (J) : 0.1561 sq.ft.lb
 Duty cycle : Cont.(S1)
 Insulation class : F
 Service factor : 1.25
 Temperature rise : 80 K
 Design : B

Rev.	Changes Summary	Performed	Checked	Date
Performed by			Page 14 / 36	Revision
Checked by				
Date	14/04/2022			

LOAD PERFORMANCE CURVE

Three Phase Induction Motor - Squirrel Cage



Customer : _____

Product line : NEMA Premium Efficiency Three-Phase

Product code : 11431460

Catalog # : 00218ST3QIE145T-W22

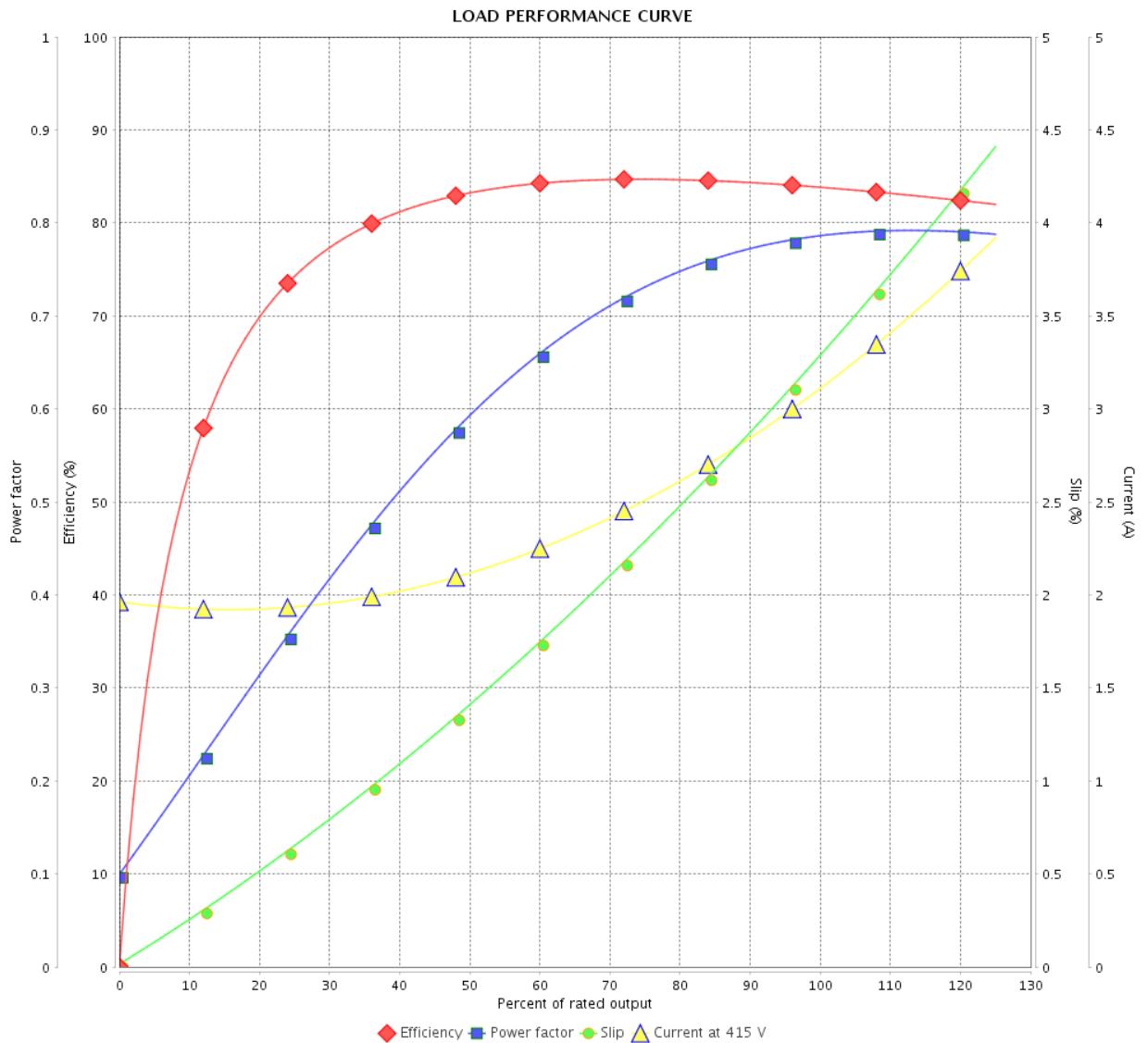

Performance : 415 V 50 Hz 4P IE2

Rated current : 3.14 A
 LRC : 7.3
 Rated torque : 7.24 ft.lb
 Locked rotor torque : 250 %
 Breakdown torque : 290 %
 Rated speed : 1450 rpm

Moment of inertia (J) : 0.1561 sq.ft.lb
 Duty cycle : Cont.(S1)
 Insulation class : F
 Service factor : 1.25
 Temperature rise : 80 K
 Design : B

Rev.	Changes Summary	Performed	Checked	Date
Performed by		Page		Revision
Checked by		15 / 36		
Date		14/04/2022		

THERMAL LIMIT CURVE

Three Phase Induction Motor - Squirrel Cage



Customer :

Product line : NEMA Premium Efficiency Three-Phase
Product code : 11431460
Catalog # : 00218ST3QIE145T-W22

Performance : 460 V 60 Hz 4P

Rated current	: 2.76 A	Moment of inertia (J)	: 0.1561 sq.ft.lb
LRC	: 8.3	Duty cycle	: Cont.(S1)
Rated torque	: 6.00 ft.lb	Insulation class	: F
Locked rotor torque	: 270 %	Service factor	: 1.25
Breakdown torque	: 320 %	Temperature rise	: 80 K
Rated speed	: 1750 rpm	Design	: B

Heating constant

Cooling constant

Rev.	Changes Summary	Performed	Checked	Date
Performed by				
Checked by			Page	Revision
Date	14/04/2022		16 / 36	

THERMAL LIMIT CURVE

Three Phase Induction Motor - Squirrel Cage



Customer : _____

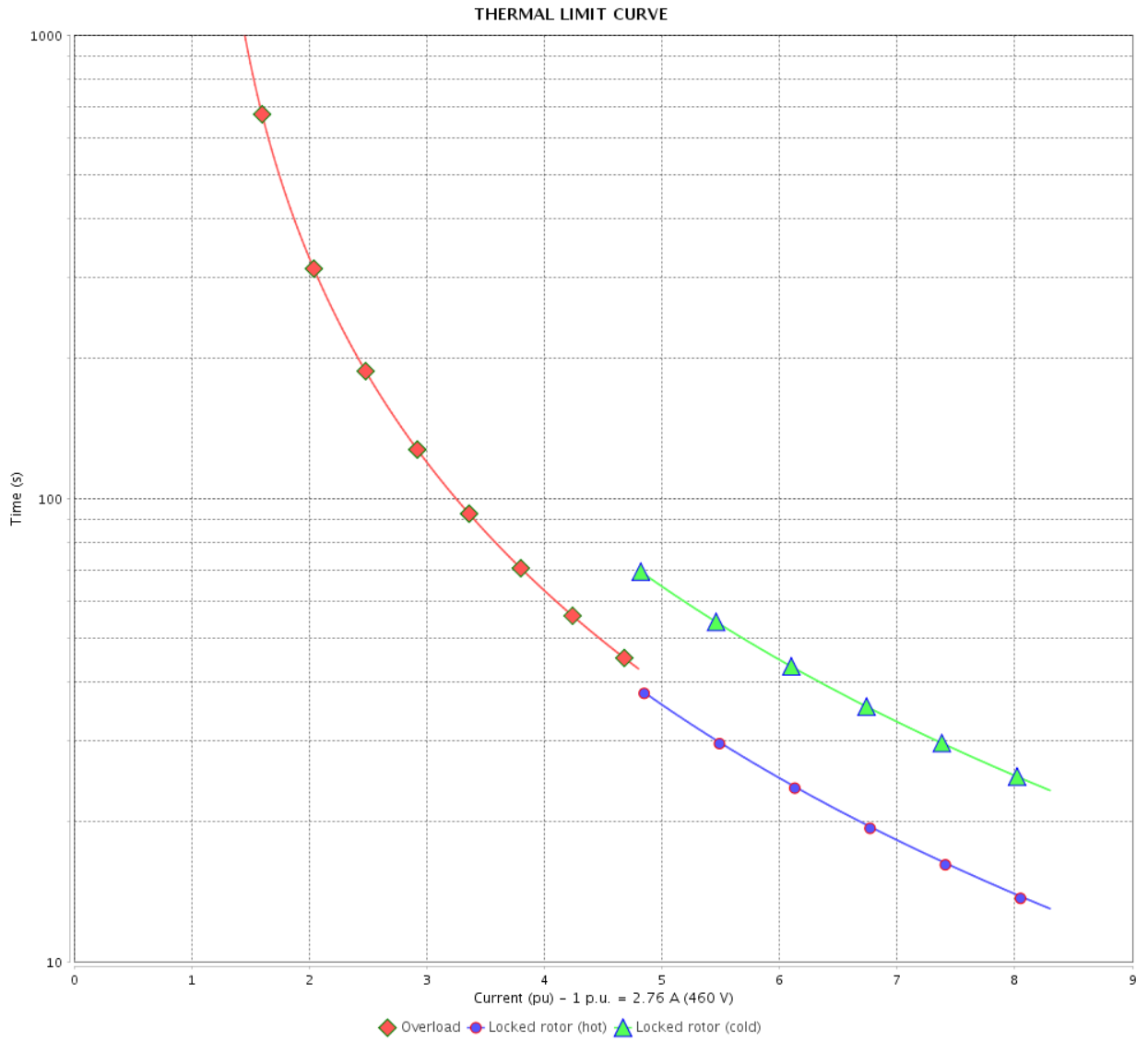

Rev.	Changes Summary	Performed	Checked	Date
Performed by		Page		Revision
Checked by		17 / 36		
Date		14/04/2022		

THERMAL LIMIT CURVE



Three Phase Induction Motor - Squirrel Cage

Customer :

Product line : NEMA Premium Efficiency Three-Phase
Product code : 11431460
Catalog # : 00218ST3QIE145T-W22

Performance : 380 V 50 Hz 4P IE3

Rated current	: 2.57 A	Moment of inertia (J)	: 0.1561 sq.ft.lb
LRC	: 8.2	Duty cycle	: Cont.(S1)
Rated torque	: 5.40 ft.lb	Insulation class	: F
Locked rotor torque	: 290 %	Service factor	: 1.25
Breakdown torque	: 330 %	Temperature rise	: 80 K
Rated speed	: 1460 rpm	Design	: B

Heating constant

Cooling constant

Rev.	Changes Summary	Performed	Checked	Date
Performed by				
Checked by			Page	Revision
Date	14/04/2022		18 / 36	

THERMAL LIMIT CURVE

Three Phase Induction Motor - Squirrel Cage



Customer : _____

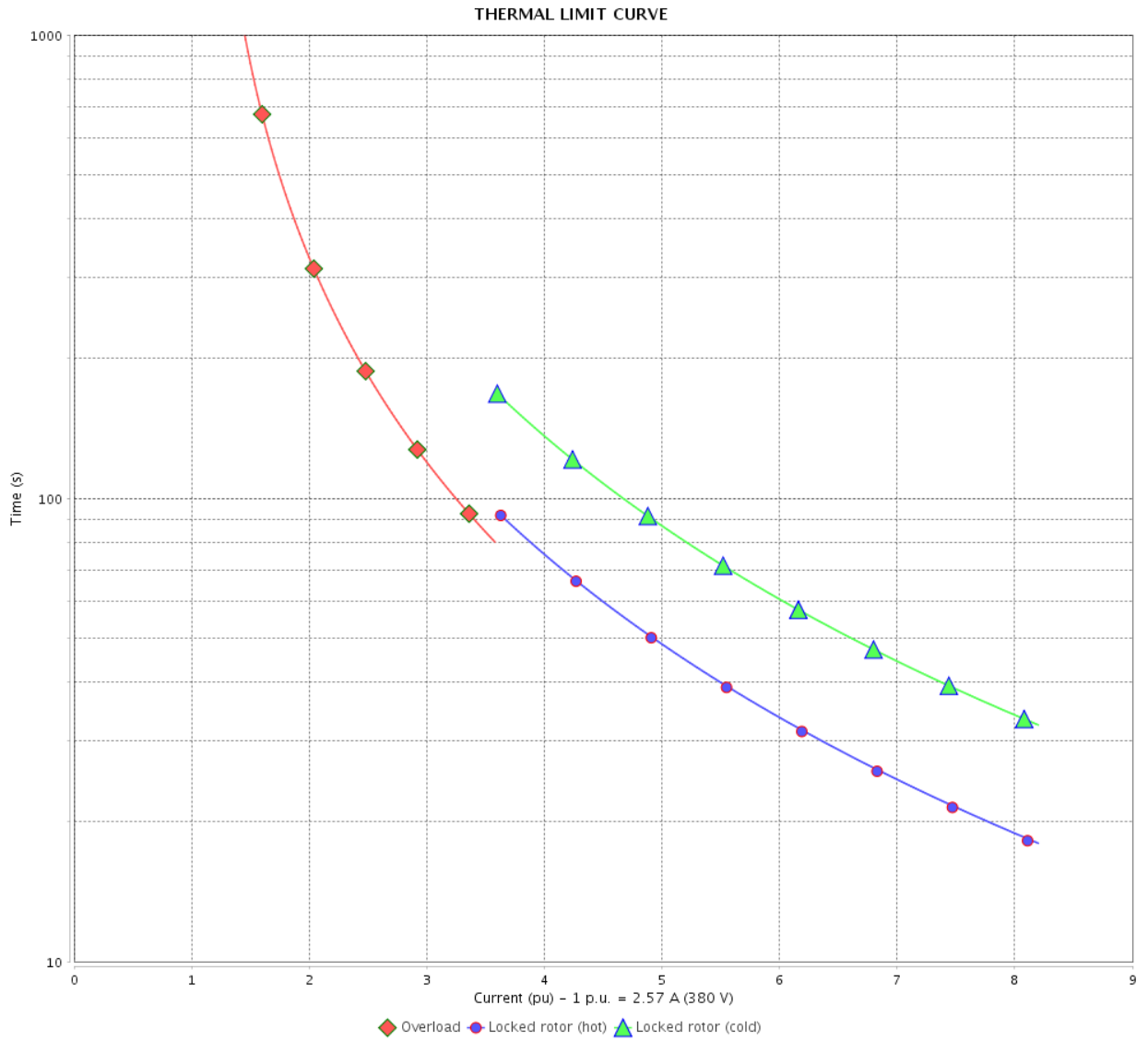

Rev.	Changes Summary	Performed	Checked	Date
Performed by		Page		Revision
Checked by		19 / 36		
Date		14/04/2022		

THERMAL LIMIT CURVE



Three Phase Induction Motor - Squirrel Cage

Customer :

Product line : NEMA Premium Efficiency Three-Phase
Product code : 11431460
Catalog # : 00218ST3QIE145T-W22

Performance : 400 V 50 Hz 4P IE3

Rated current	: 2.57 A	Moment of inertia (J)	: 0.1561 sq.ft.lb
LRC	: 8.7	Duty cycle	: Cont.(S1)
Rated torque	: 5.38 ft.lb	Insulation class	: F
Locked rotor torque	: 320 %	Service factor	: 1.25
Breakdown torque	: 380 %	Temperature rise	: 80 K
Rated speed	: 1465 rpm	Design	: B

Heating constant

Cooling constant

Rev.	Changes Summary	Performed	Checked	Date
Performed by				
Checked by			Page	Revision
Date	14/04/2022		20 / 36	

THERMAL LIMIT CURVE

Three Phase Induction Motor - Squirrel Cage



Customer : _____

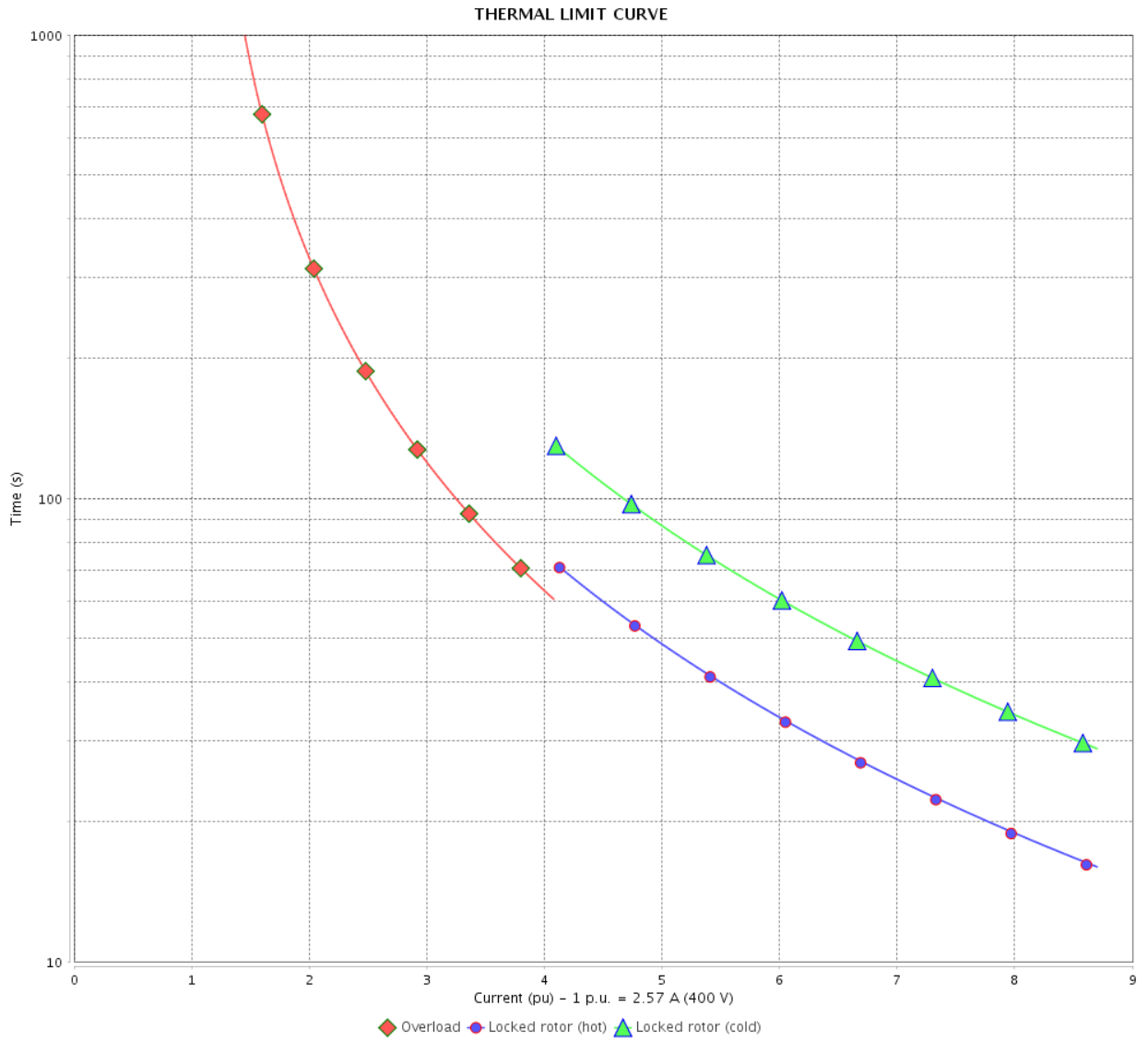

Rev.	Changes Summary	Performed	Checked	Date
Performed by		Page		Revision
Checked by		21 / 36		
Date		14/04/2022		

THERMAL LIMIT CURVE

Three Phase Induction Motor - Squirrel Cage



Customer :

Product line : NEMA Premium Efficiency Three-Phase
Product code : 11431460
Catalog # : 00218ST3QIE145T-W22

Performance : 415 V 50 Hz 4P IE3

Rated current	: 2.56 A	Moment of inertia (J)	: 0.1561 sq.ft.lb
LRC	: 8.4	Duty cycle	: Cont.(S1)
Rated torque	: 5.38 ft.lb	Insulation class	: F
Locked rotor torque	: 350 %	Service factor	: 1.25
Breakdown torque	: 409 %	Temperature rise	: 80 K
Rated speed	: 1465 rpm	Design	: B

Heating constant

Cooling constant

Rev.	Changes Summary	Performed	Checked	Date
Performed by				
Checked by			Page	Revision
Date	14/04/2022		22 / 36	

THERMAL LIMIT CURVE

Three Phase Induction Motor - Squirrel Cage



Customer : _____

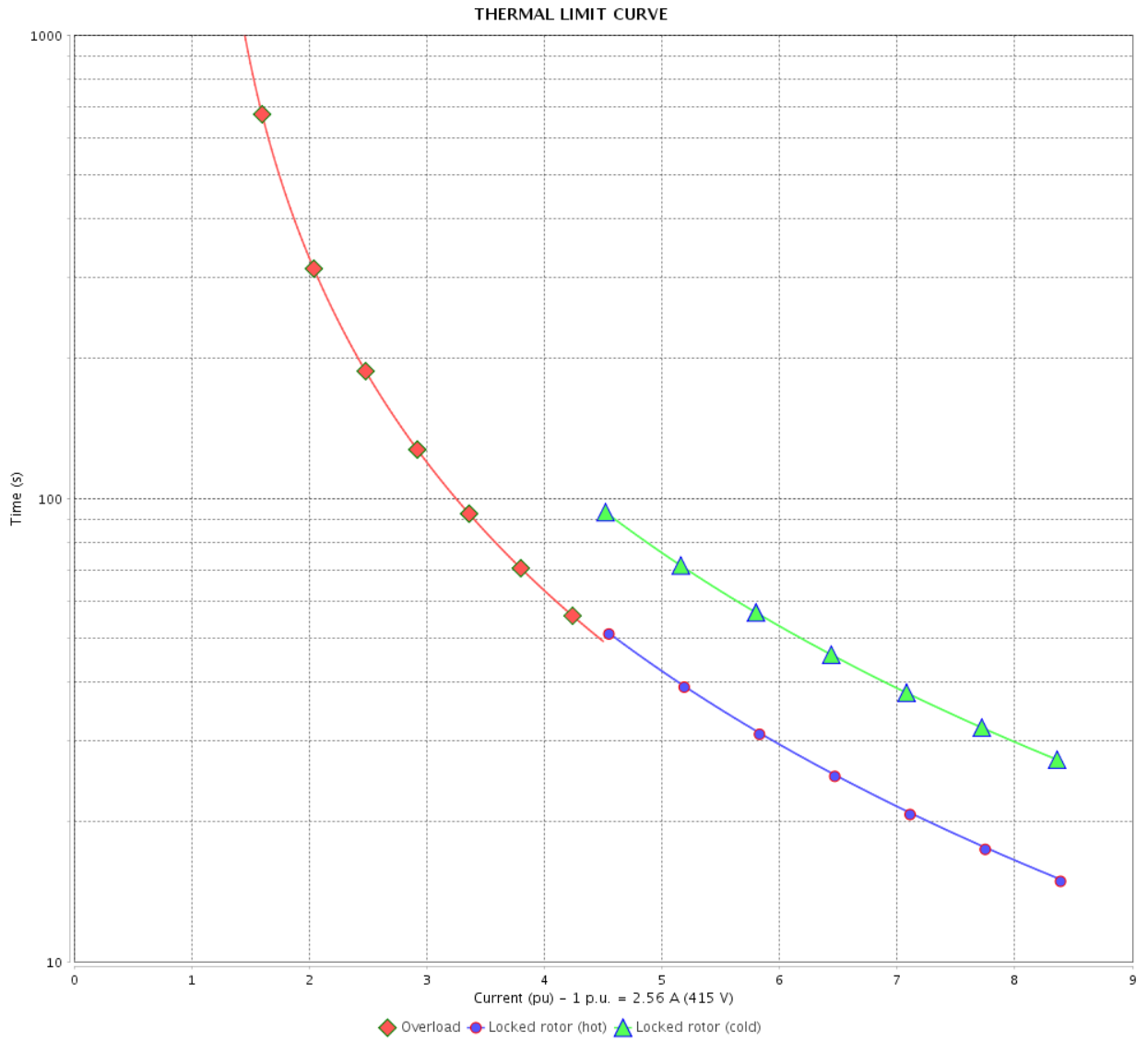

Rev.	Changes Summary	Performed	Checked	Date
Performed by		Page 23 / 36		Revision
Checked by				
Date				

THERMAL LIMIT CURVE



Three Phase Induction Motor - Squirrel Cage

Customer :

Product line : NEMA Premium Efficiency Three-Phase

Product code : 11431460

Catalog # : 00218ST3QIE145T-W22

Performance : 380 V 50 Hz 4P IE1

Rated current : 3.33 A
LRC : 6.0
Rated torque : 7.32 ft.lb
Locked rotor torque : 220 %
Breakdown torque : 240 %
Rated speed : 1435 rpm

Moment of inertia (J) : 0.1561 sq.ft.lb
Duty cycle : Cont.(S1)
Insulation class : F
Service factor : 1.25
Temperature rise : 80 K
Design : B

Heating constant

Cooling constant

Rev.	Changes Summary	Performed	Checked	Date
Performed by				
Checked by			Page	Revision
Date	14/04/2022		24 / 36	

THERMAL LIMIT CURVE

Three Phase Induction Motor - Squirrel Cage



Customer : _____

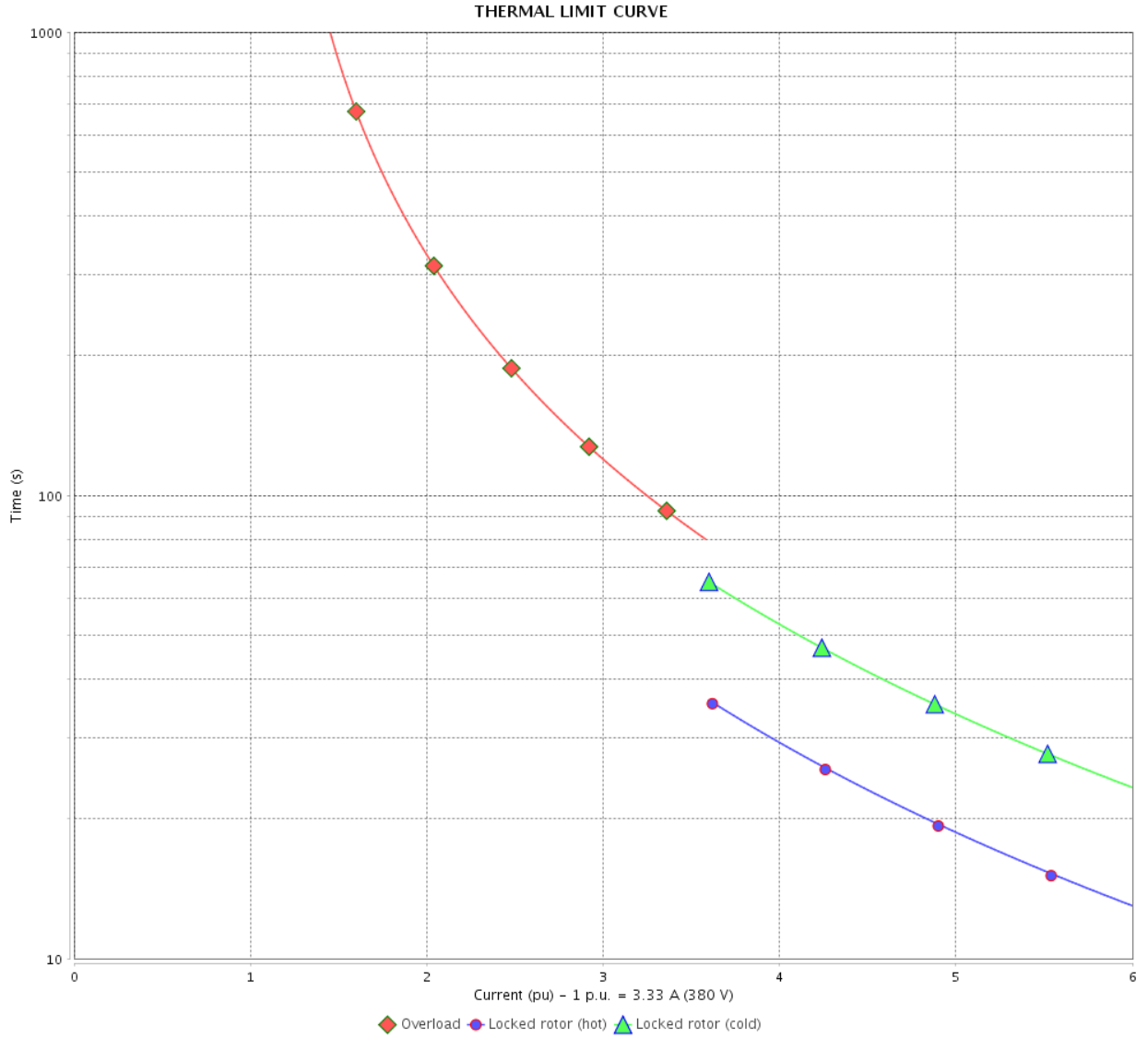

Rev.	Changes Summary	Performed	Checked	Date
Performed by		Page		Revision
Checked by		25 / 36		
Date		14/04/2022		

THERMAL LIMIT CURVE



Three Phase Induction Motor - Squirrel Cage

Customer :

Product line : NEMA Premium Efficiency Three-Phase
Product code : 11431460
Catalog # : 00218ST3QIE145T-W22

Performance : 400 V 50 Hz 4P IE2

Rated current	: 3.22 A	Moment of inertia (J)	: 0.1561 sq.ft.lb
LRC	: 6.6	Duty cycle	: Cont.(S1)
Rated torque	: 7.29 ft.lb	Insulation class	: F
Locked rotor torque	: 229 %	Service factor	: 1.25
Breakdown torque	: 260 %	Temperature rise	: 80 K
Rated speed	: 1440 rpm	Design	: B

Heating constant

Cooling constant

Rev.	Changes Summary	Performed	Checked	Date
Performed by				
Checked by			Page	Revision
Date	14/04/2022		26 / 36	

THERMAL LIMIT CURVE

Three Phase Induction Motor - Squirrel Cage



Customer : _____

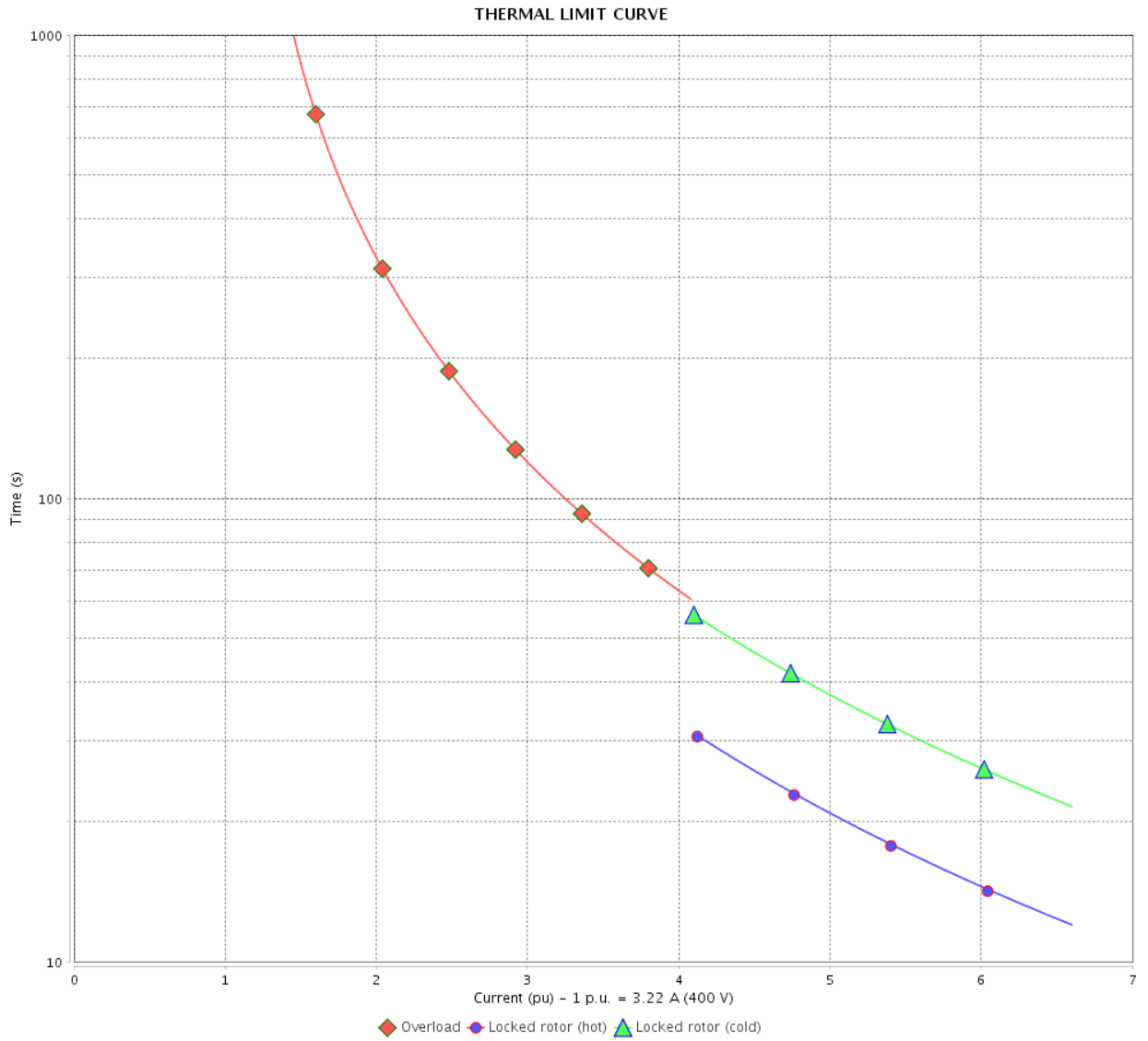

Rev.	Changes Summary	Performed	Checked	Date
Performed by		Page 27 / 36		Revision
Checked by				
Date				

THERMAL LIMIT CURVE



Three Phase Induction Motor - Squirrel Cage

Customer :

Product line : NEMA Premium Efficiency Three-Phase
Product code : 11431460
Catalog # : 00218ST3QIE145T-W22

Performance : 415 V 50 Hz 4P IE2

Rated current	: 3.14 A	Moment of inertia (J)	: 0.1561 sq.ft.lb
LRC	: 7.3	Duty cycle	: Cont.(S1)
Rated torque	: 7.24 ft.lb	Insulation class	: F
Locked rotor torque	: 250 %	Service factor	: 1.25
Breakdown torque	: 290 %	Temperature rise	: 80 K
Rated speed	: 1450 rpm	Design	: B

Heating constant

Cooling constant

Rev.	Changes Summary	Performed	Checked	Date
Performed by				
Checked by			Page	Revision
Date	14/04/2022		28 / 36	

THERMAL LIMIT CURVE

Three Phase Induction Motor - Squirrel Cage



Customer : _____

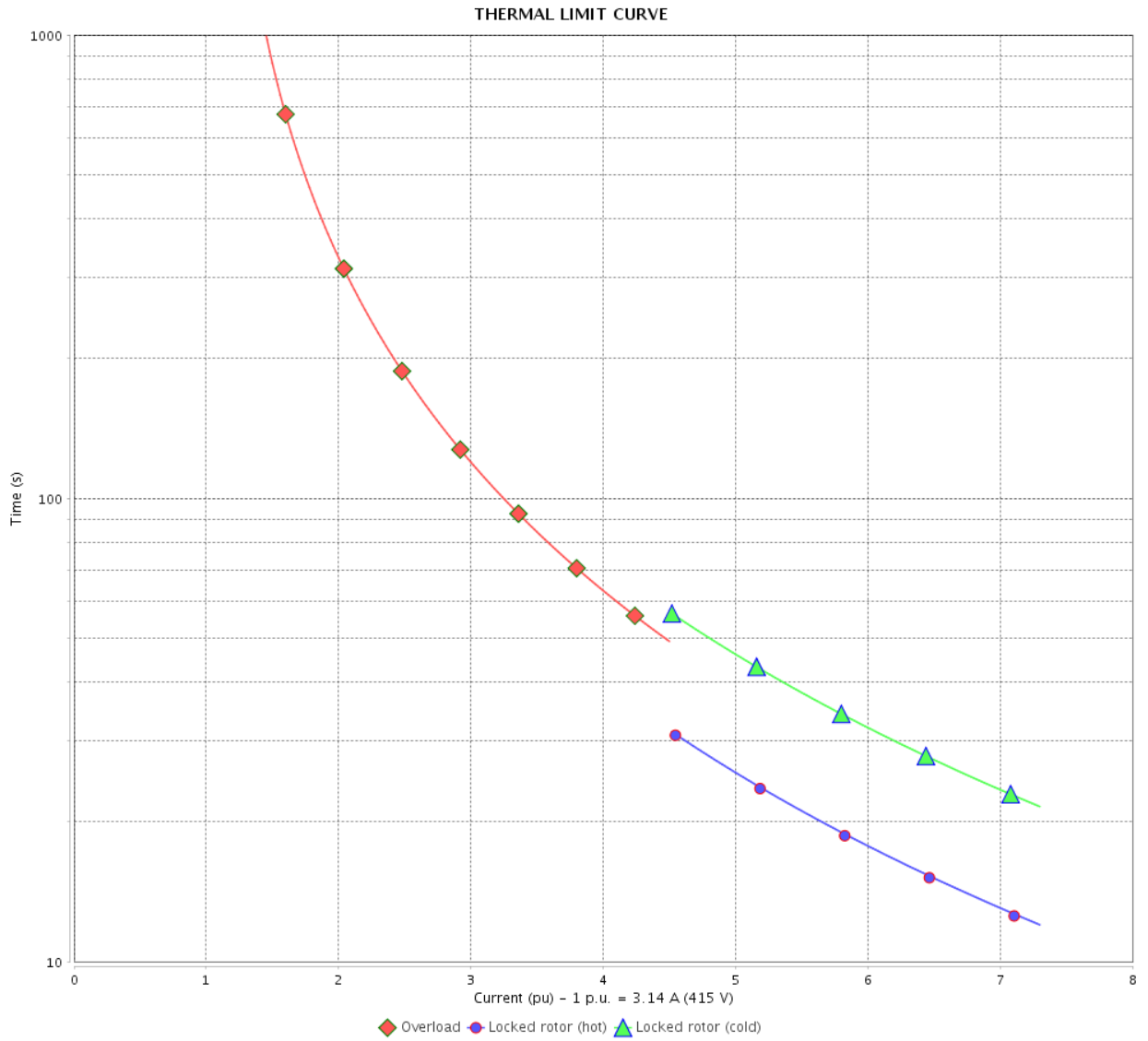

Rev.	Changes Summary	Performed	Checked	Date
Performed by		Page		Revision
Checked by		29 / 36		
Date		14/04/2022		

VFD OPERATION CURVE

Three Phase Induction Motor - Squirrel Cage



Customer :

Product line : NEMA Premium Efficiency Three-Phase

Product code : 11431460

Catalog # : 00218ST3QIE145T-W22

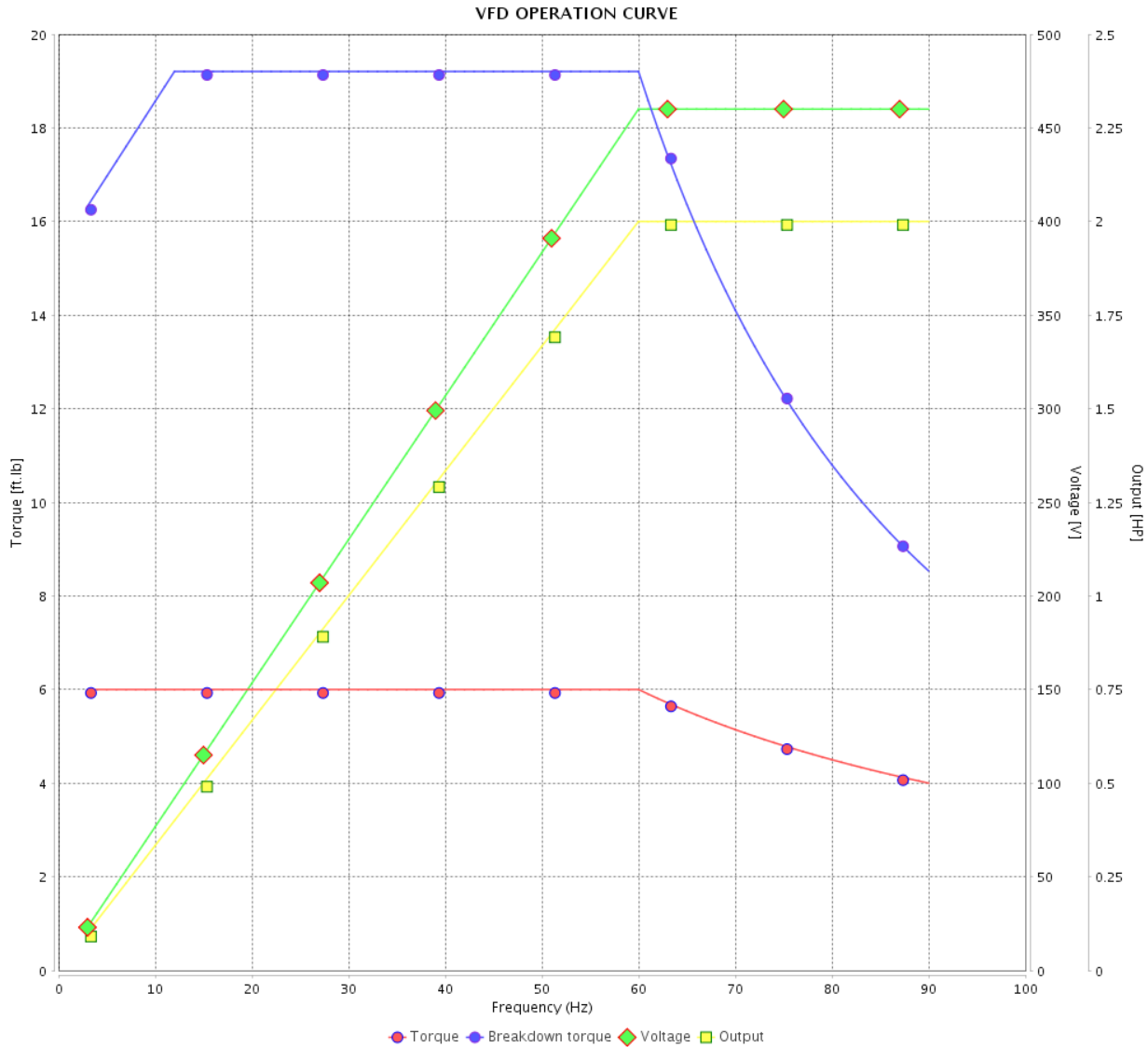

Performance : 460 V 60 Hz 4P

Rated current : 2.76 A
 LRC : 8.3
 Rated torque : 6.00 ft.lb
 Locked rotor torque : 270 %
 Breakdown torque : 320 %
 Rated speed : 1750 rpm

Moment of inertia (J) : 0.1561 sq.ft.lb
 Duty cycle : Cont.(S1)
 Insulation class : F
 Service factor : 1.25
 Temperature rise : 80 K
 Design : B

Rev.	Changes Summary	Performed	Checked	Date
Performed by			Page	Revision
Checked by				
Date				

VFD OPERATION CURVE

Three Phase Induction Motor - Squirrel Cage



Customer :

Product line : NEMA Premium Efficiency Three-Phase

Product code : 11431460

Catalog # : 00218ST3QIE145T-W22

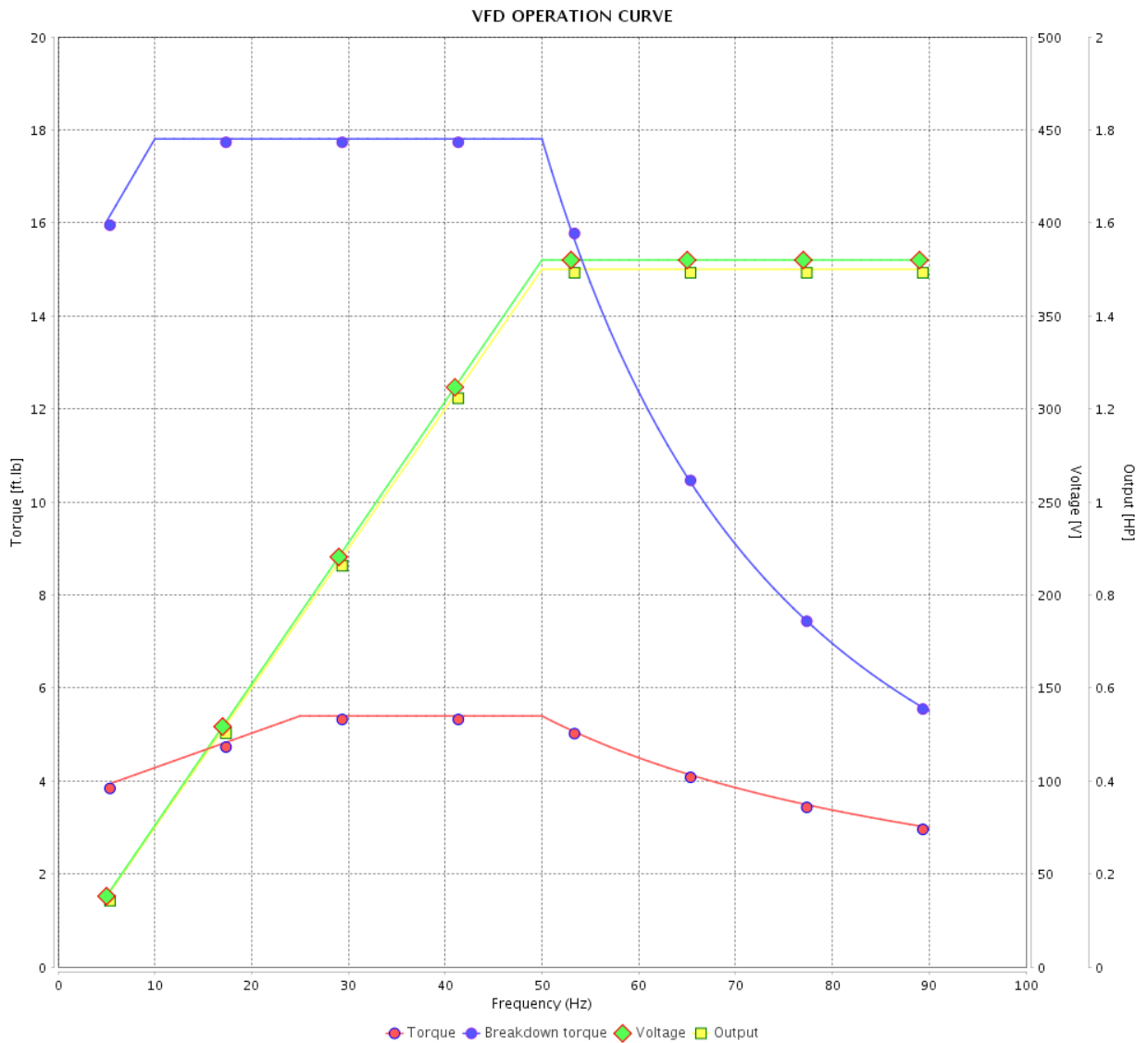

Performance : 380 V 50 Hz 4P IE3

Rated current : 2.57 A
 LRC : 8.2
 Rated torque : 5.40 ft.lb
 Locked rotor torque : 290 %
 Breakdown torque : 330 %
 Rated speed : 1460 rpm

Moment of inertia (J) : 0.1561 sq.ft.lb
 Duty cycle : Cont.(S1)
 Insulation class : F
 Service factor : 1.25
 Temperature rise : 80 K
 Design : B

Rev.	Changes Summary	Performed	Checked	Date
Performed by		Page		Revision
Checked by		31 / 36		
Date		14/04/2022		

VFD OPERATION CURVE

Three Phase Induction Motor - Squirrel Cage



Customer :

Product line : NEMA Premium Efficiency Three-Phase

Product code : 11431460

Catalog # : 00218ST3QIE145T-W22

VFD OPERATION CURVE

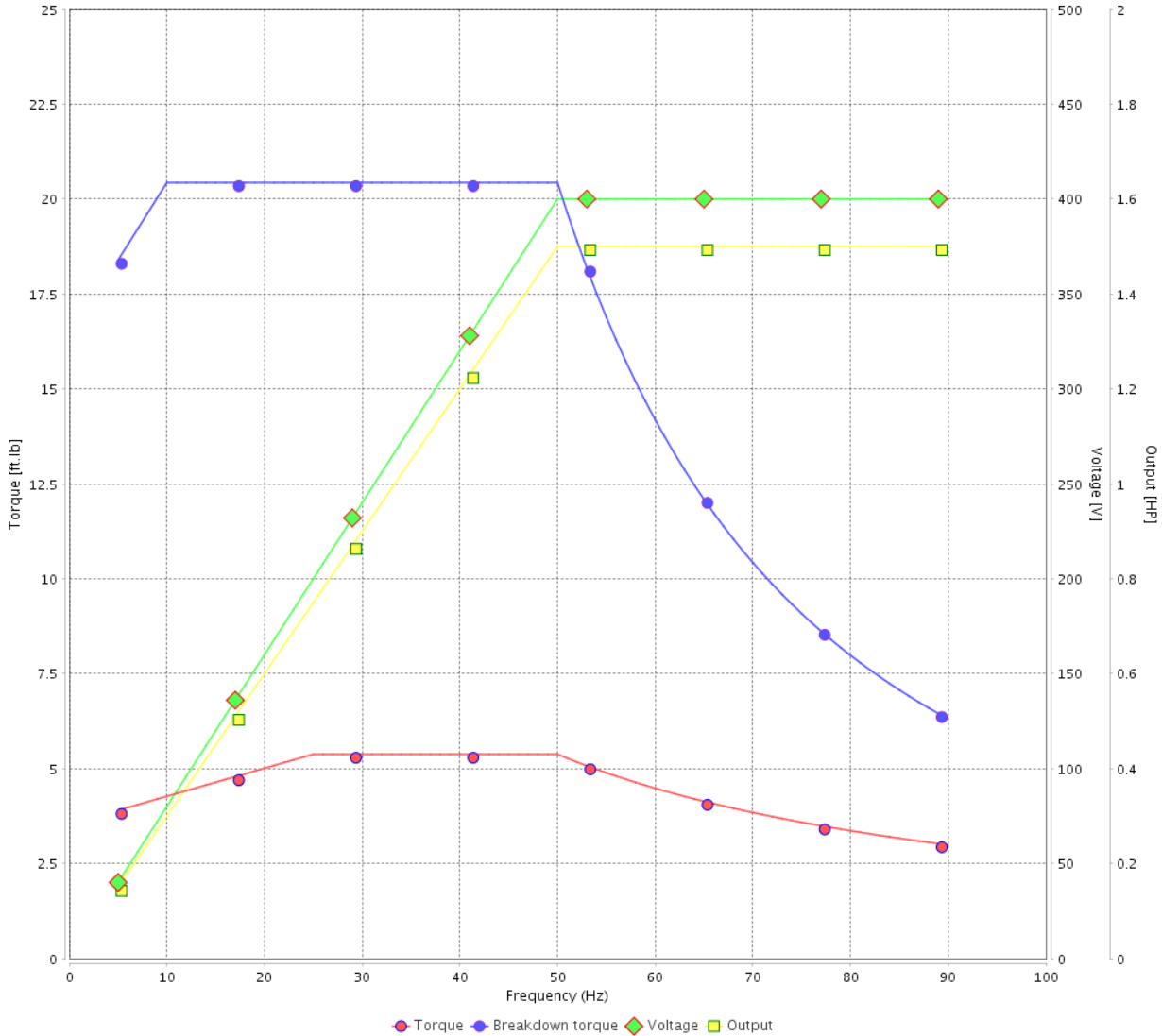

Performance : 400 V 50 Hz 4P IE3

Rated current : 2.57 A
 LRC : 8.7
 Rated torque : 5.38 ft.lb
 Locked rotor torque : 320 %
 Breakdown torque : 380 %
 Rated speed : 1465 rpm

Moment of inertia (J) : 0.1561 sq.ft.lb
 Duty cycle : Cont.(S1)
 Insulation class : F
 Service factor : 1.25
 Temperature rise : 80 K
 Design : B

Rev.	Changes Summary	Performed	Checked	Date
Performed by			Page 32 / 36	Revision
Checked by				
Date	14/04/2022			

VFD OPERATION CURVE

Three Phase Induction Motor - Squirrel Cage



Customer :

Product line : NEMA Premium Efficiency Three-Phase

Product code : 11431460

Catalog # : 00218ST3QIE145T-W22

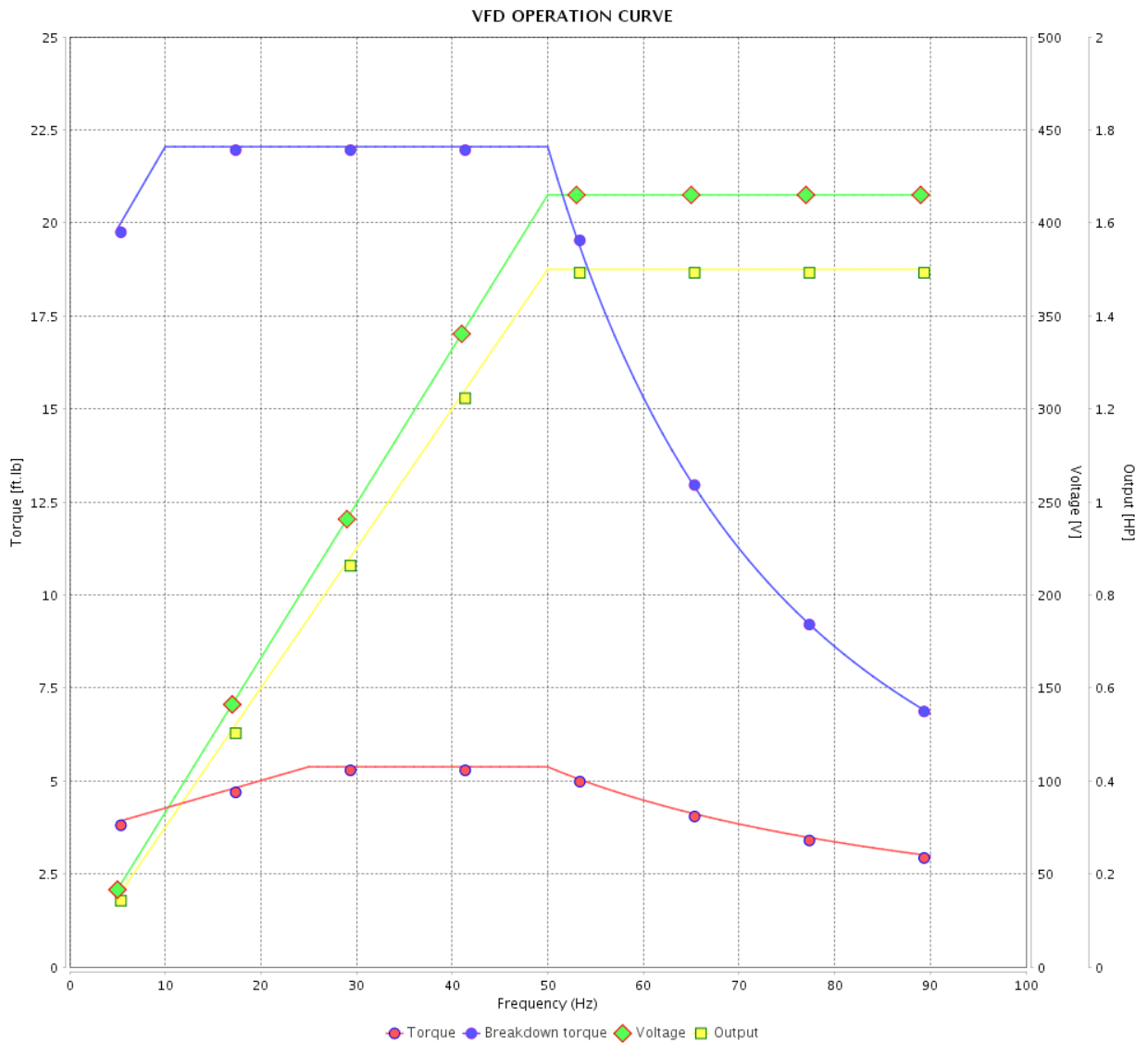

Performance : 415 V 50 Hz 4P IE3

Rated current : 2.56 A
 LRC : 8.4
 Rated torque : 5.38 ft.lb
 Locked rotor torque : 350 %
 Breakdown torque : 409 %
 Rated speed : 1465 rpm

Moment of inertia (J) : 0.1561 sq.ft.lb
 Duty cycle : Cont.(S1)
 Insulation class : F
 Service factor : 1.25
 Temperature rise : 80 K
 Design : B

Rev.	Changes Summary	Performed	Checked	Date
Performed by		Page		Revision
Checked by		33 / 36		
Date	14/04/2022			

VFD OPERATION CURVE

Three Phase Induction Motor - Squirrel Cage



Customer : _____

Product line : NEMA Premium Efficiency Three-Phase

Product code : 11431460

Catalog # : 00218ST3QIE145T-W22

VFD OPERATION CURVE

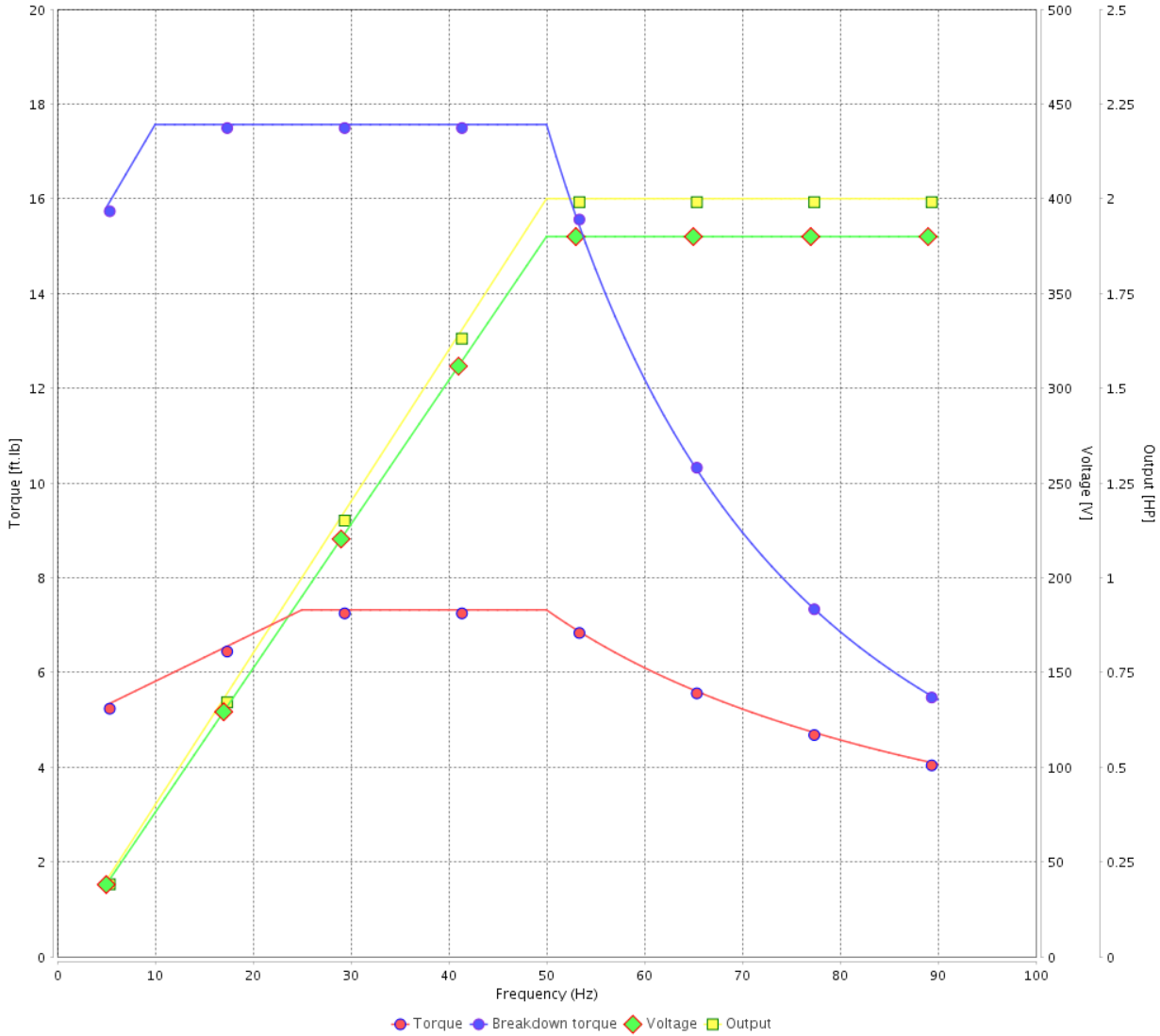

Performance : 380 V 50 Hz 4P IE1

Rated current : 3.33 A
 LRC : 6.0
 Rated torque : 7.32 ft.lb
 Locked rotor torque : 220 %
 Breakdown torque : 240 %
 Rated speed : 1435 rpm

Moment of inertia (J) : 0.1561 sq.ft.lb
 Duty cycle : Cont.(S1)
 Insulation class : F
 Service factor : 1.25
 Temperature rise : 80 K
 Design : B

Rev.	Changes Summary	Performed	Checked	Date
Performed by			Page	Revision
Checked by				
Date				

VFD OPERATION CURVE

Three Phase Induction Motor - Squirrel Cage



Customer : _____

Product line : NEMA Premium Efficiency Three-Phase

Product code : 11431460

Catalog # : 00218ST3QIE145T-W22

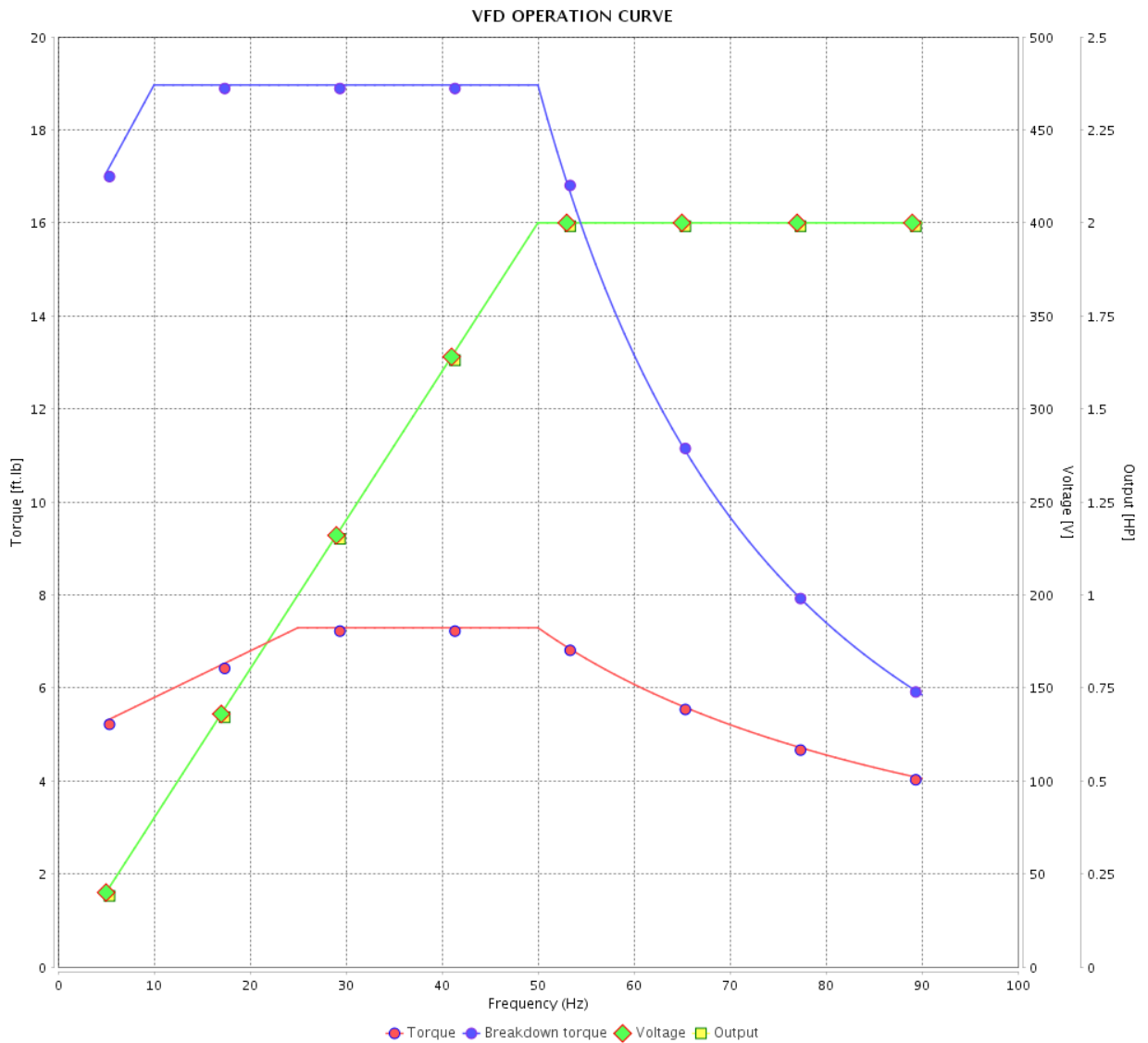

Performance : 400 V 50 Hz 4P IE2

Rated current : 3.22 A
 LRC : 6.6
 Rated torque : 7.29 ft.lb
 Locked rotor torque : 229 %
 Breakdown torque : 260 %
 Rated speed : 1440 rpm

Moment of inertia (J) : 0.1561 sq.ft.lb
 Duty cycle : Cont.(S1)
 Insulation class : F
 Service factor : 1.25
 Temperature rise : 80 K
 Design : B

Rev.	Changes Summary	Performed	Checked	Date
Performed by		Page		Revision
Checked by		35 / 36		
Date		14/04/2022		

VFD OPERATION CURVE

Three Phase Induction Motor - Squirrel Cage



Customer :

Product line : NEMA Premium Efficiency Three-Phase

Product code : 11431460

Catalog # : 00218ST3QIE145T-W22

VFD OPERATION CURVE

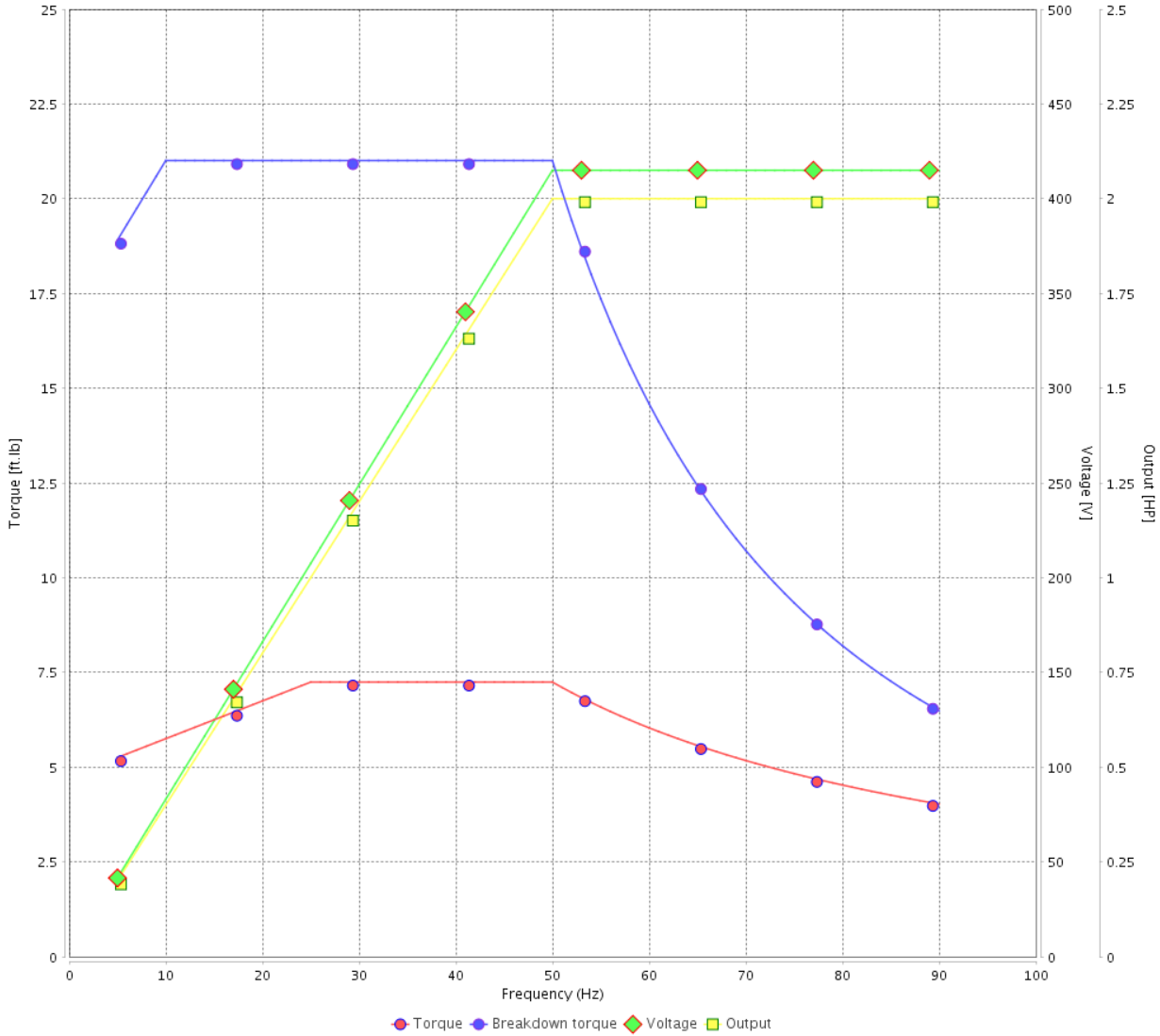

Performance : 415 V 50 Hz 4P IE2

Rated current	: 3.14 A	Moment of inertia (J)	: 0.1561 sq.ft.lb
LRC	: 7.3	Duty cycle	: Cont.(S1)
Rated torque	: 7.24 ft.lb	Insulation class	: F
Locked rotor torque	: 250 %	Service factor	: 1.25
Breakdown torque	: 290 %	Temperature rise	: 80 K
Rated speed	: 1450 rpm	Design	: B

Rev.	Changes Summary	Performed	Checked	Date
Performed by			Page 36 / 36	Revision
Checked by				
Date	14/04/2022			

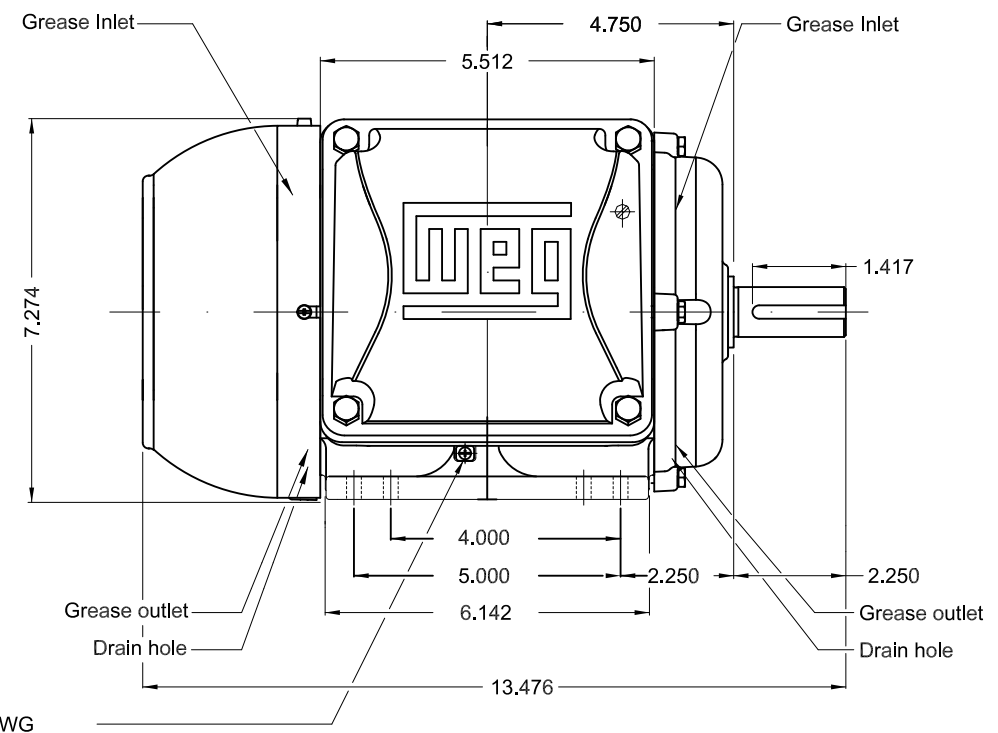
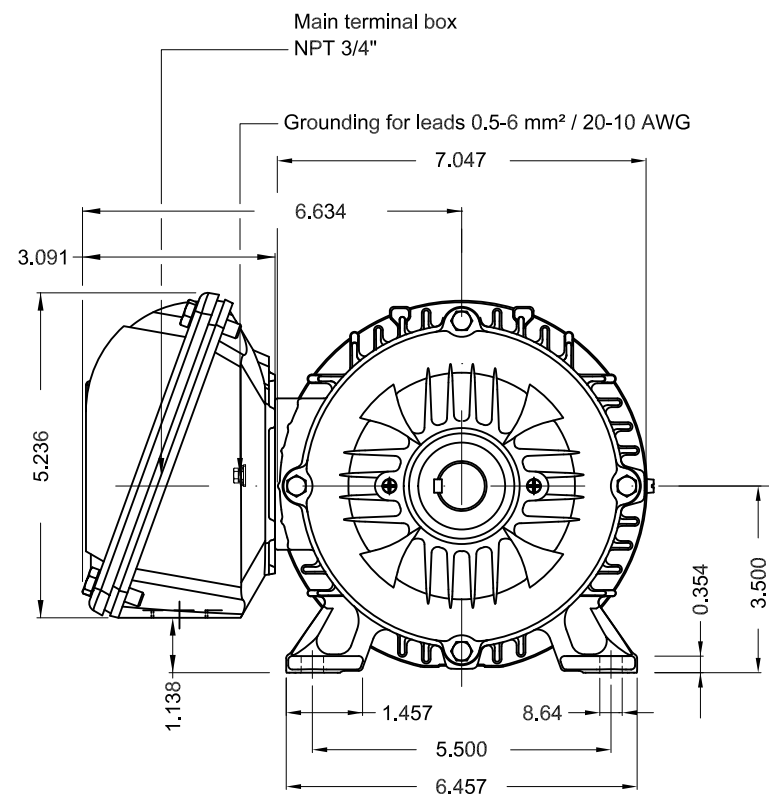

Grounding for leads 0.5-6 mm² / 20-10 AWG

Color RAL 5009
 Painting plan 202E
 Mounting B3R(D)

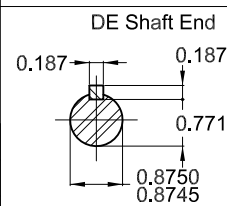

2 HP 04 Poles 60 Hz

Dimensions in inches

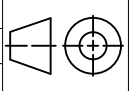
ECM	LOC	SUMMARY OF MODIFICATIONS	EXECUTED	CHECKED	RELEASED	DATE	VER
EXECUTED	PIRWBUSER	 THREE PH. MOTOR IEEE 841 W22 PREM. EFF. FRAME 143/5T IP55 TEFC					
CHECKED							
RELEASED							
REL DT.	WMO		Jaragua do Sul	Product Engineering	SHEET	1 / 1	

PREVIEW
 WDD



MADE IN BRAZIL
11431460



NEMA
Premium



Class I, Div 2, Gr A, B, C and D - T3
Class I, Zone 2, IIC - T3
Class II, Div 2, Gr F and G - T5
For use on PWM: Gr. A, B, C, D, F and G,
VT 1000:1, CT 20:1, 1.00SF - T4A

MODEL 00218ST3QIE145T-W22

Inverter Duty Motor
Severe Duty

IEEE
841-2009



FOR SAFE AREA
Mod. TE1BFOXON
CC029A

PH3 60Hz Fr. 143/5T 1000m.a.s.l. IP55 TEFC 61lb

V 460

A 2.76

HP 2.0

kW 1.5

SF 1.25

SFA 3.45

RPM 1750

PF 0.79

AMB 40°C

INS cl. F DT80K

NEMA NOM EFF 86.5%

DUTY CONT.

DES B Code L

GUARANT. EFF 84.0%

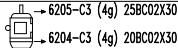
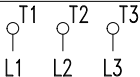

MOBIL POLYREX EM (20000h)

