

# DATA SHEET



## Three Phase Induction Motor - Squirrel Cage

Customer	:		
Product line	: Premium Efficiency Three-Phase	Product code :	14799195
		Catalog # :	00236ET3E56C-S
Frame	: 56HC	Cooling method	: IC411 - TEFC
Insulation class	: F	Mounting	: F-1
Duty cycle	: Cont.(S1)	Rotation <sup>1</sup>	: Both (CW and CCW)
Ambient temperature	: -20°C to +40°C	Starting method	: Direct On Line
Altitude	: 1000 m.a.s.l.	Approx. weight <sup>3</sup>	: 40.6 lb
Protection degree	: IP55	Moment of inertia (J)	: 0.1279 sq.ft.lb
Design	: B		
Output [HP]	2	2	2
Poles	2	2	2
Frequency [Hz]	60	50	50
Rated voltage [V]	230/460	190/380	220/415
Rated current [A]	4.94/2.47	5.94/2.97	5.39/2.86
L. R. Amperes [A]	48.9/24.5	44.0/22.0	44.2/23.5
LRC [A]	9.9x(Code L)	7.4x(Code J)	8.2x(Code K)
No load current [A]	2.13/1.06	2.10/1.05	2.14/1.13
Rated speed [RPM]	3520	2875	2890
Slip [%]	2.22	4.17	3.67
Rated torque [ft.lb]	2.98	3.65	3.63
Locked rotor torque [%]	250	229	260
Breakdown torque [%]	300	280	310
Service factor		1.15	1.15
Temperature rise	80 K	80 K	80 K
Locked rotor time	23s (cold) 13s (hot)	21s (cold) 12s (hot)	19s (cold) 11s (hot)
Noise level <sup>2</sup>	68.0 dB(A)	65.0 dB(A)	65.0 dB(A)
Efficiency (%)	25%	82.1	84.0
	50%	82.5	84.0
	75%	85.5	84.6
	100%	85.5	83.3
Power Factor	25%	0.45	0.51
	50%	0.73	0.79
	75%	0.83	0.88
	100%	0.89	0.92
Bearing type	: <u>Drive end</u> 6204 ZZ	<u>Non drive end</u> 6202 ZZ	Foundation loads
Sealing	: V'Ring	Without Bearing Seal	Max. traction : 90 lb
			Max. compression : 131 lb
Lubrication interval	: -	-	
Lubricant amount	: -	-	
Lubricant type	: Mobil Polyrex EM		
Notes			
USABLE @208V 5.46A SF 1.00 SFA 5.46A			
This revision replaces and cancel the previous one, which must be eliminated.		These are average values based on tests with sinusoidal power supply, subject to the tolerances stipulated in NEMA MG-1.	
(1) Looking the motor from the shaft end.			
(2) Measured at 1m and with tolerance of +3dB(A).			
(3) Approximate weight subject to changes after manufacturing process.			
(4) At 100% of full load.			
Rev.	Changes Summary	Performed	Checked
Performed by			
Checked by			
Date	13/04/2022		
		Page	Revision
		1 / 13	

# TORQUE AND CURRENT VS SPEED CURVE

Three Phase Induction Motor - Squirrel Cage



Customer :

Product line : Premium Efficiency Three-Phase      Product code : 14799195  
 Catalog # : 00236ET3E56C-S

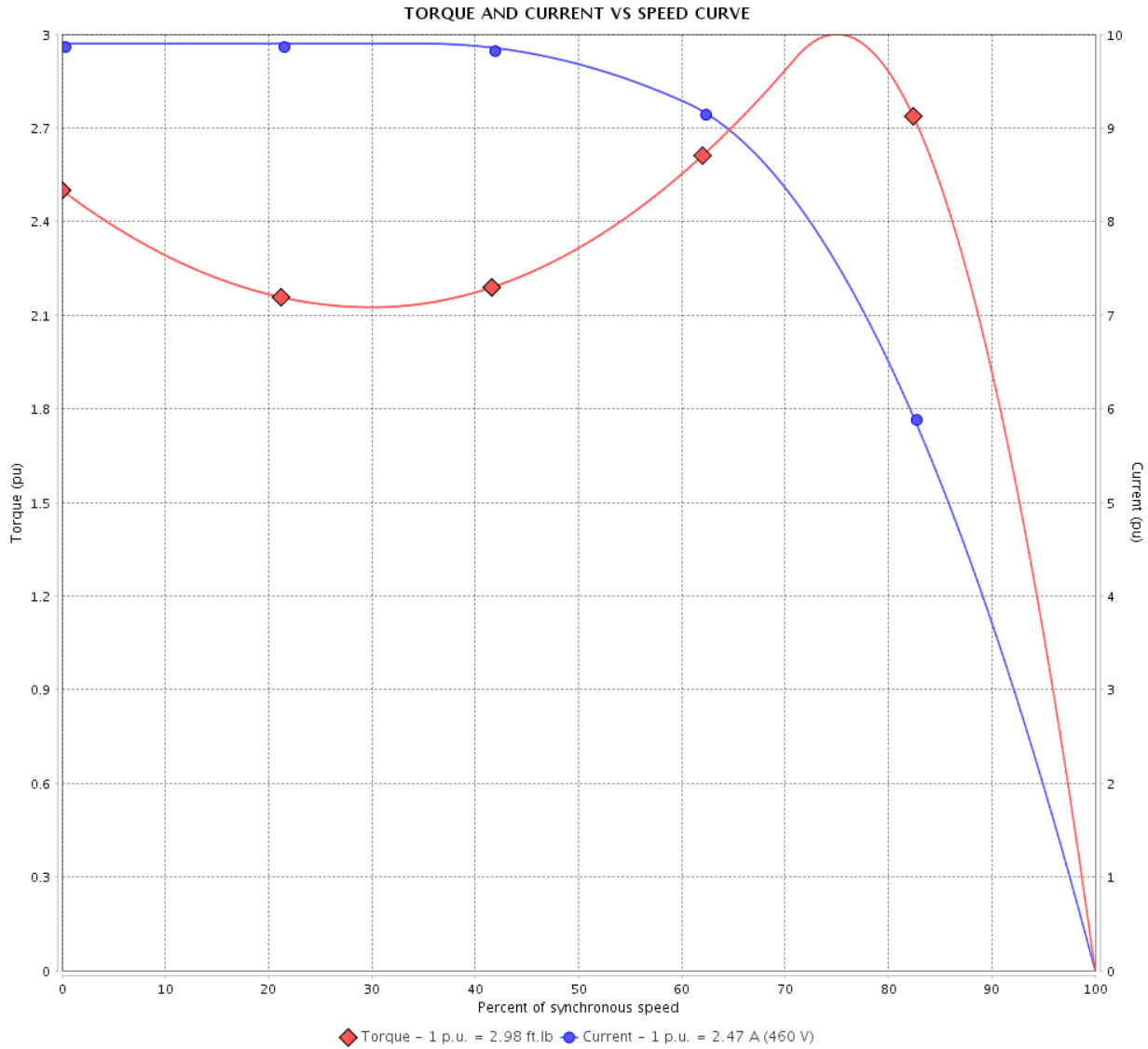

Performance : 230/460 V 60 Hz 2P

Rated current	: 4.94/2.47 A	Moment of inertia (J)	: 0.1279 sq.ft.lb
LRC	: 9.9	Duty cycle	: Cont.(S1)
Rated torque	: 2.98 ft.lb	Insulation class	: F
Locked rotor torque	: 250 %	Service factor	:
Breakdown torque	: 300 %	Temperature rise	: 80 K
Rated speed	: 3520 rpm	Design	: B

Locked rotor time : 23s (cold) 13s (hot)

Rev.	Changes Summary	Performed	Checked	Date
Performed by			Page 2 / 13	Revision
Checked by				
Date	13/04/2022			

# TORQUE AND CURRENT VS SPEED CURVE



## Three Phase Induction Motor - Squirrel Cage

Customer :

Product line : Premium Efficiency Three-Phase

Product code :

14799195

Catalog # :

00236ET3E56C-S

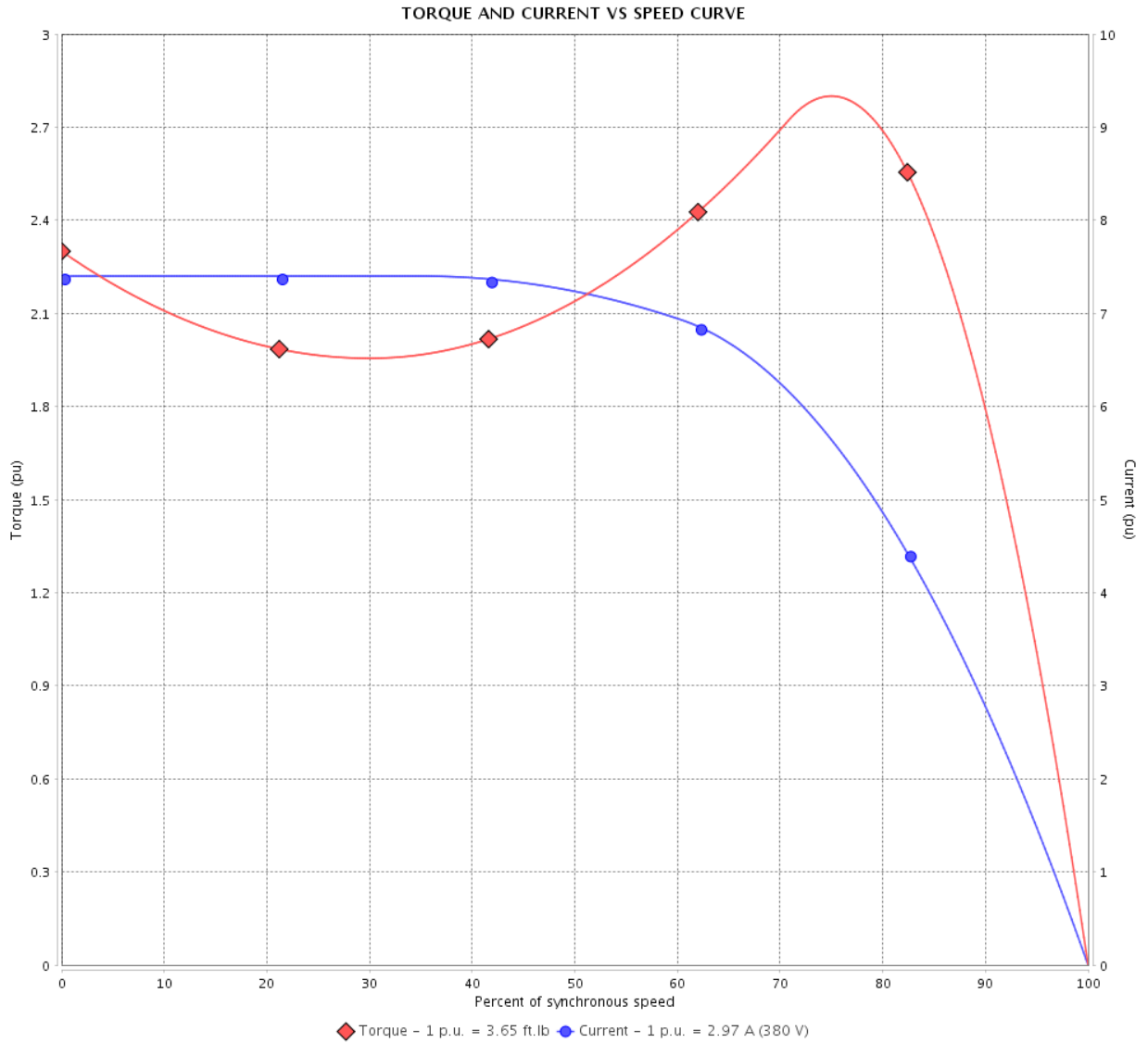

Performance : 190/380 V 50 Hz 2P

Rated current : 5.94/2.97 A  
 LRC : 7.4  
 Rated torque : 3.65 ft.lb  
 Locked rotor torque : 229 %  
 Breakdown torque : 280 %  
 Rated speed : 2875 rpm

Moment of inertia (J) : 0.1279 sq.ft.lb  
 Duty cycle : Cont.(S1)  
 Insulation class : F  
 Service factor : 1.15  
 Temperature rise : 80 K  
 Design : B

Locked rotor time : 21s (cold) 12s (hot)

Rev.	Changes Summary	Performed	Checked	Date
Performed by			Page 3 / 13	Revision
Checked by				
Date	13/04/2022			

# TORQUE AND CURRENT VS SPEED CURVE

Three Phase Induction Motor - Squirrel Cage



Customer :

Product line : Premium Efficiency Three-Phase      Product code : 14799195  
 Catalog # : 00236ET3E56C-S

TORQUE AND CURRENT VS SPEED CURVE

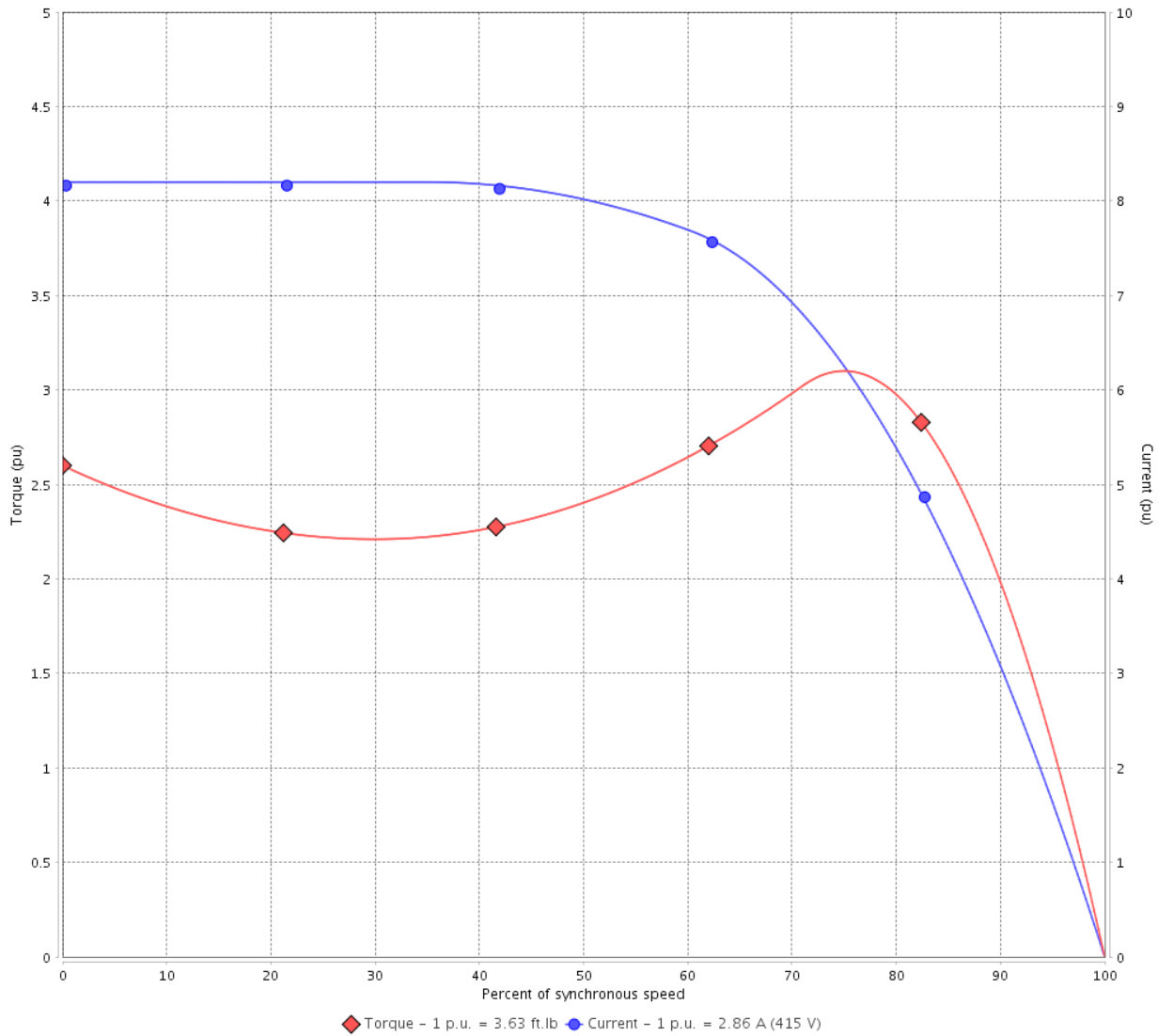

Performance : 220/415 V 50 Hz 2P

Rated current	: 5.39/2.86 A	Moment of inertia (J)	: 0.1279 sq.ft.lb
LRC	: 8.2	Duty cycle	: Cont.(S1)
Rated torque	: 3.63 ft.lb	Insulation class	: F
Locked rotor torque	: 260 %	Service factor	: 1.15
Breakdown torque	: 310 %	Temperature rise	: 80 K
Rated speed	: 2890 rpm	Design	: B

Locked rotor time : 19s (cold) 11s (hot)

Rev.	Changes Summary	Performed	Checked	Date
Performed by			Page 4 / 13	Revision
Checked by				
Date	13/04/2022			

# LOAD PERFORMANCE CURVE

Three Phase Induction Motor - Squirrel Cage



Customer :

Product line : Premium Efficiency Three-Phase

Product code :

14799195

Catalog # :

00236ET3E56C-S

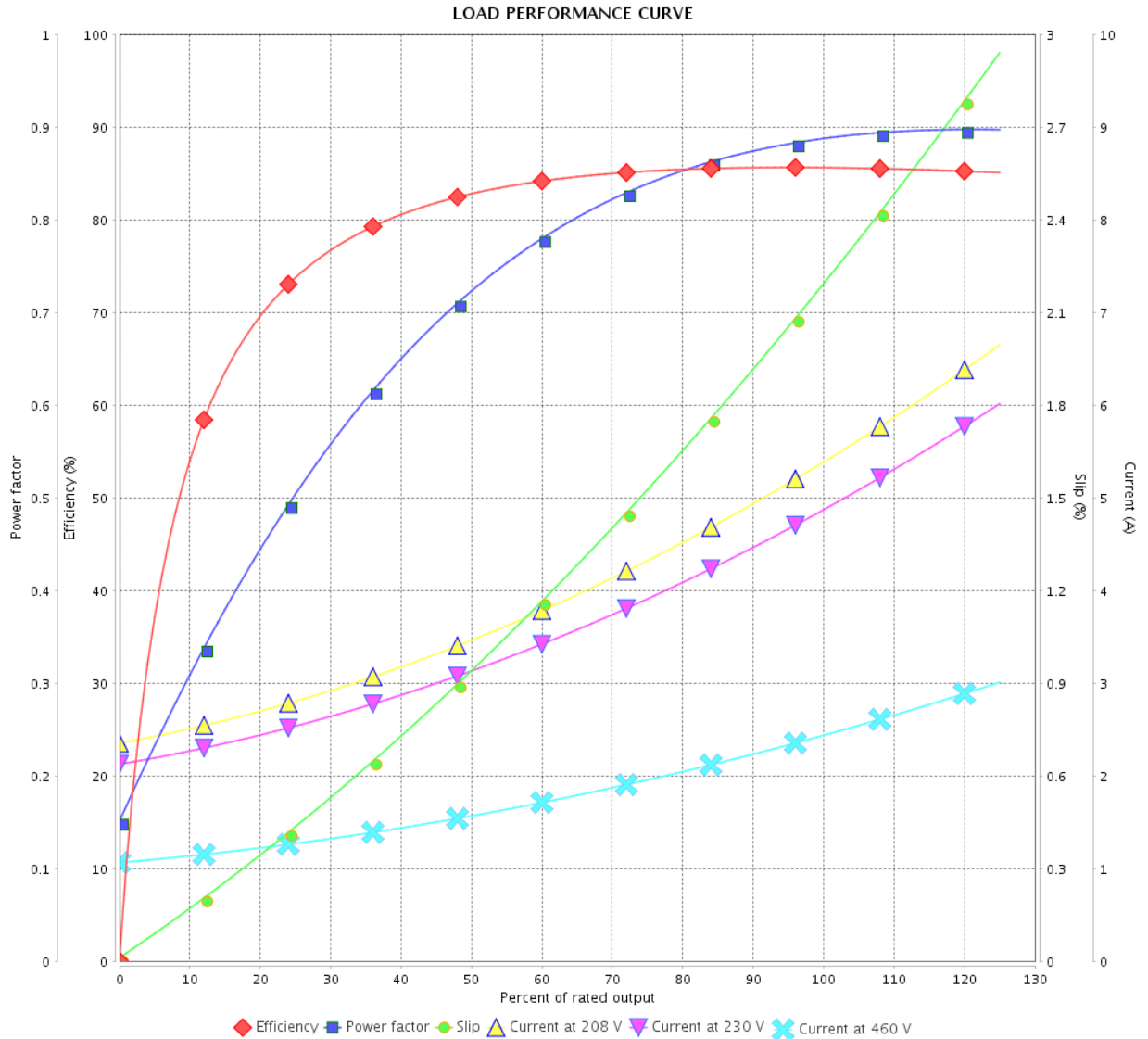

Performance : 230/460 V 60 Hz 2P

Rated current : 4.94/2.47 A  
 LRC : 9.9  
 Rated torque : 2.98 ft.lb  
 Locked rotor torque : 250 %  
 Breakdown torque : 300 %  
 Rated speed : 3520 rpm

Moment of inertia (J) : 0.1279 sq.ft.lb  
 Duty cycle : Cont.(S1)  
 Insulation class : F  
 Service factor :  
 Temperature rise : 80 K  
 Design : B

Rev.	Changes Summary	Performed	Checked	Date
Performed by			Page	Revision
Checked by				
Date				

# LOAD PERFORMANCE CURVE

Three Phase Induction Motor - Squirrel Cage



Customer : \_\_\_\_\_

Product line : Premium Efficiency Three-Phase      Product code : 14799195  
 Catalog # : 00236ET3E56C-S

LOAD PERFORMANCE CURVE

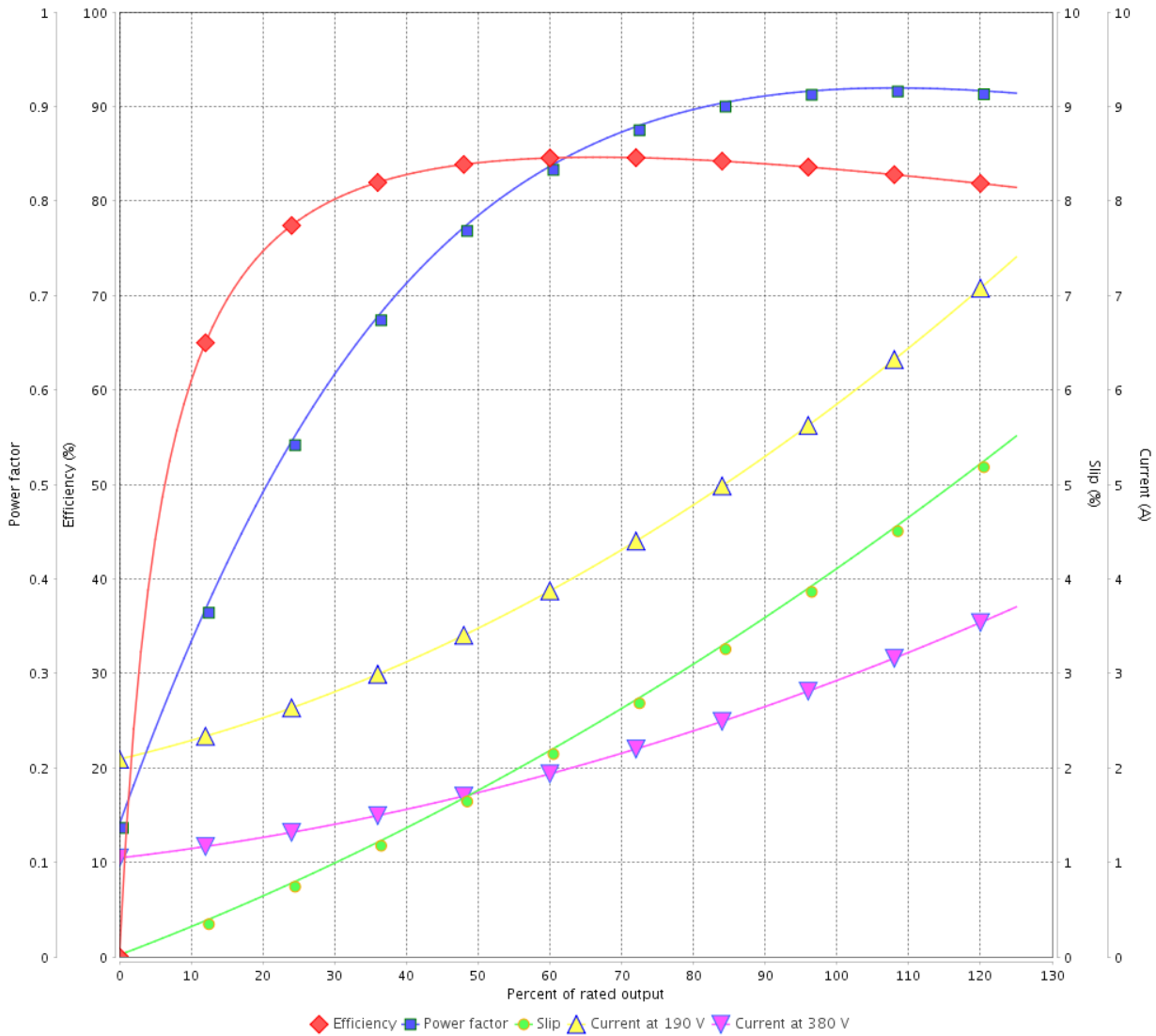

Performance : 190/380 V 50 Hz 2P

Rated current : 5.94/2.97 A  
 LRC : 7.4  
 Rated torque : 3.65 ft.lb  
 Locked rotor torque : 229 %  
 Breakdown torque : 280 %  
 Rated speed : 2875 rpm

Moment of inertia (J) : 0.1279 sq.ft.lb  
 Duty cycle : Cont.(S1)  
 Insulation class : F  
 Service factor : 1.15  
 Temperature rise : 80 K  
 Design : B

Rev.	Changes Summary	Performed	Checked	Date
Performed by			Page	Revision
Checked by				
Date				

# LOAD PERFORMANCE CURVE

## Three Phase Induction Motor - Squirrel Cage



Customer : \_\_\_\_\_

Product line : Premium Efficiency Three-Phase

Product code :

14799195

Catalog # :

00236ET3E56C-S

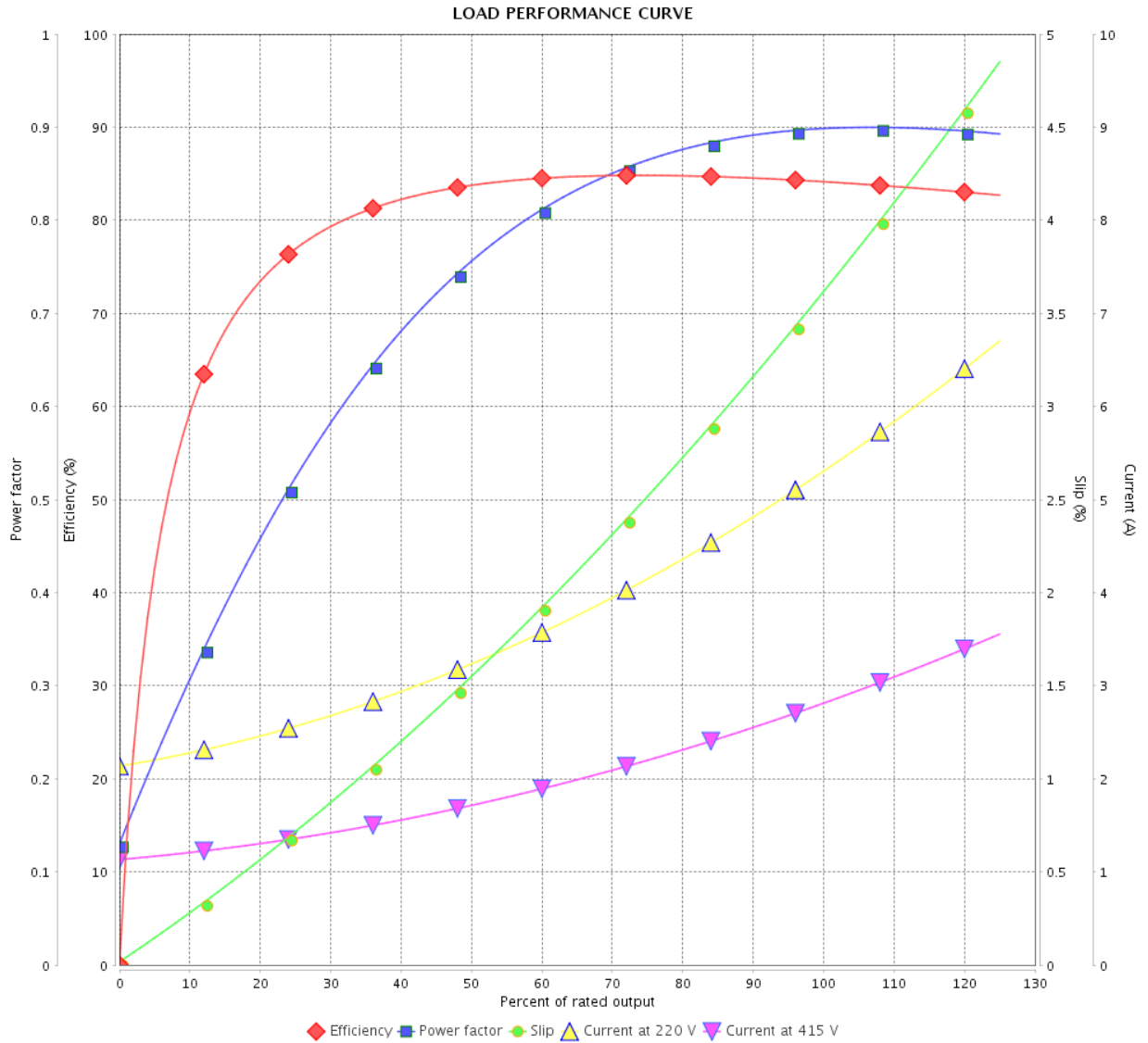

Performance : 220/415 V 50 Hz 2P

Rated current : 5.39/2.86 A  
 LRC : 8.2  
 Rated torque : 3.63 ft.lb  
 Locked rotor torque : 260 %  
 Breakdown torque : 310 %  
 Rated speed : 2890 rpm

Moment of inertia (J) : 0.1279 sq.ft.lb  
 Duty cycle : Cont.(S1)  
 Insulation class : F  
 Service factor : 1.15  
 Temperature rise : 80 K  
 Design : B

Rev.	Changes Summary	Performed	Checked	Date
Performed by			Page	Revision
Checked by				
Date				

# THERMAL LIMIT CURVE

## Three Phase Induction Motor - Squirrel Cage



Customer : \_\_\_\_\_

Product line : Premium Efficiency Three-Phase      Product code : 14799195  
 Catalog # : 00236ET3E56C-S

THERMAL LIMIT CURVE

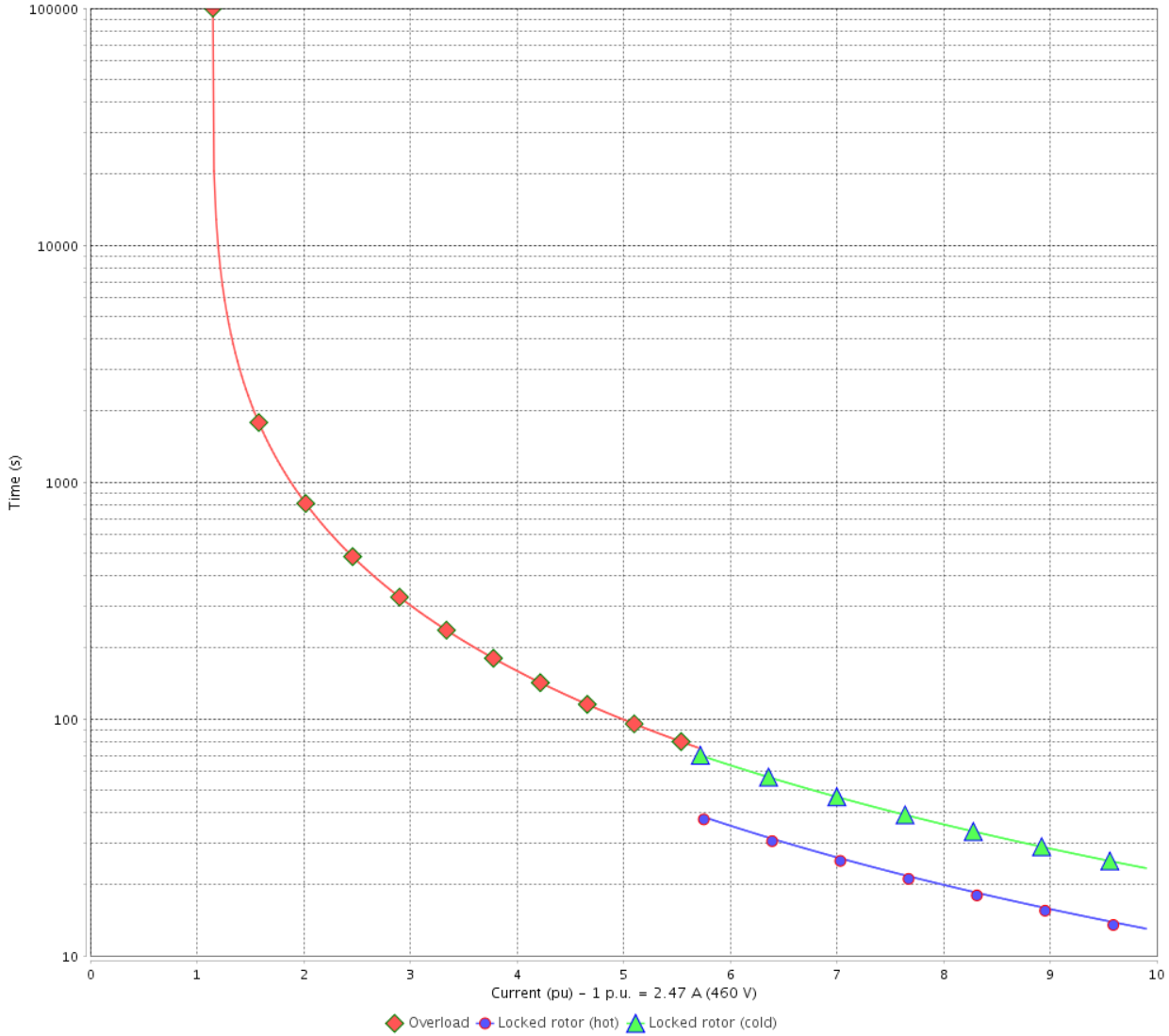

Performance : 230/460 V 60 Hz 2P

Rated current : 4.94/2.47 A  
 LRC : 9.9  
 Rated torque : 2.98 ft.lb  
 Locked rotor torque : 250 %  
 Breakdown torque : 300 %  
 Rated speed : 3520 rpm

Moment of inertia (J) : 0.1279 sq.ft.lb  
 Duty cycle : Cont.(S1)  
 Insulation class : F  
 Service factor :  
 Temperature rise : 80 K  
 Design : B

Heating constant

Cooling constant

Rev.	Changes Summary	Performed	Checked	Date
Performed by			Page	Revision
Checked by				
Date				



# THERMAL LIMIT CURVE

Three Phase Induction Motor - Squirrel Cage



Customer : \_\_\_\_\_

Product line : Premium Efficiency Three-Phase

Product code :

14799195

Catalog # :

00236ET3E56C-S

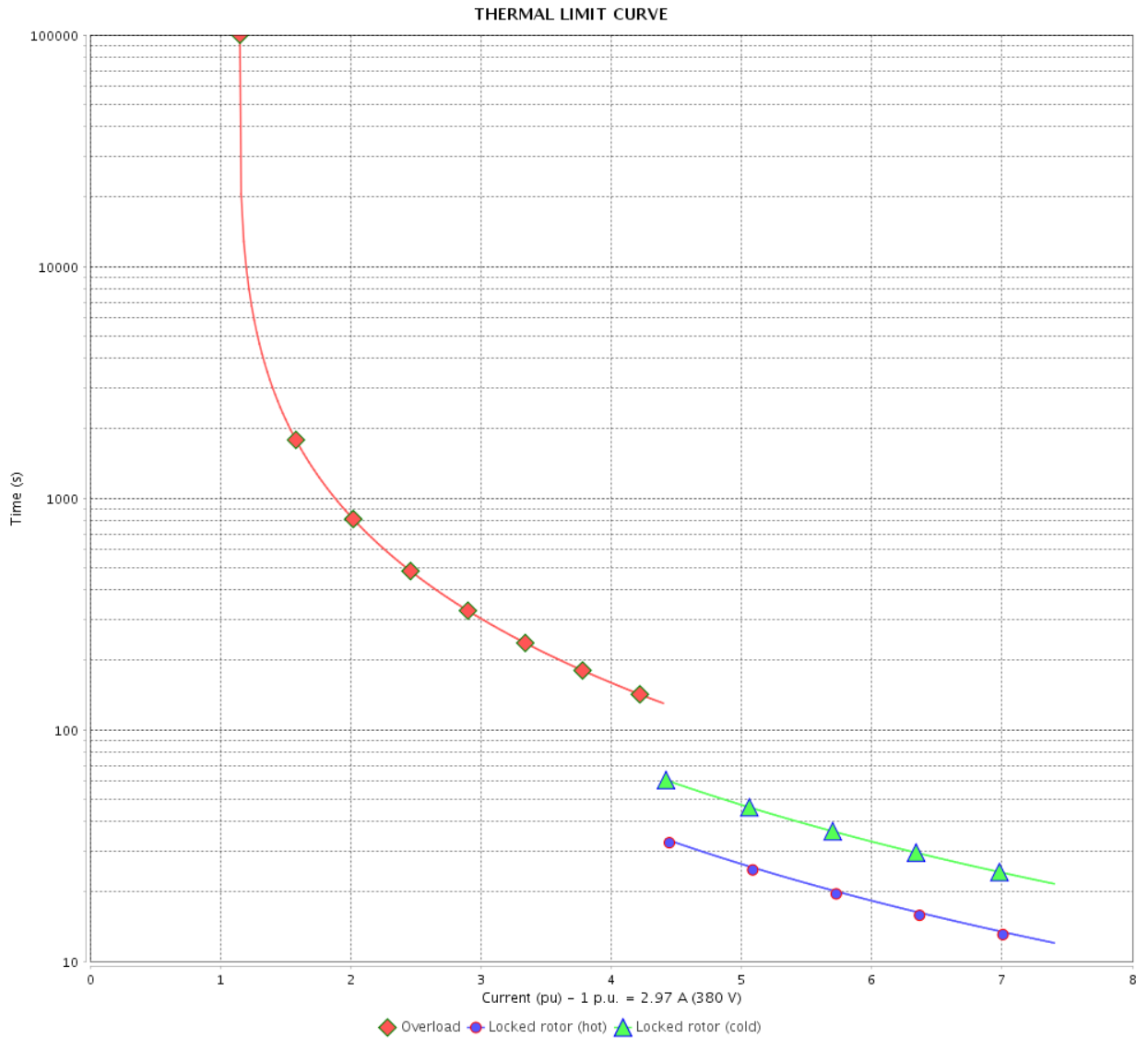

Performance : 190/380 V 50 Hz 2P

Rated current : 5.94/2.97 A  
 LRC : 7.4  
 Rated torque : 3.65 ft.lb  
 Locked rotor torque : 229 %  
 Breakdown torque : 280 %  
 Rated speed : 2875 rpm

Moment of inertia (J) : 0.1279 sq.ft.lb  
 Duty cycle : Cont.(S1)  
 Insulation class : F  
 Service factor : 1.15  
 Temperature rise : 80 K  
 Design : B

Heating constant

Cooling constant

Rev.	Changes Summary	Performed	Checked	Date
Performed by				
Checked by				
Date				
		Page	Revision	
		9 / 13		

# THERMAL LIMIT CURVE

Three Phase Induction Motor - Squirrel Cage



Customer :

Product line : Premium Efficiency Three-Phase      Product code : 14799195  
 Catalog # : 00236ET3E56C-S

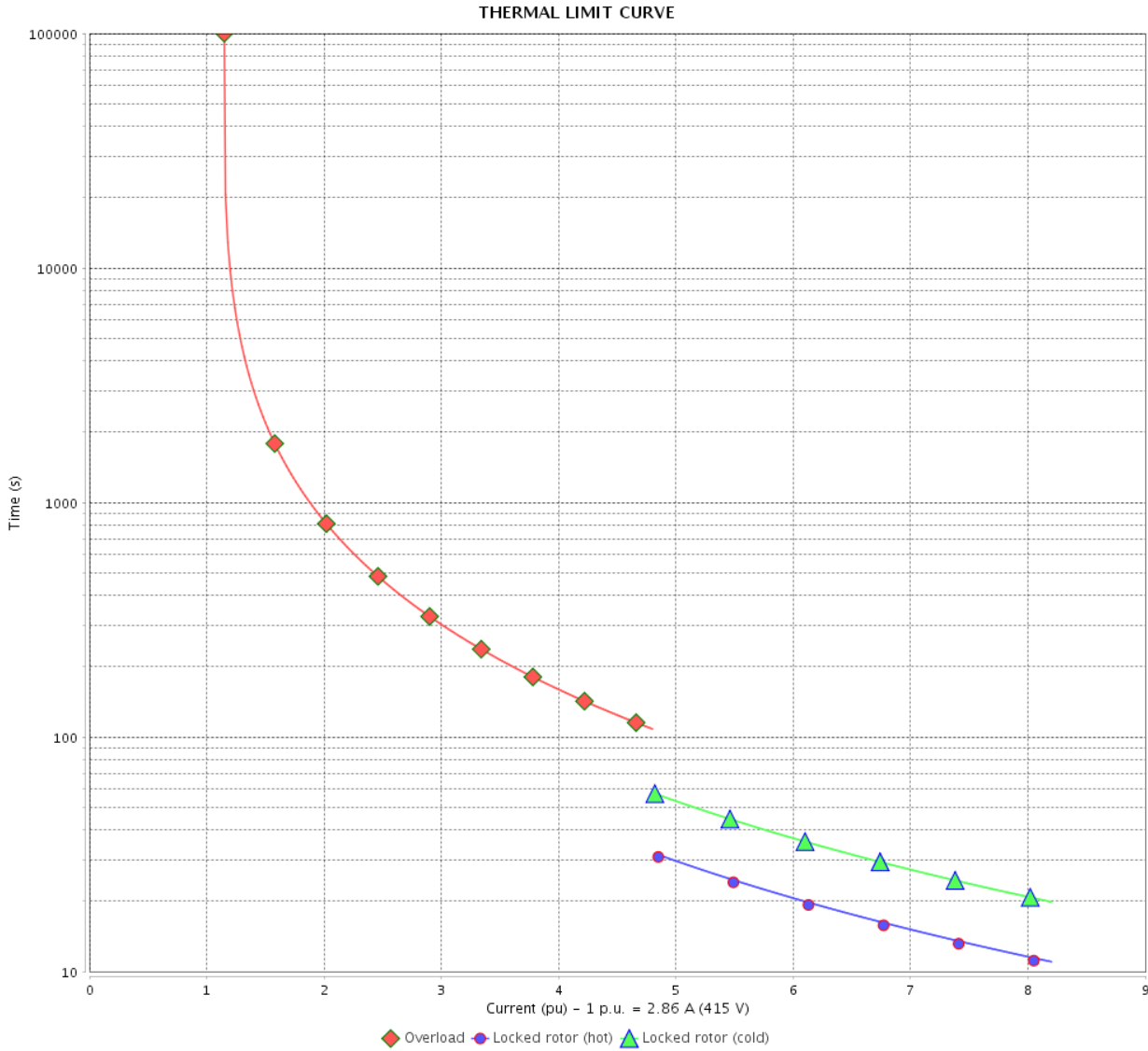

Performance : 220/415 V 50 Hz 2P

Rated current : 5.39/2.86 A  
 LRC : 8.2  
 Rated torque : 3.63 ft.lb  
 Locked rotor torque : 260 %  
 Breakdown torque : 310 %  
 Rated speed : 2890 rpm

Moment of inertia (J) : 0.1279 sq.ft.lb  
 Duty cycle : Cont.(S1)  
 Insulation class : F  
 Service factor : 1.15  
 Temperature rise : 80 K  
 Design : B

Heating constant

Cooling constant

Rev.	Changes Summary	Performed	Checked	Date
Performed by		Page		Revision
Checked by				
Date				
		10 / 13		

# VFD OPERATION CURVE

## Three Phase Induction Motor - Squirrel Cage



Customer : \_\_\_\_\_

Product line : Premium Efficiency Three-Phase

Product code :  
Catalog # :

14799195  
00236ET3E56C-S

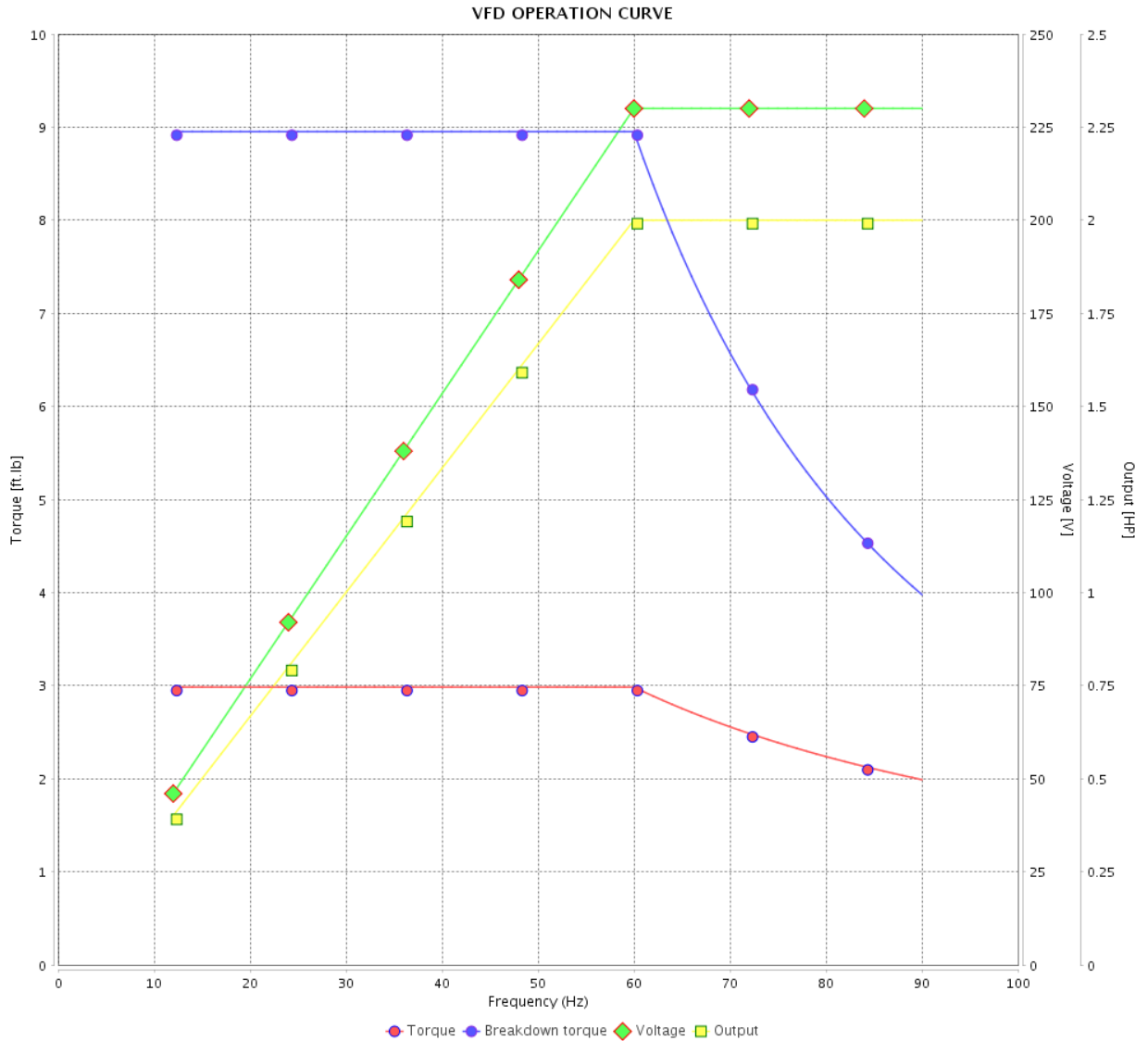

Performance : 230/460 V 60 Hz 2P

Rated current : 4.94/2.47 A  
 LRC : 9.9  
 Rated torque : 2.98 ft.lb  
 Locked rotor torque : 250 %  
 Breakdown torque : 300 %  
 Rated speed : 3520 rpm

Moment of inertia (J) : 0.1279 sq.ft.lb  
 Duty cycle : Cont.(S1)  
 Insulation class : F  
 Service factor :  
 Temperature rise : 80 K  
 Design : B

Rev.	Changes Summary	Performed	Checked	Date
Performed by			Page	Revision
Checked by				
Date				

# VFD OPERATION CURVE

Three Phase Induction Motor - Squirrel Cage



Customer : \_\_\_\_\_

Product line : Premium Efficiency Three-Phase      Product code : 14799195  
 Catalog # : 00236ET3E56C-S

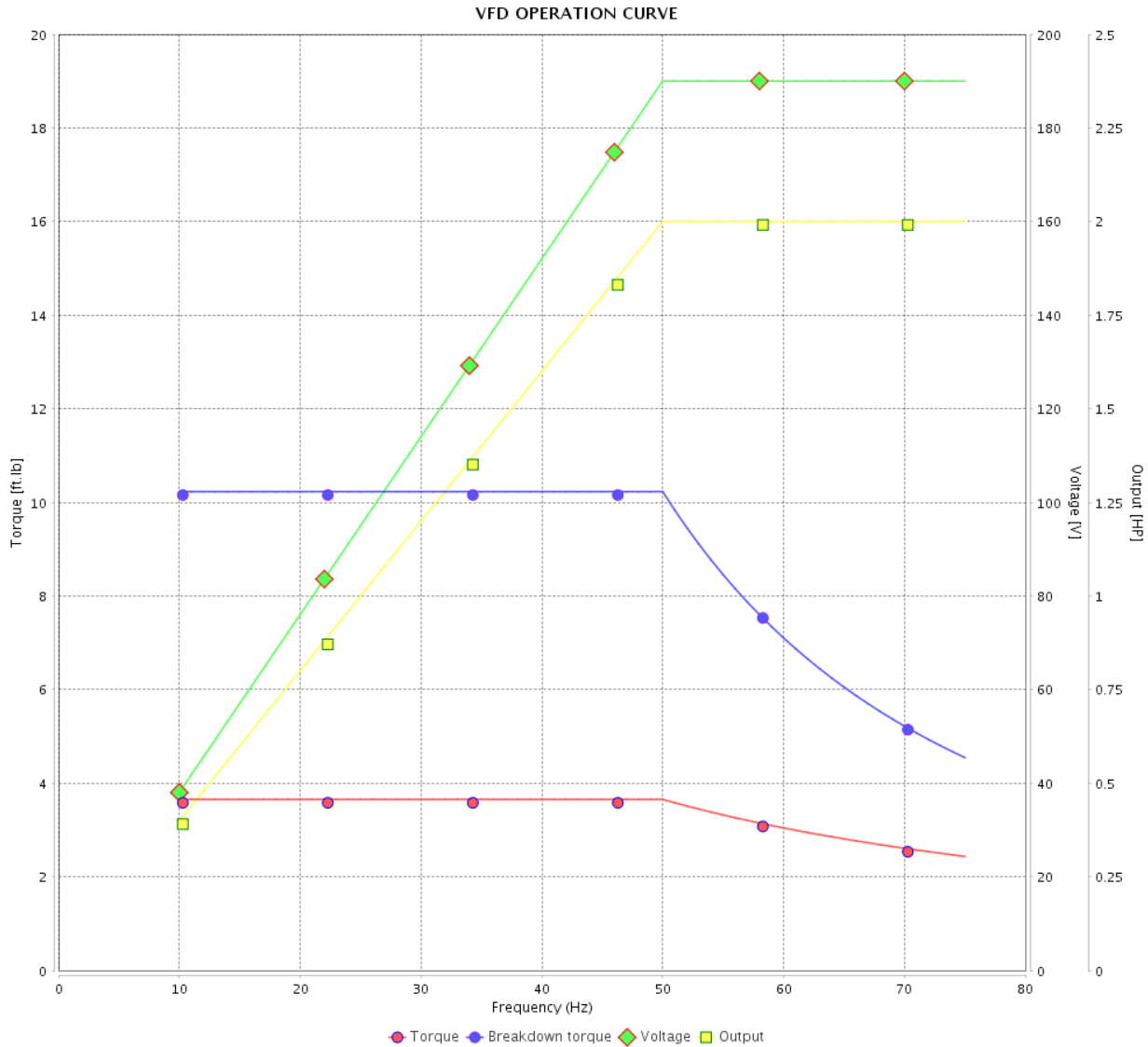

Performance : 190/380 V 50 Hz 2P

Rated current : 5.94/2.97 A  
 LRC : 7.4  
 Rated torque : 3.65 ft.lb  
 Locked rotor torque : 229 %  
 Breakdown torque : 280 %  
 Rated speed : 2875 rpm

Moment of inertia (J) : 0.1279 sq.ft.lb  
 Duty cycle : Cont.(S1)  
 Insulation class : F  
 Service factor : 1.15  
 Temperature rise : 80 K  
 Design : B

Rev.	Changes Summary	Performed	Checked	Date
Performed by			Page 12 / 13	Revision
Checked by				
Date	13/04/2022			

# VFD OPERATION CURVE

Three Phase Induction Motor - Squirrel Cage



Customer : \_\_\_\_\_

Product line : Premium Efficiency Three-Phase

Product code :

14799195

Catalog # :

00236ET3E56C-S

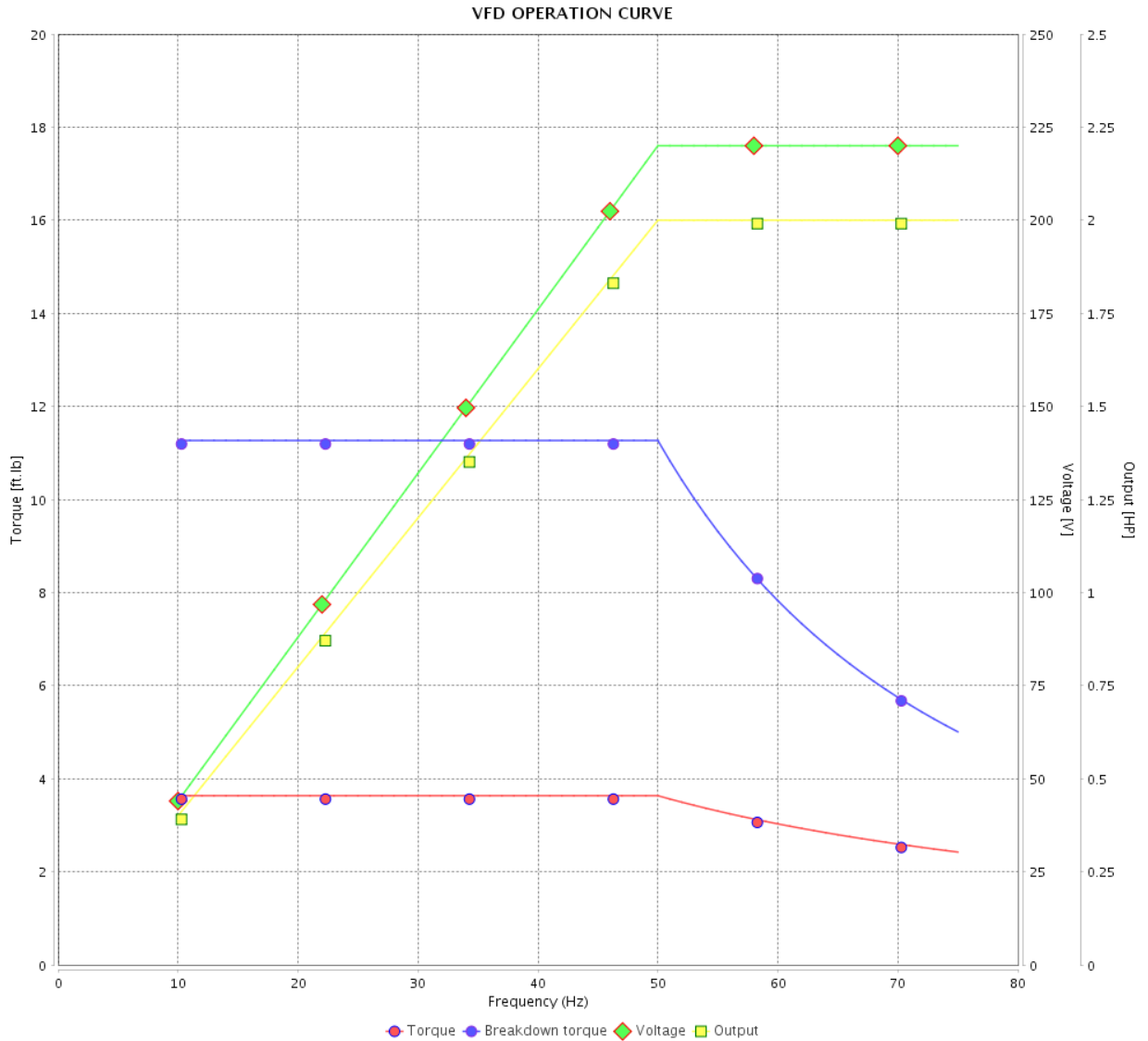

Performance : 220/415 V 50 Hz 2P

Rated current : 5.39/2.86 A  
 LRC : 8.2  
 Rated torque : 3.63 ft.lb  
 Locked rotor torque : 260 %  
 Breakdown torque : 310 %  
 Rated speed : 2890 rpm

Moment of inertia (J) : 0.1279 sq.ft.lb  
 Duty cycle : Cont.(S1)  
 Insulation class : F  
 Service factor : 1.15  
 Temperature rise : 80 K  
 Design : B

Rev.	Changes Summary	Performed	Checked	Date
Performed by			Page 13 / 13	Revision
Checked by				
Date	13/04/2022			

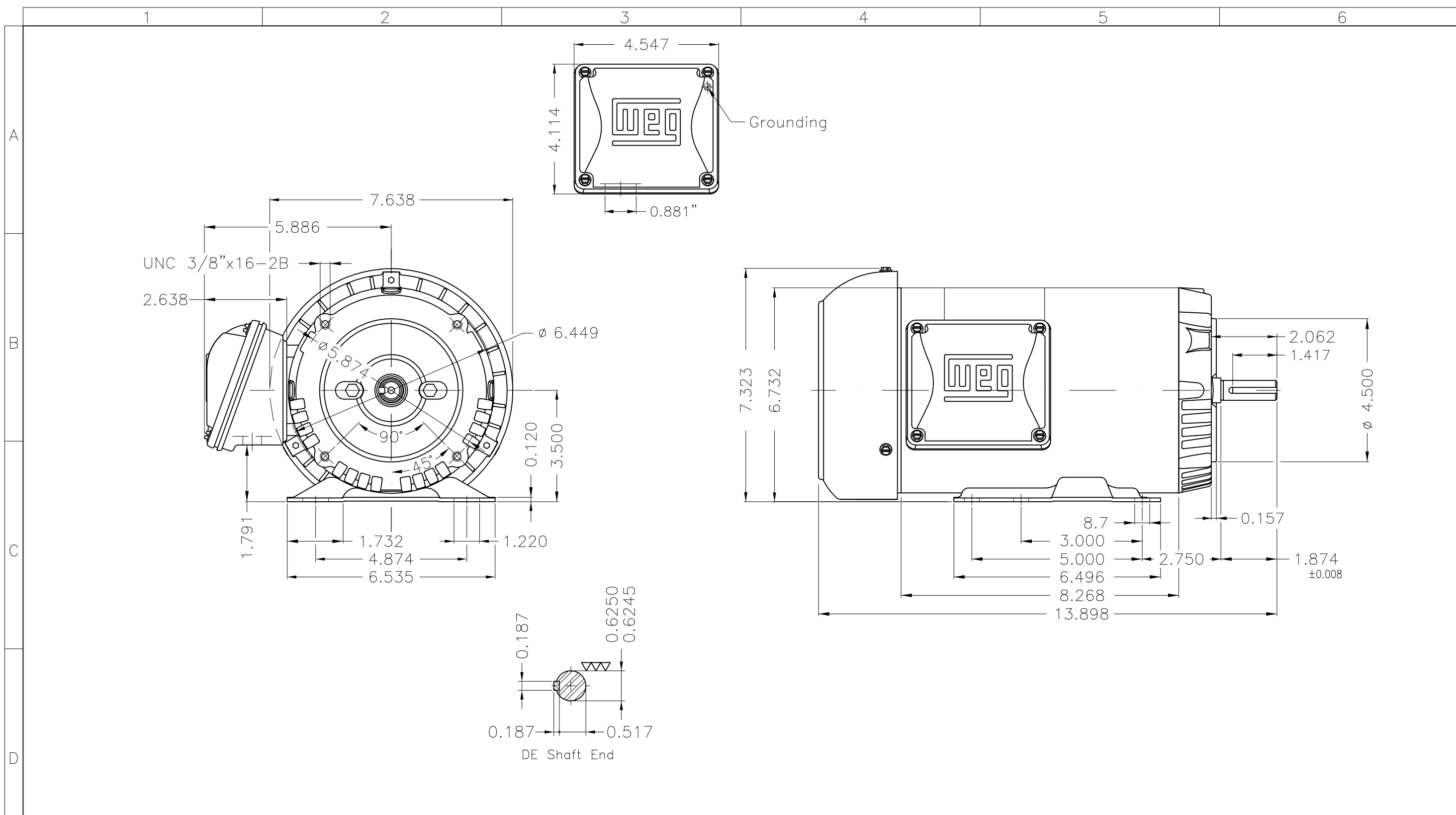

Fan cover - steel plate  
 Color Munsell N 1 matte black  
 Painting plan 207N  
 Mounting F-1/B34R(D)

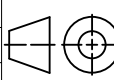
ECM	LOC	SUMMARY OF MODIFICATIONS	EXECUTED	CHECKED	RELEASED	DATE	VER
EXECUTED	PIRWBUSER	 THREE PH. MOTOR ROLLED STEEL PREM. EFF. FRAME 56HC IP55 TEFC					
CHECKED							
RELEASED							
REL DT.	WMO	Jaragua do Sul	Product Engineering	SHEET		1 / 1	

2 HP 02 Poles 60 Hz



Dimensions in inches XME A3

WEG's property. Forbidden reproduction without previous authorization.

**NEMA  
Premium**

®



3PT9

US LISTED



FOR SAFE AREA

Energy Verified

MADE IN BRAZIL

**MAT: 14799195 CC029A**  
**W01.TE0IC0X0X**  
**MODEL 00236ET3E56C-S**  
**08APR2022 B/N:**

**For 60Hz: Class I, Zone 2, IIC**  
**Class I, Div.2, Gr. A,B,C,D - T3**  
**Div 2 Inverter Duty (SF1.00)**  
**CT 2:1/VT 1000:1**

PH 3	Hz 60	HP 2.0
FR 56HC		KW 1.5
DUTY CONT.		V 230/460
ALT 1000 m.a.s.l.		A 4.94/2.47
INS CL F AT 80K	IP55	SFA 5.68/2.84
AMB 40°C	DES B	SF 1.15
ENCL TEFC	CODE L	PF 0.89
USABLE @ 208V 5.46A		RPM 3520
SF1.00		NEMA NOM. EFF 85.5%

**ALTERNATE RATING: 2.0HP 50Hz 190-220/380-415V SF1.15**  
**5.94-5.23/2.97-2.77A 2875RPM EFF 83.3% (IE2) IEC 60034-1**

For safe area-inverter duty motor For 60Hz use on VPWM 1000:1 VT, 5:1 CT

DE 6204-ZZ ODE 6202-ZZ MOBIL POLYREX EM



T1-BLU T2-WHT  
 T3-ORG T4-YEL  
 T5-BLK T6-GRY  
 T7-PNK T8-RED  
 T9-BRK RED

INTERCHANGE ANY TWO LINE WIRES TO REVERSE THE ROTATION

**WARNING:** Motor must be grounded in accordance with local and national electrical codes to prevent serious electrical shocks. Disconnect power source before servicing unit.



**AVERTISSEMENT:** Le moteur doit être mis à la terre conformément aux codes électriques locaux et nationaux afin d'éviter tout choc électrique grave. Déconnectez l'alimentation avant l'entretien de la machine.

