

DATA SHEET

Three Phase Induction Motor - Squirrel Cage



Customer :							
Product line	: NEMA Premium Efficiency Three-Phase	Product code :	12378662				
		Catalog # :	00336ET3E182T-W22				
Frame	: 182/4T	Cooling method	: IC411 - TEFC				
Insulation class	: F	Mounting	: F-1				
Duty cycle	: Cont.(S1)	Rotation ¹	: Both (CW and CCW)				
Ambient temperature	: -20°C to +40°C	Starting method	: Direct On Line				
Altitude	: 1000 m.a.s.l.	Approx. weight ²	: 86.5 lb				
Protection degree	: IP55	Moment of inertia (J)	: 0.1889 sq.ft.lb				
Design	: B						
Output [HP]	3	2	2	2	3	3	3
Poles	2	2	2	2	2	2	2
Frequency [Hz]	60	50	50	50	50	50	50
Rated voltage [V]	230/460	380	400	415	380	400	415
Rated current [A]	7.26/3.63	3.09	3.00	2.96	4.34	4.17	4.02
L. R. Amperes [A]	62.4/31.2	29.7	32.1	32.9	29.5	31.7	32.6
LRC [A]	8.6x(Code K)	9.6x(Code L)	10.7x(Code M)	11.1x(Code N)	6.8x(Code H)	7.6x(Code J)	8.1x(Code J)
No load current [A]	2.60/1.30	1.15	1.20	1.30	1.25	1.35	1.30
Rated speed [RPM]	3515	2930	2940	2945	2885	2900	2910
Slip [%]	2.36	2.33	2.00	1.83	3.83	3.33	3.00
Rated torque [ft.lb]	4.48	3.58	3.57	3.57	5.46	5.43	5.41
Locked rotor torque [%]	220	240	280	320	180	200	220
Breakdown torque [%]	340	380	440	459	250	280	310
Service factor	1.25	1.25	1.25	1.25	1.25	1.25	1.25
Temperature rise	80 K	80 K	80 K	80 K	80 K	80 K	80 K
Locked rotor time	54s (cold) 30s (hot)	68s (cold) 38s (hot)	63s (cold) 35s (hot)	57s (cold) 32s (hot)	55s (cold) 31s (hot)	52s (cold) 29s (hot)	48s (cold) 27s (hot)
Noise level ²	66.0 dB(A)	62.0 dB(A)	62.0 dB(A)	62.0 dB(A)	62.0 dB(A)	62.0 dB(A)	62.0 dB(A)
Efficiency (%)	25%						
	50%	82.5	81.0	80.6	79.7	84.0	84.0
	75%	86.5	84.5	84.5	84.1	86.5	86.5
	100%	86.5	85.8	85.8	85.9	85.5	86.5
Power Factor	25%						
	50%	0.75	0.68	0.65	0.63	0.80	0.77
	75%	0.84	0.79	0.77	0.75	0.87	0.86
	100%	0.88	0.86	0.84	0.82	0.90	0.89
Bearing type	: Drive end : 6207 ZZ	Non drive end : 6206 ZZ	Foundation loads				
Sealing	: V'Ring	V'Ring	Max. traction	: 64 lb			
Lubrication interval	: -	-	Max. compression	: 150 lb			
Lubricant amount	: -	-					
Lubricant type	: Mobil Polyrex EM						
Notes USABLE @208V 8.01A SF 1.15 SFA 9.21A							
This revision replaces and cancel the previous one, which must be eliminated. (1) Looking the motor from the shaft end. (2) Measured at 1m and with tolerance of +3dB(A). (3) Approximate weight subject to changes after manufacturing process. (4) At 100% of full load.				These are average values based on tests with sinusoidal power supply, subject to the tolerances stipulated in NEMA MG-1.			
Rev.	Changes Summary			Performed	Checked	Date	
Performed by							
Checked by					Page	Revision	
Date	13/04/2022				1 / 36		

TORQUE AND CURRENT VS SPEED CURVE

Three Phase Induction Motor - Squirrel Cage



Customer :

Product line : NEMA Premium Efficiency Three-Phase

Product code : 12378662

Catalog # : 00336ET3E182T-W22

TORQUE AND CURRENT VS SPEED CURVE

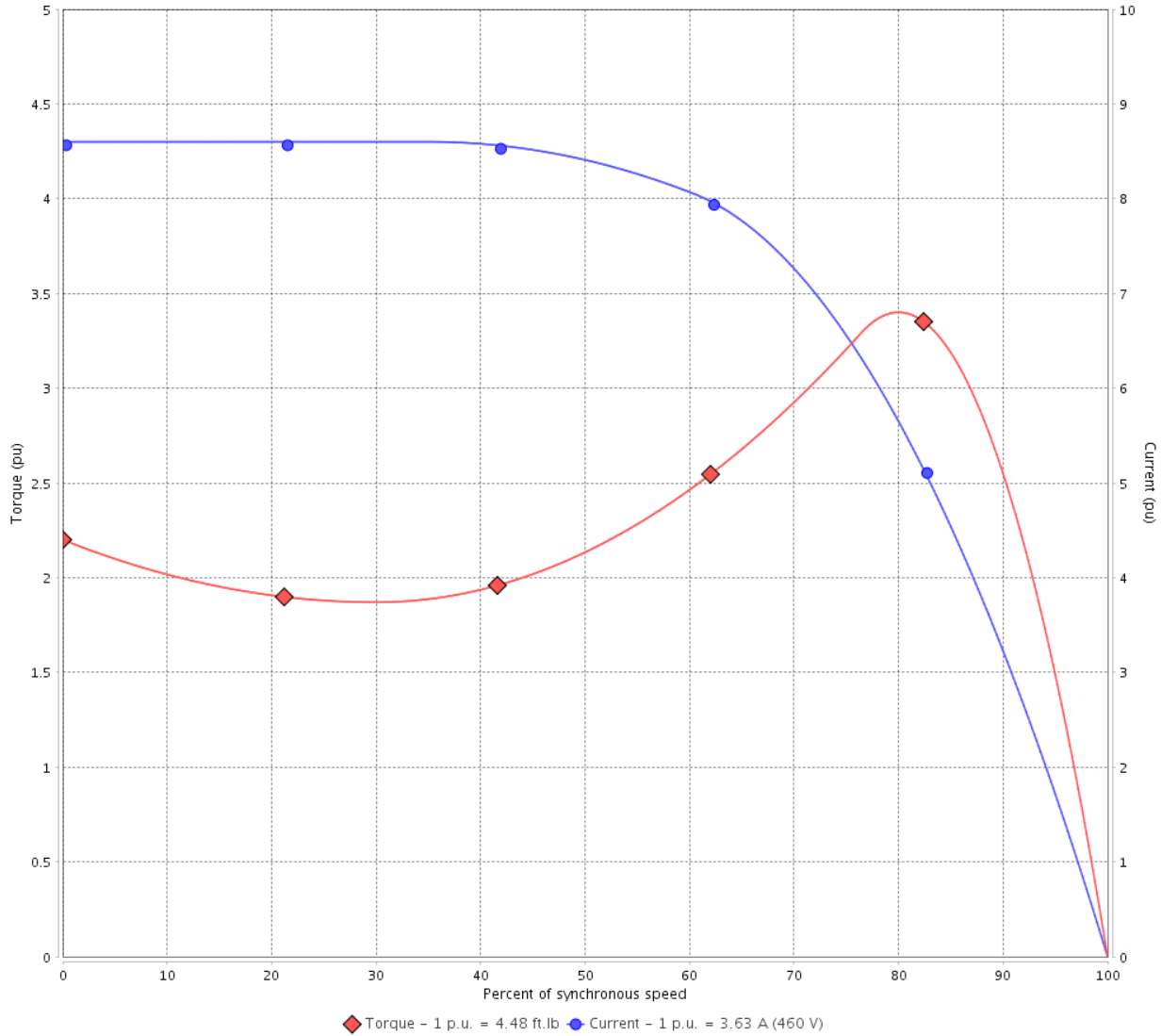

Performance : 230/460 V 60 Hz 2P

Rated current	: 7.26/3.63 A	Moment of inertia (J)	: 0.1889 sq.ft.lb
LRC	: 8.6	Duty cycle	: Cont.(S1)
Rated torque	: 4.48 ft.lb	Insulation class	: F
Locked rotor torque	: 220 %	Service factor	: 1.25
Breakdown torque	: 340 %	Temperature rise	: 80 K
Rated speed	: 3515 rpm	Design	: B

Locked rotor time : 54s (cold) 30s (hot)

Rev.	Changes Summary	Performed	Checked	Date
Performed by			Page 2 / 36	Revision
Checked by				
Date	13/04/2022			

TORQUE AND CURRENT VS SPEED CURVE



Three Phase Induction Motor - Squirrel Cage

Customer :

Product line : NEMA Premium Efficiency Three-Phase

Product code : 12378662

Catalog # : 00336ET3E182T-W22

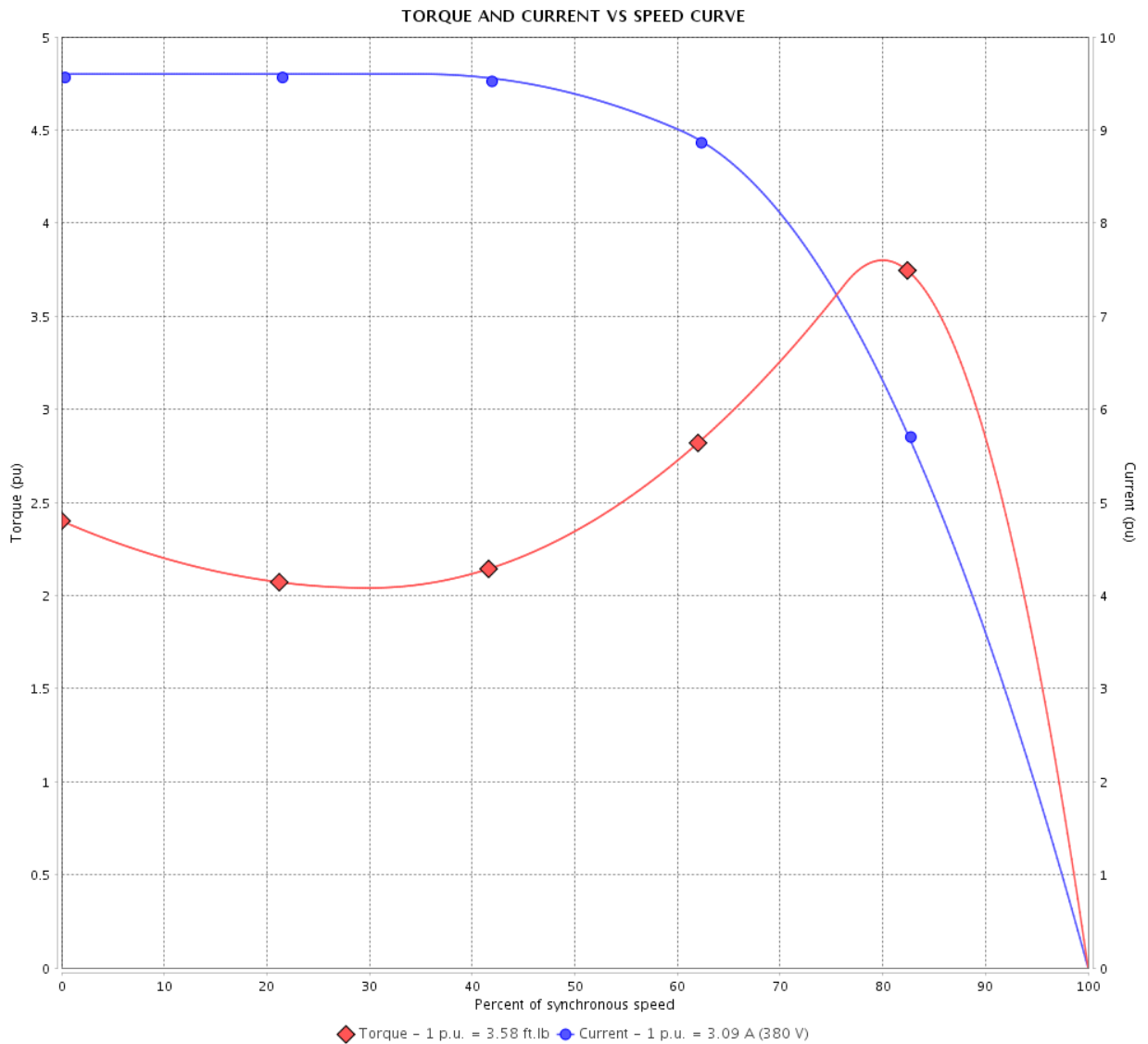

Performance : 380 V 50 Hz 2P IE3

Rated current : 3.09 A
 LRC : 9.6
 Rated torque : 3.58 ft.lb
 Locked rotor torque : 240 %
 Breakdown torque : 380 %
 Rated speed : 2930 rpm

Moment of inertia (J) : 0.1889 sq.ft.lb
 Duty cycle : Cont.(S1)
 Insulation class : F
 Service factor : 1.25
 Temperature rise : 80 K
 Design : B

Locked rotor time : 68s (cold) 38s (hot)

Rev.	Changes Summary	Performed	Checked	Date
Performed by			Page 3 / 36	Revision
Checked by				
Date	13/04/2022			

TORQUE AND CURRENT VS SPEED CURVE

Three Phase Induction Motor - Squirrel Cage



Customer :

Product line : NEMA Premium Efficiency Three-Phase

Product code : 12378662

Catalog # : 00336ET3E182T-W22

TORQUE AND CURRENT VS SPEED CURVE

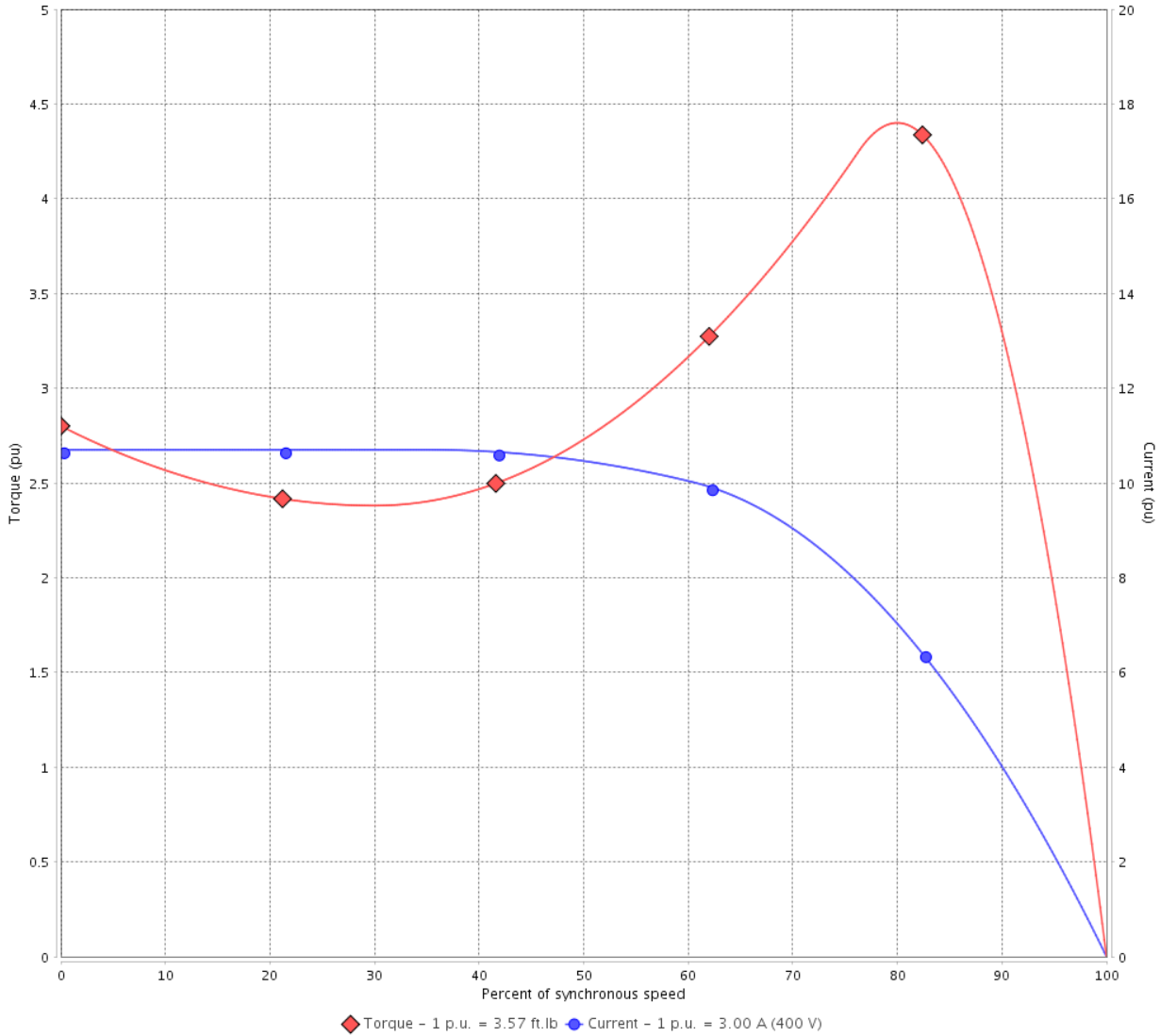

Performance : 400 V 50 Hz 2P IE3

Rated current	: 3.00 A	Moment of inertia (J)	: 0.1889 sq.ft.lb
LRC	: 10.7	Duty cycle	: Cont.(S1)
Rated torque	: 3.57 ft.lb	Insulation class	: F
Locked rotor torque	: 280 %	Service factor	: 1.25
Breakdown torque	: 440 %	Temperature rise	: 80 K
Rated speed	: 2940 rpm	Design	: B

Locked rotor time : 63s (cold) 35s (hot)

Rev.	Changes Summary	Performed	Checked	Date
Performed by			Page 4 / 36	Revision
Checked by				
Date	13/04/2022			

TORQUE AND CURRENT VS SPEED CURVE



Three Phase Induction Motor - Squirrel Cage

Customer :

Product line : NEMA Premium Efficiency Three-Phase

Product code : 12378662

Catalog # : 00336ET3E182T-W22

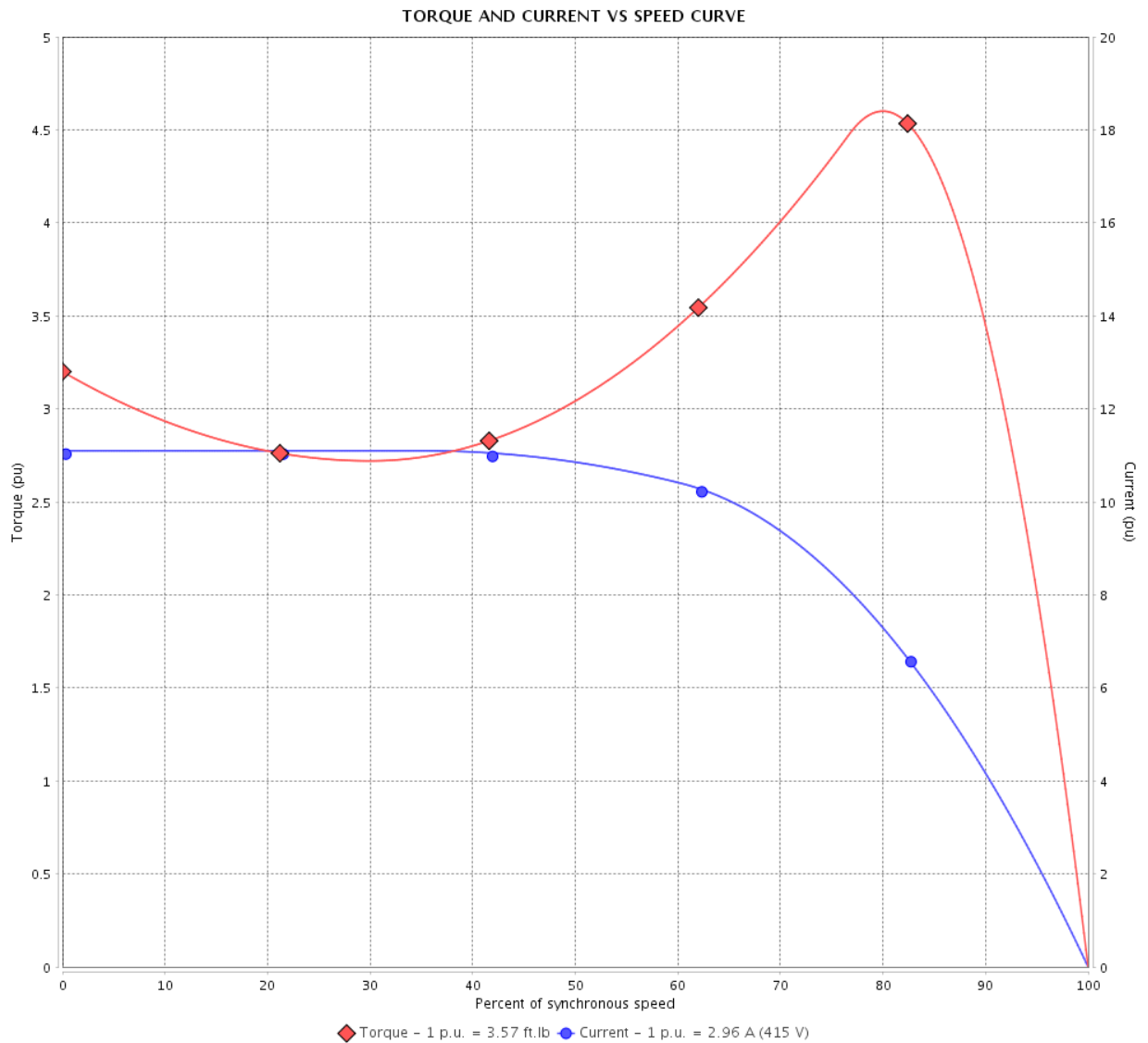

Performance : 415 V 50 Hz 2P IE3

Rated current : 2.96 A
 LRC : 11.1
 Rated torque : 3.57 ft.lb
 Locked rotor torque : 320 %
 Breakdown torque : 459 %
 Rated speed : 2945 rpm

Moment of inertia (J) : 0.1889 sq.ft.lb
 Duty cycle : Cont.(S1)
 Insulation class : F
 Service factor : 1.25
 Temperature rise : 80 K
 Design : B

Locked rotor time : 57s (cold) 32s (hot)

Rev.	Changes Summary	Performed	Checked	Date
Performed by			Page 5 / 36	Revision
Checked by				
Date	13/04/2022			

TORQUE AND CURRENT VS SPEED CURVE

Three Phase Induction Motor - Squirrel Cage



Customer :

Product line : NEMA Premium Efficiency Three-Phase

Product code : 12378662

Catalog # : 00336ET3E182T-W22

TORQUE AND CURRENT VS SPEED CURVE

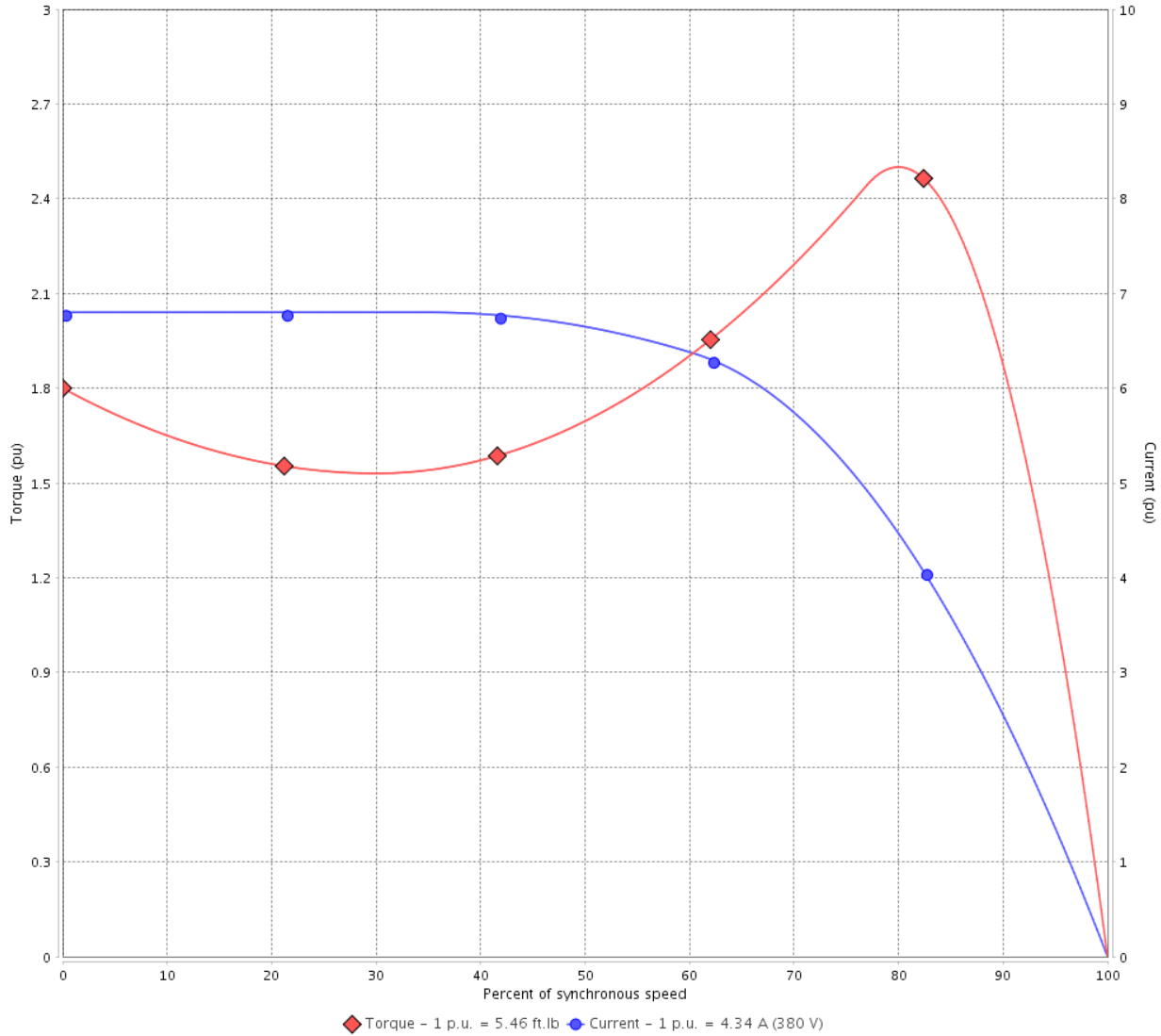

Performance : 380 V 50 Hz 2P IE2

Rated current	: 4.34 A	Moment of inertia (J)	: 0.1889 sq.ft.lb
LRC	: 6.8	Duty cycle	: Cont.(S1)
Rated torque	: 5.46 ft.lb	Insulation class	: F
Locked rotor torque	: 180 %	Service factor	: 1.25
Breakdown torque	: 250 %	Temperature rise	: 80 K
Rated speed	: 2885 rpm	Design	: B

Locked rotor time : 55s (cold) 31s (hot)

Rev.	Changes Summary	Performed	Checked	Date
Performed by			Page 6 / 36	Revision
Checked by				
Date	13/04/2022			

TORQUE AND CURRENT VS SPEED CURVE



Three Phase Induction Motor - Squirrel Cage

Customer :

Product line : NEMA Premium Efficiency Three-Phase

Product code : 12378662

Catalog # : 00336ET3E182T-W22

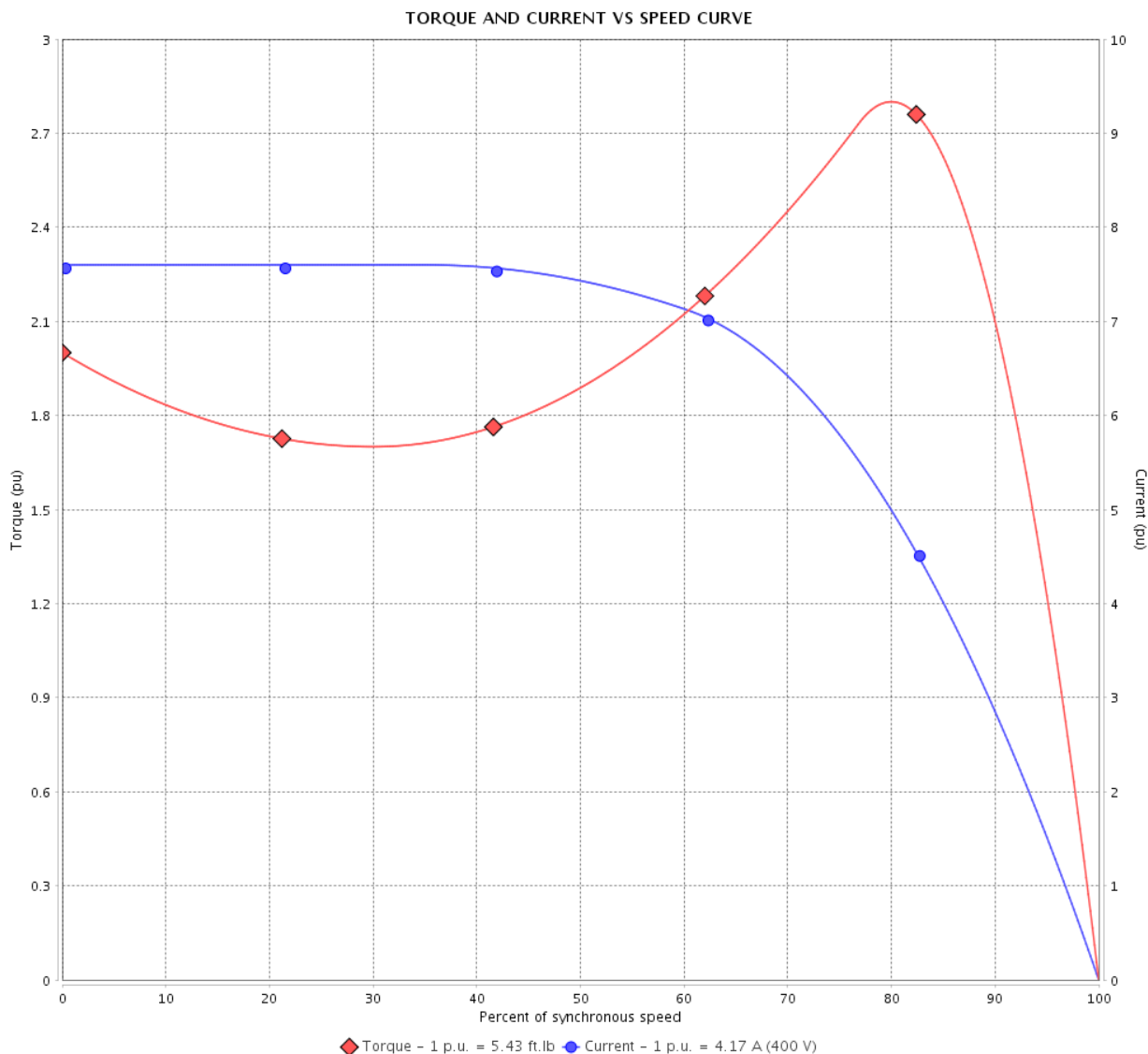

Performance : 400 V 50 Hz 2P IE2

Rated current	: 4.17 A	Moment of inertia (J)	: 0.1889 sq.ft.lb
LRC	: 7.6	Duty cycle	: Cont.(S1)
Rated torque	: 5.43 ft.lb	Insulation class	: F
Locked rotor torque	: 200 %	Service factor	: 1.25
Breakdown torque	: 280 %	Temperature rise	: 80 K
Rated speed	: 2900 rpm	Design	: B

Locked rotor time : 52s (cold) 29s (hot)

Rev.	Changes Summary	Performed	Checked	Date
Performed by			Page 7 / 36	Revision
Checked by				
Date	13/04/2022			

TORQUE AND CURRENT VS SPEED CURVE

Three Phase Induction Motor - Squirrel Cage



Customer :

Product line : NEMA Premium Efficiency Three-Phase

Product code : 12378662

Catalog # : 00336ET3E182T-W22

TORQUE AND CURRENT VS SPEED CURVE

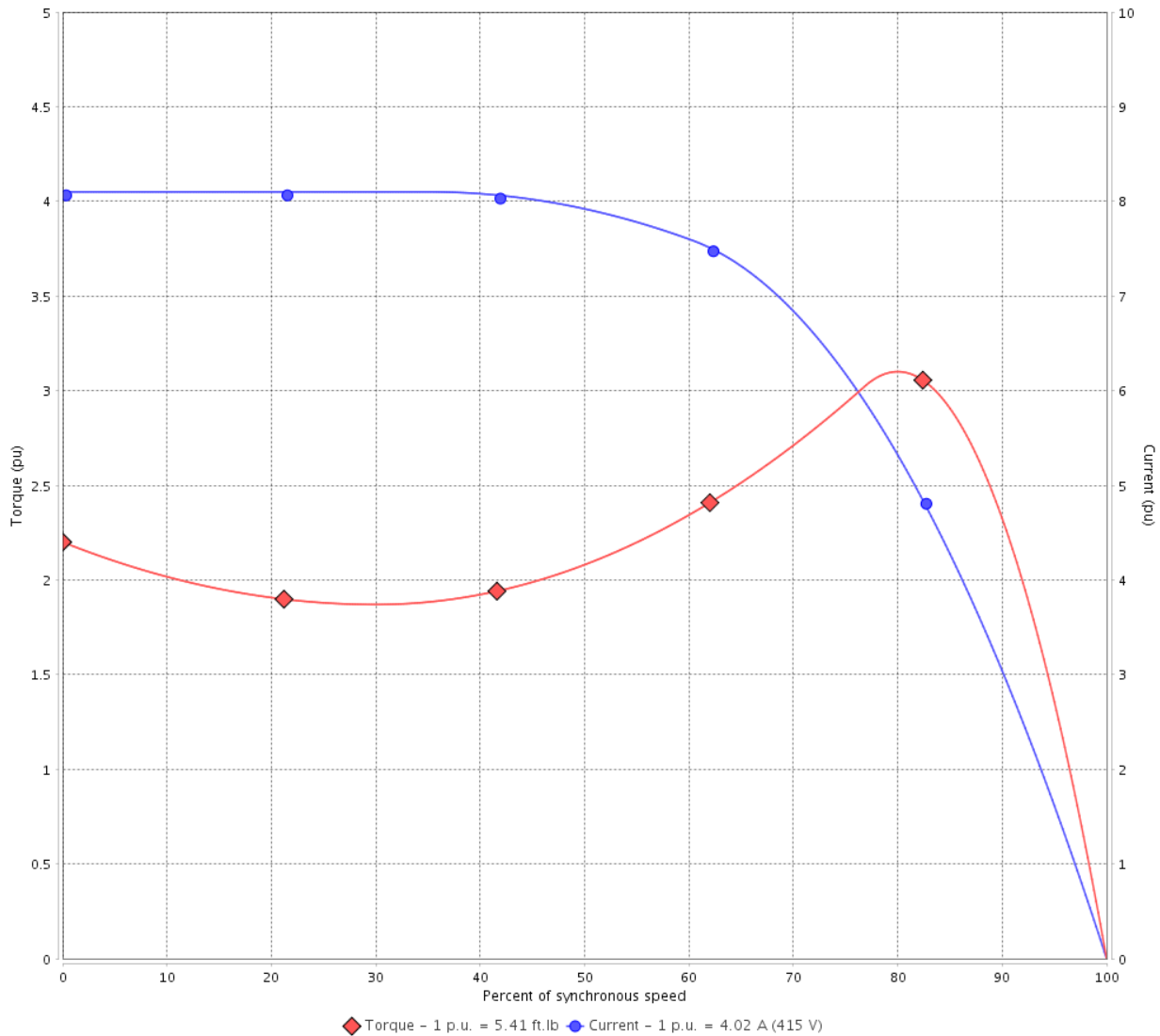

Performance : 415 V 50 Hz 2P IE3

Rated current	: 4.02 A	Moment of inertia (J)	: 0.1889 sq.ft.lb
LRC	: 8.1	Duty cycle	: Cont.(S1)
Rated torque	: 5.41 ft.lb	Insulation class	: F
Locked rotor torque	: 220 %	Service factor	: 1.25
Breakdown torque	: 310 %	Temperature rise	: 80 K
Rated speed	: 2910 rpm	Design	: B

Locked rotor time : 48s (cold) 27s (hot)

Rev.	Changes Summary	Performed	Checked	Date
Performed by			Page 8 / 36	Revision
Checked by				
Date	13/04/2022			

LOAD PERFORMANCE CURVE

Three Phase Induction Motor - Squirrel Cage



Customer : _____

Product line : NEMA Premium Efficiency Three-Phase

Product code : 12378662

Catalog # : 00336ET3E182T-W22

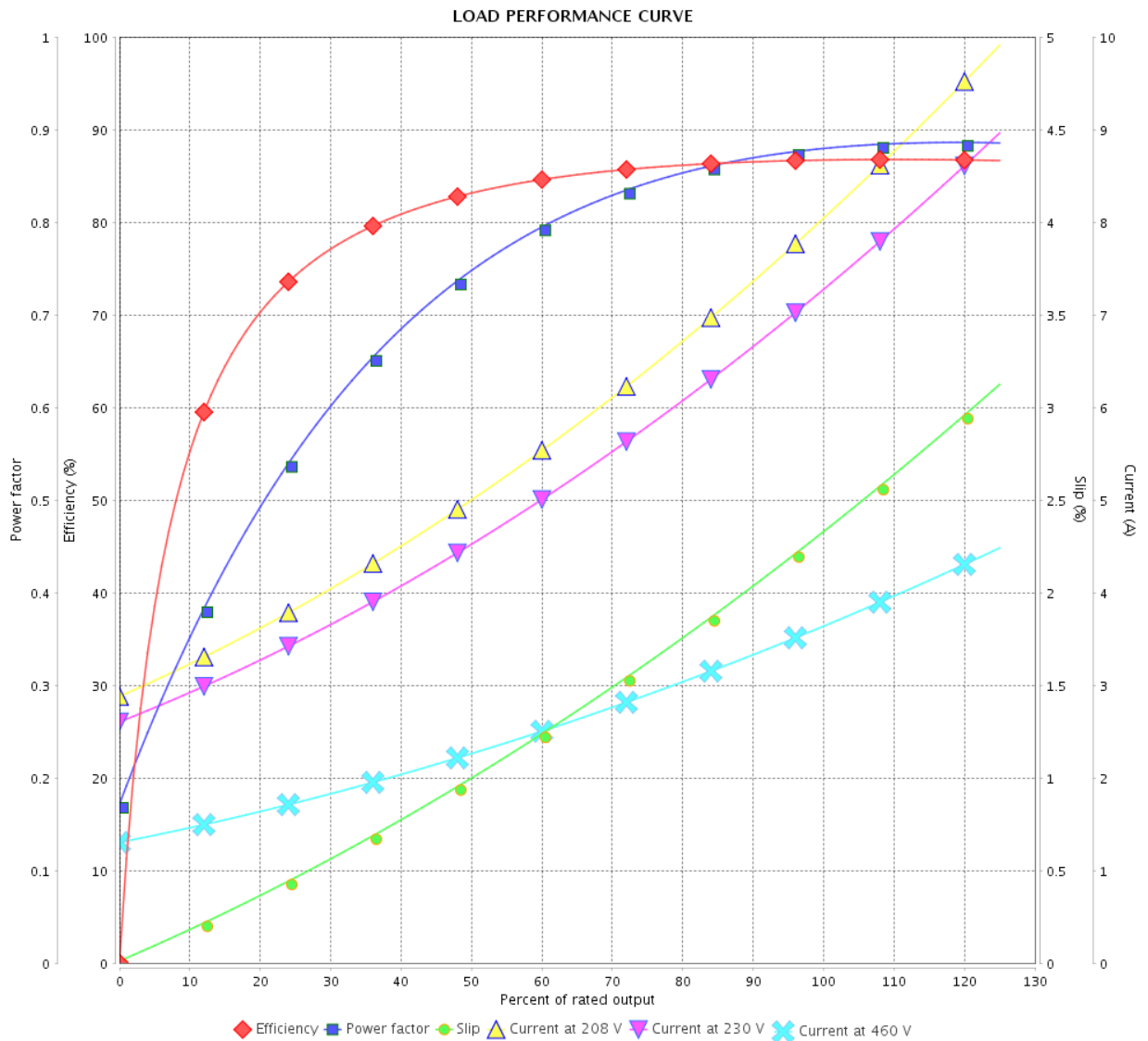

Performance : 230/460 V 60 Hz 2P

Rated current : 7.26/3.63 A
 LRC : 8.6
 Rated torque : 4.48 ft.lb
 Locked rotor torque : 220 %
 Breakdown torque : 340 %
 Rated speed : 3515 rpm

Moment of inertia (J) : 0.1889 sq.ft.lb
 Duty cycle : Cont.(S1)
 Insulation class : F
 Service factor : 1.25
 Temperature rise : 80 K
 Design : B

Rev.	Changes Summary	Performed	Checked	Date
Performed by			Page	Revision
Checked by				
Date				

LOAD PERFORMANCE CURVE

Three Phase Induction Motor - Squirrel Cage



Customer :

Product line : NEMA Premium Efficiency Three-Phase

Product code : 12378662

Catalog # : 00336ET3E182T-W22

LOAD PERFORMANCE CURVE

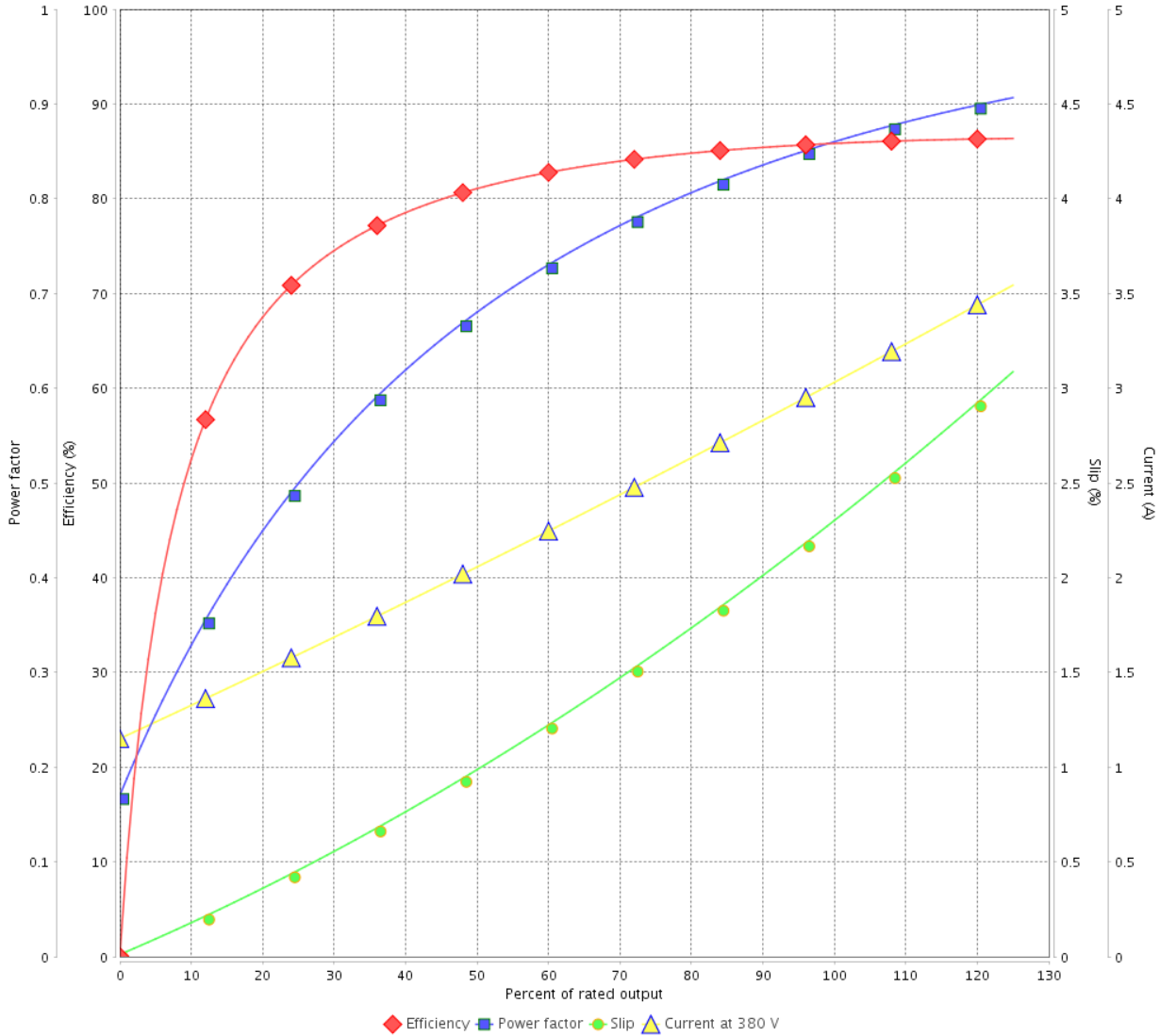

Performance : 380 V 50 Hz 2P IE3

Rated current : 3.09 A
 LRC : 9.6
 Rated torque : 3.58 ft.lb
 Locked rotor torque : 240 %
 Breakdown torque : 380 %
 Rated speed : 2930 rpm

Moment of inertia (J) : 0.1889 sq.ft.lb
 Duty cycle : Cont.(S1)
 Insulation class : F
 Service factor : 1.25
 Temperature rise : 80 K
 Design : B

Rev.	Changes Summary	Performed	Checked	Date
Performed by			Page 10 / 36	Revision
Checked by				
Date	13/04/2022			

LOAD PERFORMANCE CURVE

Three Phase Induction Motor - Squirrel Cage



Customer :

Product line : NEMA Premium Efficiency Three-Phase

Product code : 12378662

Catalog # : 00336ET3E182T-W22

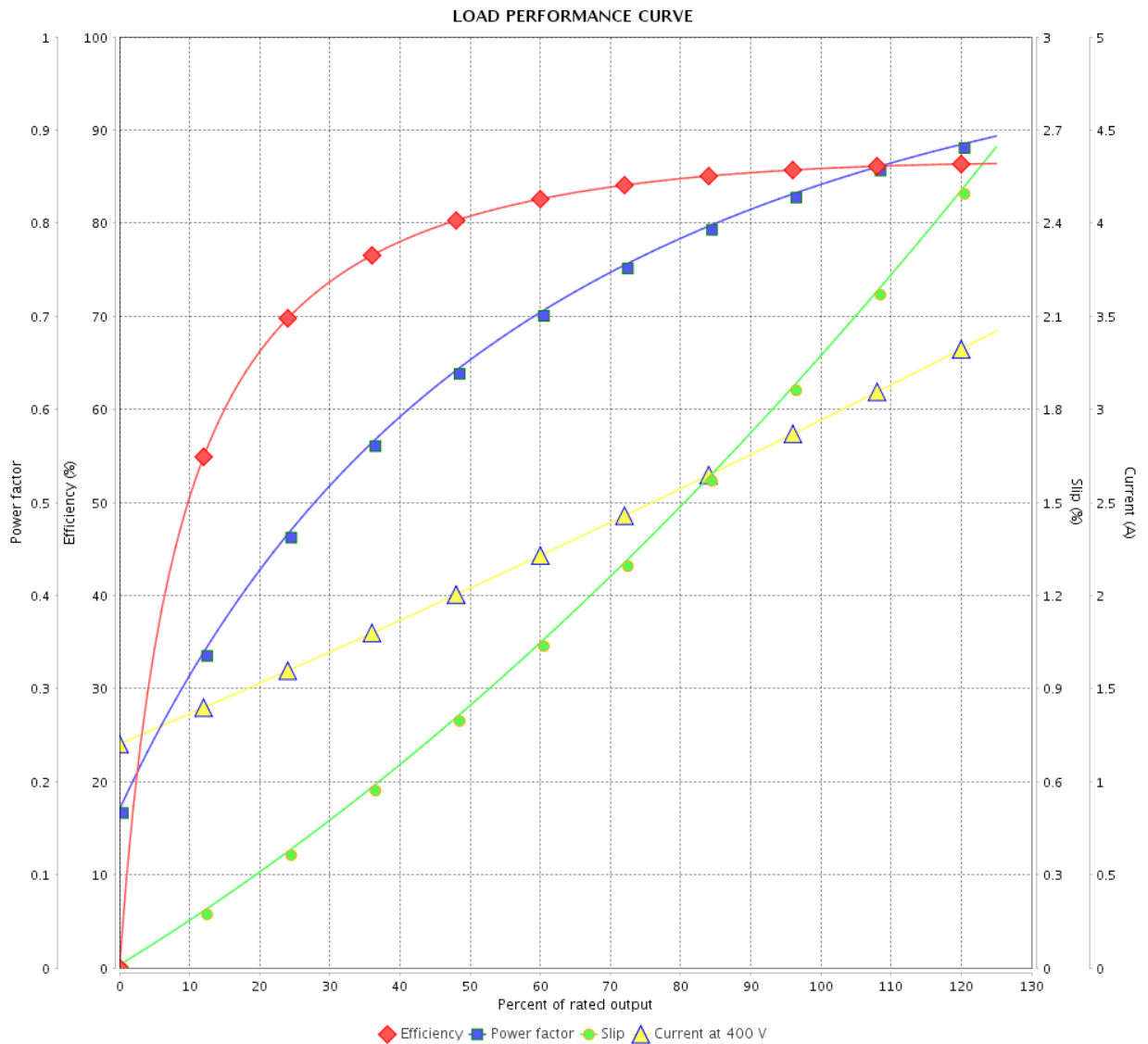

Performance : 400 V 50 Hz 2P IE3

Rated current : 3.00 A
 LRC : 10.7
 Rated torque : 3.57 ft.lb
 Locked rotor torque : 280 %
 Breakdown torque : 440 %
 Rated speed : 2940 rpm

Moment of inertia (J) : 0.1889 sq.ft.lb
 Duty cycle : Cont.(S1)
 Insulation class : F
 Service factor : 1.25
 Temperature rise : 80 K
 Design : B

Rev.	Changes Summary	Performed	Checked	Date
Performed by		Page		Revision
Checked by		11 / 36		
Date		13/04/2022		

LOAD PERFORMANCE CURVE

Three Phase Induction Motor - Squirrel Cage



Customer :

Product line : NEMA Premium Efficiency Three-Phase
 Product code : 12378662
 Catalog # : 00336ET3E182T-W22

LOAD PERFORMANCE CURVE

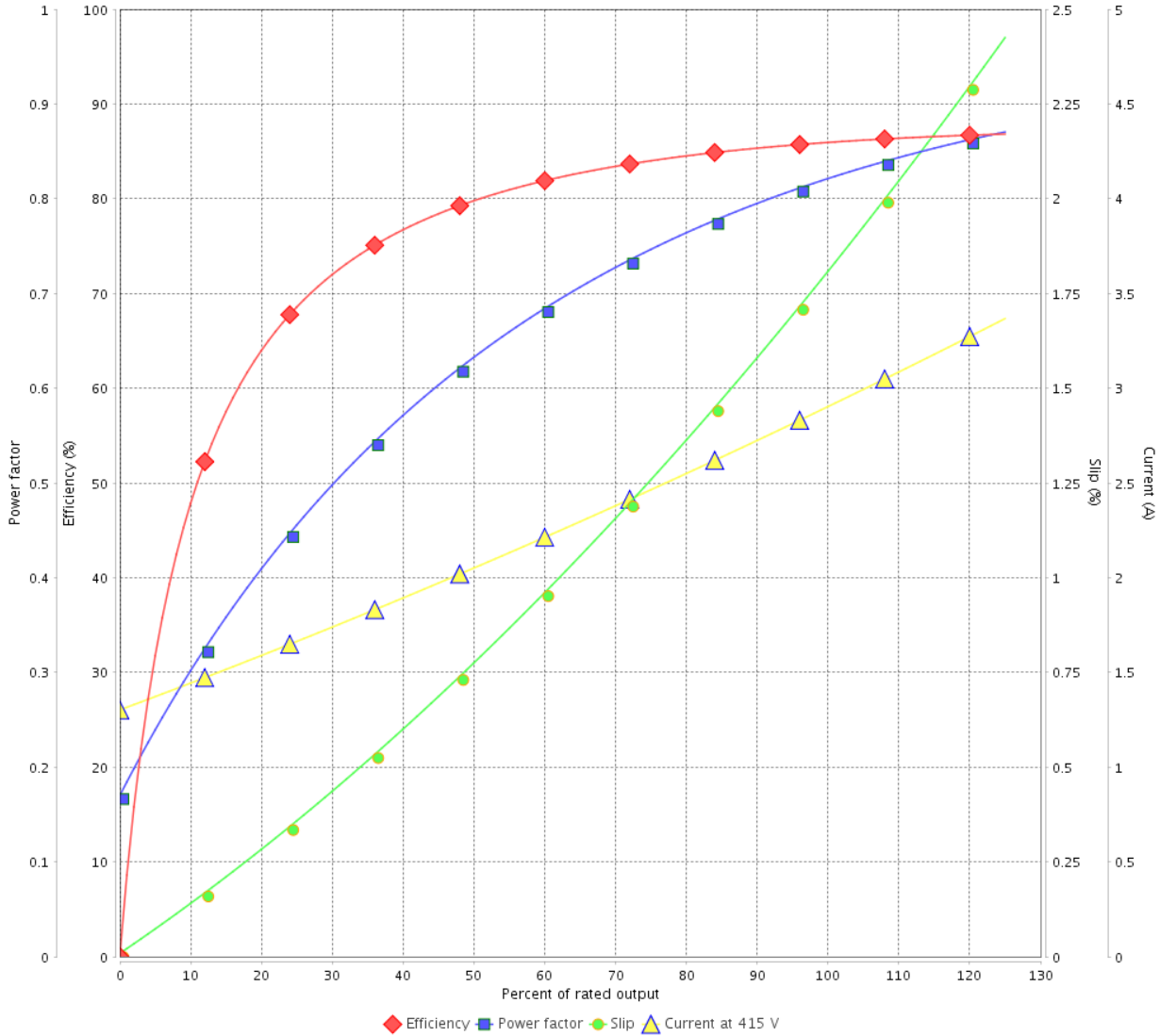

Performance : 415 V 50 Hz 2P IE3

Rated current	: 2.96 A	Moment of inertia (J)	: 0.1889 sq.ft.lb
LRC	: 11.1	Duty cycle	: Cont.(S1)
Rated torque	: 3.57 ft.lb	Insulation class	: F
Locked rotor torque	: 320 %	Service factor	: 1.25
Breakdown torque	: 459 %	Temperature rise	: 80 K
Rated speed	: 2945 rpm	Design	: B

Rev.	Changes Summary	Performed	Checked	Date
Performed by			Page	Revision
Checked by			12 / 36	
Date	13/04/2022			

LOAD PERFORMANCE CURVE

Three Phase Induction Motor - Squirrel Cage



Customer : _____

Product line : NEMA Premium Efficiency Three-Phase

Product code : 12378662

Catalog # : 00336ET3E182T-W22

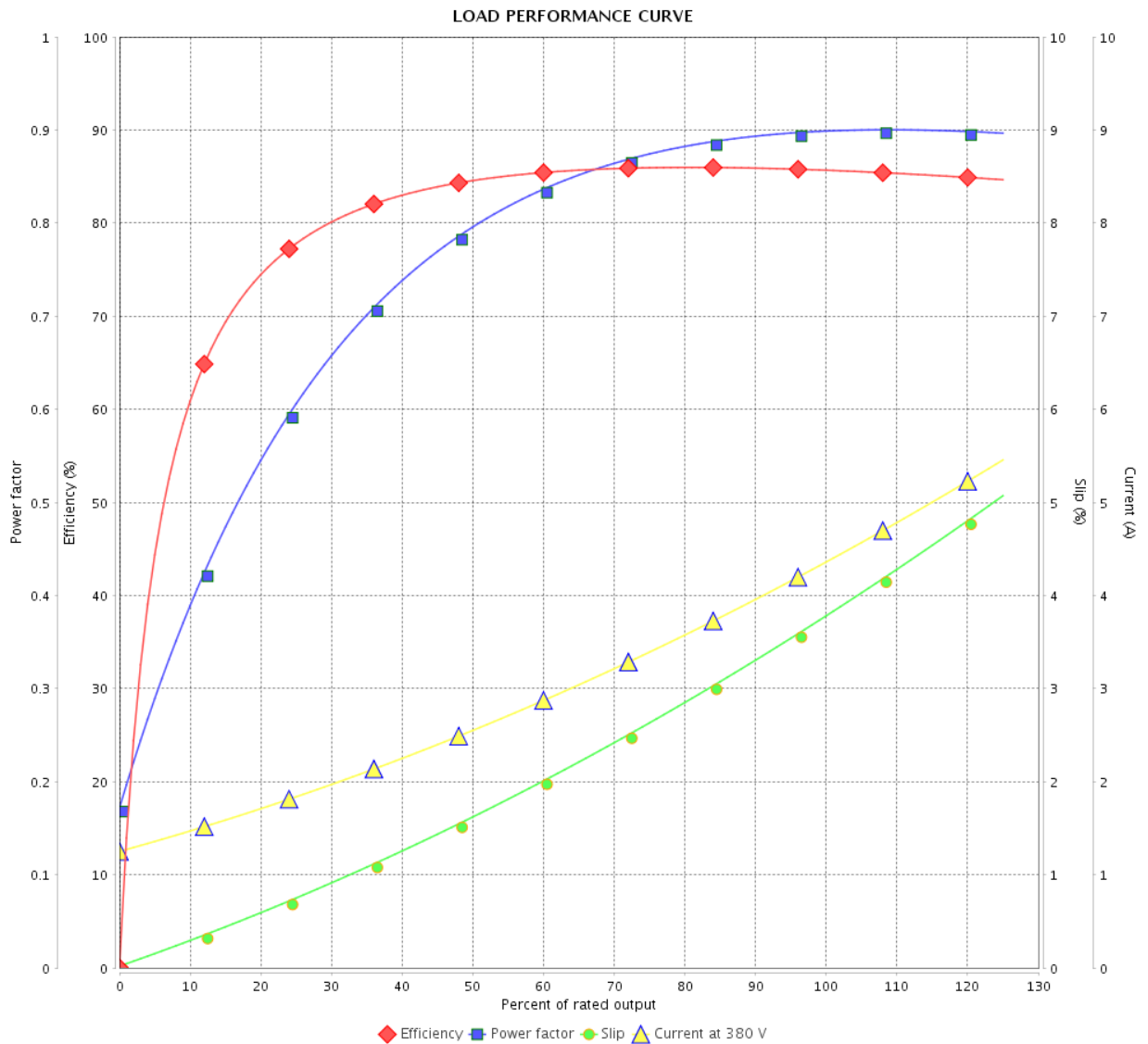

Performance : 380 V 50 Hz 2P IE2

Rated current : 4.34 A
 LRC : 6.8
 Rated torque : 5.46 ft.lb
 Locked rotor torque : 180 %
 Breakdown torque : 250 %
 Rated speed : 2885 rpm

Moment of inertia (J) : 0.1889 sq.ft.lb
 Duty cycle : Cont.(S1)
 Insulation class : F
 Service factor : 1.25
 Temperature rise : 80 K
 Design : B

Rev.	Changes Summary	Performed	Checked	Date
Performed by			Page	Revision
Checked by			13 / 36	
Date	13/04/2022			

LOAD PERFORMANCE CURVE

Three Phase Induction Motor - Squirrel Cage



Customer : _____

Product line : NEMA Premium Efficiency Three-Phase

Product code : 12378662

Catalog # : 00336ET3E182T-W22

LOAD PERFORMANCE CURVE

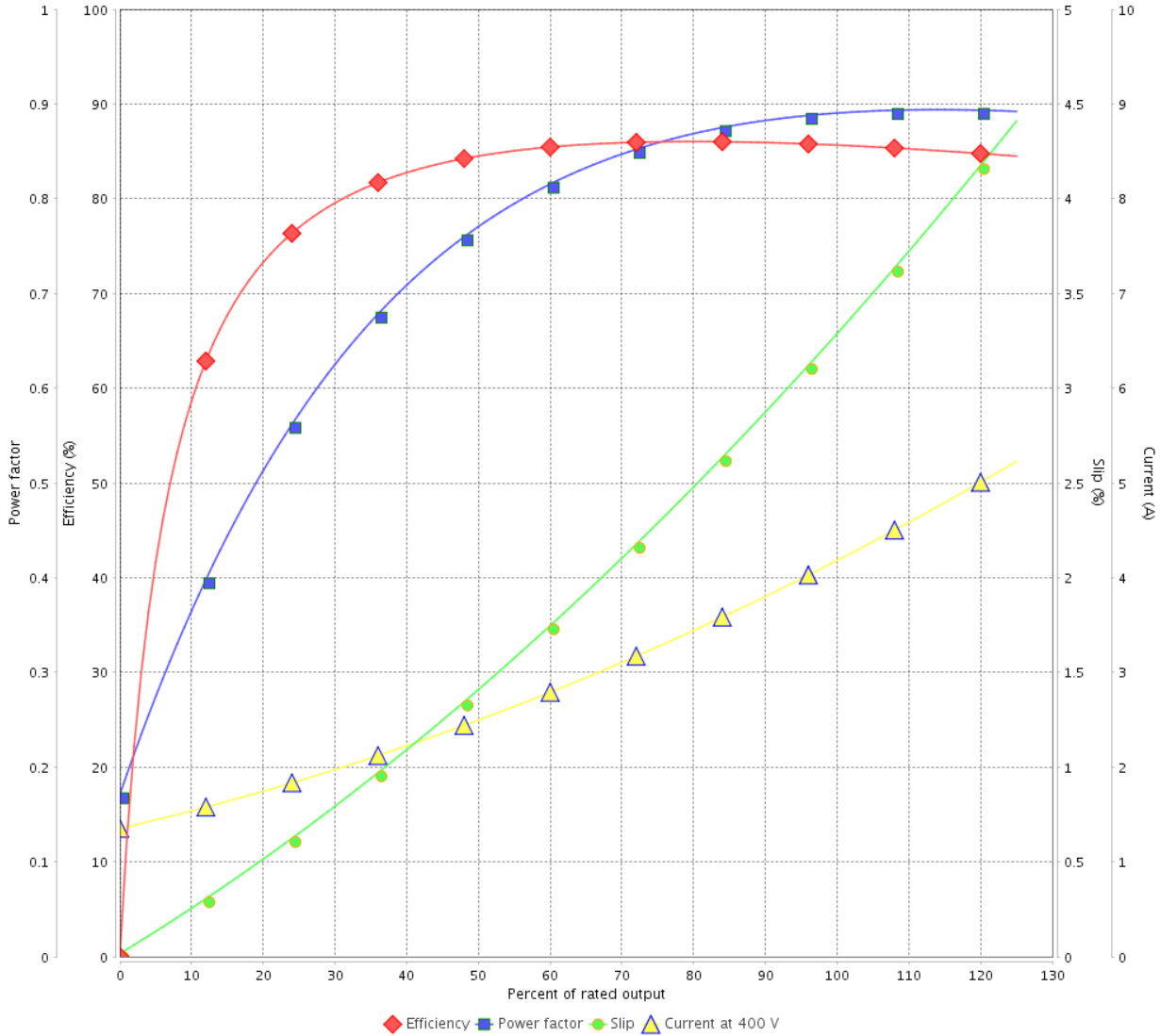

Performance : 400 V 50 Hz 2P IE2

Rated current : 4.17 A
 LRC : 7.6
 Rated torque : 5.43 ft.lb
 Locked rotor torque : 200 %
 Breakdown torque : 280 %
 Rated speed : 2900 rpm

Moment of inertia (J) : 0.1889 sq.ft.lb
 Duty cycle : Cont.(S1)
 Insulation class : F
 Service factor : 1.25
 Temperature rise : 80 K
 Design : B

Rev.	Changes Summary	Performed	Checked	Date
Performed by			Page 14 / 36	Revision
Checked by				
Date	13/04/2022			

LOAD PERFORMANCE CURVE

Three Phase Induction Motor - Squirrel Cage



Customer : _____

Product line : NEMA Premium Efficiency Three-Phase

Product code : 12378662

Catalog # : 00336ET3E182T-W22

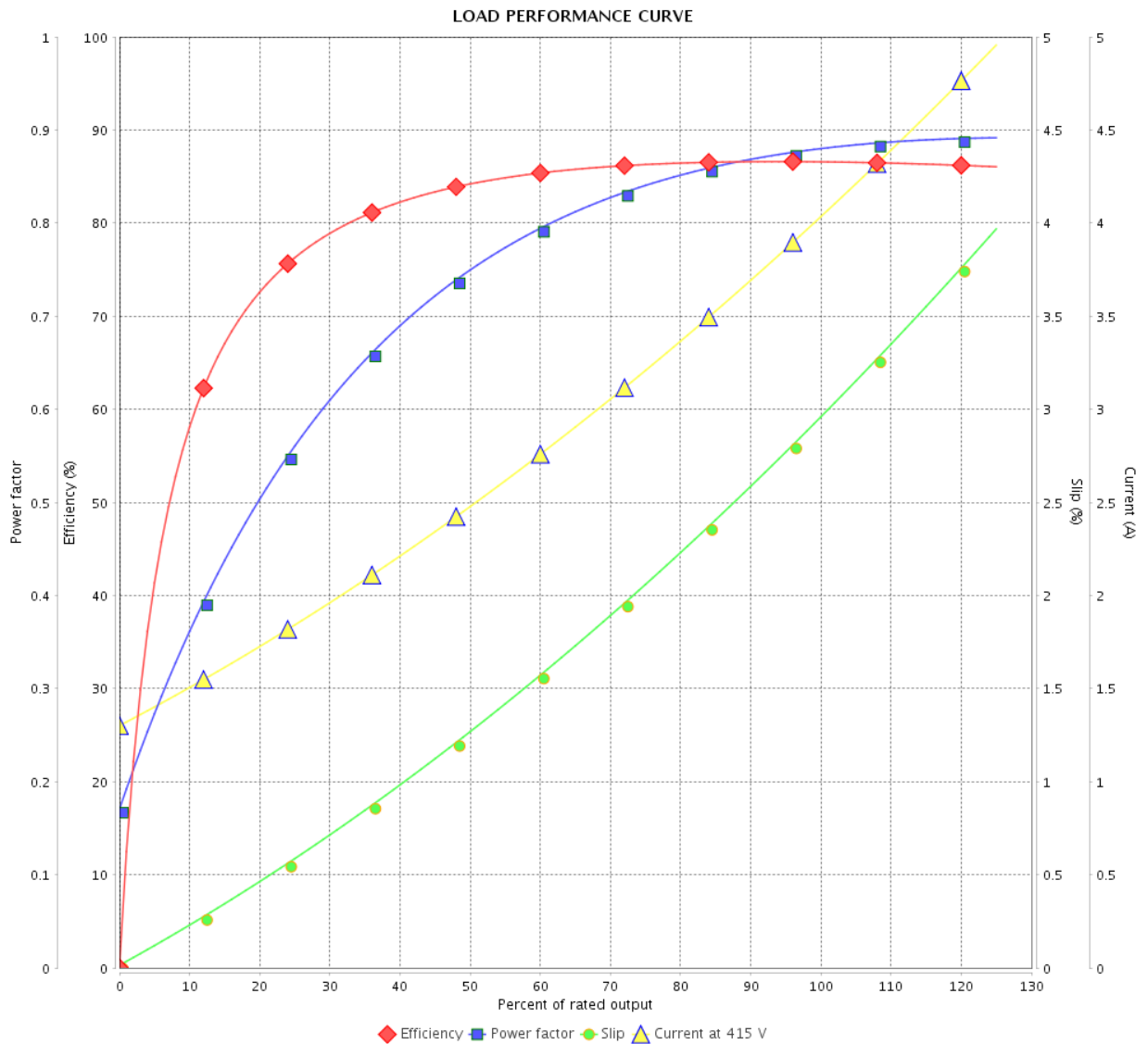

Performance : 415 V 50 Hz 2P IE3

Rated current : 4.02 A
 LRC : 8.1
 Rated torque : 5.41 ft.lb
 Locked rotor torque : 220 %
 Breakdown torque : 310 %
 Rated speed : 2910 rpm

Moment of inertia (J) : 0.1889 sq.ft.lb
 Duty cycle : Cont.(S1)
 Insulation class : F
 Service factor : 1.25
 Temperature rise : 80 K
 Design : B

Rev.	Changes Summary	Performed	Checked	Date
Performed by		Page		Revision
Checked by		15 / 36		
Date		13/04/2022		

THERMAL LIMIT CURVE



Three Phase Induction Motor - Squirrel Cage

Customer :

Product line : NEMA Premium Efficiency Three-Phase
Product code : 12378662
Catalog # : 00336ET3E182T-W22

Performance : 230/460 V 60 Hz 2P

Rated current	: 7.26/3.63 A	Moment of inertia (J)	: 0.1889 sq.ft.lb
LRC	: 8.6	Duty cycle	: Cont.(S1)
Rated torque	: 4.48 ft.lb	Insulation class	: F
Locked rotor torque	: 220 %	Service factor	: 1.25
Breakdown torque	: 340 %	Temperature rise	: 80 K
Rated speed	: 3515 rpm	Design	: B

Heating constant

Cooling constant

Rev.	Changes Summary	Performed	Checked	Date
Performed by				
Checked by			Page	Revision
Date	13/04/2022		16 / 36	

THERMAL LIMIT CURVE

Three Phase Induction Motor - Squirrel Cage



Customer : _____

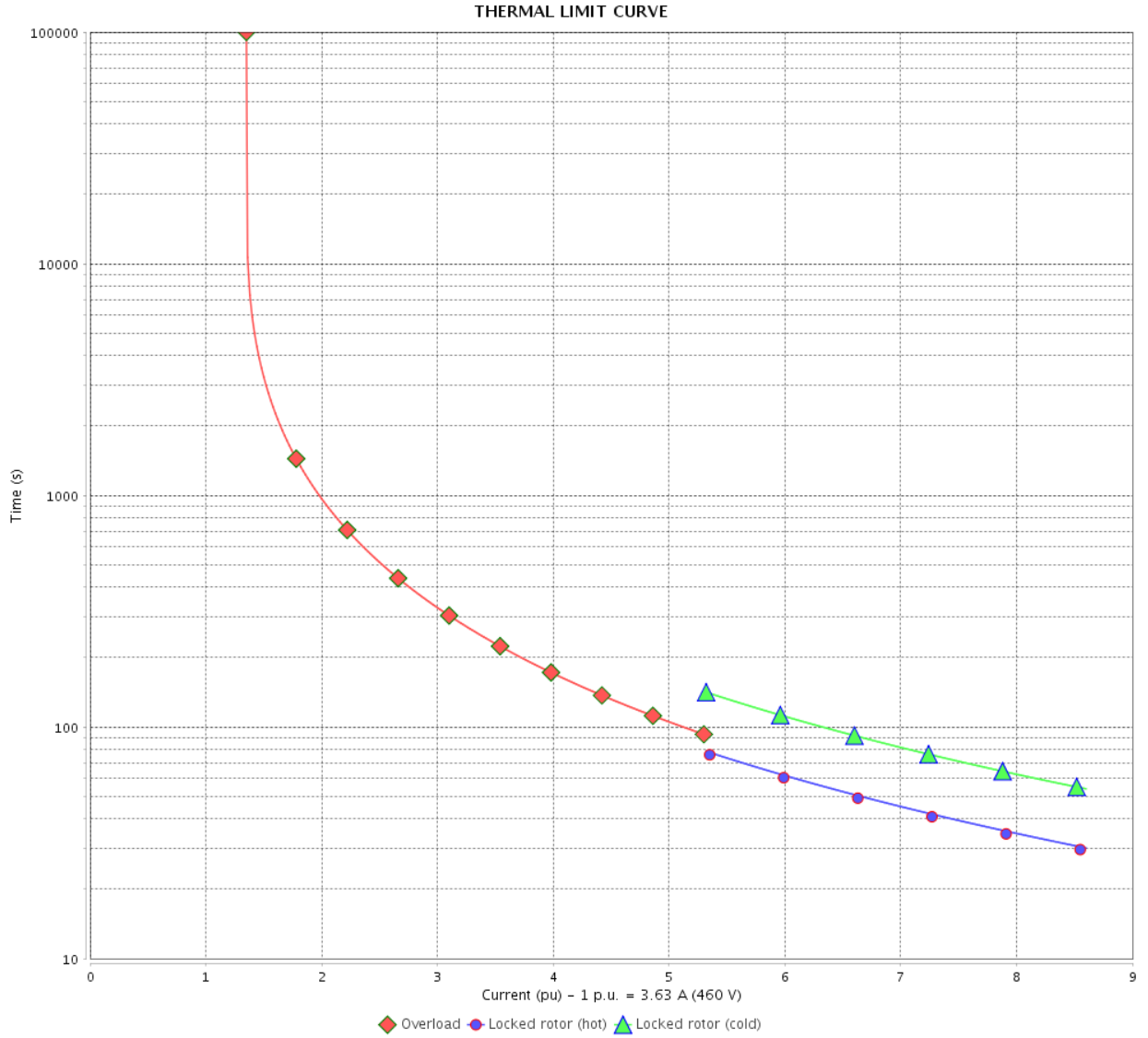

Rev.	Changes Summary	Performed	Checked	Date
Performed by		Page 17 / 36		Revision
Checked by				
Date				

THERMAL LIMIT CURVE



Three Phase Induction Motor - Squirrel Cage

Customer :

Product line : NEMA Premium Efficiency Three-Phase
Product code : 12378662
Catalog # : 00336ET3E182T-W22

Performance : 380 V 50 Hz 2P IE3

Rated current	: 3.09 A	Moment of inertia (J)	: 0.1889 sq.ft.lb
LRC	: 9.6	Duty cycle	: Cont.(S1)
Rated torque	: 3.58 ft.lb	Insulation class	: F
Locked rotor torque	: 240 %	Service factor	: 1.25
Breakdown torque	: 380 %	Temperature rise	: 80 K
Rated speed	: 2930 rpm	Design	: B

Heating constant

Cooling constant

Rev.	Changes Summary	Performed	Checked	Date
Performed by				
Checked by			Page	Revision
Date	13/04/2022		18 / 36	

THERMAL LIMIT CURVE

Three Phase Induction Motor - Squirrel Cage



Customer : _____

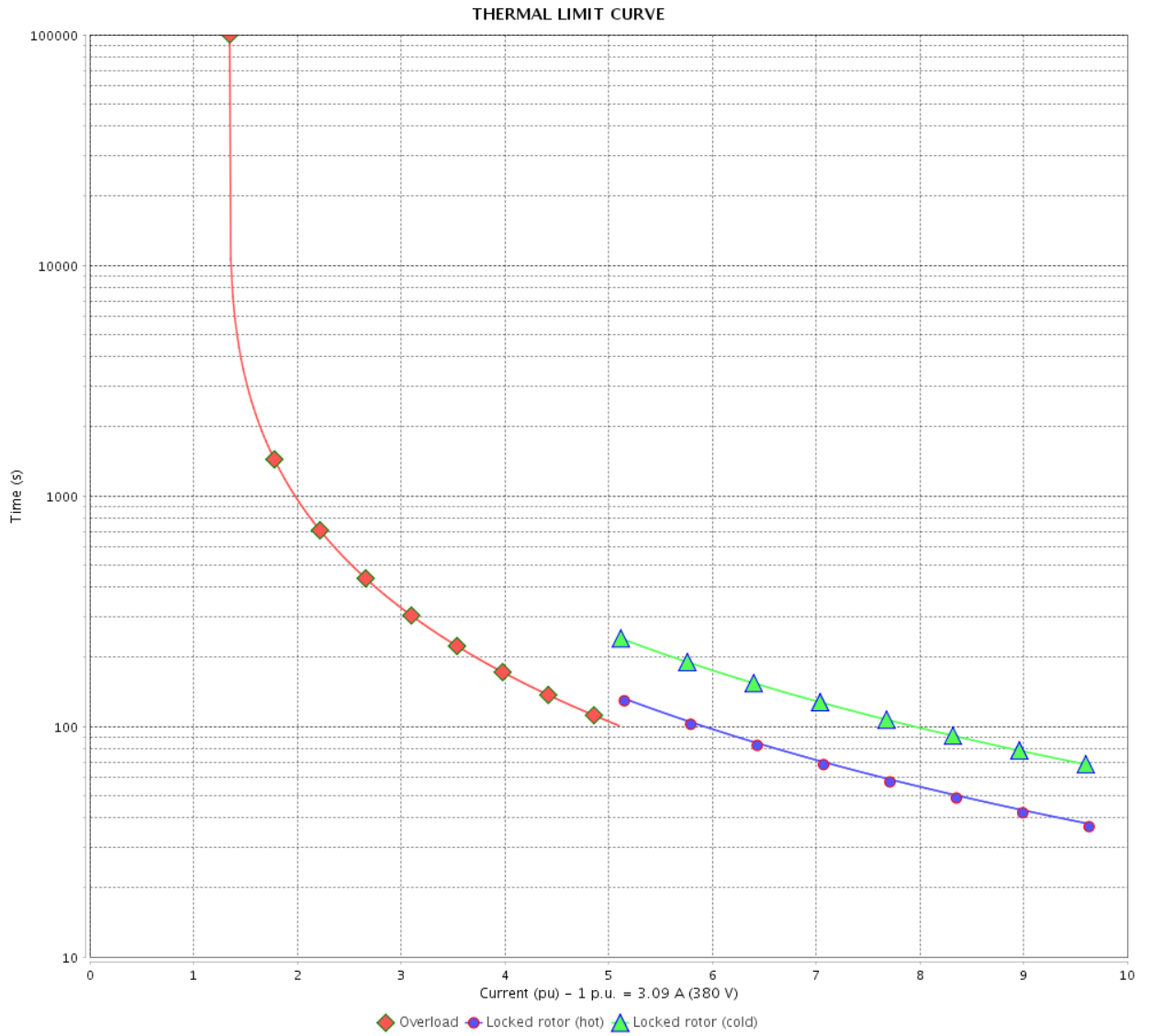

Rev.	Changes Summary	Performed	Checked	Date
Performed by		Page		Revision
Checked by		19 / 36		
Date		13/04/2022		

THERMAL LIMIT CURVE



Three Phase Induction Motor - Squirrel Cage

Customer :

Product line : NEMA Premium Efficiency Three-Phase
Product code : 12378662
Catalog # : 00336ET3E182T-W22

Performance : 400 V 50 Hz 2P IE3

Rated current	: 3.00 A	Moment of inertia (J)	: 0.1889 sq.ft.lb
LRC	: 10.7	Duty cycle	: Cont.(S1)
Rated torque	: 3.57 ft.lb	Insulation class	: F
Locked rotor torque	: 280 %	Service factor	: 1.25
Breakdown torque	: 440 %	Temperature rise	: 80 K
Rated speed	: 2940 rpm	Design	: B

Heating constant

Cooling constant

Rev.	Changes Summary	Performed	Checked	Date
Performed by				
Checked by			Page	Revision
Date	13/04/2022		20 / 36	

THERMAL LIMIT CURVE

Three Phase Induction Motor - Squirrel Cage



Customer : _____

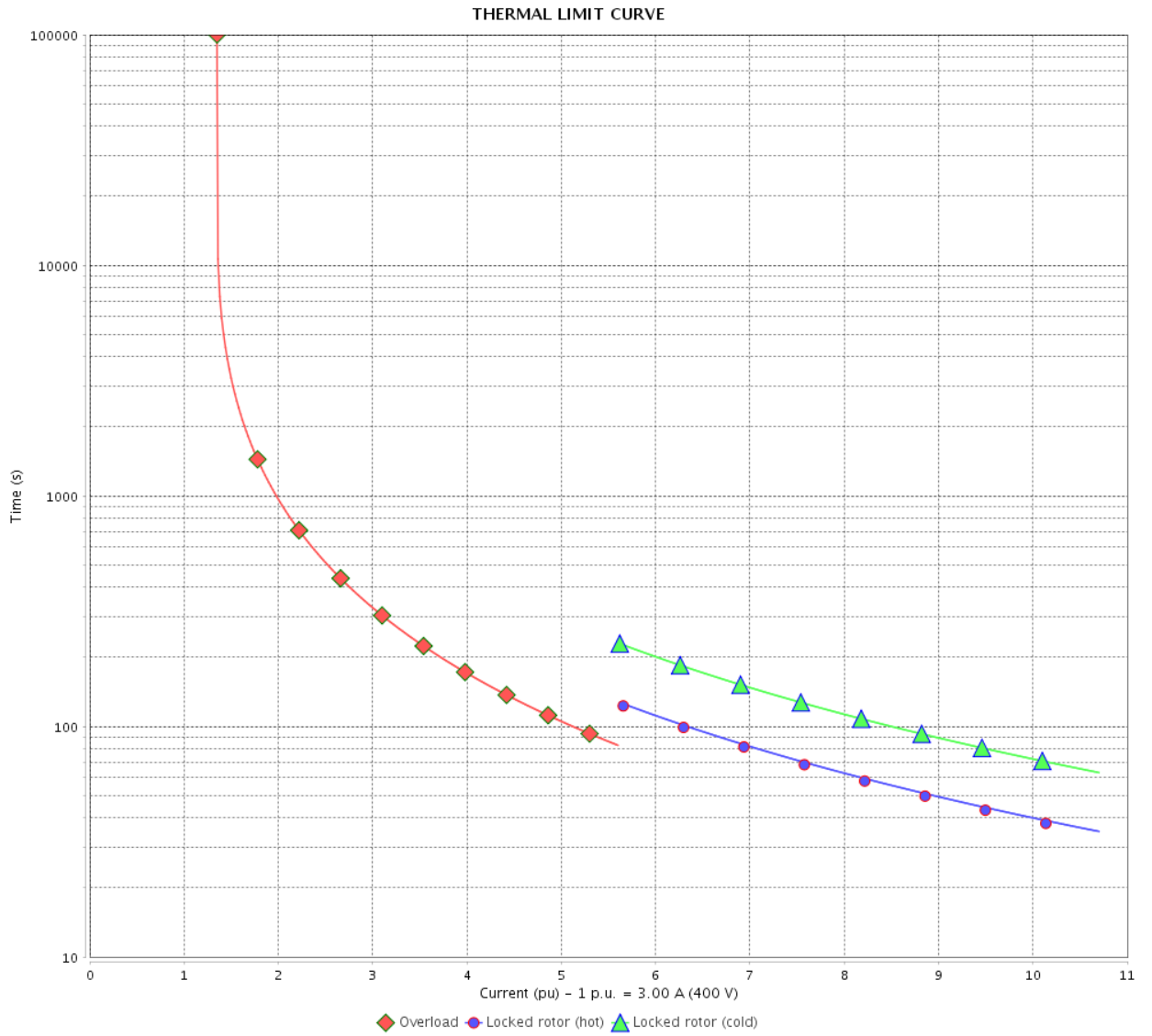

Rev.	Changes Summary	Performed	Checked	Date
Performed by		Page		Revision
Checked by		21 / 36		
Date		13/04/2022		

THERMAL LIMIT CURVE



Three Phase Induction Motor - Squirrel Cage

Customer :

Product line : NEMA Premium Efficiency Three-Phase
Product code : 12378662
Catalog # : 00336ET3E182T-W22

Performance : 415 V 50 Hz 2P IE3

Rated current	: 2.96 A	Moment of inertia (J)	: 0.1889 sq.ft.lb
LRC	: 11.1	Duty cycle	: Cont.(S1)
Rated torque	: 3.57 ft.lb	Insulation class	: F
Locked rotor torque	: 320 %	Service factor	: 1.25
Breakdown torque	: 459 %	Temperature rise	: 80 K
Rated speed	: 2945 rpm	Design	: B

Heating constant

Cooling constant

Rev.	Changes Summary	Performed	Checked	Date
Performed by				
Checked by			Page	Revision
Date	13/04/2022		22 / 36	

THERMAL LIMIT CURVE

Three Phase Induction Motor - Squirrel Cage



Customer : _____

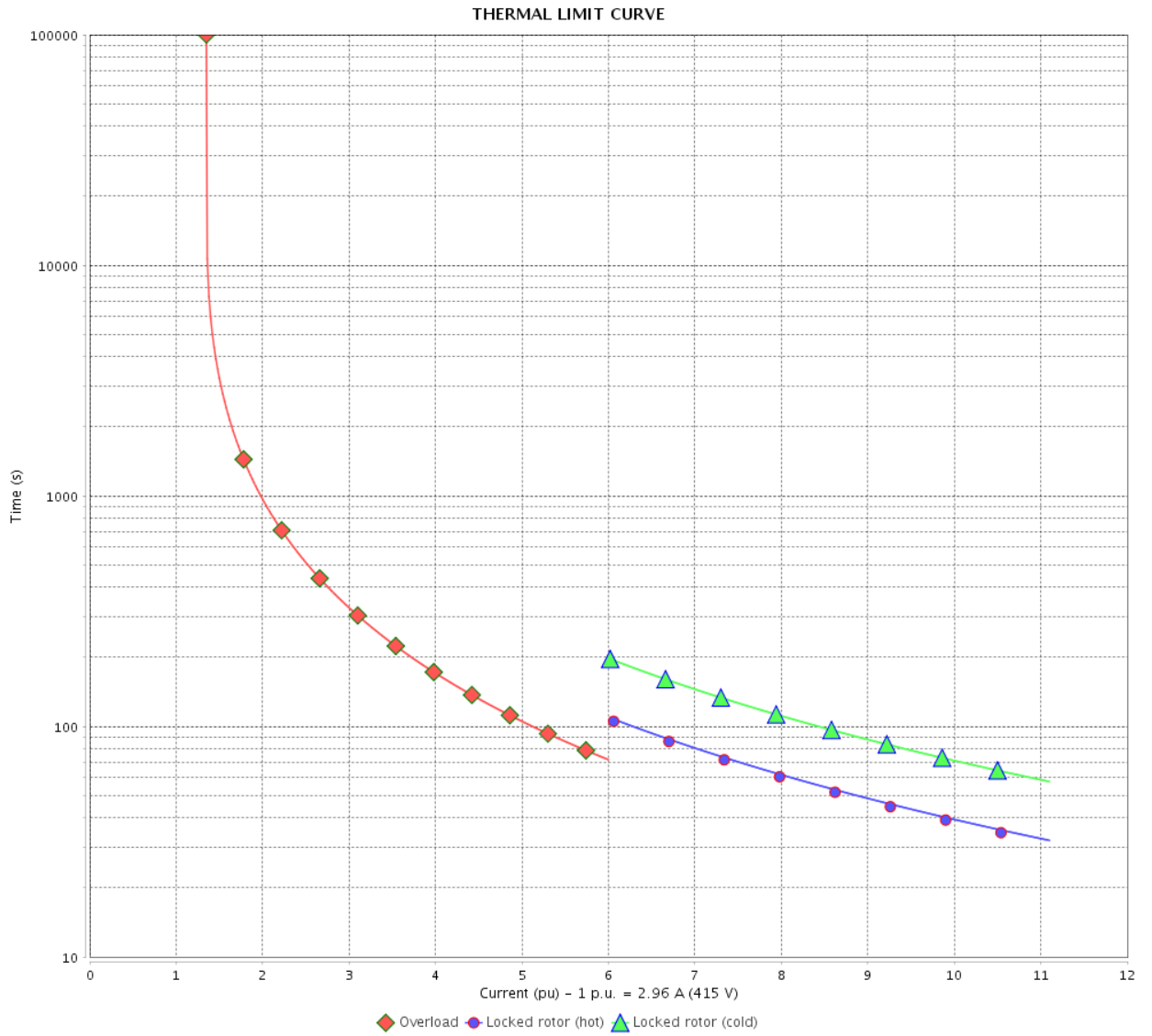

Rev.	Changes Summary	Performed	Checked	Date
Performed by		Page		Revision
Checked by		23 / 36		
Date		13/04/2022		

THERMAL LIMIT CURVE

Three Phase Induction Motor - Squirrel Cage



Customer :

Product line : NEMA Premium Efficiency Three-Phase
Product code : 12378662
Catalog # : 00336ET3E182T-W22

Performance : 380 V 50 Hz 2P IE2

Rated current	: 4.34 A	Moment of inertia (J)	: 0.1889 sq.ft.lb
LRC	: 6.8	Duty cycle	: Cont.(S1)
Rated torque	: 5.46 ft.lb	Insulation class	: F
Locked rotor torque	: 180 %	Service factor	: 1.25
Breakdown torque	: 250 %	Temperature rise	: 80 K
Rated speed	: 2885 rpm	Design	: B

Heating constant

Cooling constant

Rev.	Changes Summary	Performed	Checked	Date
Performed by				
Checked by			Page	Revision
Date	13/04/2022		24 / 36	

THERMAL LIMIT CURVE

Three Phase Induction Motor - Squirrel Cage



Customer : _____

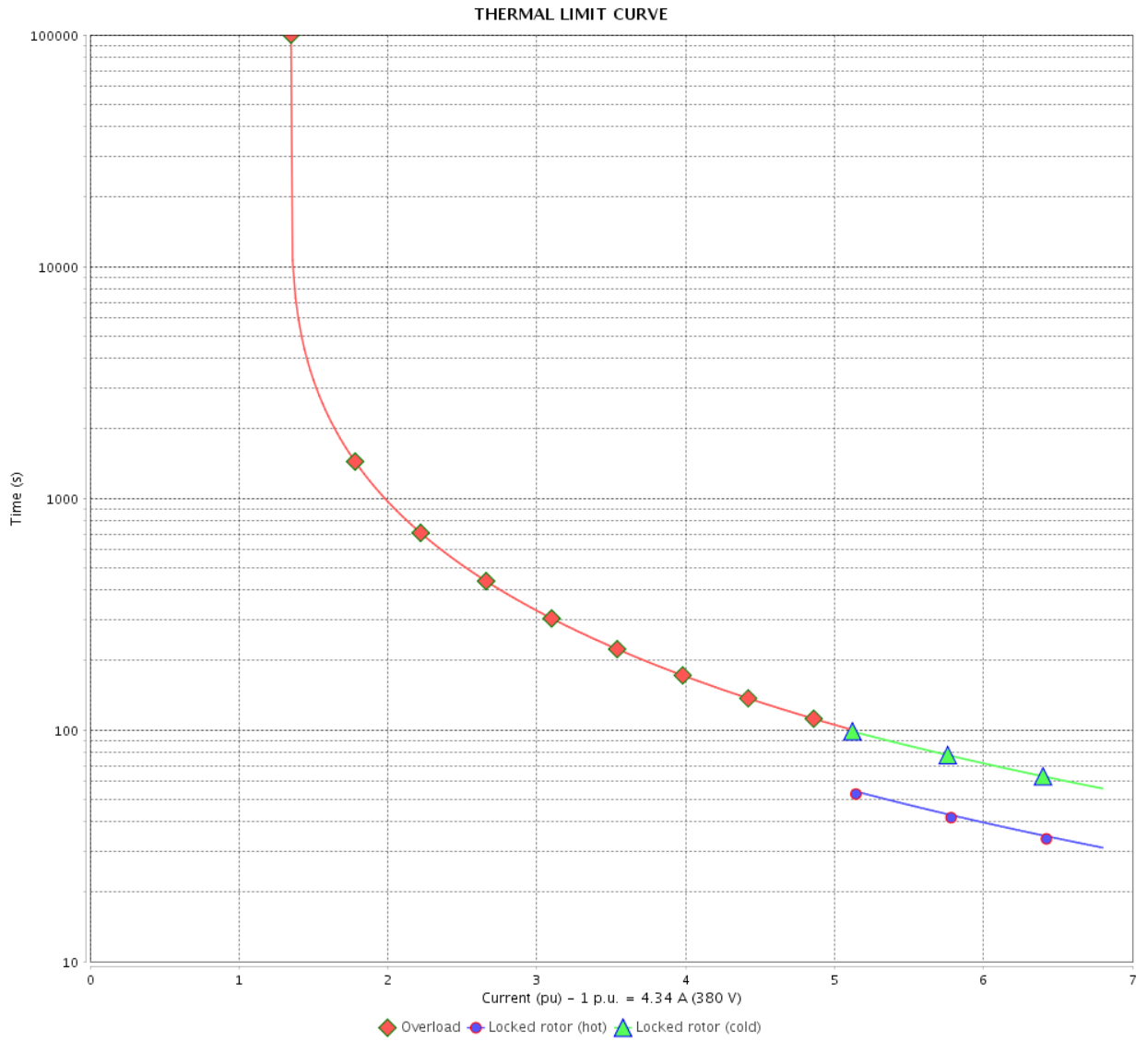

Rev.	Changes Summary	Performed	Checked	Date
Performed by		Page		Revision
Checked by		25 / 36		
Date		13/04/2022		

THERMAL LIMIT CURVE



Three Phase Induction Motor - Squirrel Cage

Customer :

Product line : NEMA Premium Efficiency Three-Phase
Product code : 12378662
Catalog # : 00336ET3E182T-W22

Performance : 400 V 50 Hz 2P IE2

Rated current	: 4.17 A	Moment of inertia (J)	: 0.1889 sq.ft.lb
LRC	: 7.6	Duty cycle	: Cont.(S1)
Rated torque	: 5.43 ft.lb	Insulation class	: F
Locked rotor torque	: 200 %	Service factor	: 1.25
Breakdown torque	: 280 %	Temperature rise	: 80 K
Rated speed	: 2900 rpm	Design	: B

Heating constant

Cooling constant

Rev.	Changes Summary	Performed	Checked	Date
Performed by				
Checked by			Page	Revision
Date	13/04/2022		26 / 36	

THERMAL LIMIT CURVE

Three Phase Induction Motor - Squirrel Cage



Customer : _____

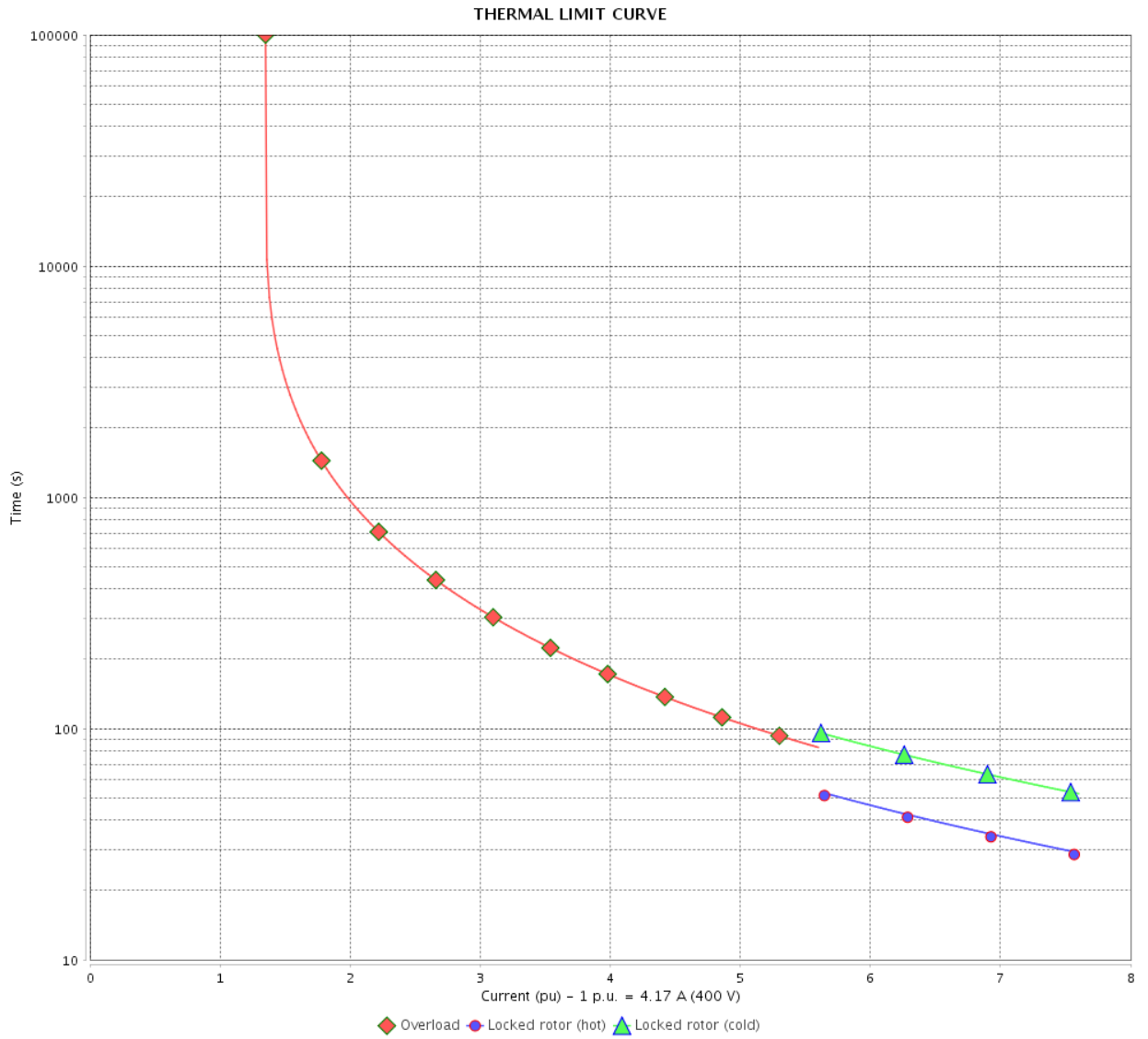

Rev.	Changes Summary	Performed	Checked	Date
Performed by		Page 27 / 36		Revision
Checked by				
Date				

THERMAL LIMIT CURVE



Three Phase Induction Motor - Squirrel Cage

Customer :

Product line : NEMA Premium Efficiency Three-Phase
Product code : 12378662
Catalog # : 00336ET3E182T-W22

Performance : 415 V 50 Hz 2P IE3

Rated current	: 4.02 A	Moment of inertia (J)	: 0.1889 sq.ft.lb
LRC	: 8.1	Duty cycle	: Cont.(S1)
Rated torque	: 5.41 ft.lb	Insulation class	: F
Locked rotor torque	: 220 %	Service factor	: 1.25
Breakdown torque	: 310 %	Temperature rise	: 80 K
Rated speed	: 2910 rpm	Design	: B

Heating constant

Cooling constant

Rev.	Changes Summary	Performed	Checked	Date
Performed by				
Checked by				
Date	13/04/2022		Page 28 / 36	Revision

THERMAL LIMIT CURVE

Three Phase Induction Motor - Squirrel Cage



Customer : _____

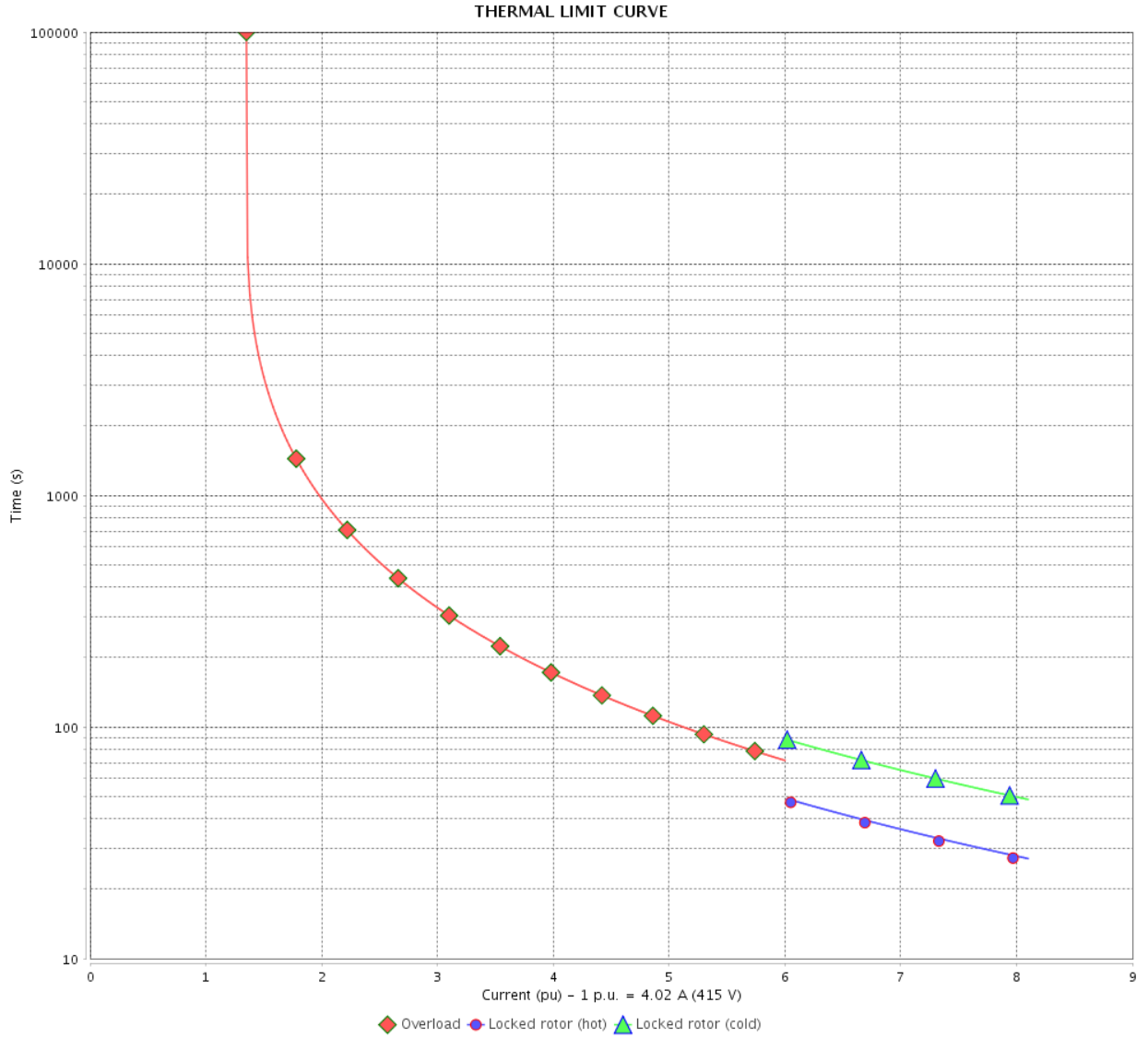

Rev.	Changes Summary	Performed	Checked	Date
Performed by		Page		Revision
Checked by		29 / 36		
Date		13/04/2022		

VFD OPERATION CURVE

Three Phase Induction Motor - Squirrel Cage



Customer : _____

Product line : NEMA Premium Efficiency Three-Phase

Product code : 12378662

Catalog # : 00336ET3E182T-W22

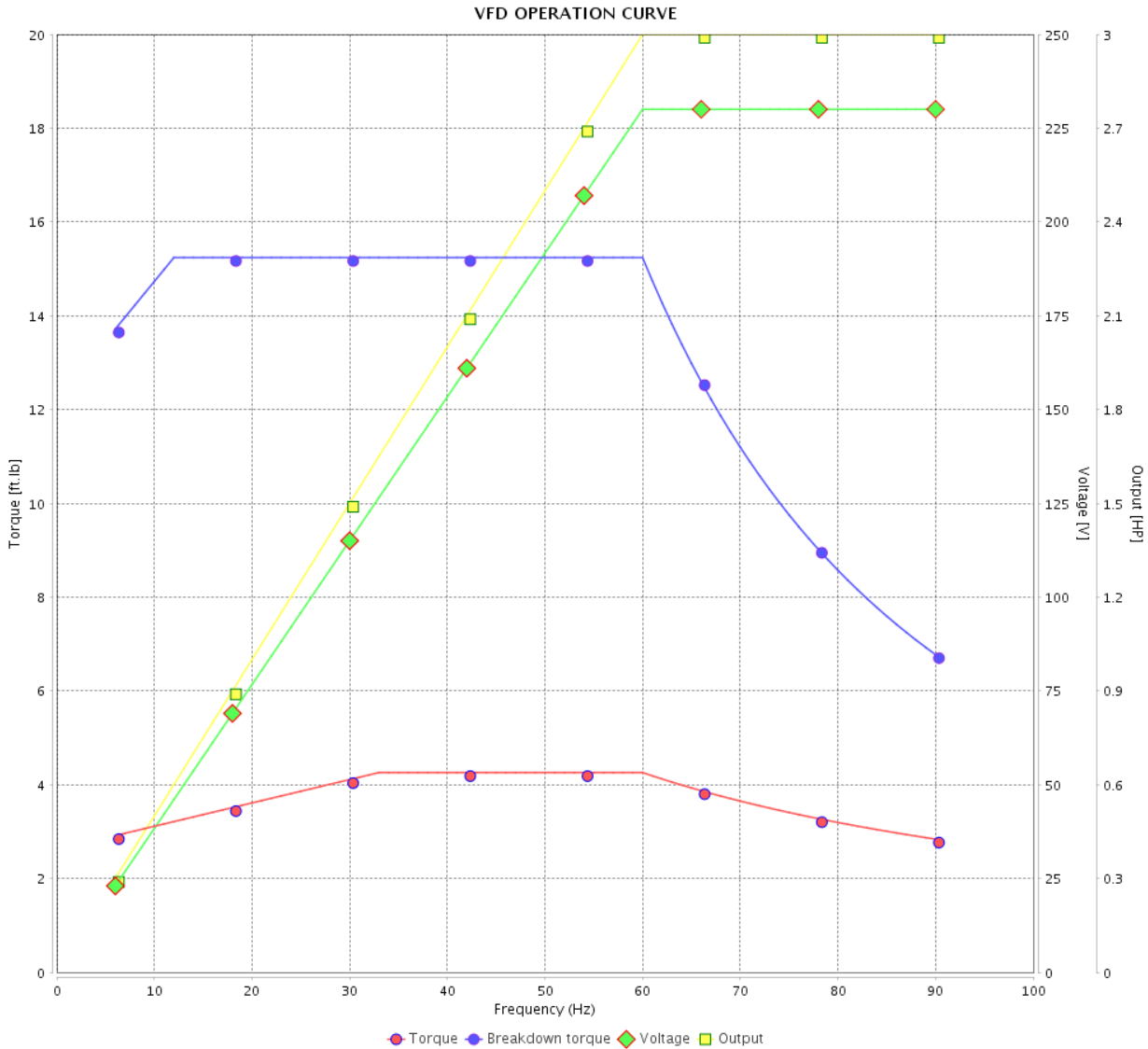

Performance : 230/460 V 60 Hz 2P

Rated current : 7.26/3.63 A
 LRC : 8.6
 Rated torque : 4.48 ft.lb
 Locked rotor torque : 220 %
 Breakdown torque : 340 %
 Rated speed : 3515 rpm

Moment of inertia (J) : 0.1889 sq.ft.lb
 Duty cycle : Cont.(S1)
 Insulation class : F
 Service factor : 1.25
 Temperature rise : 80 K
 Design : B

Rev.	Changes Summary	Performed	Checked	Date
Performed by			Page 30 / 36	Revision
Checked by				
Date	13/04/2022			

VFD OPERATION CURVE

Three Phase Induction Motor - Squirrel Cage



Customer :

Product line : NEMA Premium Efficiency Three-Phase
 Product code : 12378662
 Catalog # : 00336ET3E182T-W22

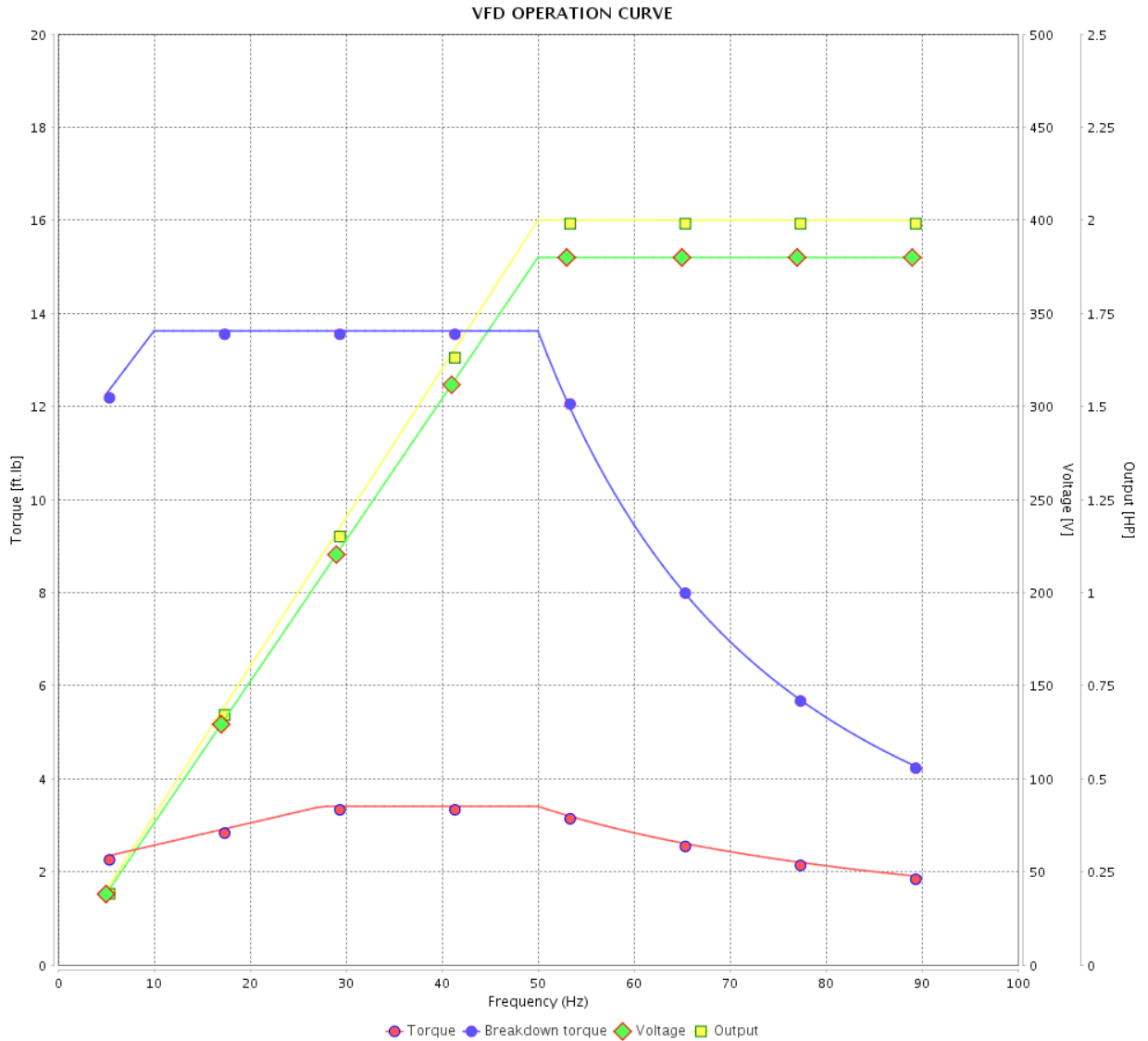

Performance : 380 V 50 Hz 2P IE3

Rated current : 3.09 A
 LRC : 9.6
 Rated torque : 3.58 ft.lb
 Locked rotor torque : 240 %
 Breakdown torque : 380 %
 Rated speed : 2930 rpm

Moment of inertia (J) : 0.1889 sq.ft.lb
 Duty cycle : Cont.(S1)
 Insulation class : F
 Service factor : 1.25
 Temperature rise : 80 K
 Design : B

Rev.	Changes Summary	Performed	Checked	Date
Performed by		Page		Revision
Checked by		31 / 36		
Date		13/04/2022		

VFD OPERATION CURVE

Three Phase Induction Motor - Squirrel Cage



Customer :

Product line : NEMA Premium Efficiency Three-Phase

Product code : 12378662

Catalog # : 00336ET3E182T-W22

VFD OPERATION CURVE

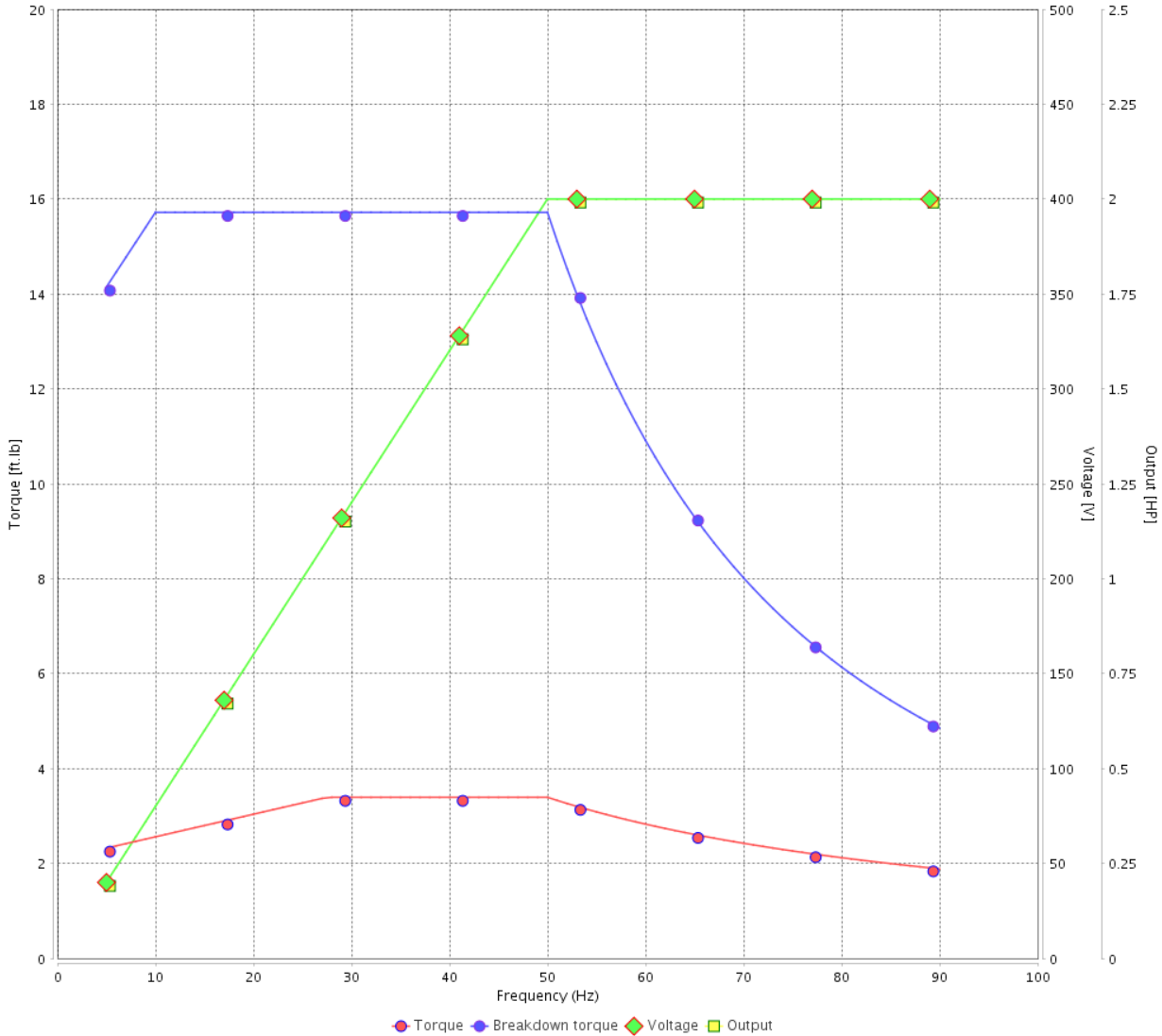

Performance : 400 V 50 Hz 2P IE3

Rated current : 3.00 A
 LRC : 10.7
 Rated torque : 3.57 ft.lb
 Locked rotor torque : 280 %
 Breakdown torque : 440 %
 Rated speed : 2940 rpm

Moment of inertia (J) : 0.1889 sq.ft.lb
 Duty cycle : Cont.(S1)
 Insulation class : F
 Service factor : 1.25
 Temperature rise : 80 K
 Design : B

Rev.	Changes Summary	Performed	Checked	Date
Performed by			Page 32 / 36	Revision
Checked by				
Date	13/04/2022			

VFD OPERATION CURVE

Three Phase Induction Motor - Squirrel Cage



Customer :

Product line : NEMA Premium Efficiency Three-Phase
 Product code : 12378662
 Catalog # : 00336ET3E182T-W22

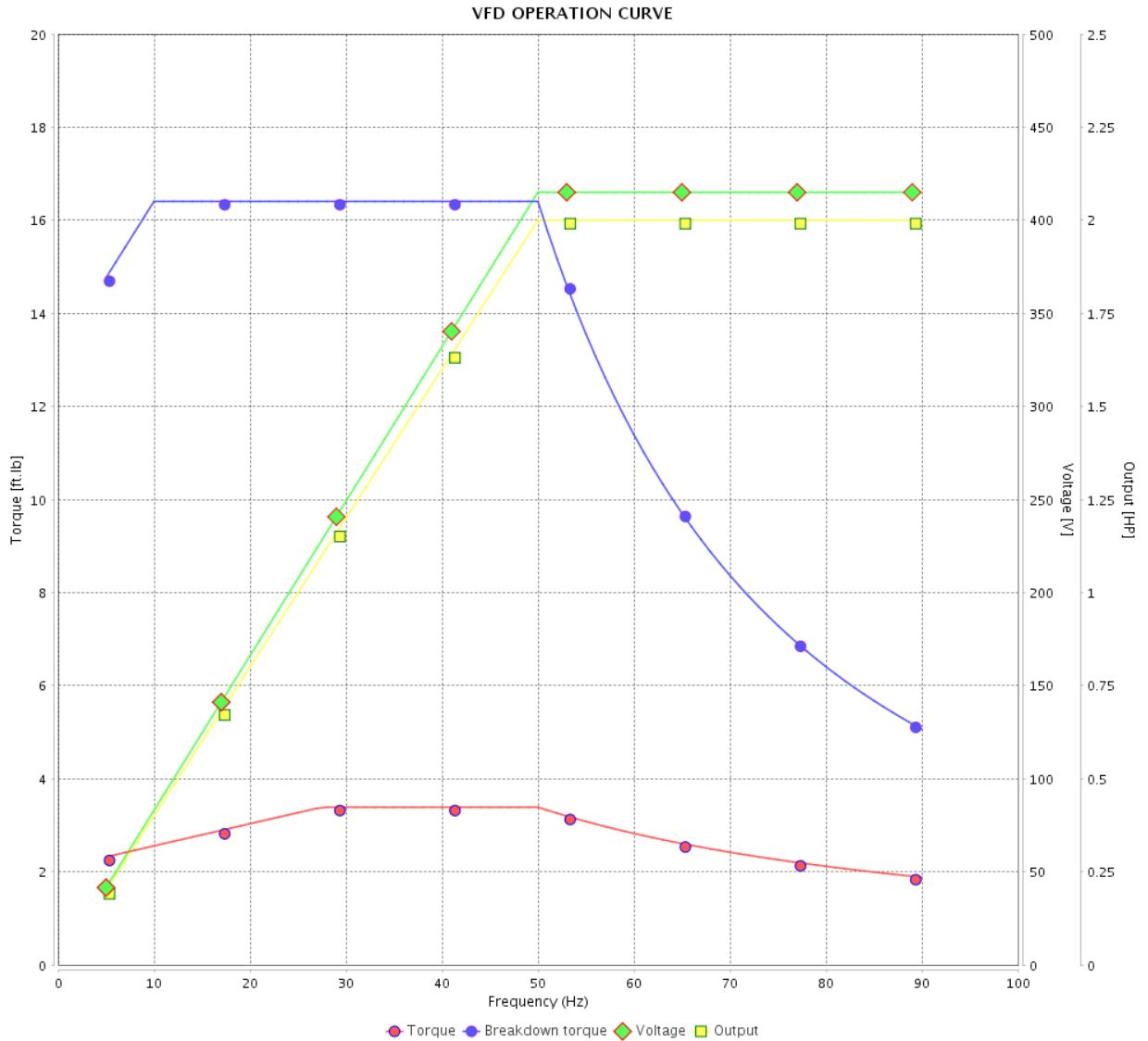

Performance : 415 V 50 Hz 2P IE3

Rated current : 2.96 A
 LRC : 11.1
 Rated torque : 3.57 ft.lb
 Locked rotor torque : 320 %
 Breakdown torque : 459 %
 Rated speed : 2945 rpm

Moment of inertia (J) : 0.1889 sq.ft.lb
 Duty cycle : Cont.(S1)
 Insulation class : F
 Service factor : 1.25
 Temperature rise : 80 K
 Design : B

Rev.	Changes Summary	Performed	Checked	Date
Performed by				Page 33 / 36
Checked by				
Date	13/04/2022			

VFD OPERATION CURVE

Three Phase Induction Motor - Squirrel Cage



Customer : _____

Product line : NEMA Premium Efficiency Three-Phase

Product code : 12378662

Catalog # : 00336ET3E182T-W22

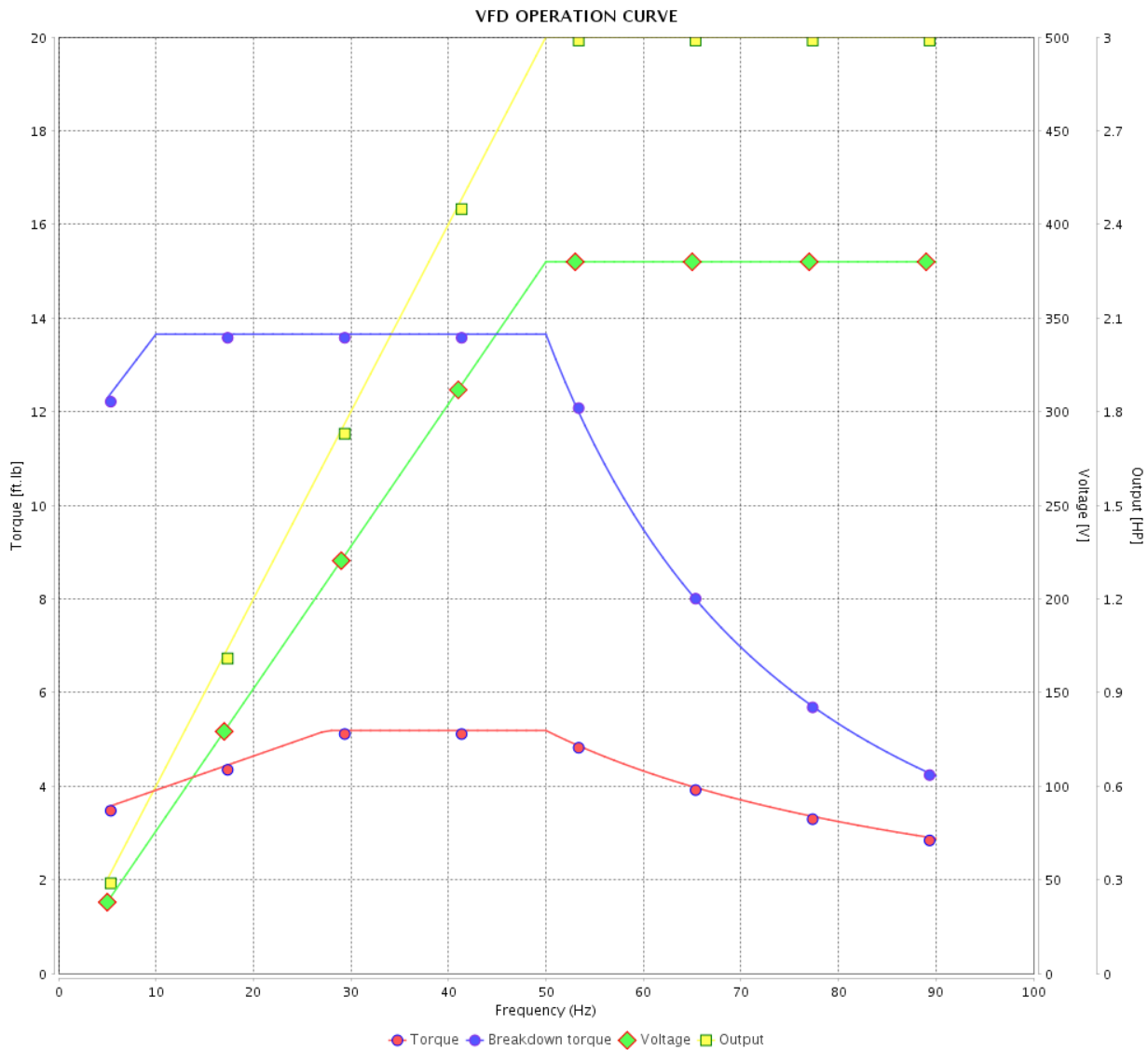

Performance : 380 V 50 Hz 2P IE2

Rated current : 4.34 A
 LRC : 6.8
 Rated torque : 5.46 ft.lb
 Locked rotor torque : 180 %
 Breakdown torque : 250 %
 Rated speed : 2885 rpm

Moment of inertia (J) : 0.1889 sq.ft.lb
 Duty cycle : Cont.(S1)
 Insulation class : F
 Service factor : 1.25
 Temperature rise : 80 K
 Design : B

Rev.	Changes Summary	Performed	Checked	Date
Performed by			Page 34 / 36	Revision
Checked by				
Date	13/04/2022			

VFD OPERATION CURVE

Three Phase Induction Motor - Squirrel Cage



Customer :

Product line : NEMA Premium Efficiency Three-Phase

Product code : 12378662

Catalog # : 00336ET3E182T-W22

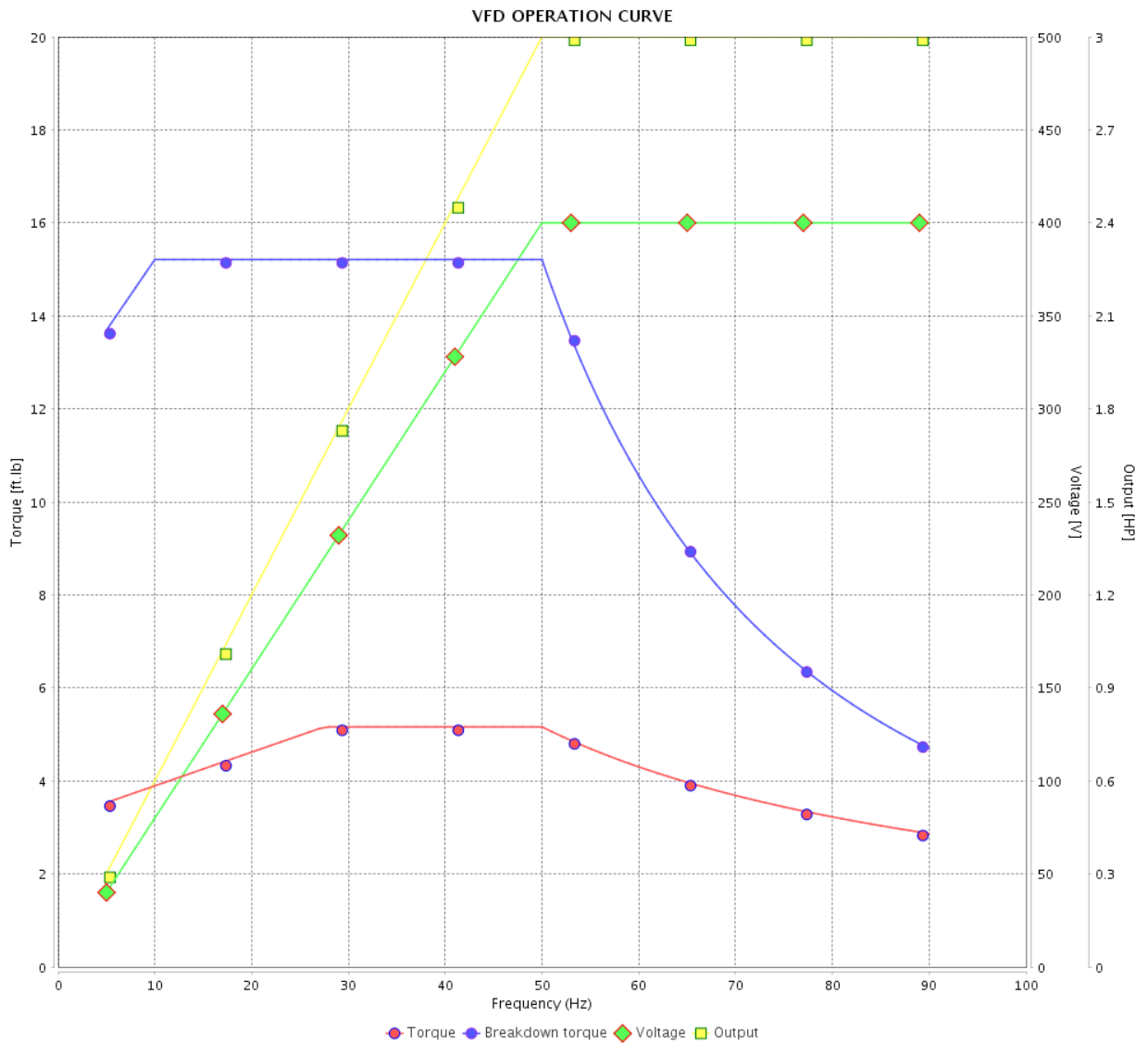

Performance : 400 V 50 Hz 2P IE2

Rated current : 4.17 A
 LRC : 7.6
 Rated torque : 5.43 ft.lb
 Locked rotor torque : 200 %
 Breakdown torque : 280 %
 Rated speed : 2900 rpm

Moment of inertia (J) : 0.1889 sq.ft.lb
 Duty cycle : Cont.(S1)
 Insulation class : F
 Service factor : 1.25
 Temperature rise : 80 K
 Design : B

Rev.	Changes Summary	Performed	Checked	Date
Performed by		Page		Revision
Checked by		35 / 36		
Date		13/04/2022		

VFD OPERATION CURVE

Three Phase Induction Motor - Squirrel Cage



Customer :

Product line : NEMA Premium Efficiency Three-Phase

Product code : 12378662

Catalog # : 00336ET3E182T-W22

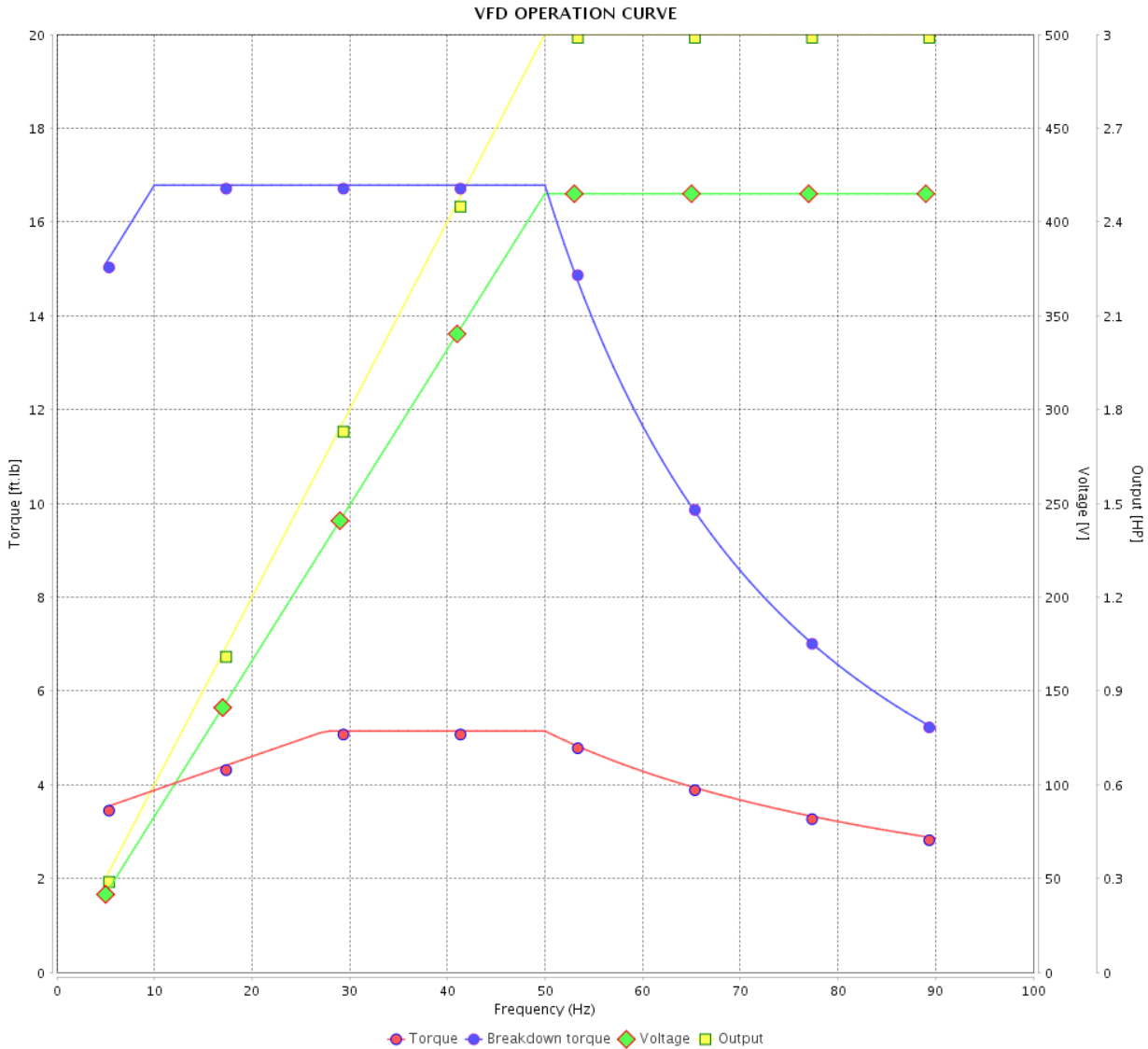

Performance : 415 V 50 Hz 2P IE3

Rated current : 4.02 A
 LRC : 8.1
 Rated torque : 5.41 ft.lb
 Locked rotor torque : 220 %
 Breakdown torque : 310 %
 Rated speed : 2910 rpm

Moment of inertia (J) : 0.1889 sq.ft.lb
 Duty cycle : Cont.(S1)
 Insulation class : F
 Service factor : 1.25
 Temperature rise : 80 K
 Design : B

Rev.	Changes Summary	Performed	Checked	Date
Performed by			Page 36 / 36	Revision
Checked by				
Date	13/04/2022			

1 2 3 4 5 6

A

B

C

D

E

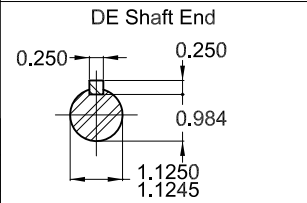
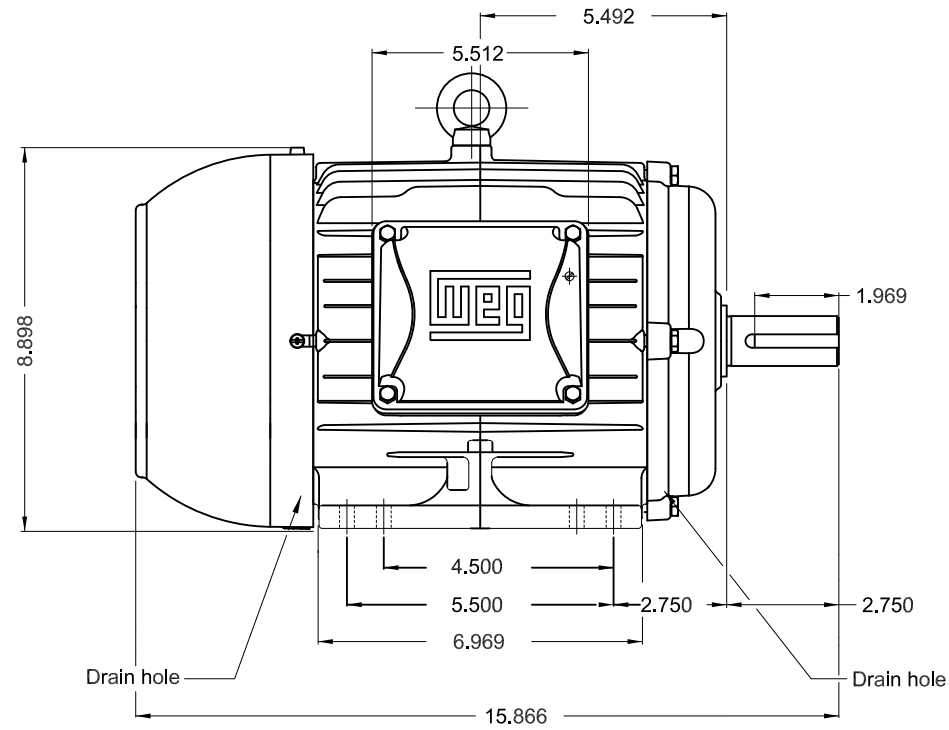
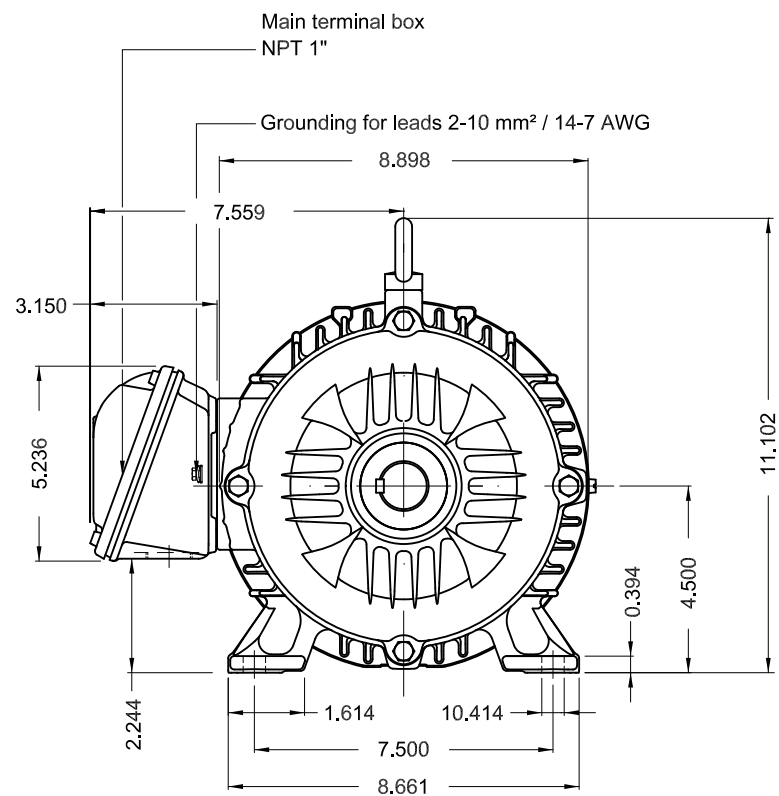

Color RAL 5009
 Painting plan 207A
 Mounting B3R(D)

3 HP 02 Poles 60 Hz A

ECM	LOC	SUMMARY OF MODIFICATIONS	EXECUTED	CHECKED	RELEASED	DATE	VER
EXECUTED	PIRWBUSER	THREE PH. MOTOR W22 PREM. EFF.					
CHECKED		FRAME 182/4T IP55 TEFC					
RELEASED							
REL DT.	WMO	Jaragua do Sul	Product Engineering	SHEET	1 / 1		

PREVIEW
WDD



MADE IN BRAZIL
12378662



MODEL 00336ET3E182T-W22

Inverter Duty Motor
Severe Duty



For use on 60Hz
Class I, Div 2, Gr A, B, C and D - T3
Class I, Zone 2, IIC - T3
Class II, Div 2, Gr F and G - T5
For use on PWM: Gr. A, B, C, D, F and G,
VT 1000:1, CT 20:1, 1.00SF - T4A



FOR SAFE AREA
Mod. TE1BFOXON
CC029A

PH3 60Hz Fr. 182/4T 1000m.a.s.l. IP55 TEFC 86lb

V 230/460

A 7.26/3.63

HP 3.0

kW 2.2

SF 1.25

SFA 9.07/4.54

RPM 3515

PF 0.88

AMB 40°C

INS cl. F DT80K

NEMA NOM EFF 86.5%

DUTY CONT.

DES B Code K

USABLE @208V 8.01A SF 1.15 SFA 9.21

3.0HP 2.2kW 50Hz 380V 4.34A 2885RPM SF 1.25 SFA 5.42 EFF 85.5% (IE2)

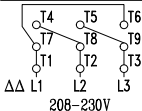

208-230V

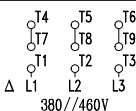

380//460V



MOBIL POLYREX EM