

# DATA SHEET



## Three Phase Induction Motor - Squirrel Cage

Customer								
Product line		: NEMA Premium Efficiency Three-Phase			Product code :		13468368	
					Catalog # :		00336ET3ER145TC-W22	
Frame : 145TC Insulation class : F Duty cycle : Cont.(S1) Ambient temperature : -20°C to +40°C Altitude : 1000 m.a.s.l. Protection degree : IP55 Design : B				Cooling method : IC411 - TEFC Mounting : W-6 Rotation <sup>1</sup> : Both (CW and CCW) Starting method : Direct On Line Approx. weight <sup>2</sup> : 53.4 lb Moment of inertia (J) : 0.0605 sq.ft.lb				
Output [HP]	3	2	2	2	3	3	3	
Poles	2	2	2	2	2	2	2	
Frequency [Hz]	60	50	50	50	50	50	50	
Rated voltage [V]	230/460	380	400	415	380	400	415	
Rated current [A]	7.42/3.71	3.24	3.17	3.15	4.44	4.26	4.13	
L. R. Amperes [A]	60.1/30.1	27.9	29.2	29.9	27.1	28.5	29.3	
LRC [A]	8.1x(Code J)	8.6x(Code L)	9.2x(Code M)	9.5x(Code M)	6.1x(Code G)	6.7x(Code H)	7.1x(Code H)	
No load current [A]	2.60/1.30	1.28	1.43	1.55	1.28	1.43	1.55	
Rated speed [RPM]	3460	2890	2905	2910	2820	2840	2850	
Slip [%]	3.89	3.67	3.17	3.00	6.00	5.33	5.00	
Rated torque [ft.lb]	4.55	3.63	3.62	3.61	5.59	5.55	5.53	
Locked rotor torque [%]	330	400	459	490	260	300	320	
Breakdown torque [%]	360	400	459	509	260	300	330	
Service factor	1.25	1.25	1.00	1.00	1.25	1.00	1.00	
Temperature rise	80 K	80 K	80 K	80 K	80 K	80 K	80 K	
Locked rotor time	25s (cold)	25s (cold)	23s (cold)	23s (cold)	25s (cold)	23s (cold)	23s (cold)	
	14s (hot)	14s (hot)	13s (hot)	13s (hot)	14s (hot)	13s (hot)	13s (hot)	
Noise level <sup>2</sup>	68.0 dB(A)	62.0 dB(A)	62.0 dB(A)	62.0 dB(A)	62.0 dB(A)	62.0 dB(A)	62.0 dB(A)	
Efficiency (%)	25%	85.2	80.8	80.9	80.9	83.9	84.0	84.4
	50%	85.5	81.9	82.0	82.2	84.0	84.5	85.0
	75%	86.5	84.0	84.4	84.8	85.0	85.5	86.0
	100%	86.5	84.8	85.3	85.9	84.6	85.6	86.2
Power Factor	25%	0.47	0.41	0.37	0.34	0.54	0.49	0.45
	50%	0.70	0.63	0.58	0.55	0.76	0.72	0.69
	75%	0.81	0.76	0.72	0.69	0.85	0.82	0.80
	100%	0.86	0.83	0.80	0.77	0.89	0.87	0.86
Bearing type		Drive end : 6205 ZZ	Non drive end : 6204 ZZ	Foundation loads				
Sealing		: V'Ring	: V'Ring	Max. traction		: 132 lb		
Lubrication interval		: -	: -	Max. compression		: 185 lb		
Lubricant amount		: -	: -					
Lubricant type		: Mobil Polyrex EM						
Notes								
This revision replaces and cancel the previous one, which must be eliminated. (1) Looking the motor from the shaft end. (2) Measured at 1m and with tolerance of +3dB(A). (3) Approximate weight subject to changes after manufacturing process. (4) At 100% of full load.				These are average values based on tests with sinusoidal power supply, subject to the tolerances stipulated in NEMA MG-1.				
Rev.	Changes Summary			Performed	Checked	Date		
Performed by								
Checked by					Page	Revision		
Date	13/04/2022				1 / 36			

# TORQUE AND CURRENT VS SPEED CURVE

Three Phase Induction Motor - Squirrel Cage



Customer :

Product line : NEMA Premium Efficiency Three-Phase

Product code : 13468368

Catalog # : 00336ET3ER145TC-W22

TORQUE AND CURRENT VS SPEED CURVE

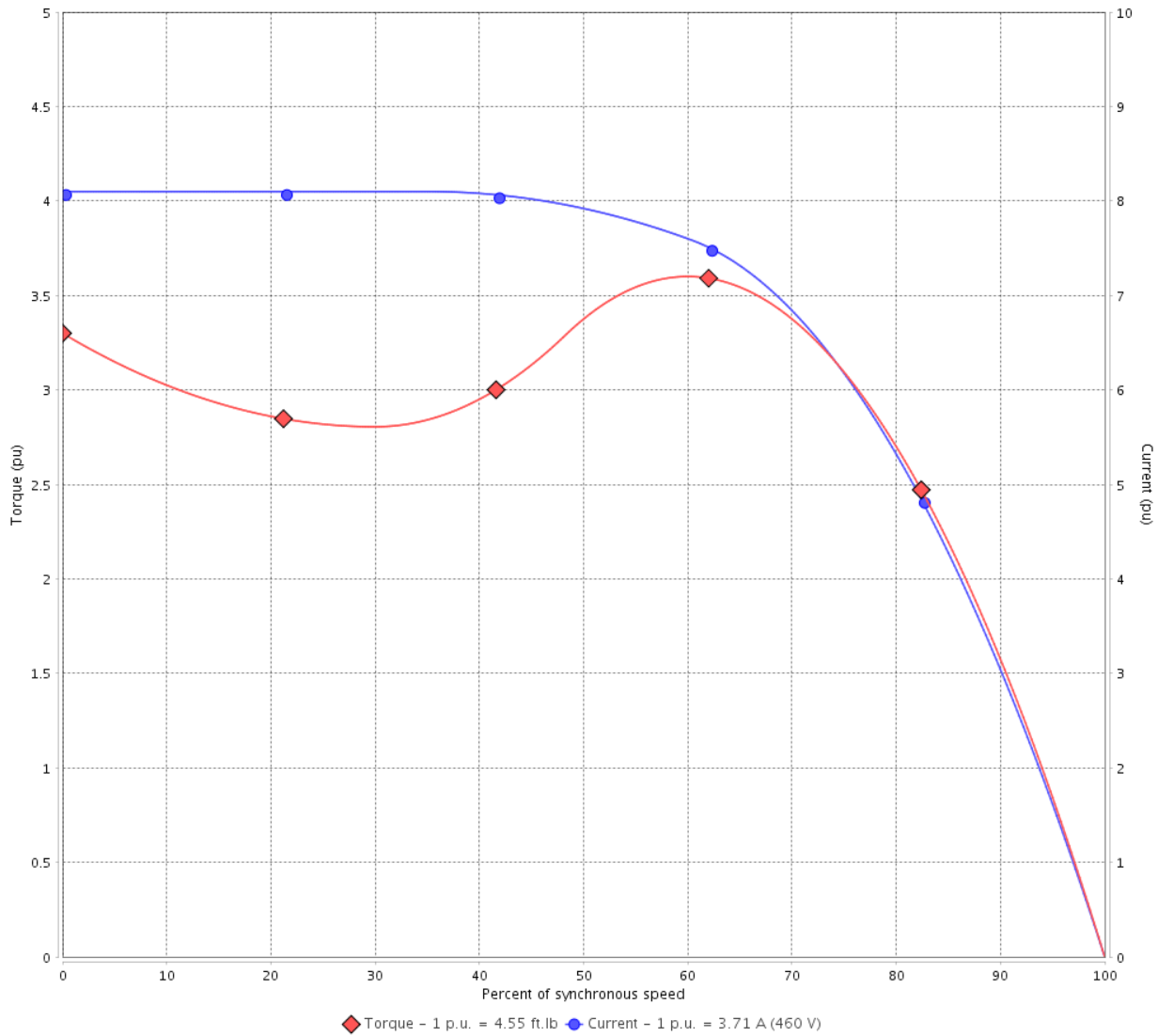

Performance : 230/460 V 60 Hz 2P

Rated current : 7.42/3.71 A  
 LRC : 8.1  
 Rated torque : 4.55 ft.lb  
 Locked rotor torque : 330 %  
 Breakdown torque : 360 %  
 Rated speed : 3460 rpm

Moment of inertia (J) : 0.0605 sq.ft.lb  
 Duty cycle : Cont.(S1)  
 Insulation class : F  
 Service factor : 1.25  
 Temperature rise : 80 K  
 Design : B

Locked rotor time : 25s (cold) 14s (hot)

Rev.	Changes Summary	Performed	Checked	Date
Performed by			Page 2 / 36	Revision
Checked by				
Date	13/04/2022			

# TORQUE AND CURRENT VS SPEED CURVE



## Three Phase Induction Motor - Squirrel Cage

Customer :

Product line : NEMA Premium Efficiency Three-Phase

Product code : 13468368

Catalog # : 00336ET3ER145TC-W22

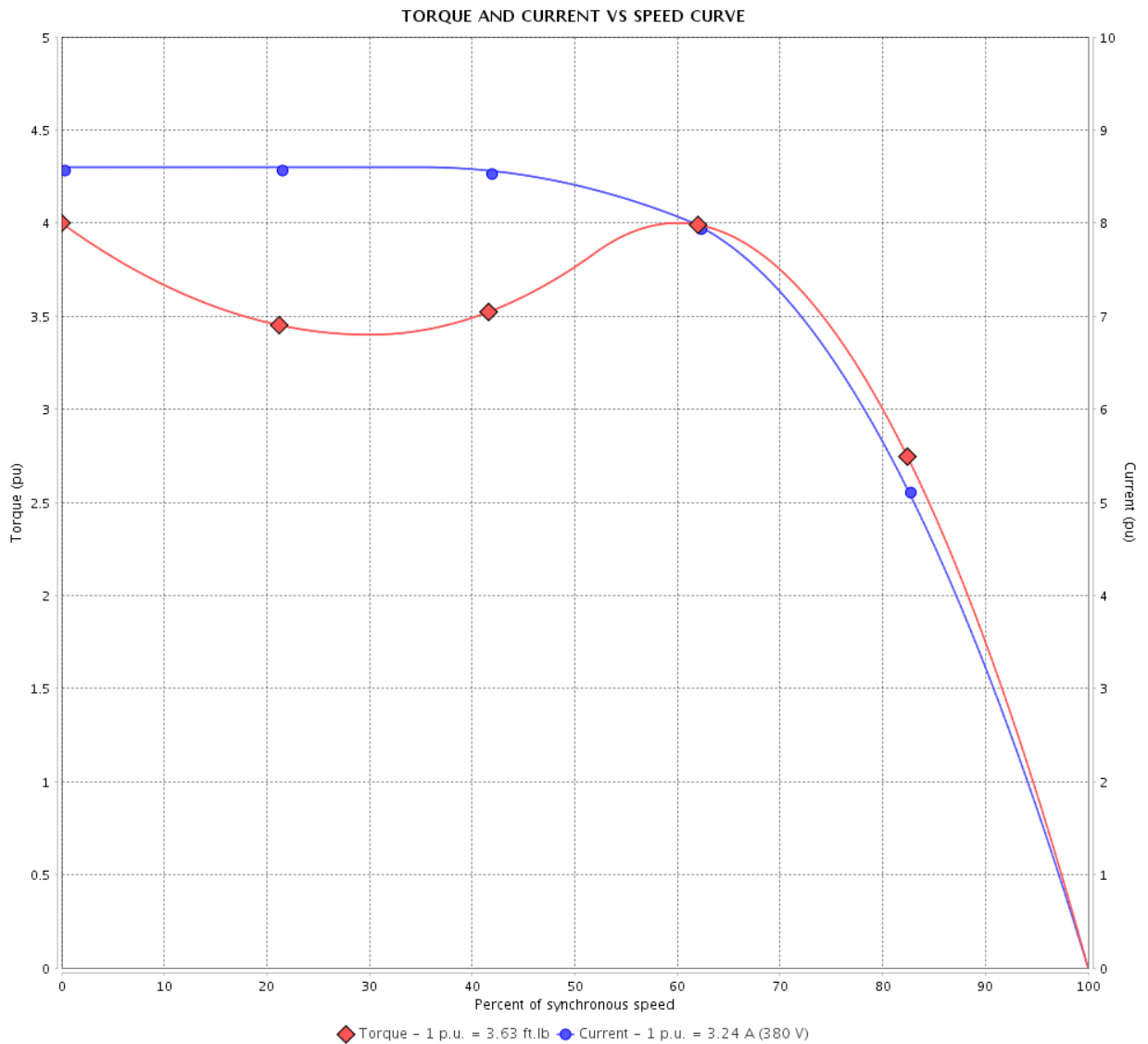

Performance : 380 V 50 Hz 2P IE3

Rated current	: 3.24 A	Moment of inertia (J)	: 0.0605 sq.ft.lb
LRC	: 8.6	Duty cycle	: Cont.(S1)
Rated torque	: 3.63 ft.lb	Insulation class	: F
Locked rotor torque	: 400 %	Service factor	: 1.25
Breakdown torque	: 400 %	Temperature rise	: 80 K
Rated speed	: 2890 rpm	Design	: B

Locked rotor time : 25s (cold) 14s (hot)

Rev.	Changes Summary	Performed	Checked	Date
Performed by			Page 3 / 36	Revision
Checked by				
Date	13/04/2022			

# TORQUE AND CURRENT VS SPEED CURVE

Three Phase Induction Motor - Squirrel Cage



Customer :

Product line : NEMA Premium Efficiency Three-Phase

Product code : 13468368

Catalog # : 00336ET3ER145TC-W22

TORQUE AND CURRENT VS SPEED CURVE

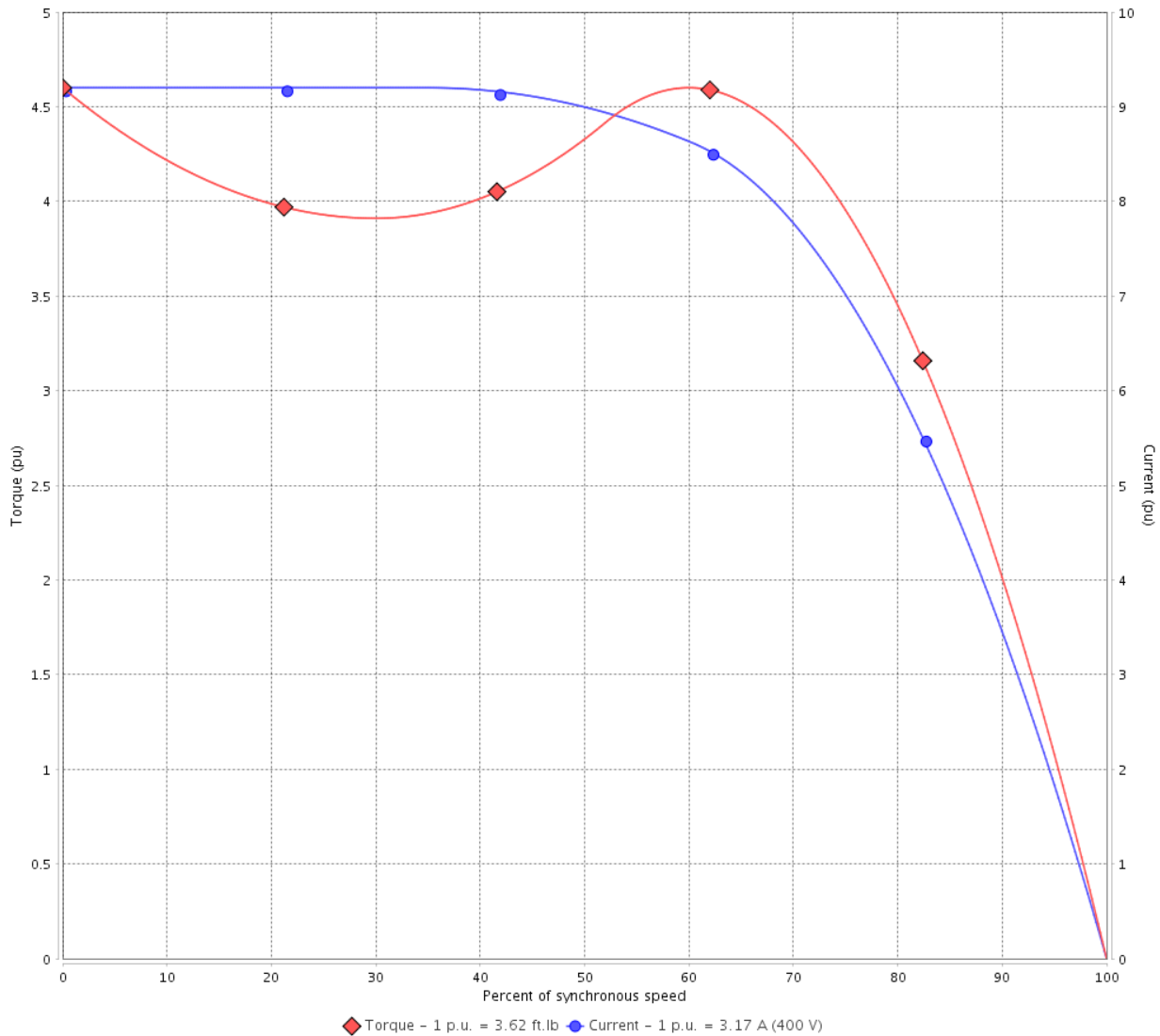

Performance : 400 V 50 Hz 2P IE3

Rated current	: 3.17 A	Moment of inertia (J)	: 0.0605 sq.ft.lb
LRC	: 9.2	Duty cycle	: Cont.(S1)
Rated torque	: 3.62 ft.lb	Insulation class	: F
Locked rotor torque	: 459 %	Service factor	: 1.00
Breakdown torque	: 459 %	Temperature rise	: 80 K
Rated speed	: 2905 rpm	Design	: B

Locked rotor time : 23s (cold) 13s (hot)

Rev.	Changes Summary	Performed	Checked	Date
Performed by			Page 4 / 36	Revision
Checked by				
Date	13/04/2022			

# TORQUE AND CURRENT VS SPEED CURVE



## Three Phase Induction Motor - Squirrel Cage

Customer :

Product line : NEMA Premium Efficiency Three-Phase  
 Product code : 13468368  
 Catalog # : 00336ET3ER145TC-W22

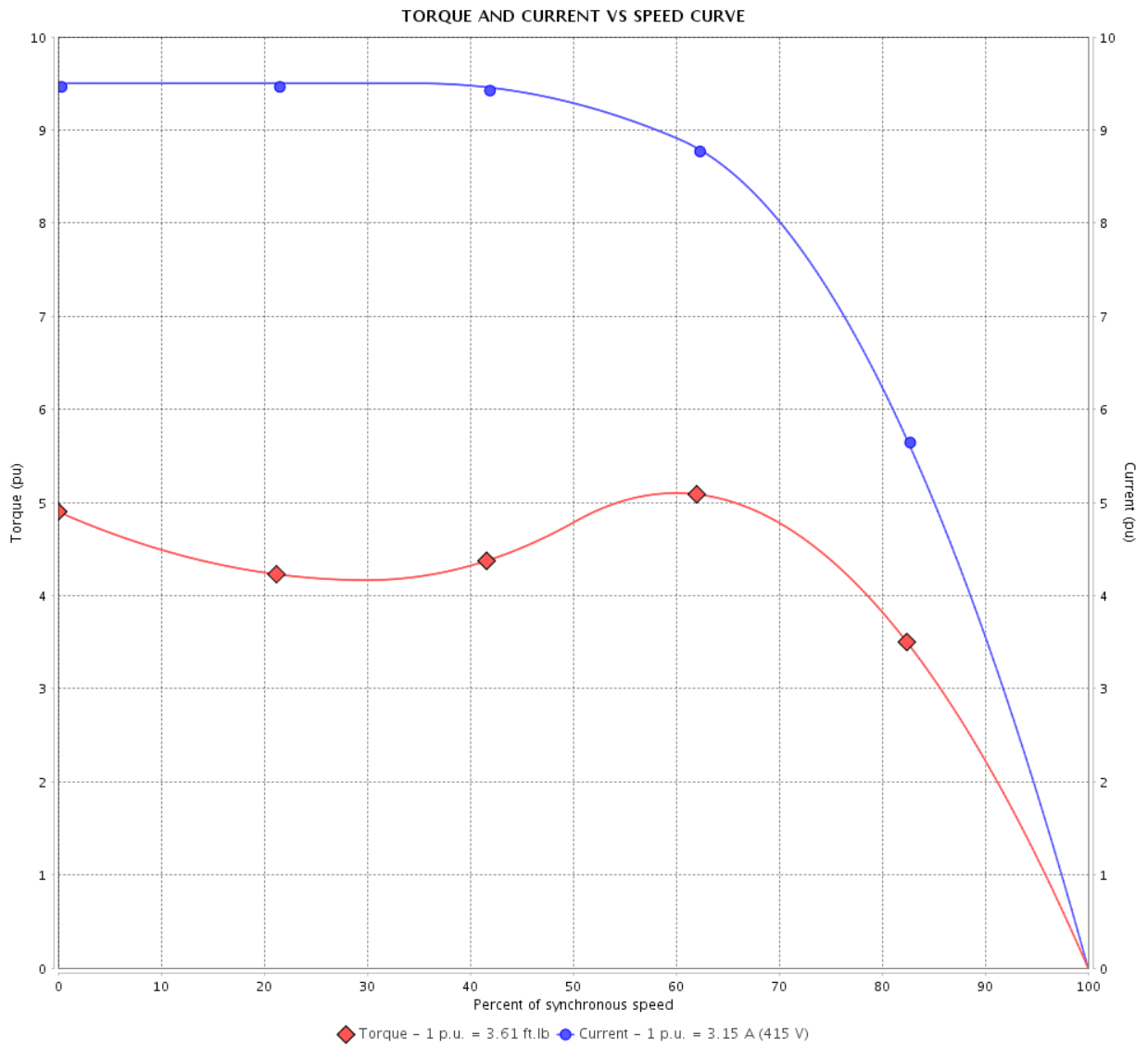

Performance : 415 V 50 Hz 2P IE3

Rated current : 3.15 A	Moment of inertia (J) : 0.0605 sq.ft.lb
LRC : 9.5	Duty cycle : Cont.(S1)
Rated torque : 3.61 ft.lb	Insulation class : F
Locked rotor torque : 490 %	Service factor : 1.00
Breakdown torque : 509 %	Temperature rise : 80 K
Rated speed : 2910 rpm	Design : B

Locked rotor time : 23s (cold) 13s (hot)

Rev.	Changes Summary	Performed	Checked	Date
Performed by			Page 5 / 36	Revision
Checked by				
Date	13/04/2022			

# TORQUE AND CURRENT VS SPEED CURVE

## Three Phase Induction Motor - Squirrel Cage



Customer :

Product line : NEMA Premium Efficiency Three-Phase

Product code : 13468368

Catalog # : 00336ET3ER145TC-W22

TORQUE AND CURRENT VS SPEED CURVE

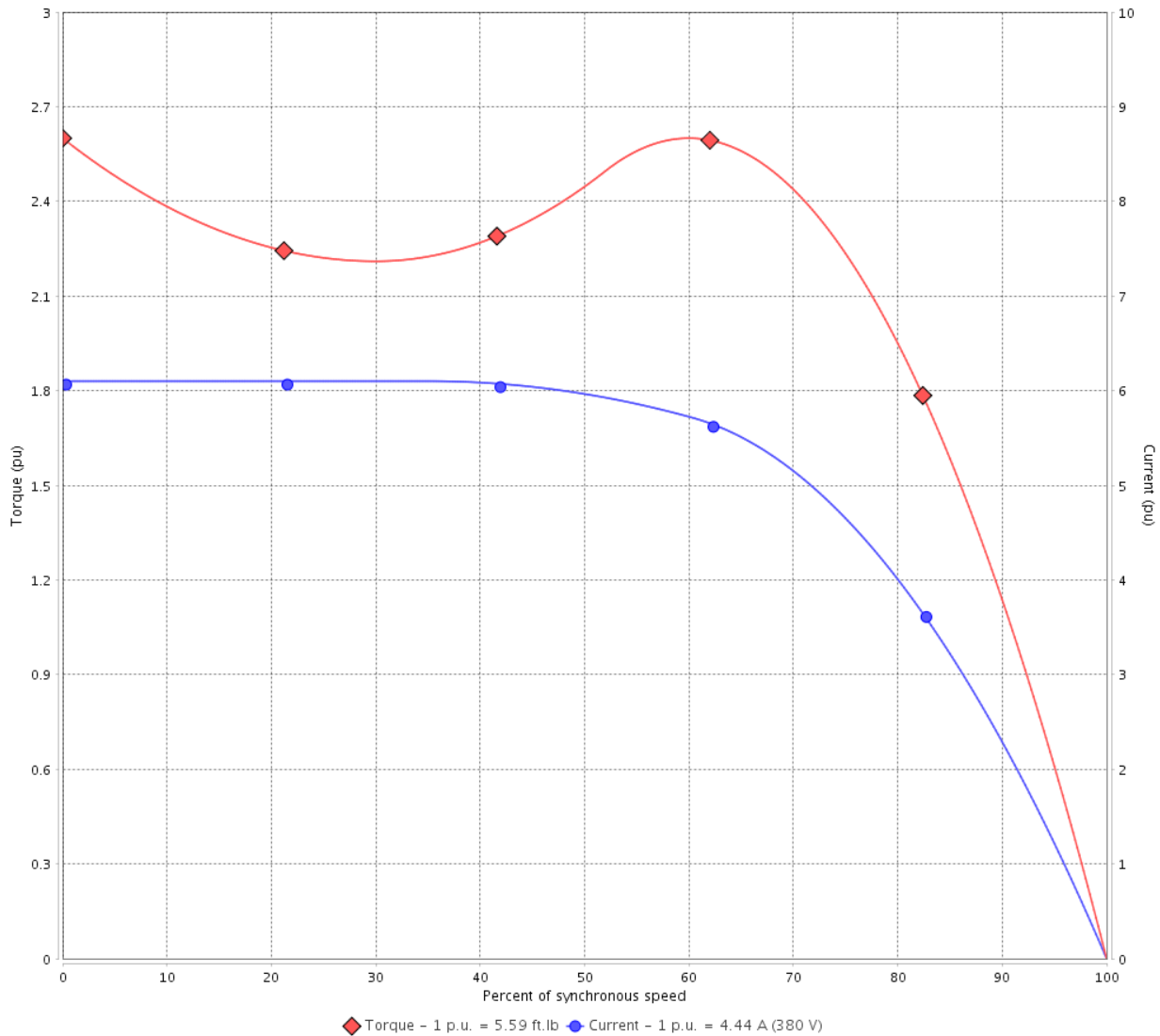

Performance : 380 V 50 Hz 2P IE2

Rated current	: 4.44 A	Moment of inertia (J)	: 0.0605 sq.ft.lb
LRC	: 6.1	Duty cycle	: Cont.(S1)
Rated torque	: 5.59 ft.lb	Insulation class	: F
Locked rotor torque	: 260 %	Service factor	: 1.25
Breakdown torque	: 260 %	Temperature rise	: 80 K
Rated speed	: 2820 rpm	Design	: B

Locked rotor time : 25s (cold) 14s (hot)

Rev.	Changes Summary	Performed	Checked	Date
Performed by			Page 6 / 36	Revision
Checked by				
Date	13/04/2022			

# TORQUE AND CURRENT VS SPEED CURVE



## Three Phase Induction Motor - Squirrel Cage

Customer :

Product line : NEMA Premium Efficiency Three-Phase

Product code : 13468368

Catalog # : 00336ET3ER145TC-W22

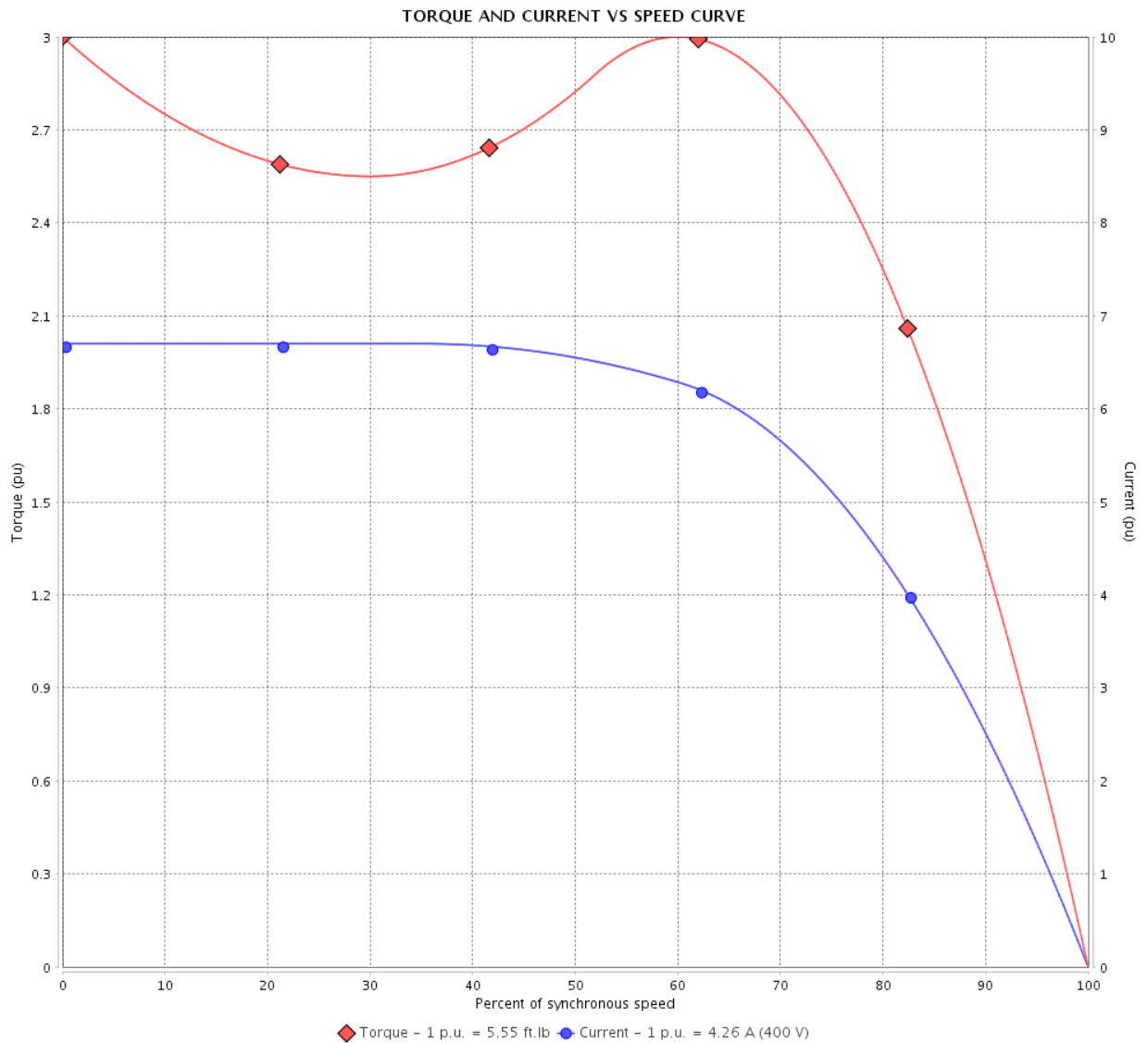

Performance : 400 V 50 Hz 2P IE2

Rated current	: 4.26 A	Moment of inertia (J)	: 0.0605 sq.ft.lb
LRC	: 6.7	Duty cycle	: Cont.(S1)
Rated torque	: 5.55 ft.lb	Insulation class	: F
Locked rotor torque	: 300 %	Service factor	: 1.00
Breakdown torque	: 300 %	Temperature rise	: 80 K
Rated speed	: 2840 rpm	Design	: B

Locked rotor time : 23s (cold) 13s (hot)

Rev.	Changes Summary	Performed	Checked	Date
Performed by			Page 7 / 36	Revision
Checked by				
Date	13/04/2022			

# TORQUE AND CURRENT VS SPEED CURVE

Three Phase Induction Motor - Squirrel Cage



Customer :

Product line : NEMA Premium Efficiency Three-Phase

Product code : 13468368

Catalog # : 00336ET3ER145TC-W22

TORQUE AND CURRENT VS SPEED CURVE

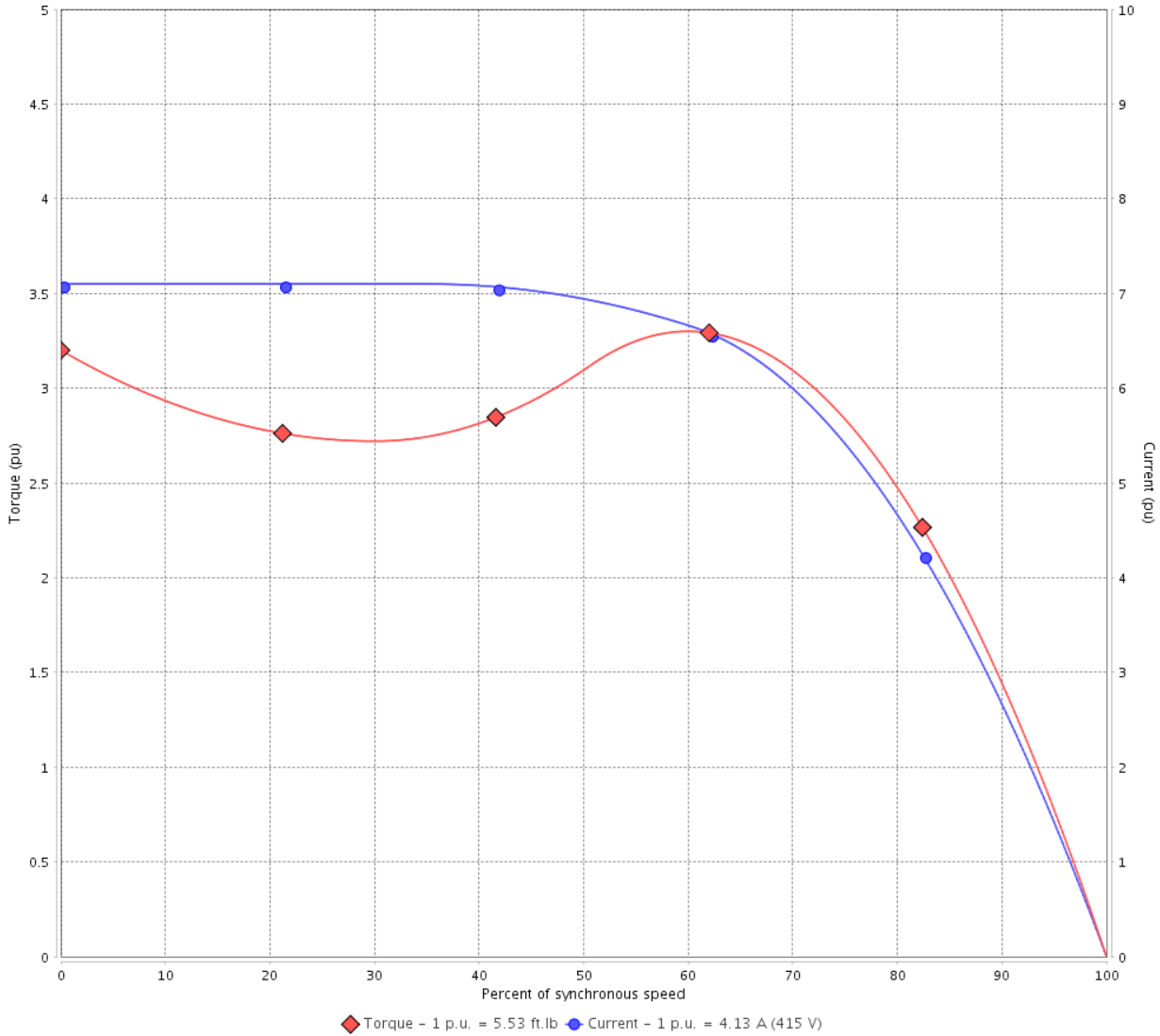

Performance : 415 V 50 Hz 2P IE3

Rated current	: 4.13 A	Moment of inertia (J)	: 0.0605 sq.ft.lb
LRC	: 7.1	Duty cycle	: Cont.(S1)
Rated torque	: 5.53 ft.lb	Insulation class	: F
Locked rotor torque	: 320 %	Service factor	: 1.00
Breakdown torque	: 330 %	Temperature rise	: 80 K
Rated speed	: 2850 rpm	Design	: B

Locked rotor time : 23s (cold) 13s (hot)

Rev.	Changes Summary	Performed	Checked	Date
Performed by			Page 8 / 36	Revision
Checked by				
Date	13/04/2022			



# LOAD PERFORMANCE CURVE

## Three Phase Induction Motor - Squirrel Cage



Customer :

Product line : NEMA Premium Efficiency Three-Phase

Product code : 13468368

Catalog # : 00336ET3ER145TC-W22

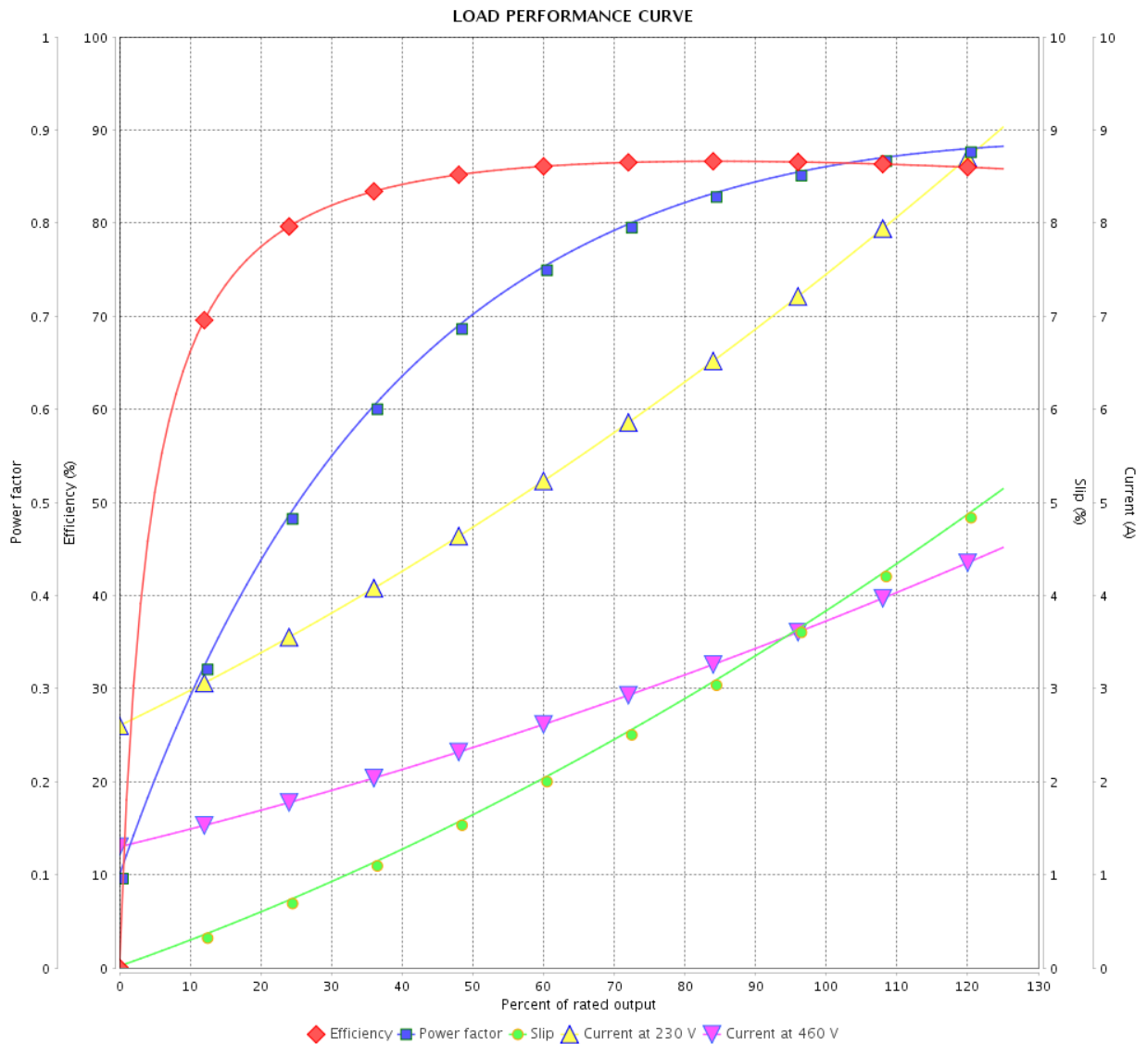

Performance : 230/460 V 60 Hz 2P

Rated current : 7.42/3.71 A  
 LRC : 8.1  
 Rated torque : 4.55 ft.lb  
 Locked rotor torque : 330 %  
 Breakdown torque : 360 %  
 Rated speed : 3460 rpm

Moment of inertia (J) : 0.0605 sq.ft.lb  
 Duty cycle : Cont.(S1)  
 Insulation class : F  
 Service factor : 1.25  
 Temperature rise : 80 K  
 Design : B

Rev.	Changes Summary	Performed	Checked	Date
Performed by			Page	Revision
Checked by			9 / 36	
Date	13/04/2022			

# LOAD PERFORMANCE CURVE

Three Phase Induction Motor - Squirrel Cage



Customer :

Product line : NEMA Premium Efficiency Three-Phase

Product code : 13468368

Catalog # : 00336ET3ER145TC-W22

LOAD PERFORMANCE CURVE

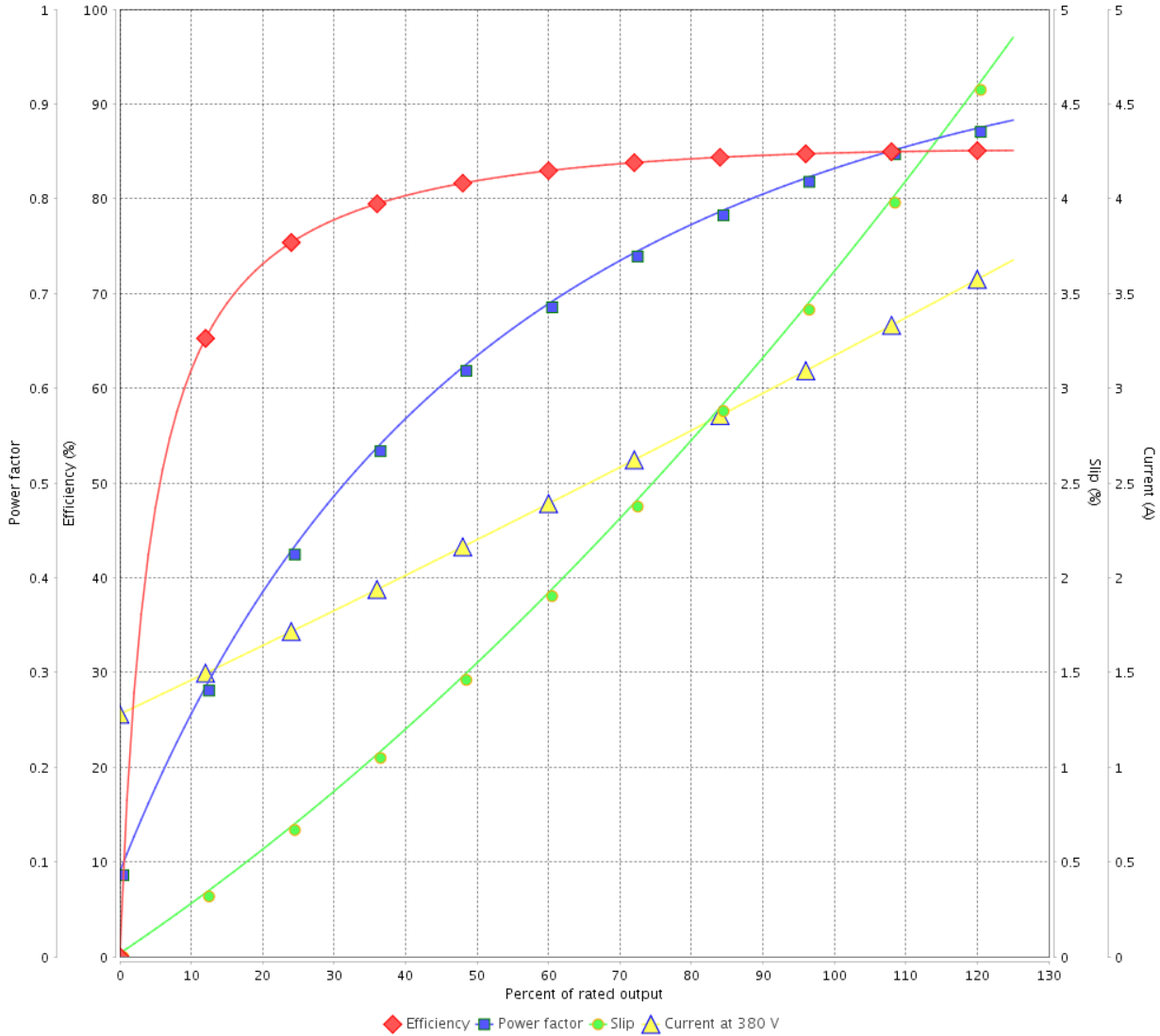

Performance : 380 V 50 Hz 2P IE3

Rated current : 3.24 A  
 LRC : 8.6  
 Rated torque : 3.63 ft.lb  
 Locked rotor torque : 400 %  
 Breakdown torque : 400 %  
 Rated speed : 2890 rpm

Moment of inertia (J) : 0.0605 sq.ft.lb  
 Duty cycle : Cont.(S1)  
 Insulation class : F  
 Service factor : 1.25  
 Temperature rise : 80 K  
 Design : B

Rev.	Changes Summary	Performed	Checked	Date
Performed by			Page	Revision
Checked by			10 / 36	
Date	13/04/2022			

# LOAD PERFORMANCE CURVE

## Three Phase Induction Motor - Squirrel Cage



Customer : \_\_\_\_\_

Product line : NEMA Premium Efficiency Three-Phase

Product code : 13468368

Catalog # : 00336ET3ER145TC-W22

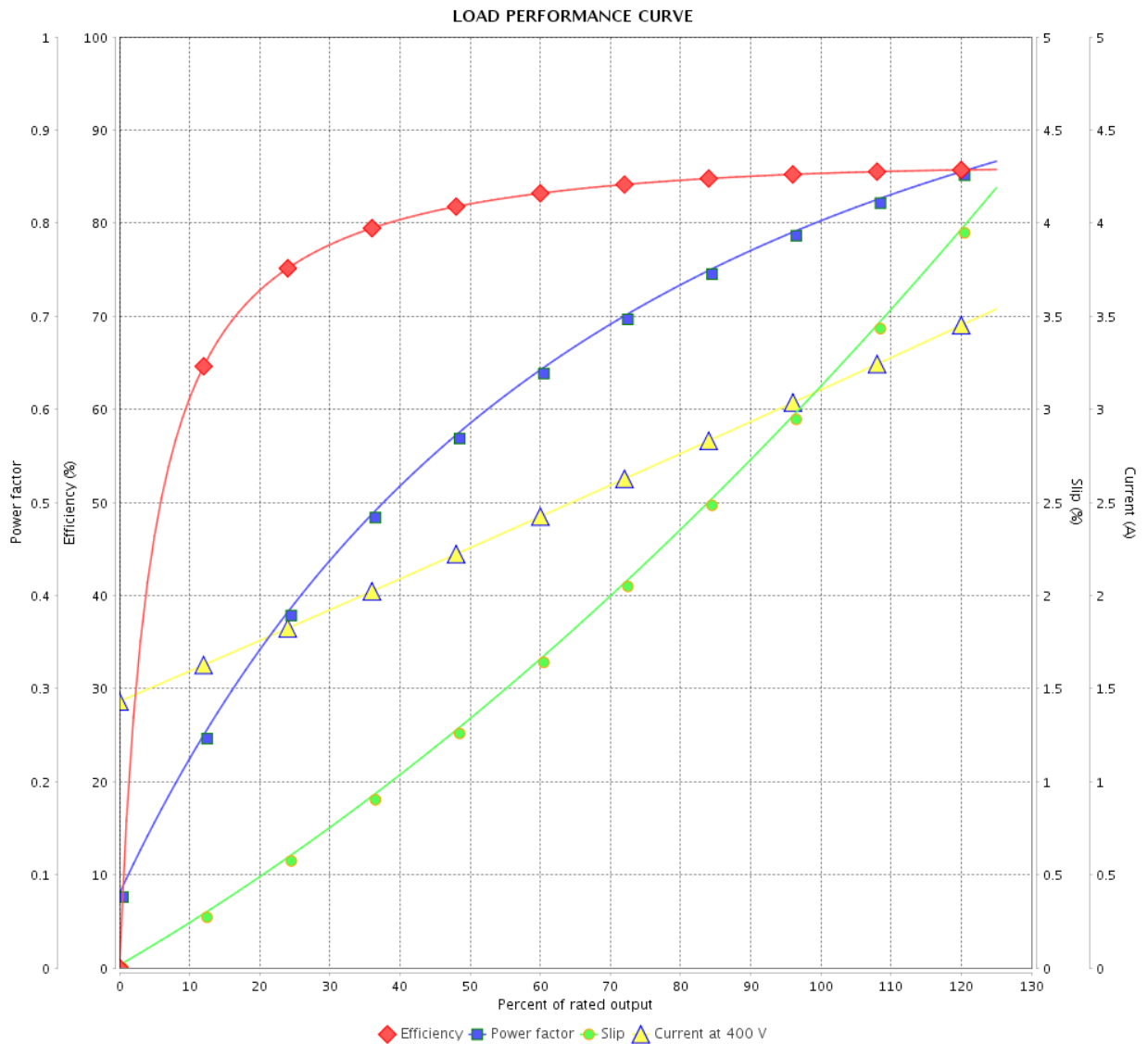

Performance : 400 V 50 Hz 2P IE3

Rated current : 3.17 A  
 LRC : 9.2  
 Rated torque : 3.62 ft.lb  
 Locked rotor torque : 459 %  
 Breakdown torque : 459 %  
 Rated speed : 2905 rpm

Moment of inertia (J) : 0.0605 sq.ft.lb  
 Duty cycle : Cont.(S1)  
 Insulation class : F  
 Service factor : 1.00  
 Temperature rise : 80 K  
 Design : B

Rev.	Changes Summary	Performed	Checked	Date
Performed by		Page		Revision
Checked by		11 / 36		
Date		13/04/2022		

# LOAD PERFORMANCE CURVE

Three Phase Induction Motor - Squirrel Cage



Customer :

Product line : NEMA Premium Efficiency Three-Phase

Product code : 13468368

Catalog # : 00336ET3ER145TC-W22

LOAD PERFORMANCE CURVE

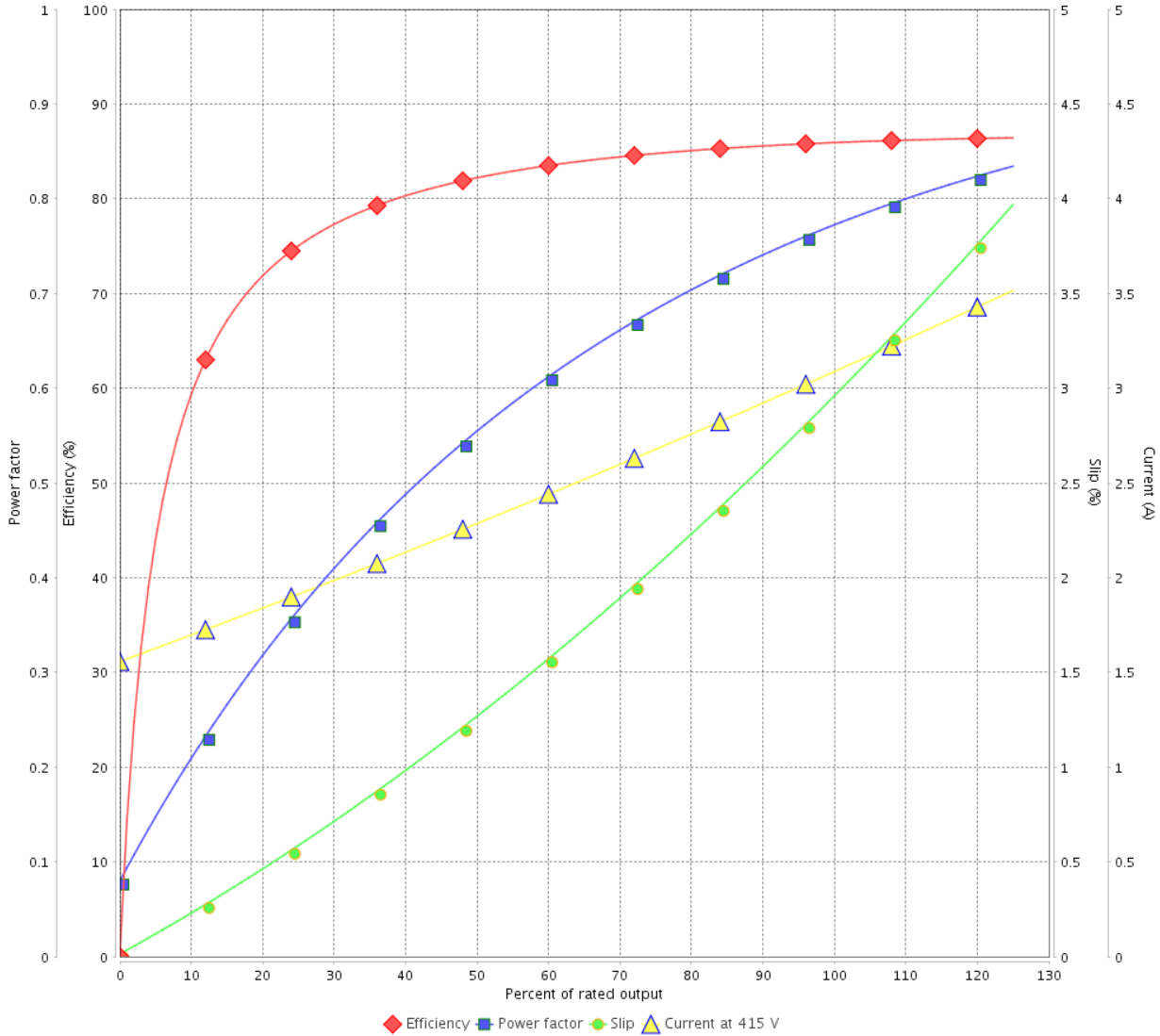

Performance : 415 V 50 Hz 2P IE3

Rated current : 3.15 A  
 LRC : 9.5  
 Rated torque : 3.61 ft.lb  
 Locked rotor torque : 490 %  
 Breakdown torque : 509 %  
 Rated speed : 2910 rpm

Moment of inertia (J) : 0.0605 sq.ft.lb  
 Duty cycle : Cont.(S1)  
 Insulation class : F  
 Service factor : 1.00  
 Temperature rise : 80 K  
 Design : B

Rev.	Changes Summary	Performed	Checked	Date
Performed by			Page 12 / 36	Revision
Checked by				
Date	13/04/2022			

# LOAD PERFORMANCE CURVE

## Three Phase Induction Motor - Squirrel Cage



Customer : \_\_\_\_\_

Product line : NEMA Premium Efficiency Three-Phase

Product code : 13468368

Catalog # : 00336ET3ER145TC-W22

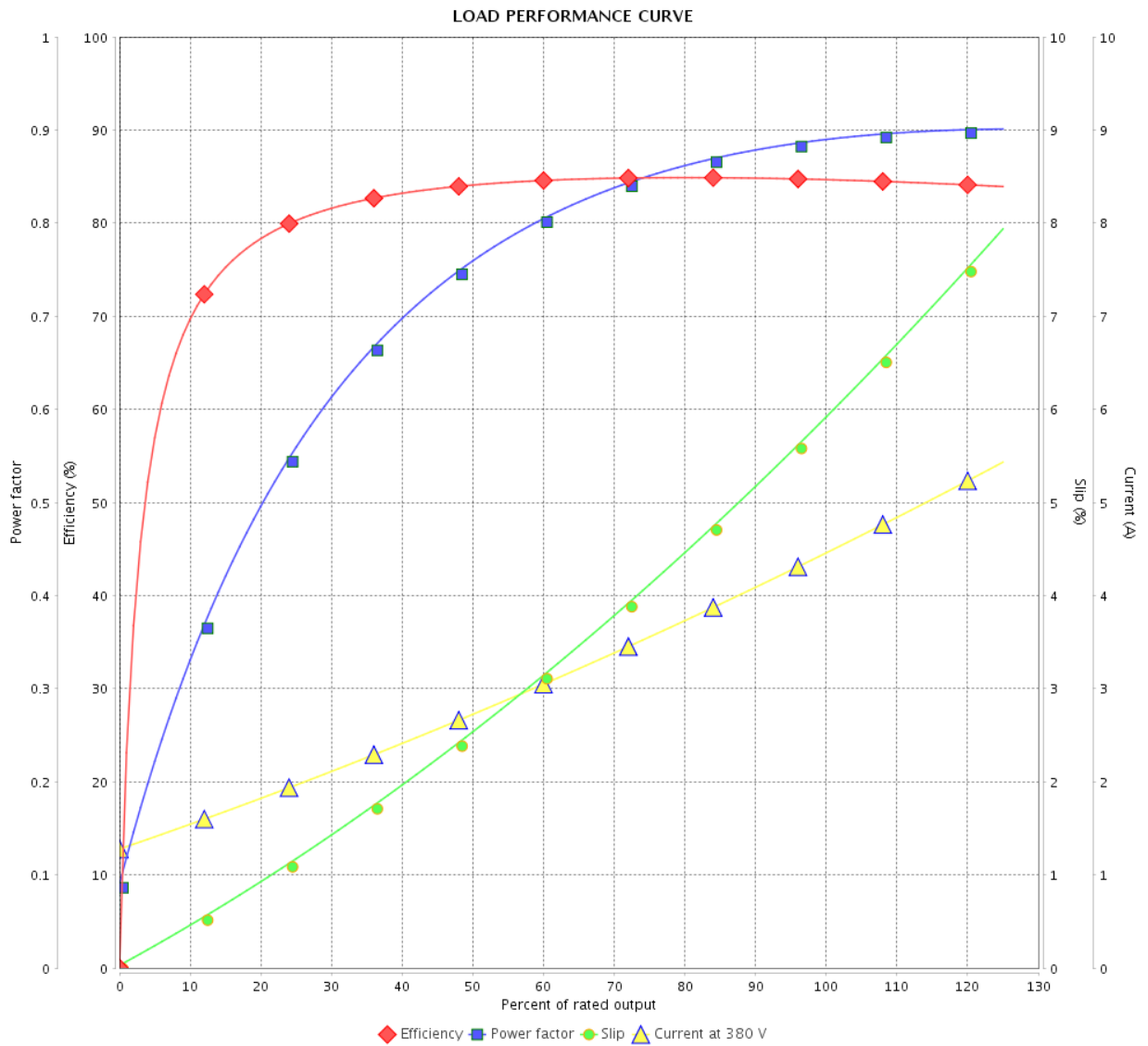

Performance : 380 V 50 Hz 2P IE2

Rated current : 4.44 A  
 LRC : 6.1  
 Rated torque : 5.59 ft.lb  
 Locked rotor torque : 260 %  
 Breakdown torque : 260 %  
 Rated speed : 2820 rpm

Moment of inertia (J) : 0.0605 sq.ft.lb  
 Duty cycle : Cont.(S1)  
 Insulation class : F  
 Service factor : 1.25  
 Temperature rise : 80 K  
 Design : B

Rev.	Changes Summary	Performed	Checked	Date
Performed by		Page		Revision
Checked by		13 / 36		
Date		13/04/2022		

# LOAD PERFORMANCE CURVE

Three Phase Induction Motor - Squirrel Cage



Customer :

Product line : NEMA Premium Efficiency Three-Phase

Product code : 13468368

Catalog # : 00336ET3ER145TC-W22

LOAD PERFORMANCE CURVE

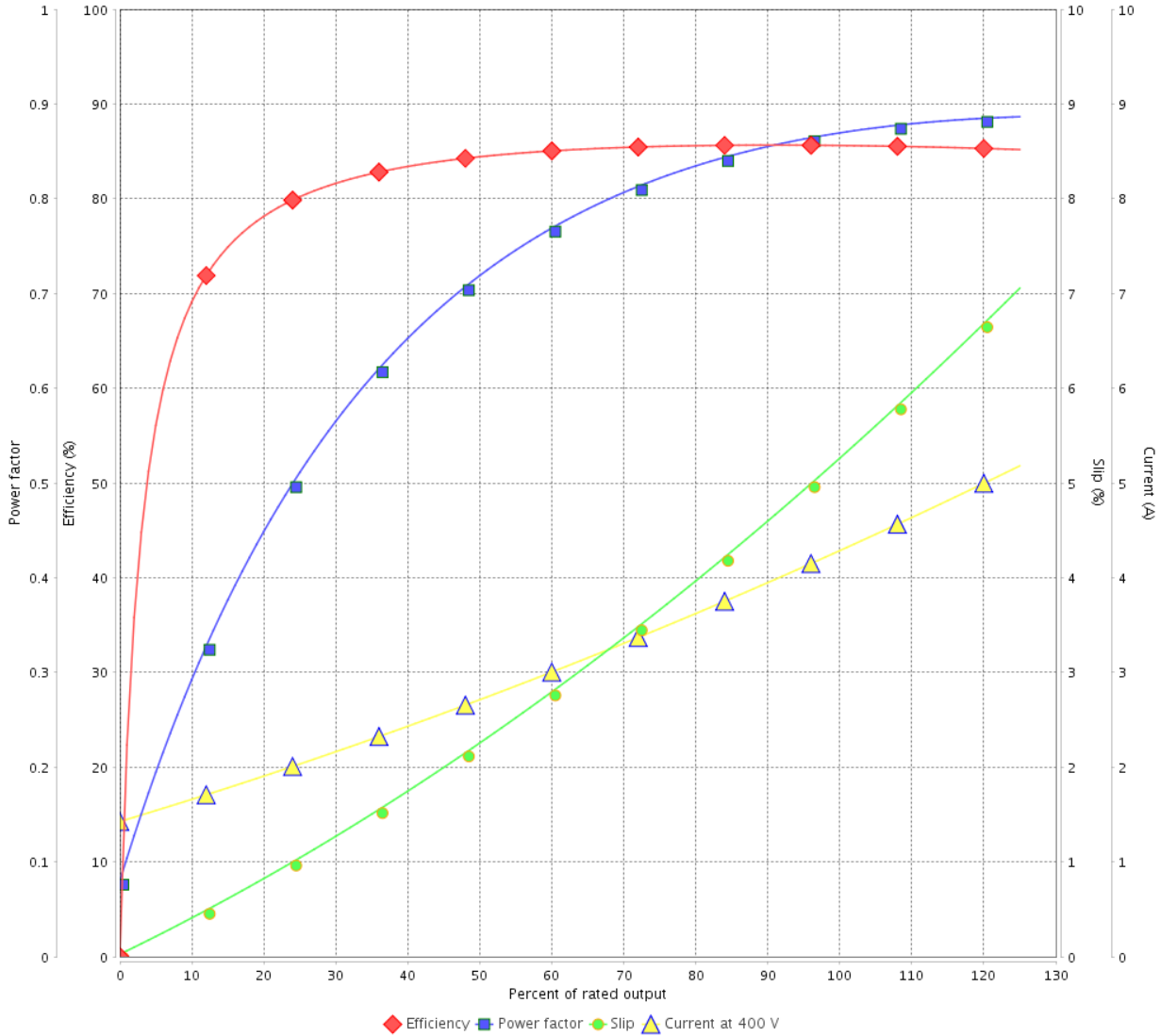

Performance : 400 V 50 Hz 2P IE2

Rated current : 4.26 A  
 LRC : 6.7  
 Rated torque : 5.55 ft.lb  
 Locked rotor torque : 300 %  
 Breakdown torque : 300 %  
 Rated speed : 2840 rpm

Moment of inertia (J) : 0.0605 sq.ft.lb  
 Duty cycle : Cont.(S1)  
 Insulation class : F  
 Service factor : 1.00  
 Temperature rise : 80 K  
 Design : B

Rev.	Changes Summary	Performed	Checked	Date
Performed by			Page	Revision
Checked by			14 / 36	
Date	13/04/2022			

# LOAD PERFORMANCE CURVE

## Three Phase Induction Motor - Squirrel Cage



Customer : \_\_\_\_\_

Product line : NEMA Premium Efficiency Three-Phase

Product code : 13468368

Catalog # : 00336ET3ER145TC-W22

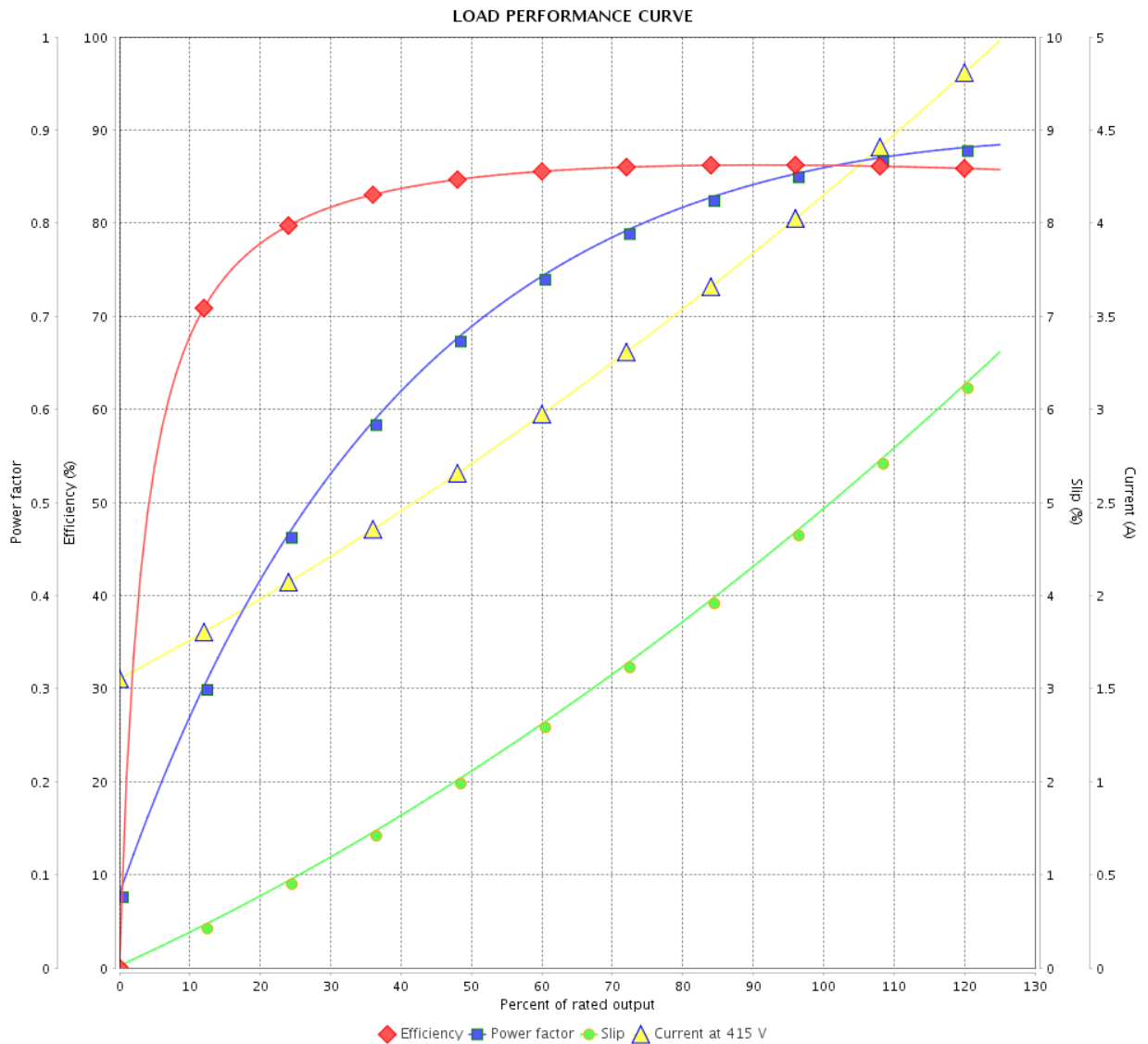

Performance : 415 V 50 Hz 2P IE3

Rated current : 4.13 A  
 LRC : 7.1  
 Rated torque : 5.53 ft.lb  
 Locked rotor torque : 320 %  
 Breakdown torque : 330 %  
 Rated speed : 2850 rpm

Moment of inertia (J) : 0.0605 sq.ft.lb  
 Duty cycle : Cont.(S1)  
 Insulation class : F  
 Service factor : 1.00  
 Temperature rise : 80 K  
 Design : B

Rev.	Changes Summary	Performed	Checked	Date
Performed by		Page		Revision
Checked by		15 / 36		
Date		13/04/2022		

# THERMAL LIMIT CURVE



## Three Phase Induction Motor - Squirrel Cage

Customer :

Product line : NEMA Premium Efficiency Three-Phase  
Product code : 13468368  
Catalog # : 00336ET3ER145TC-W22

Performance : 230/460 V 60 Hz 2P

Rated current	: 7.42/3.71 A	Moment of inertia (J)	: 0.0605 sq.ft.lb
LRC	: 8.1	Duty cycle	: Cont.(S1)
Rated torque	: 4.55 ft.lb	Insulation class	: F
Locked rotor torque	: 330 %	Service factor	: 1.25
Breakdown torque	: 360 %	Temperature rise	: 80 K
Rated speed	: 3460 rpm	Design	: B

Heating constant

Cooling constant

Rev.	Changes Summary	Performed	Checked	Date
Performed by				
Checked by			Page	Revision
Date	13/04/2022		16 / 36	



# THERMAL LIMIT CURVE

Three Phase Induction Motor - Squirrel Cage



Customer : \_\_\_\_\_

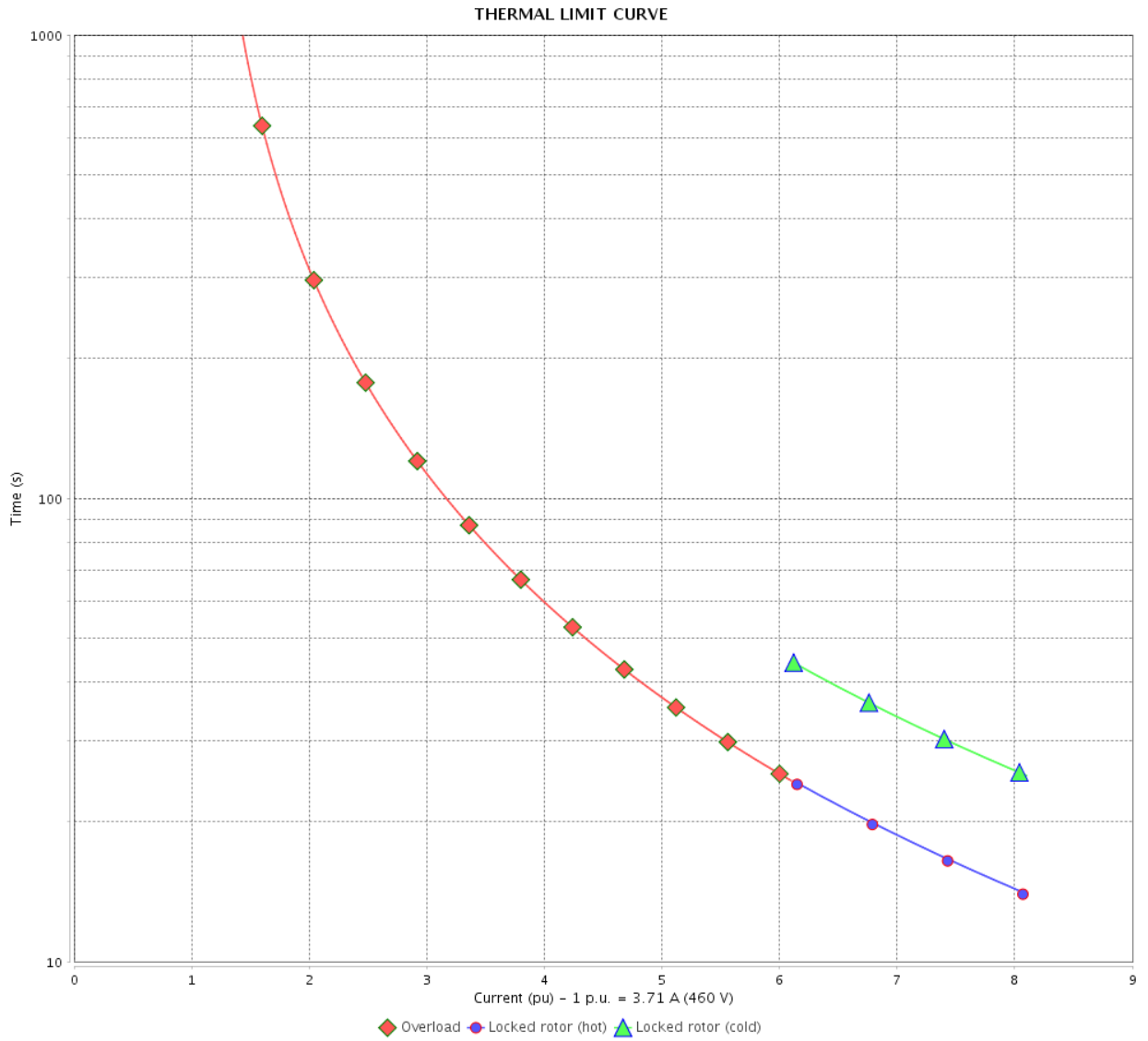

Rev.	Changes Summary	Performed	Checked	Date
Performed by		Page		Revision
Checked by		17 / 36		
Date		13/04/2022		

# THERMAL LIMIT CURVE



## Three Phase Induction Motor - Squirrel Cage

Customer :

Product line : NEMA Premium Efficiency Three-Phase  
 Product code : 13468368  
 Catalog # : 00336ET3ER145TC-W22

Performance : 380 V 50 Hz 2P IE3

Rated current : 3.24 A	Moment of inertia (J) : 0.0605 sq.ft.lb
LRC : 8.6	Duty cycle : Cont.(S1)
Rated torque : 3.63 ft.lb	Insulation class : F
Locked rotor torque : 400 %	Service factor : 1.25
Breakdown torque : 400 %	Temperature rise : 80 K
Rated speed : 2890 rpm	Design : B

Heating constant

Cooling constant

Rev.	Changes Summary	Performed	Checked	Date
Performed by			Page 18 / 36	Revision
Checked by				
Date	13/04/2022			

# THERMAL LIMIT CURVE

Three Phase Induction Motor - Squirrel Cage



Customer : \_\_\_\_\_

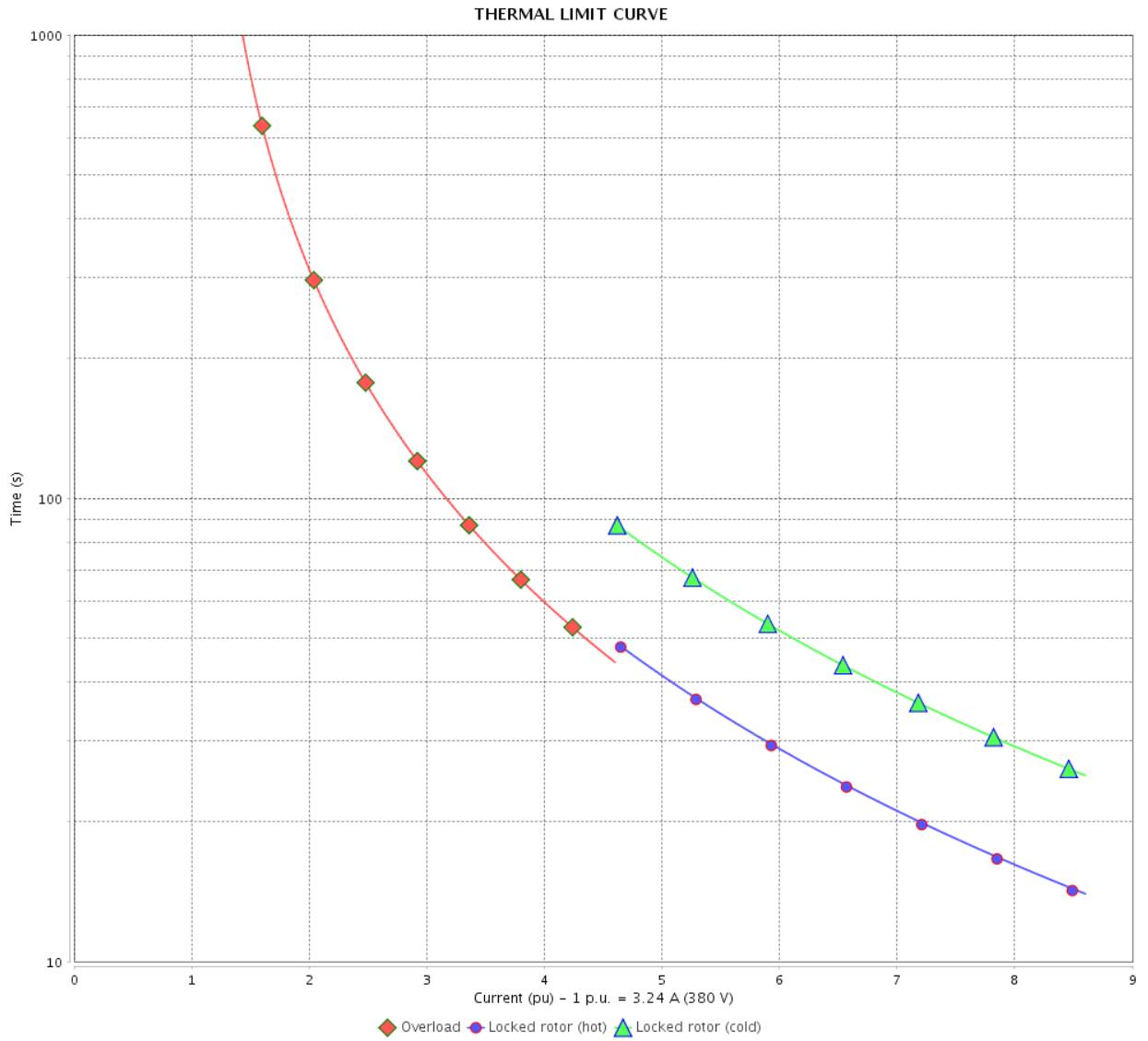

Rev.	Changes Summary	Performed	Checked	Date
Performed by		Page		Revision
Checked by		19 / 36		
Date		13/04/2022		

# THERMAL LIMIT CURVE



## Three Phase Induction Motor - Squirrel Cage

Customer :

Product line : NEMA Premium Efficiency Three-Phase  
Product code : 13468368  
Catalog # : 00336ET3ER145TC-W22

Performance : 400 V 50 Hz 2P IE3

Rated current	: 3.17 A	Moment of inertia (J)	: 0.0605 sq.ft.lb
LRC	: 9.2	Duty cycle	: Cont.(S1)
Rated torque	: 3.62 ft.lb	Insulation class	: F
Locked rotor torque	: 459 %	Service factor	: 1.00
Breakdown torque	: 459 %	Temperature rise	: 80 K
Rated speed	: 2905 rpm	Design	: B

Heating constant

Cooling constant

Rev.	Changes Summary	Performed	Checked	Date
Performed by				
Checked by			Page	Revision
Date	13/04/2022		20 / 36	

# THERMAL LIMIT CURVE

Three Phase Induction Motor - Squirrel Cage



Customer : \_\_\_\_\_

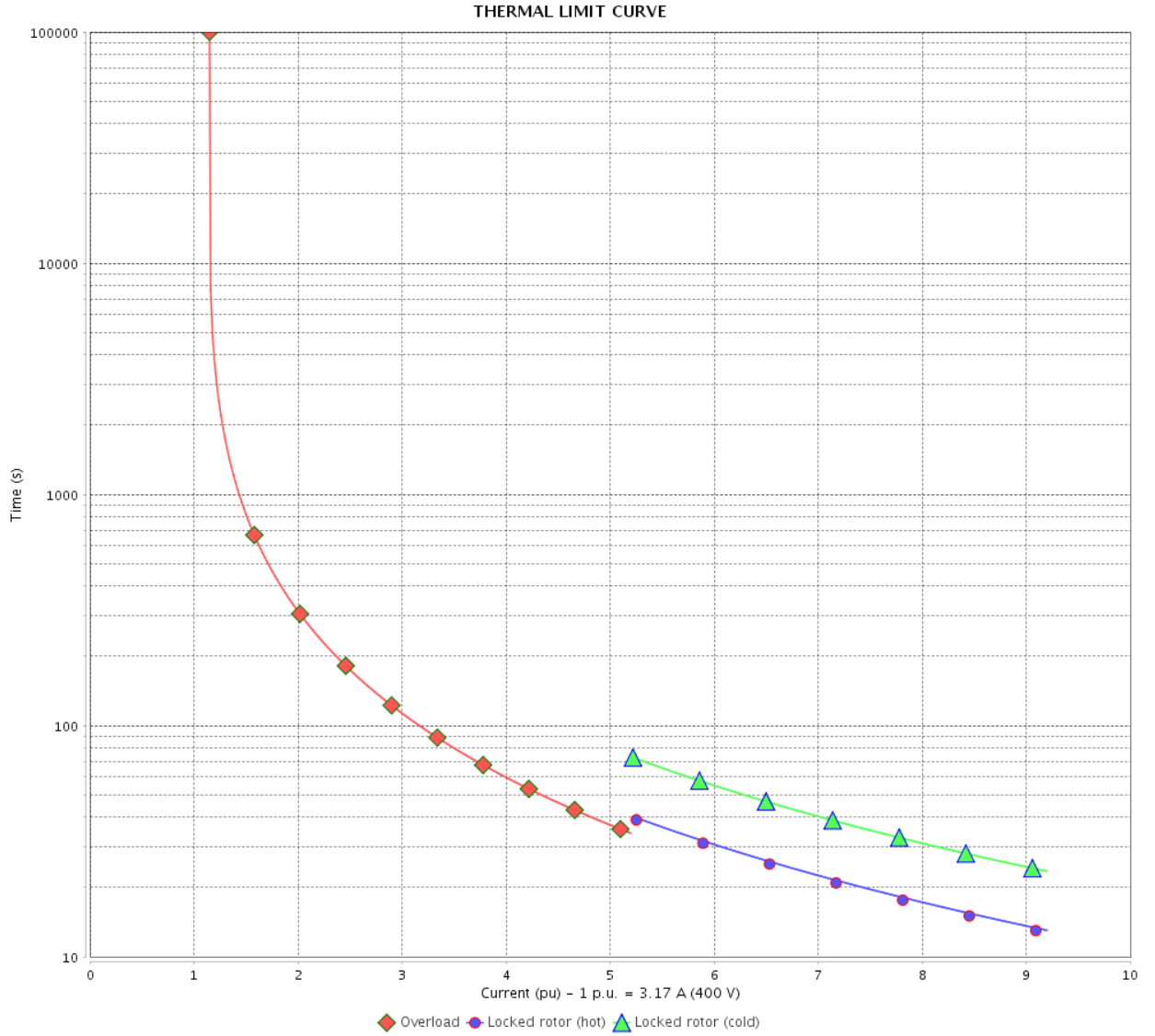

Rev.	Changes Summary	Performed	Checked	Date
Performed by		Page		Revision
Checked by		21 / 36		
Date		13/04/2022		

# THERMAL LIMIT CURVE



## Three Phase Induction Motor - Squirrel Cage

Customer :

Product line : NEMA Premium Efficiency Three-Phase  
Product code : 13468368  
Catalog # : 00336ET3ER145TC-W22

Performance : 415 V 50 Hz 2P IE3

Rated current	: 3.15 A	Moment of inertia (J)	: 0.0605 sq.ft.lb
LRC	: 9.5	Duty cycle	: Cont.(S1)
Rated torque	: 3.61 ft.lb	Insulation class	: F
Locked rotor torque	: 490 %	Service factor	: 1.00
Breakdown torque	: 509 %	Temperature rise	: 80 K
Rated speed	: 2910 rpm	Design	: B

Heating constant

Cooling constant

Rev.	Changes Summary	Performed	Checked	Date
Performed by				
Checked by			Page	Revision
Date	13/04/2022		22 / 36	

# THERMAL LIMIT CURVE

Three Phase Induction Motor - Squirrel Cage



Customer : \_\_\_\_\_

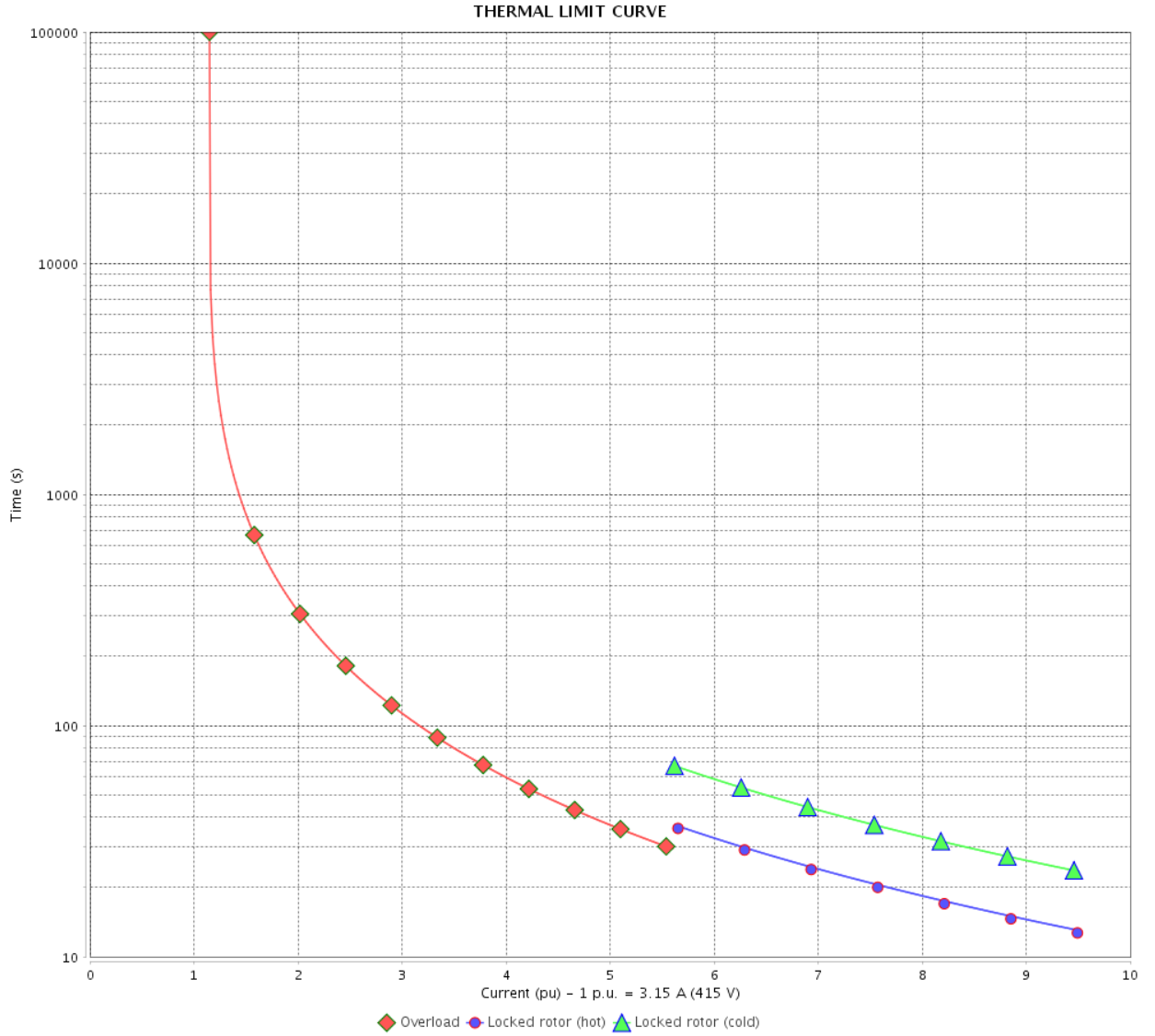

Rev.	Changes Summary	Performed	Checked	Date
Performed by		Page		Revision
Checked by		23 / 36		
Date		13/04/2022		

# THERMAL LIMIT CURVE



## Three Phase Induction Motor - Squirrel Cage

Customer :

Product line : NEMA Premium Efficiency Three-Phase  
Product code : 13468368  
Catalog # : 00336ET3ER145TC-W22

Performance : 380 V 50 Hz 2P IE2

Rated current	: 4.44 A	Moment of inertia (J)	: 0.0605 sq.ft.lb
LRC	: 6.1	Duty cycle	: Cont.(S1)
Rated torque	: 5.59 ft.lb	Insulation class	: F
Locked rotor torque	: 260 %	Service factor	: 1.25
Breakdown torque	: 260 %	Temperature rise	: 80 K
Rated speed	: 2820 rpm	Design	: B

Heating constant

Cooling constant

Rev.	Changes Summary	Performed	Checked	Date
Performed by				
Checked by			Page	Revision
Date	13/04/2022		24 / 36	



# THERMAL LIMIT CURVE

Three Phase Induction Motor - Squirrel Cage



Customer : \_\_\_\_\_

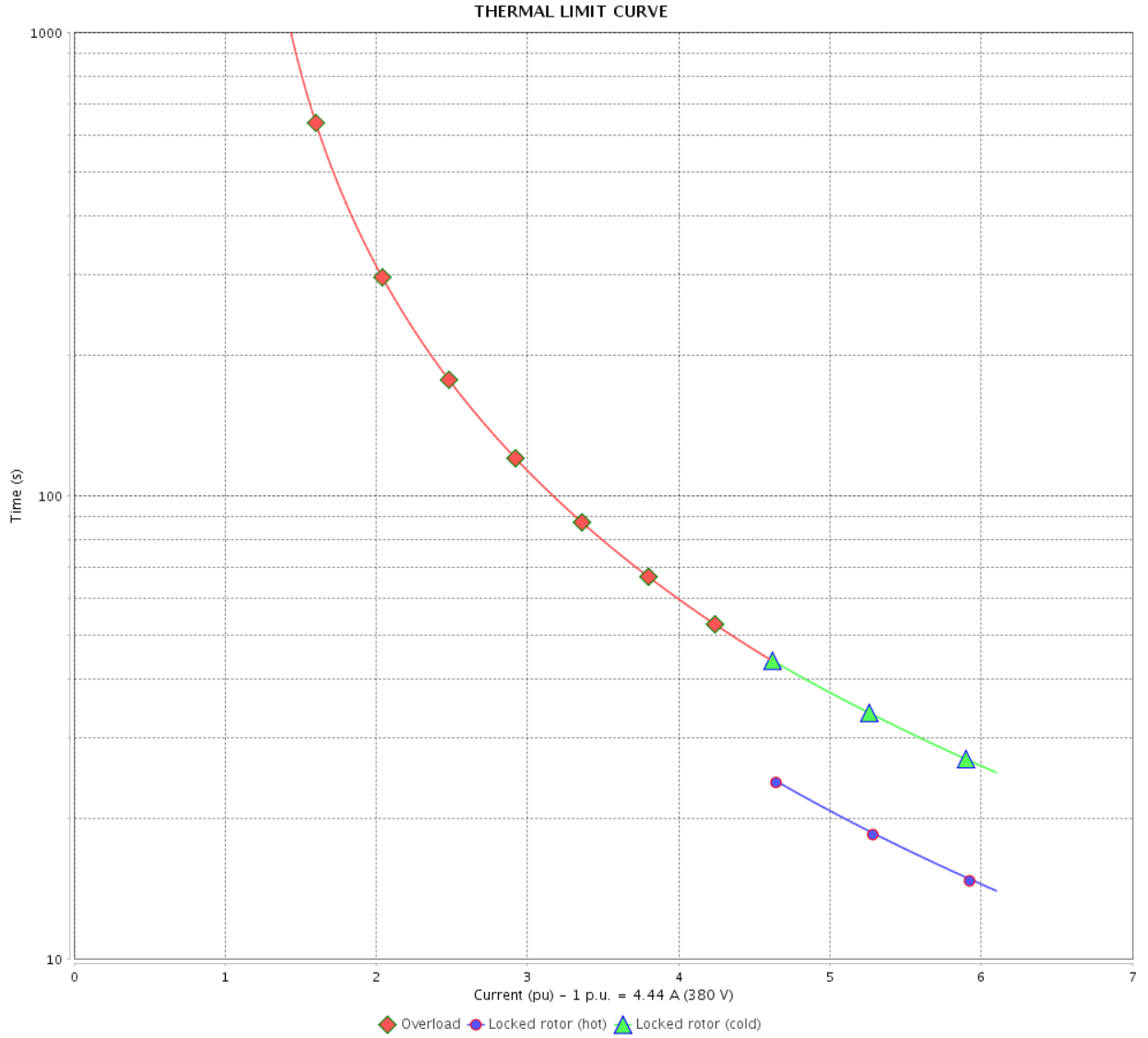

Rev.	Changes Summary	Performed	Checked	Date
Performed by		Page		Revision
Checked by		25 / 36		
Date		13/04/2022		

# THERMAL LIMIT CURVE



## Three Phase Induction Motor - Squirrel Cage

Customer :

Product line : NEMA Premium Efficiency Three-Phase  
 Product code : 13468368  
 Catalog # : 00336ET3ER145TC-W22

Performance : 400 V 50 Hz 2P IE2

Rated current : 4.26 A	Moment of inertia (J) : 0.0605 sq.ft.lb
LRC : 6.7	Duty cycle : Cont.(S1)
Rated torque : 5.55 ft.lb	Insulation class : F
Locked rotor torque : 300 %	Service factor : 1.00
Breakdown torque : 300 %	Temperature rise : 80 K
Rated speed : 2840 rpm	Design : B

Heating constant

Cooling constant

Rev.	Changes Summary	Performed	Checked	Date
Performed by			Page 26 / 36	Revision
Checked by				
Date	13/04/2022			

# THERMAL LIMIT CURVE

Three Phase Induction Motor - Squirrel Cage



Customer : \_\_\_\_\_

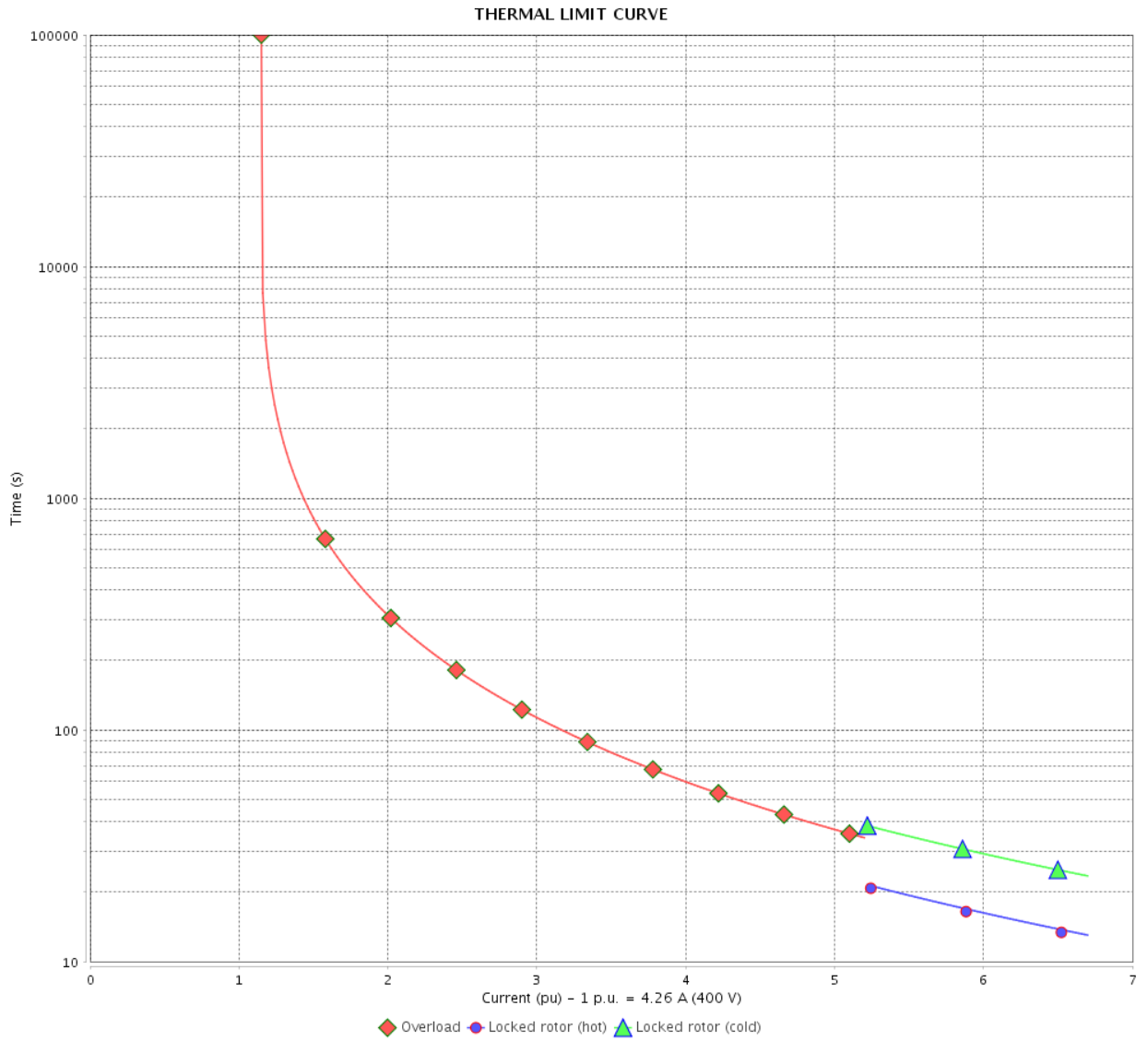

Rev.	Changes Summary	Performed	Checked	Date
Performed by		Page		Revision
Checked by		27 / 36		
Date		13/04/2022		

# THERMAL LIMIT CURVE

## Three Phase Induction Motor - Squirrel Cage



Customer :

Product line : NEMA Premium Efficiency Three-Phase  
Product code : 13468368  
Catalog # : 00336ET3ER145TC-W22

Performance : 415 V 50 Hz 2P IE3

Rated current	: 4.13 A	Moment of inertia (J)	: 0.0605 sq.ft.lb
LRC	: 7.1	Duty cycle	: Cont.(S1)
Rated torque	: 5.53 ft.lb	Insulation class	: F
Locked rotor torque	: 320 %	Service factor	: 1.00
Breakdown torque	: 330 %	Temperature rise	: 80 K
Rated speed	: 2850 rpm	Design	: B

Heating constant

Cooling constant

Rev.	Changes Summary	Performed	Checked	Date
Performed by				
Checked by			Page	Revision
Date	13/04/2022		28 / 36	

# THERMAL LIMIT CURVE

Three Phase Induction Motor - Squirrel Cage



Customer : \_\_\_\_\_

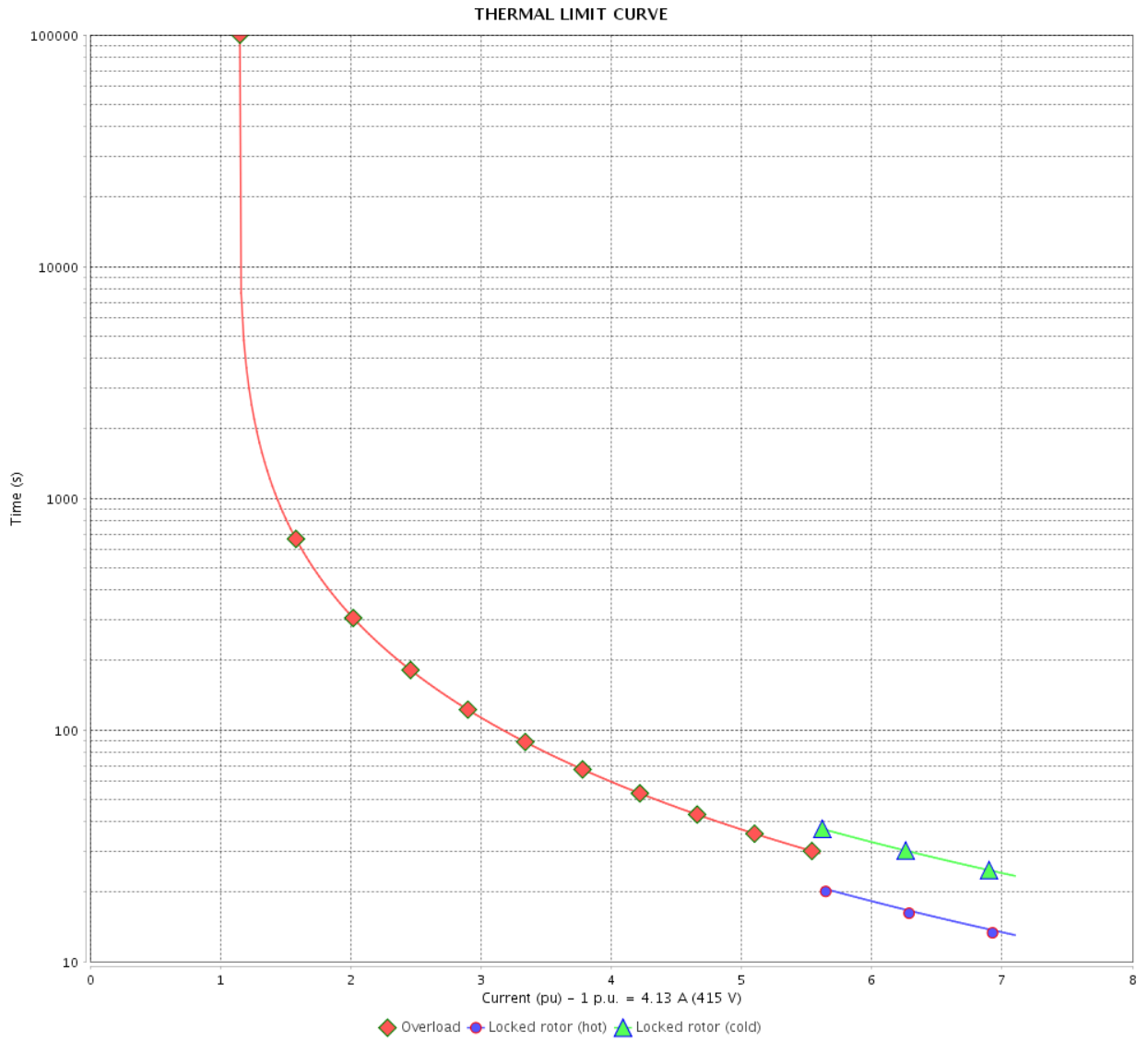

Rev.	Changes Summary	Performed	Checked	Date
Performed by		Page 29 / 36		Revision
Checked by				
Date				

# VFD OPERATION CURVE

Three Phase Induction Motor - Squirrel Cage



Customer :

Product line : NEMA Premium Efficiency Three-Phase

Product code : 13468368

Catalog # : 00336ET3ER145TC-W22

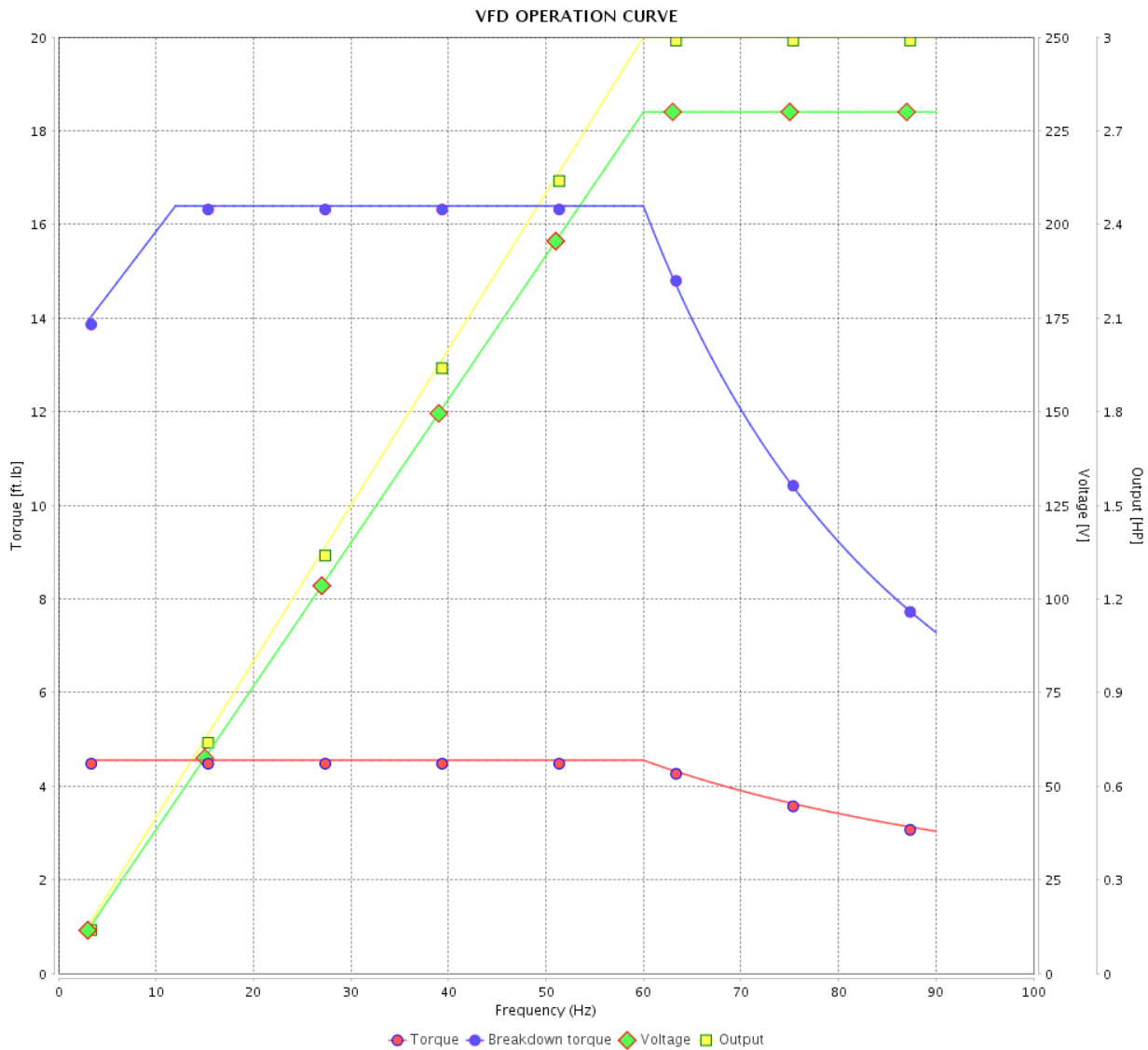

Performance : 230/460 V 60 Hz 2P

Rated current : 7.42/3.71 A  
 LRC : 8.1  
 Rated torque : 4.55 ft.lb  
 Locked rotor torque : 330 %  
 Breakdown torque : 360 %  
 Rated speed : 3460 rpm

Moment of inertia (J) : 0.0605 sq.ft.lb  
 Duty cycle : Cont.(S1)  
 Insulation class : F  
 Service factor : 1.25  
 Temperature rise : 80 K  
 Design : B

Rev.	Changes Summary	Performed	Checked	Date
Performed by			Page	Revision
Checked by				
Date				

# VFD OPERATION CURVE

## Three Phase Induction Motor - Squirrel Cage



Customer :

Product line : NEMA Premium Efficiency Three-Phase  
 Product code : 13468368  
 Catalog # : 00336ET3ER145TC-W22

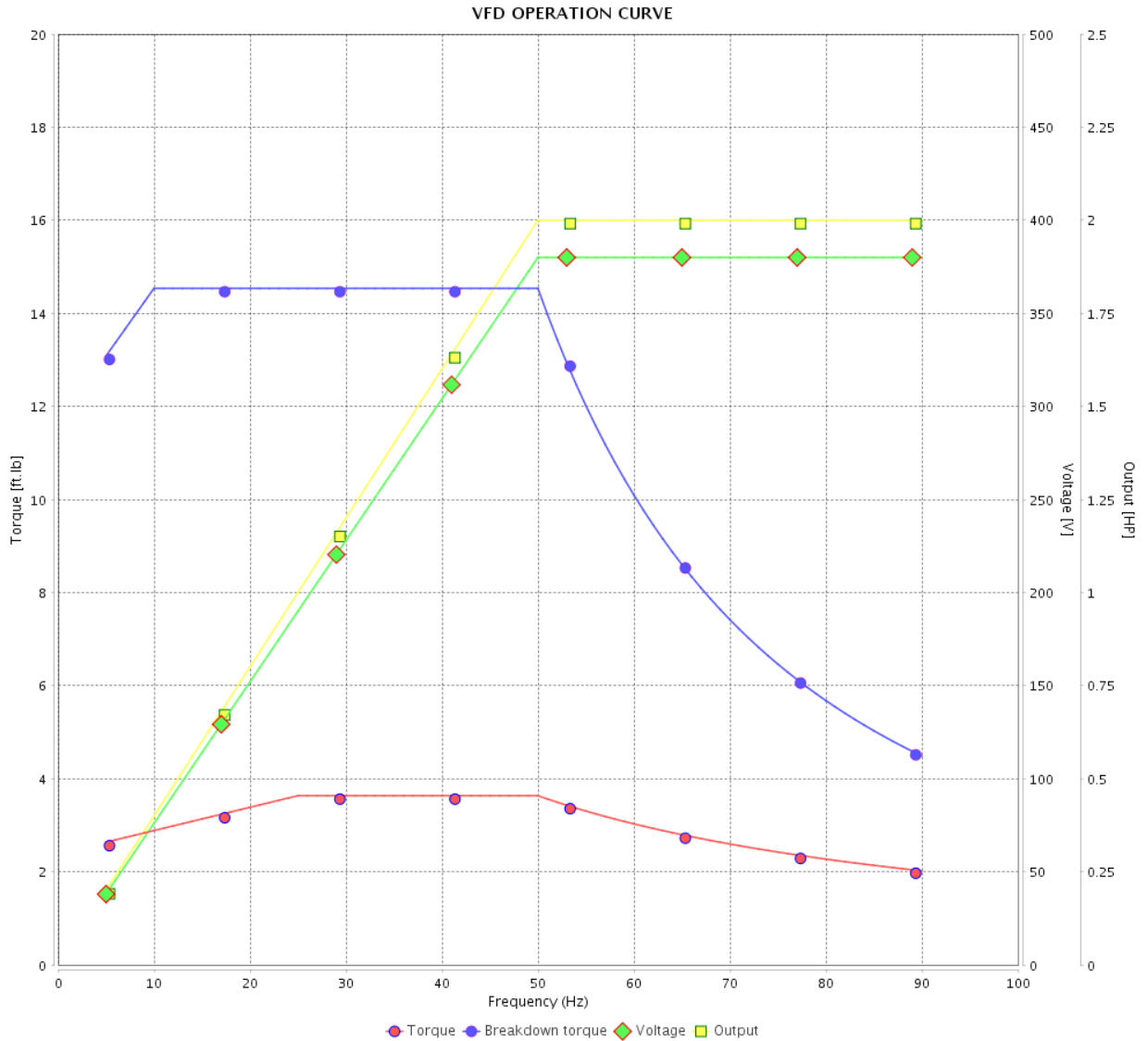

Performance : 380 V 50 Hz 2P IE3

Rated current : 3.24 A	Moment of inertia (J) : 0.0605 sq.ft.lb
LRC : 8.6	Duty cycle : Cont.(S1)
Rated torque : 3.63 ft.lb	Insulation class : F
Locked rotor torque : 400 %	Service factor : 1.25
Breakdown torque : 400 %	Temperature rise : 80 K
Rated speed : 2890 rpm	Design : B

Rev.	Changes Summary	Performed	Checked	Date
Performed by			Page 31 / 36	Revision
Checked by				
Date	13/04/2022			

# VFD OPERATION CURVE

Three Phase Induction Motor - Squirrel Cage



Customer : \_\_\_\_\_

Product line : NEMA Premium Efficiency Three-Phase

Product code : 13468368

Catalog # : 00336ET3ER145TC-W22

VFD OPERATION CURVE

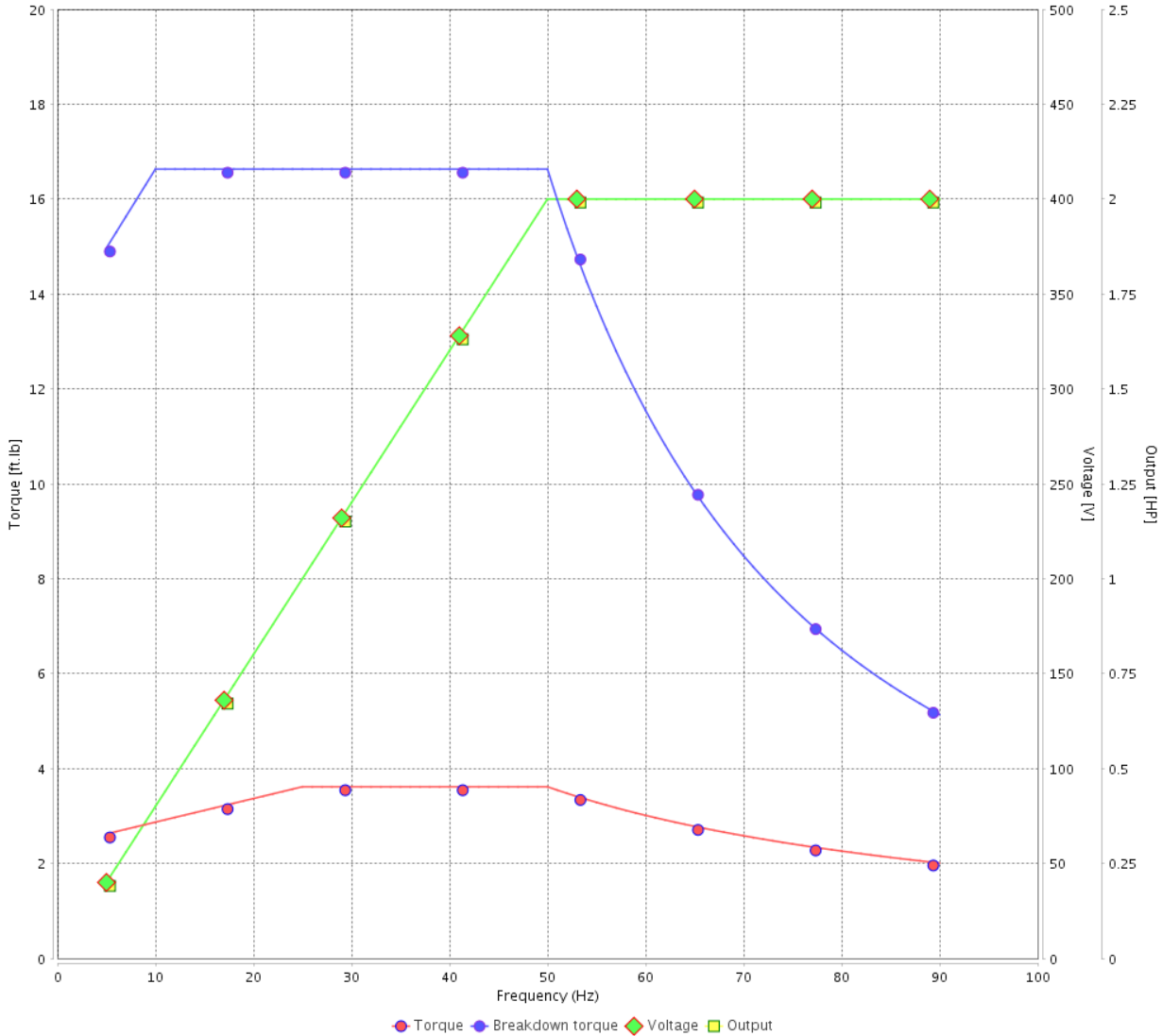

Performance : 400 V 50 Hz 2P IE3

Rated current : 3.17 A  
 LRC : 9.2  
 Rated torque : 3.62 ft.lb  
 Locked rotor torque : 459 %  
 Breakdown torque : 459 %  
 Rated speed : 2905 rpm

Moment of inertia (J) : 0.0605 sq.ft.lb  
 Duty cycle : Cont.(S1)  
 Insulation class : F  
 Service factor : 1.00  
 Temperature rise : 80 K  
 Design : B

Rev.	Changes Summary	Performed	Checked	Date
Performed by			Page	Revision
Checked by				
Date				



# VFD OPERATION CURVE

## Three Phase Induction Motor - Squirrel Cage



Customer : \_\_\_\_\_

Product line : NEMA Premium Efficiency Three-Phase

Product code : 13468368

Catalog # : 00336ET3ER145TC-W22

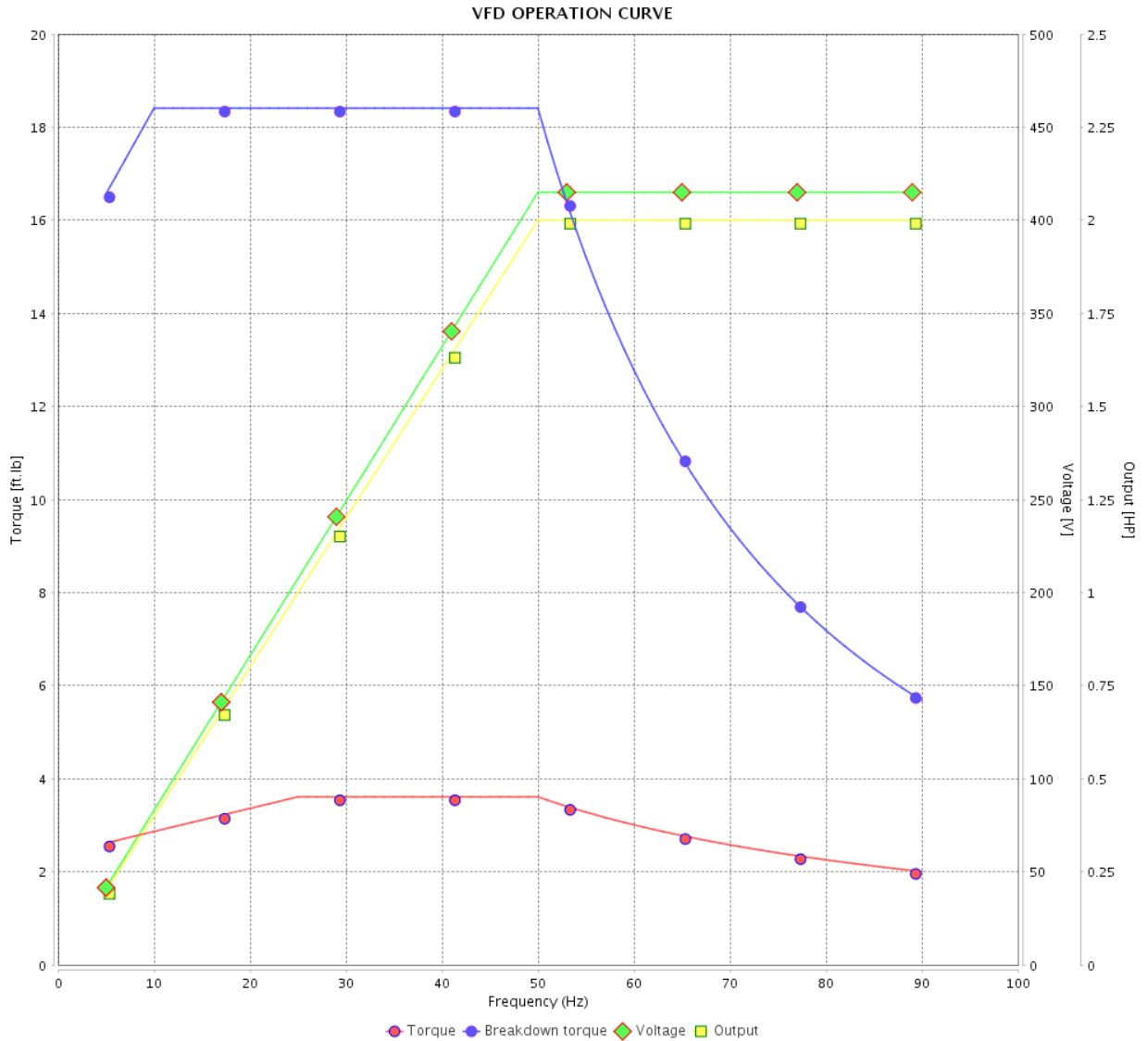

Performance : 415 V 50 Hz 2P IE3

Rated current : 3.15 A  
 LRC : 9.5  
 Rated torque : 3.61 ft.lb  
 Locked rotor torque : 490 %  
 Breakdown torque : 509 %  
 Rated speed : 2910 rpm

Moment of inertia (J) : 0.0605 sq.ft.lb  
 Duty cycle : Cont.(S1)  
 Insulation class : F  
 Service factor : 1.00  
 Temperature rise : 80 K  
 Design : B

Rev.	Changes Summary	Performed	Checked	Date
Performed by		Page		Revision
Checked by		33 / 36		
Date		13/04/2022		

# VFD OPERATION CURVE

Three Phase Induction Motor - Squirrel Cage



Customer : \_\_\_\_\_

Product line : NEMA Premium Efficiency Three-Phase

Product code : 13468368

Catalog # : 00336ET3ER145TC-W22

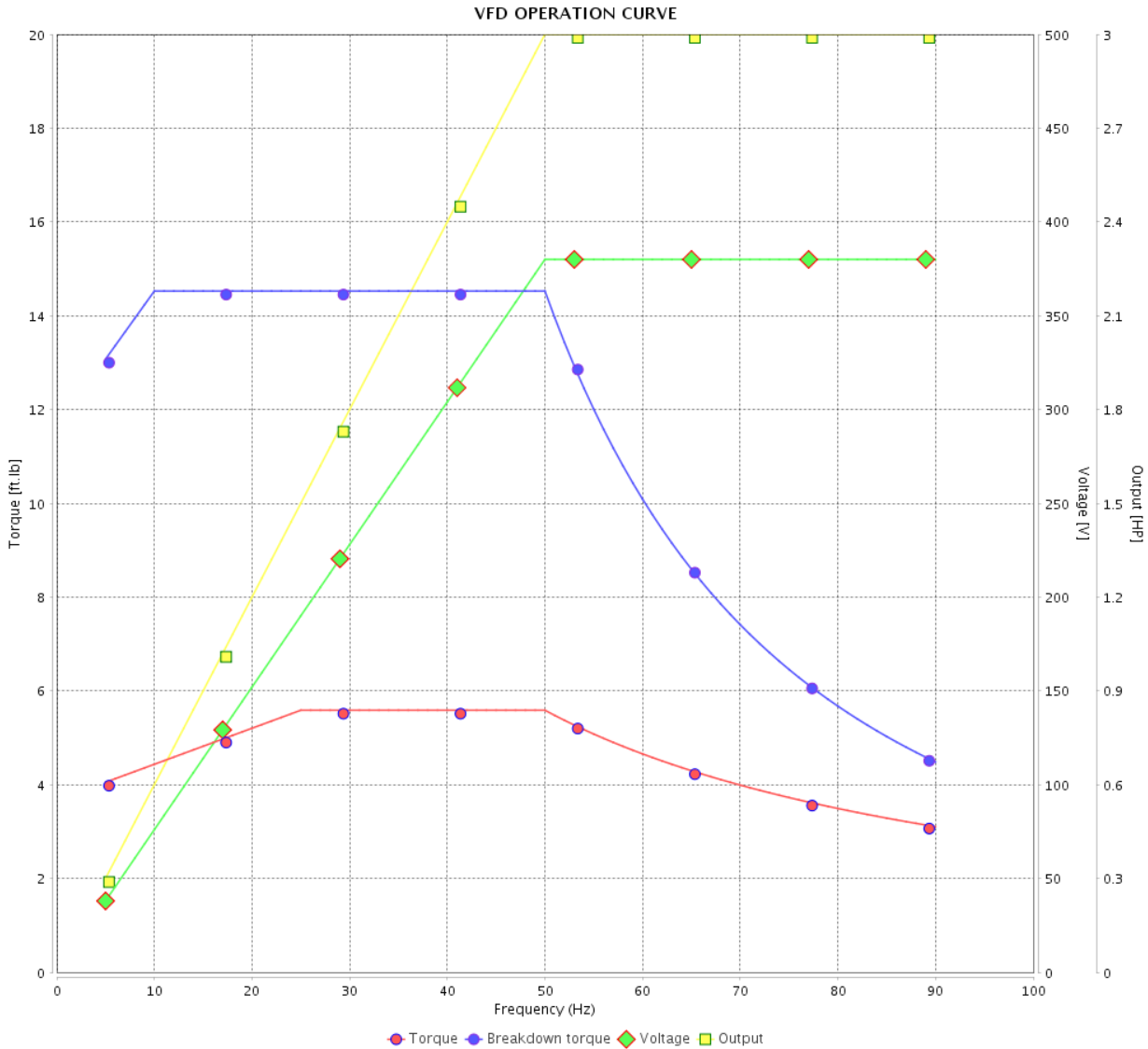

Performance : 380 V 50 Hz 2P IE2

Rated current : 4.44 A  
 LRC : 6.1  
 Rated torque : 5.59 ft.lb  
 Locked rotor torque : 260 %  
 Breakdown torque : 260 %  
 Rated speed : 2820 rpm

Moment of inertia (J) : 0.0605 sq.ft.lb  
 Duty cycle : Cont.(S1)  
 Insulation class : F  
 Service factor : 1.25  
 Temperature rise : 80 K  
 Design : B

Rev.	Changes Summary	Performed	Checked	Date
Performed by			Page 34 / 36	Revision
Checked by				
Date	13/04/2022			

# VFD OPERATION CURVE

## Three Phase Induction Motor - Squirrel Cage



Customer : \_\_\_\_\_

Product line : NEMA Premium Efficiency Three-Phase      Product code : 13468368  
 Catalog # : 00336ET3ER145TC-W22

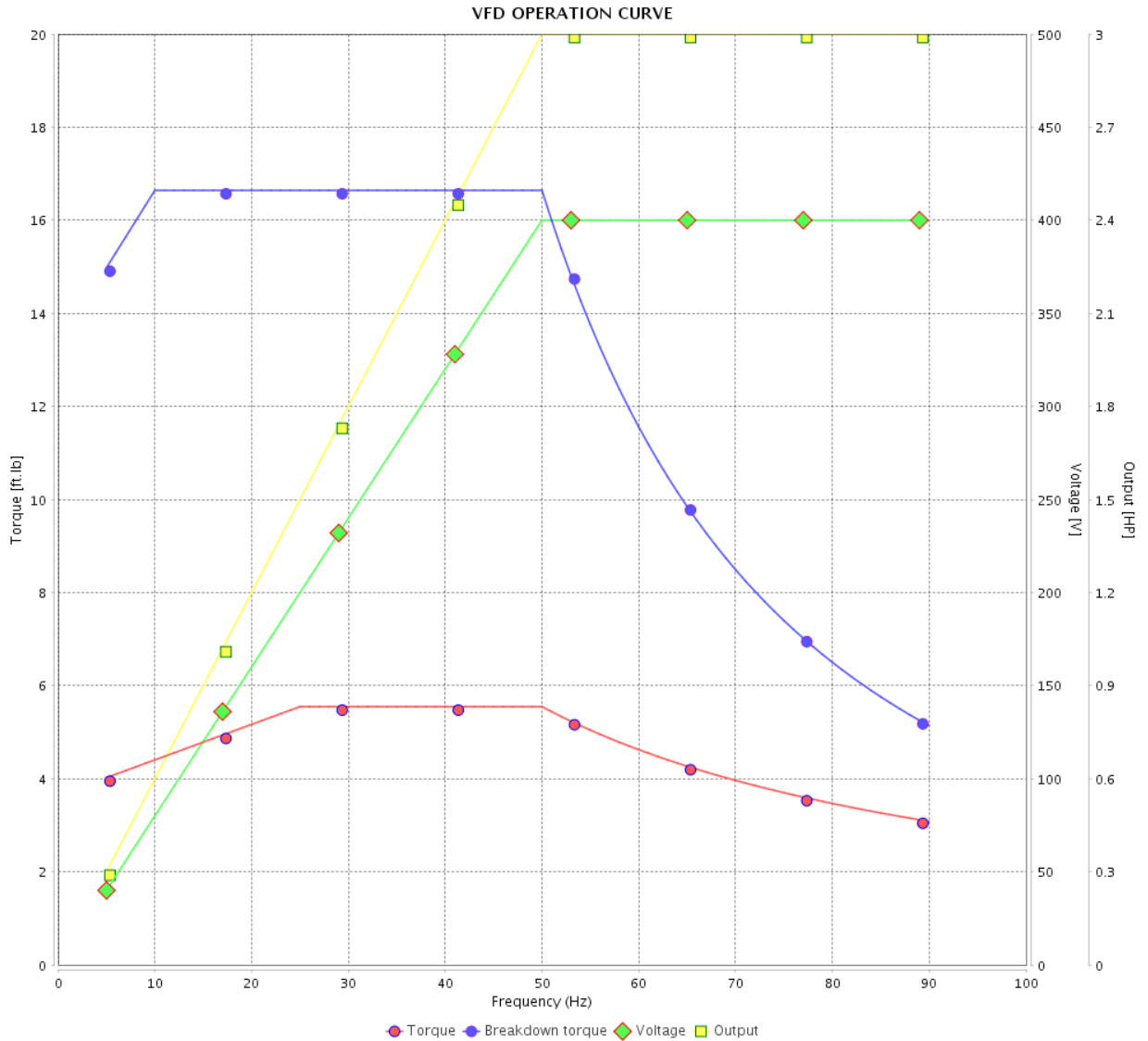

Performance : 400 V 50 Hz 2P IE2

Rated current	: 4.26 A	Moment of inertia (J)	: 0.0605 sq.ft.lb
LRC	: 6.7	Duty cycle	: Cont.(S1)
Rated torque	: 5.55 ft.lb	Insulation class	: F
Locked rotor torque	: 300 %	Service factor	: 1.00
Breakdown torque	: 300 %	Temperature rise	: 80 K
Rated speed	: 2840 rpm	Design	: B

Rev.	Changes Summary	Performed	Checked	Date
Performed by				Page 35 / 36
Checked by				
Date	13/04/2022			

# VFD OPERATION CURVE

Three Phase Induction Motor - Squirrel Cage



Customer :

Product line : NEMA Premium Efficiency Three-Phase

Product code : 13468368

Catalog # : 00336ET3ER145TC-W22

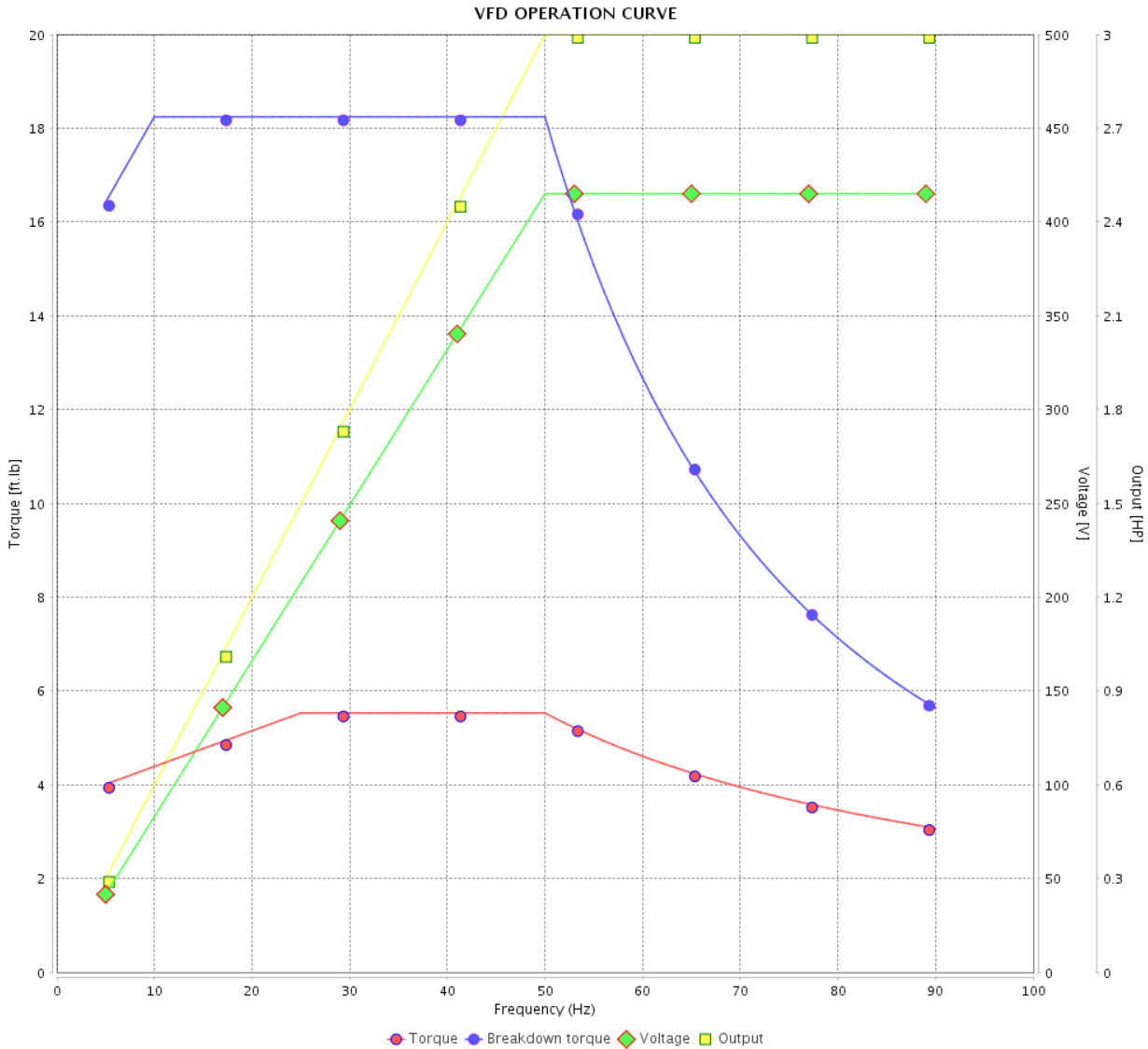

Performance : 415 V 50 Hz 2P IE3

Rated current : 4.13 A  
 LRC : 7.1  
 Rated torque : 5.53 ft.lb  
 Locked rotor torque : 320 %  
 Breakdown torque : 330 %  
 Rated speed : 2850 rpm

Moment of inertia (J) : 0.0605 sq.ft.lb  
 Duty cycle : Cont.(S1)  
 Insulation class : F  
 Service factor : 1.00  
 Temperature rise : 80 K  
 Design : B

Rev.	Changes Summary	Performed	Checked	Date
Performed by			Page 36 / 36	Revision
Checked by				
Date	13/04/2022			

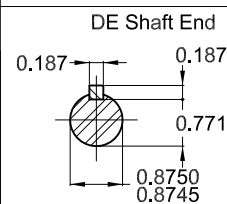
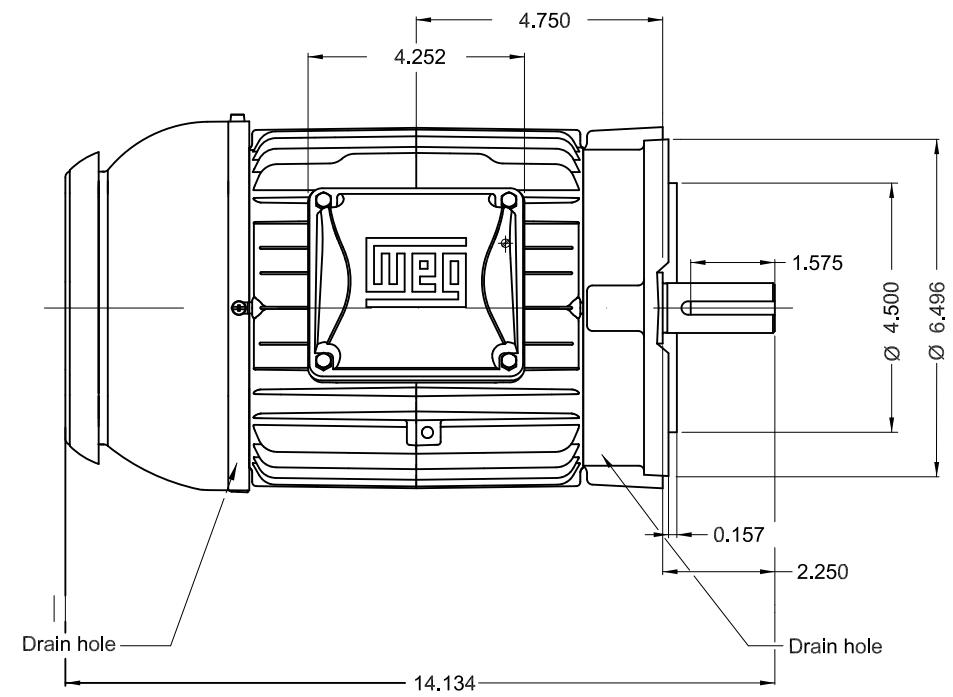
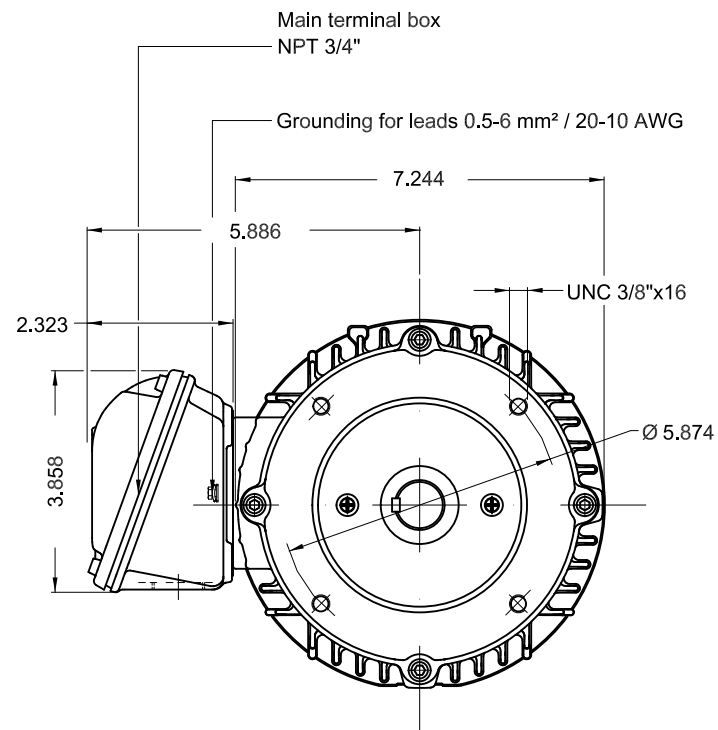

Bearing cap
Color RAL 5009
Painting plan 207A
Mounting NEMA W-6
Mounting V18

3 HP 02 Poles 60 Hz A

ECM	LOC	SUMMARY OF MODIFICATIONS	EXECUTED	CHECKED	RELEASED	DATE	VER
EXECUTED	PIRWBUSER	THREE PH. MOTOR W22 PREM. EFF.					
CHECKED		FRAME 145TC IP55 TEFC					
RELEASED							
REL DT.	WMO	Jaragua do Sul	Product Engineering	SHEET	1 / 1		

**PREVIEW**  
WDD



MADE IN BRAZIL  
13468368



MODEL 00336ET3ER145TC-W22

Inverter Duty Motor  
Severe Duty



For use on 60Hz  
Class I, Div 2, Gr A, B, C and D - T3  
Class I, Zone 2, IIC - T3  
Class II, Div 2, Gr F and G - T5  
For use on PWM: Gr. A, B, C, D, F and G,  
VT 1000:1, CT 20:1, 1.00SF - T4A



FOR SAFE AREA  
Mod. TE1BFOXON  
CC029A

PH3 60Hz Fr. 145TC 1000m.a.s.l. IP55 TEFC 55lb

V 230/460

A 7.42/3.71

HP 3.0

kW 2.2

SF 1.25

SFA 9.28/4.64

RPM 3460

PF 0.86

AMB 40°C

INS cl. F DT80K

NEMA NOM EFF 86.5%

DUTY CONT.

DES B Code J

USABLE @208V 8.20A SF 1.15 SFA 9.43

3.0HP 2.2kW 50Hz 380V 4.44A 2820RPM SF 1.25 SFA 5.55 EFF 84.6% (IE2)

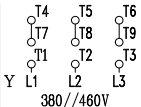
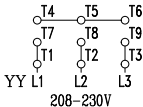

MOBIL POLYREX EM

