

DATA SHEET

Three Phase Induction Motor - Squirrel Cage



Customer :					
Product line	: NEMA Premium Efficiency Three-Phase	Product code :	12132187		
		Catalog # :	00512ET3E215JM-W22		
Frame	: 213/5JM	Cooling method	: IC411 - TEFC		
Insulation class	: F	Mounting	: F-1		
Duty cycle	: Cont.(S1)	Rotation ¹	: Both (CW and CCW)		
Ambient temperature	: -20°C to +40°C	Starting method	: Direct On Line		
Altitude	: 1000 m.a.s.l.	Approx. weight ²	: 178 lb		
Protection degree	: IP55	Moment of inertia (J)	: 1.47 sq.ft.lb		
Design	: B				
Output [HP]	5	5	5	5	
Poles	6	6	6	6	
Frequency [Hz]	60	50	50	50	
Rated voltage [V]	230/460	380	400	415	
Rated current [A]	13.7/6.83	8.10	7.82	7.55	
L. R. Amperes [A]	92.9/46.4	44.5	47.7	49.1	
LRC [A]	6.8x(Code J)	5.5x(Code G)	6.1x(Code H)	6.5x(Code H)	
No load current [A]	6.90/3.45	3.41	3.68	3.90	
Rated speed [RPM]	1170	960	965	970	
Slip [%]	2.50	4.00	3.50	3.00	
Rated torque [ft.lb]	22.4	27.4	27.2	27.1	
Locked rotor torque [%]	170	140	160	190	
Breakdown torque [%]	260	200	229	250	
Service factor	1.25	1.00	1.00	1.00	
Temperature rise	80 K	80 K	80 K	80 K	
Locked rotor time	102s (cold) 57s (hot)	54s (cold) 30s (hot)	54s (cold) 30s (hot)	54s (cold) 30s (hot)	
Noise level ²	55.0 dB(A)	53.0 dB(A)	53.0 dB(A)	53.0 dB(A)	
Efficiency (%)	25%	88.2	89.8	89.1	87.2
	50%	88.5	88.5	88.5	87.5
	75%	89.5	88.5	88.5	88.5
	100%	89.5	86.8	87.5	88.5
Power Factor	25%	0.34	0.40	0.37	0.34
	50%	0.58	0.65	0.61	0.58
	75%	0.70	0.76	0.73	0.71
	100%	0.76	0.80	0.78	0.77
Bearing type	: Drive end : 6309 Z C3 Non drive end : 6207 ZZ	Foundation loads			
Sealing	: V'Ring V'Ring	Max. traction	: 292 lb		
Lubrication interval	: 20000 h 40000 h	Max. compression	: 471 lb		
Lubricant amount	: 13 g 0 g				
Lubricant type	: Mobil Polyrex EM				
Notes USABLE @208V 15.1A SF 1.15 SFA 17.4A					
This revision replaces and cancel the previous one, which must be eliminated. (1) Looking the motor from the shaft end. (2) Measured at 1m and with tolerance of +3dB(A). (3) Approximate weight subject to changes after manufacturing process. (4) At 100% of full load.			These are average values based on tests with sinusoidal power supply, subject to the tolerances stipulated in NEMA MG-1.		
Rev.	Changes Summary		Performed	Checked	Date
Performed by					
Checked by				Page	Revision
Date	12/04/2022			1 / 21	

TORQUE AND CURRENT VS SPEED CURVE

Three Phase Induction Motor - Squirrel Cage



Customer :

Product line : NEMA Premium Efficiency Three-Phase

Product code : 12132187

Catalog # : 00512ET3E215JM-W22

TORQUE AND CURRENT VS SPEED CURVE

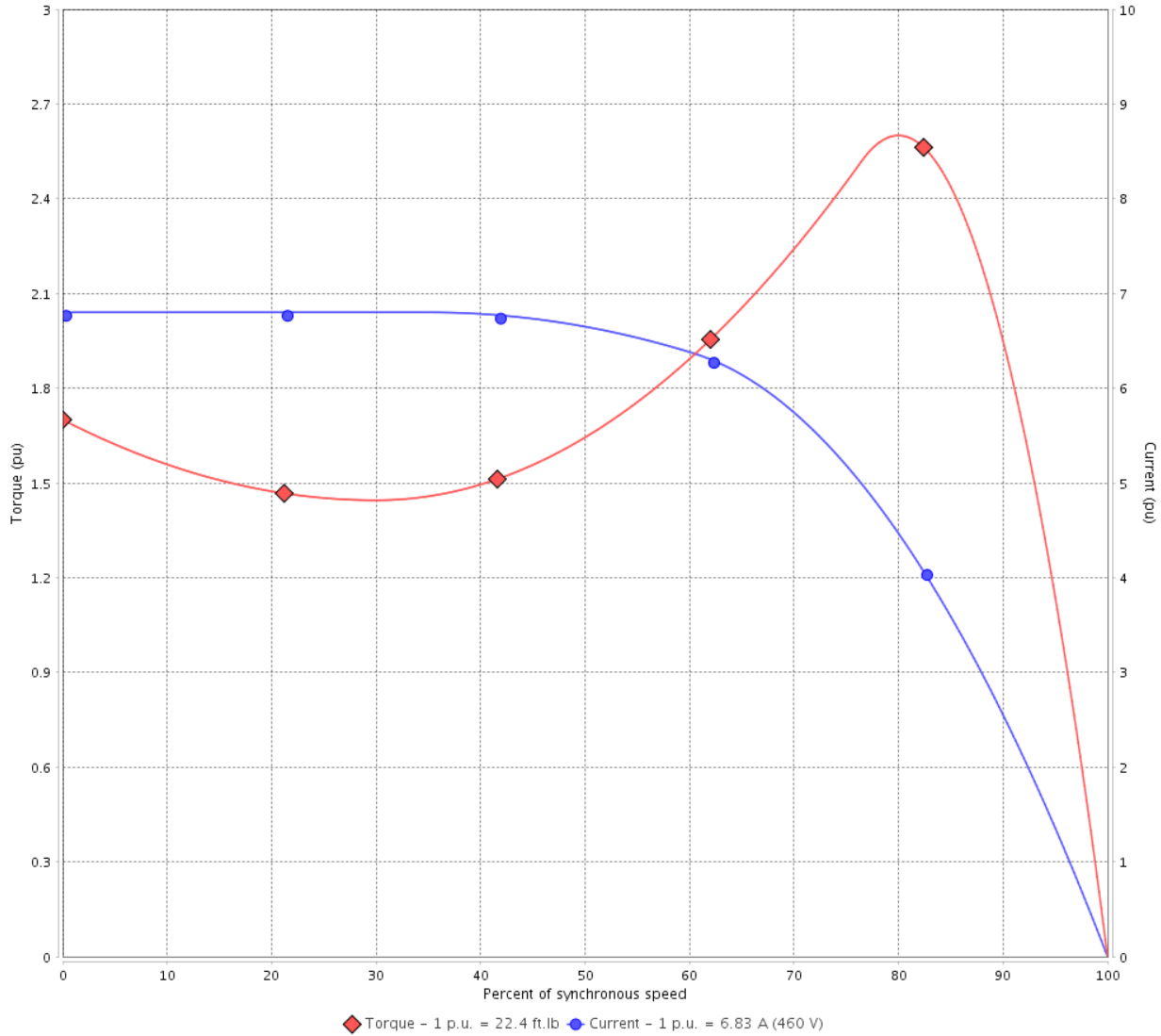

Performance : 230/460 V 60 Hz 6P

Rated current	: 13.7/6.83 A	Moment of inertia (J)	: 1.47 sq.ft.lb
LRC	: 6.8	Duty cycle	: Cont.(S1)
Rated torque	: 22.4 ft.lb	Insulation class	: F
Locked rotor torque	: 170 %	Service factor	: 1.25
Breakdown torque	: 260 %	Temperature rise	: 80 K
Rated speed	: 1170 rpm	Design	: B

Locked rotor time : 102s (cold) 57s (hot)

Rev.	Changes Summary	Performed	Checked	Date
Performed by			Page 2 / 21	Revision
Checked by				
Date	12/04/2022			

TORQUE AND CURRENT VS SPEED CURVE



Three Phase Induction Motor - Squirrel Cage

Customer :
 Product line : NEMA Premium Efficiency Three-Phase Product code : 12132187
 Catalog # : 00512ET3E215JM-W22

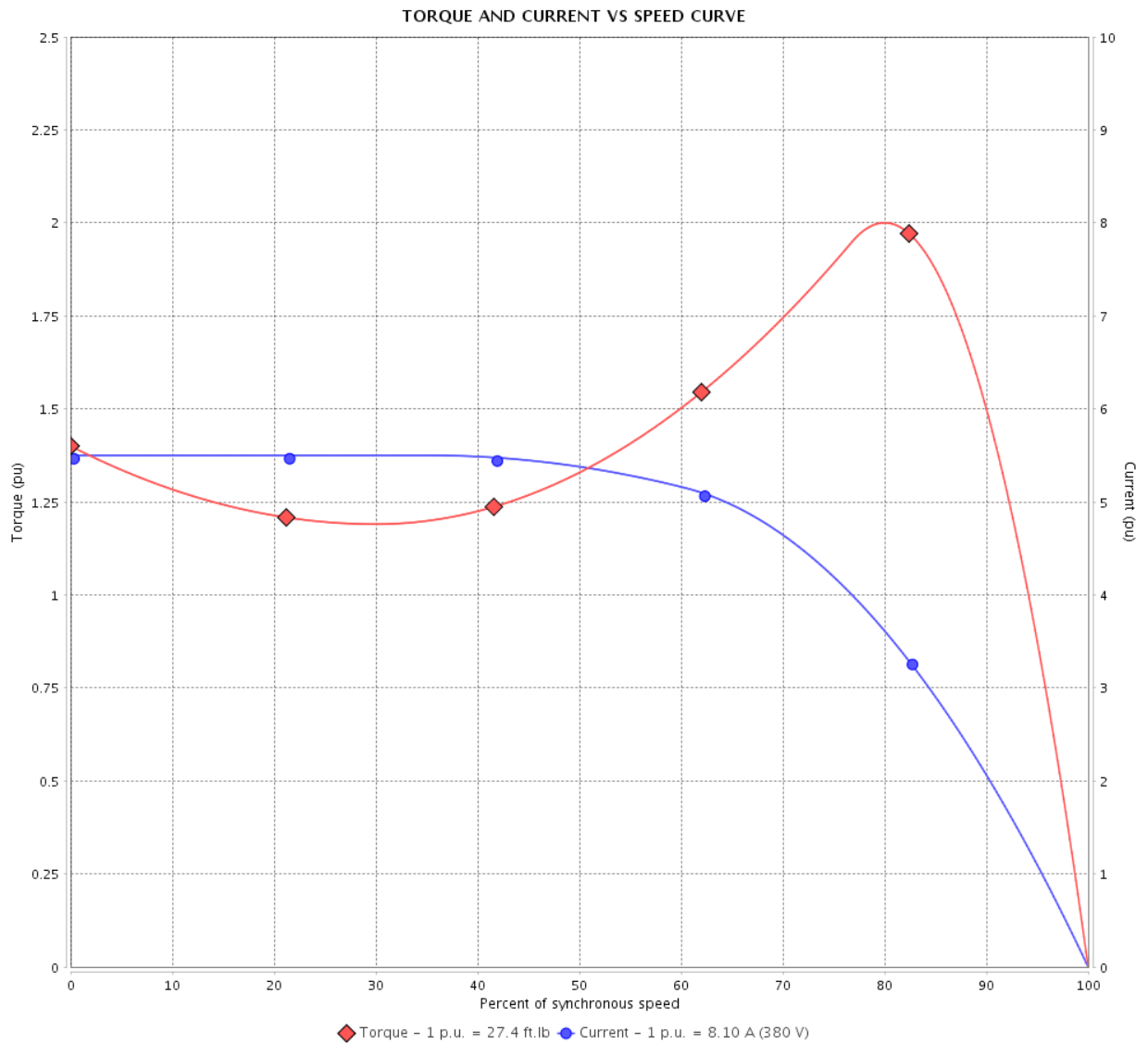

Performance	: 380 V 50 Hz 6P IE3		
Rated current	: 8.10 A	Moment of inertia (J)	: 1.47 sq.ft.lb
LRC	: 5.5	Duty cycle	: Cont.(S1)
Rated torque	: 27.4 ft.lb	Insulation class	: F
Locked rotor torque	: 140 %	Service factor	: 1.00
Breakdown torque	: 200 %	Temperature rise	: 80 K
Rated speed	: 960 rpm	Design	: B

Locked rotor time : 54s (cold) 30s (hot)

Rev.	Changes Summary	Performed	Checked	Date
Performed by			Page	Revision
Checked by				
Date	12/04/2022			

TORQUE AND CURRENT VS SPEED CURVE

Three Phase Induction Motor - Squirrel Cage



Customer :

Product line : NEMA Premium Efficiency Three-Phase

Product code : 12132187

Catalog # : 00512ET3E215JM-W22

TORQUE AND CURRENT VS SPEED CURVE

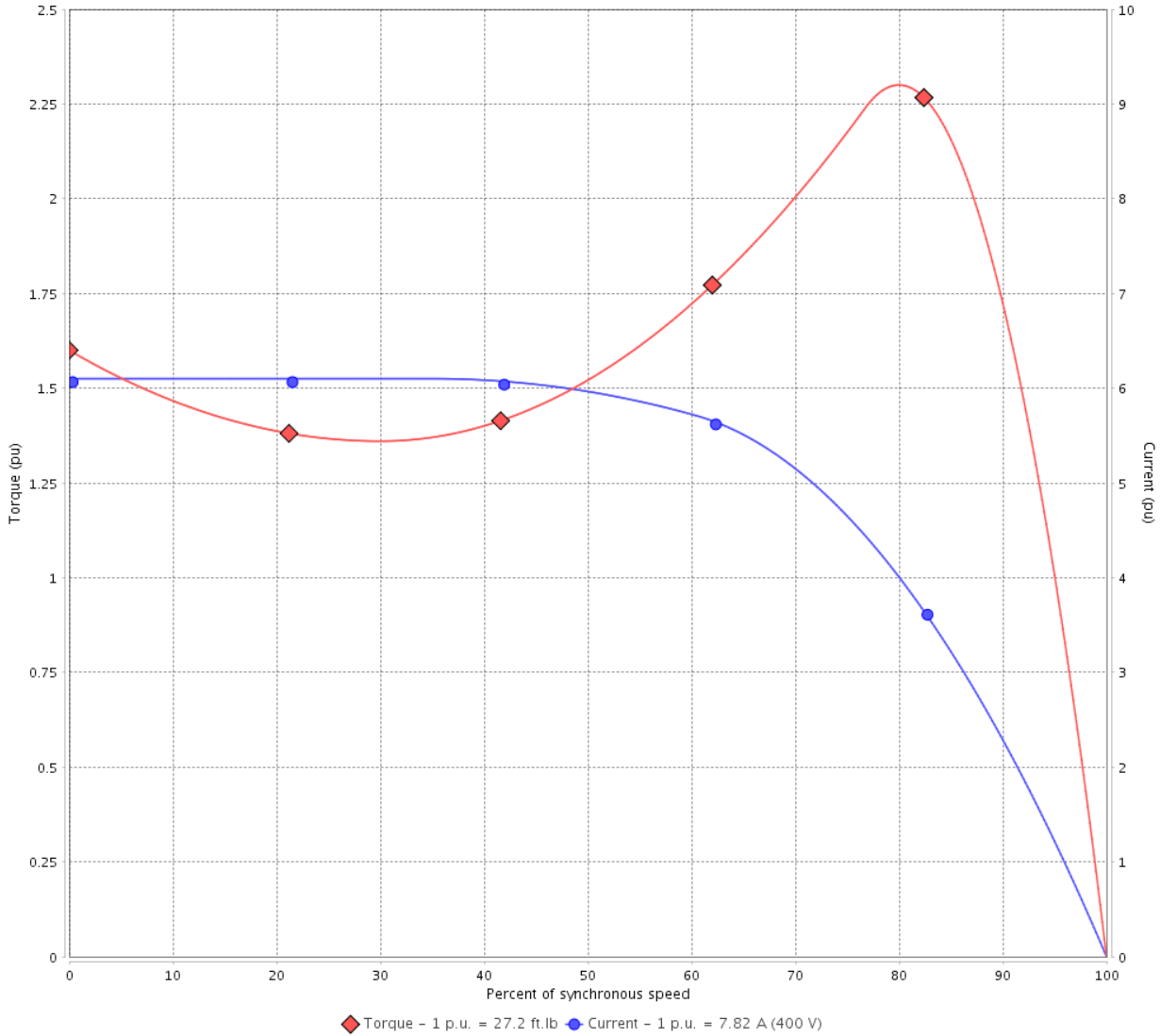

Performance : 400 V 50 Hz 6P IE3

Rated current	: 7.82 A	Moment of inertia (J)	: 1.47 sq.ft.lb
LRC	: 6.1	Duty cycle	: Cont.(S1)
Rated torque	: 27.2 ft.lb	Insulation class	: F
Locked rotor torque	: 160 %	Service factor	: 1.00
Breakdown torque	: 229 %	Temperature rise	: 80 K
Rated speed	: 965 rpm	Design	: B

Locked rotor time : 54s (cold) 30s (hot)

Rev.	Changes Summary	Performed	Checked	Date
Performed by			Page 4 / 21	Revision
Checked by				
Date	12/04/2022			

TORQUE AND CURRENT VS SPEED CURVE



Three Phase Induction Motor - Squirrel Cage

Customer :

Product line : NEMA Premium Efficiency Three-Phase

Product code : 12132187

Catalog # : 00512ET3E215JM-W22

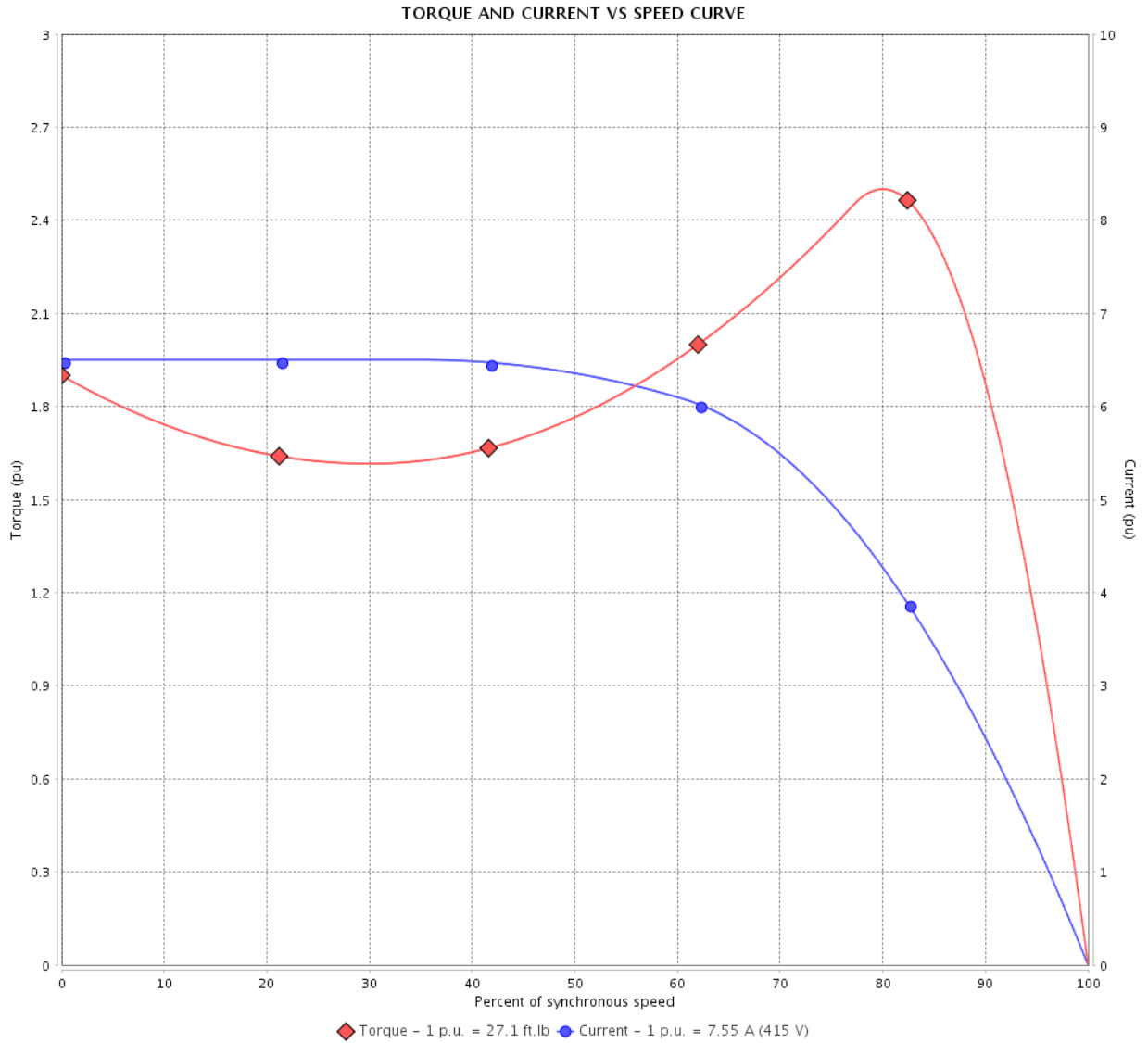

Performance : 415 V 50 Hz 6P IE3

Rated current	: 7.55 A	Moment of inertia (J)	: 1.47 sq.ft.lb
LRC	: 6.5	Duty cycle	: Cont.(S1)
Rated torque	: 27.1 ft.lb	Insulation class	: F
Locked rotor torque	: 190 %	Service factor	: 1.00
Breakdown torque	: 250 %	Temperature rise	: 80 K
Rated speed	: 970 rpm	Design	: B

Locked rotor time : 54s (cold) 30s (hot)

Rev.	Changes Summary	Performed	Checked	Date
Performed by			Page 5 / 21	Revision
Checked by				
Date	12/04/2022			

LOAD PERFORMANCE CURVE

Three Phase Induction Motor - Squirrel Cage



Customer :

Product line : NEMA Premium Efficiency Three-Phase

Product code : 12132187

Catalog # : 00512ET3E215JM-W22

LOAD PERFORMANCE CURVE

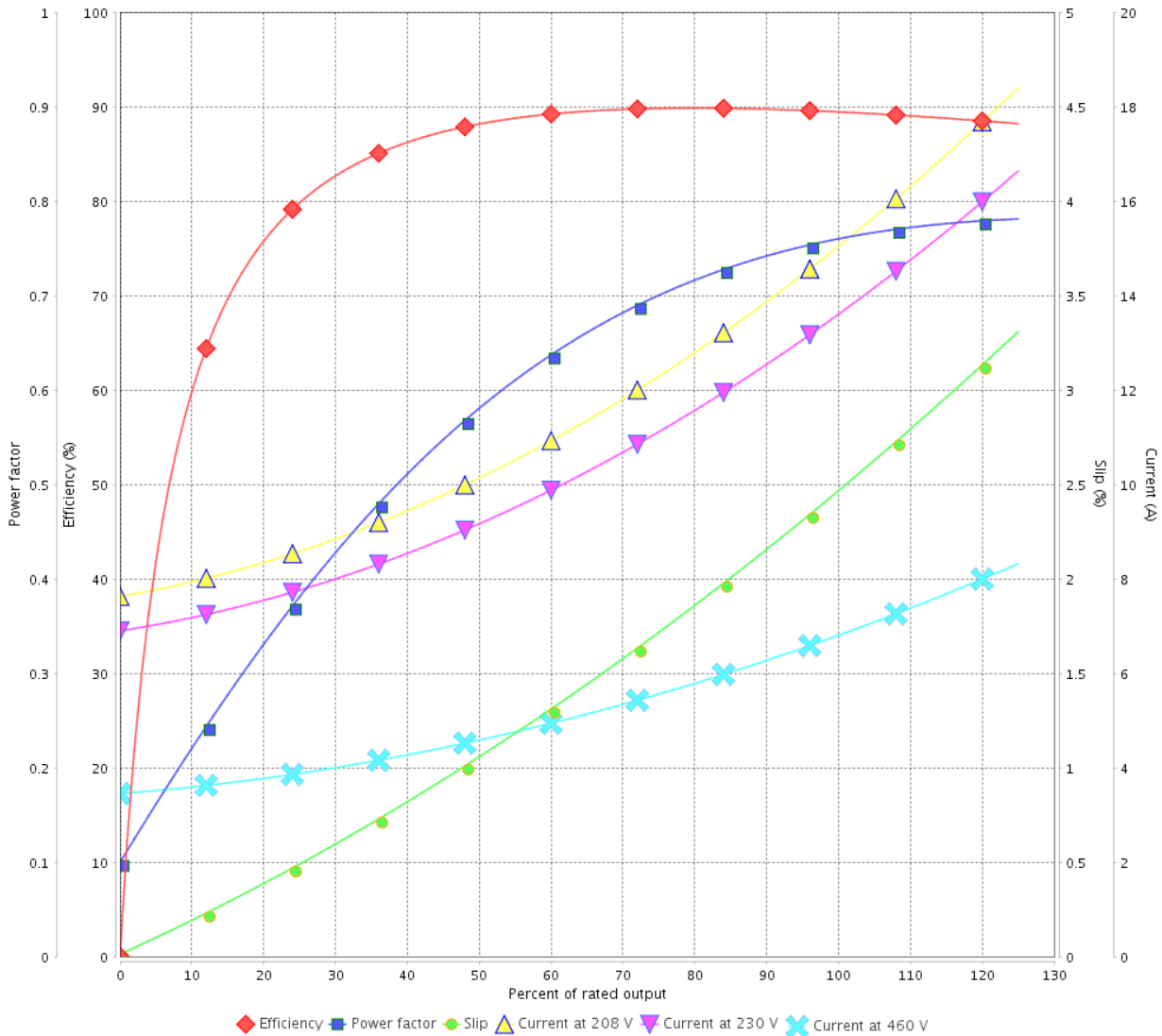

Performance : 230/460 V 60 Hz 6P

Rated current : 13.7/6.83 A
 LRC : 6.8
 Rated torque : 22.4 ft.lb
 Locked rotor torque : 170 %
 Breakdown torque : 260 %
 Rated speed : 1170 rpm

Moment of inertia (J) : 1.47 sq.ft.lb
 Duty cycle : Cont.(S1)
 Insulation class : F
 Service factor : 1.25
 Temperature rise : 80 K
 Design : B

Rev.	Changes Summary	Performed	Checked	Date
Performed by		Page		Revision
Checked by		6 / 21		
Date		12/04/2022		

LOAD PERFORMANCE CURVE

Three Phase Induction Motor - Squirrel Cage



Customer :

Product line : NEMA Premium Efficiency Three-Phase

Product code : 12132187

Catalog # : 00512ET3E215JM-W22

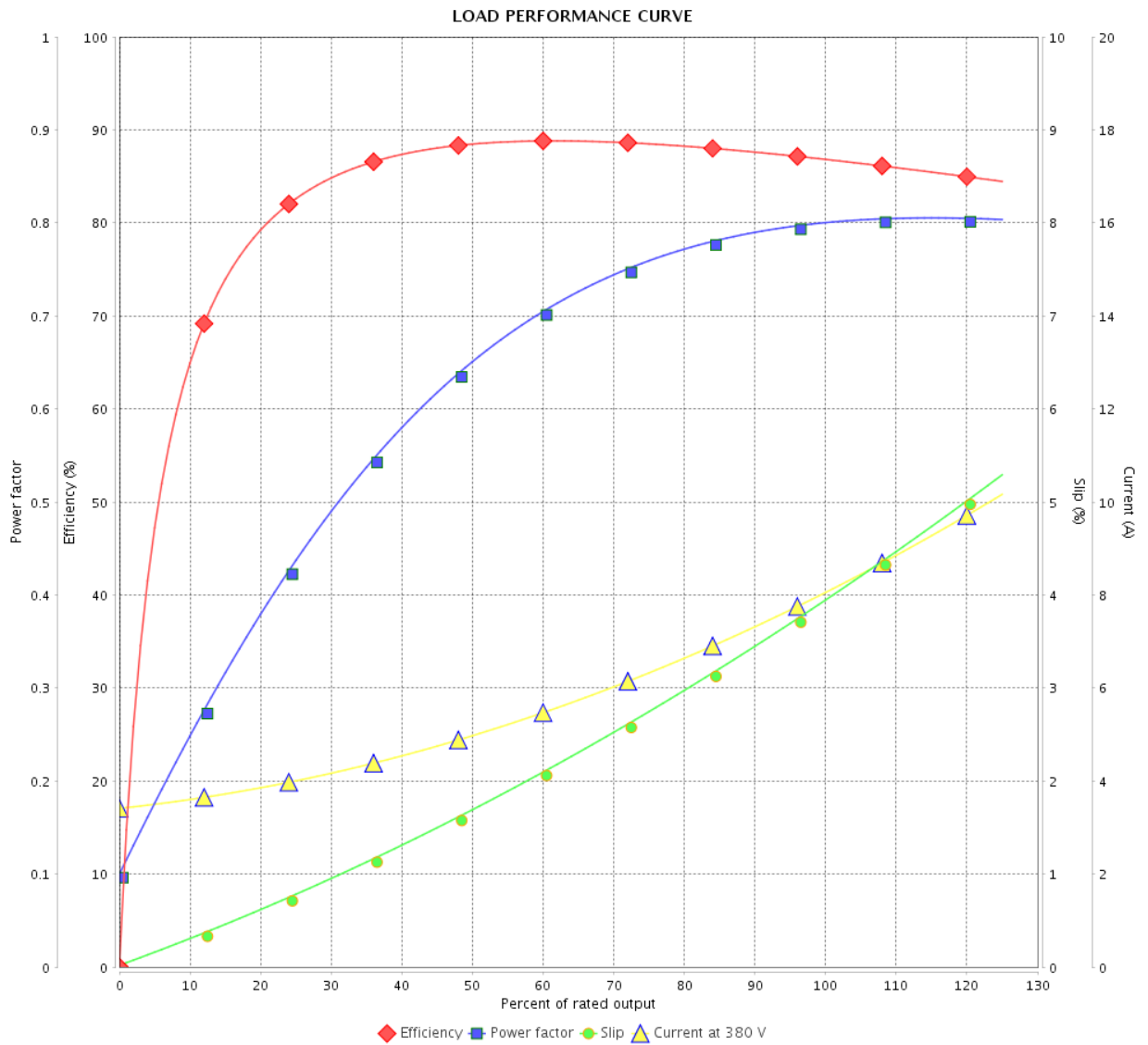

Performance : 380 V 50 Hz 6P IE3

Rated current : 8.10 A
 LRC : 5.5
 Rated torque : 27.4 ft.lb
 Locked rotor torque : 140 %
 Breakdown torque : 200 %
 Rated speed : 960 rpm

Moment of inertia (J) : 1.47 sq.ft.lb
 Duty cycle : Cont.(S1)
 Insulation class : F
 Service factor : 1.00
 Temperature rise : 80 K
 Design : B

Rev.	Changes Summary	Performed	Checked	Date
Performed by			Page	Revision
Checked by			7 / 21	
Date	12/04/2022			

LOAD PERFORMANCE CURVE

Three Phase Induction Motor - Squirrel Cage



Customer :

Product line : NEMA Premium Efficiency Three-Phase

Product code : 12132187

Catalog # : 00512ET3E215JM-W22

LOAD PERFORMANCE CURVE

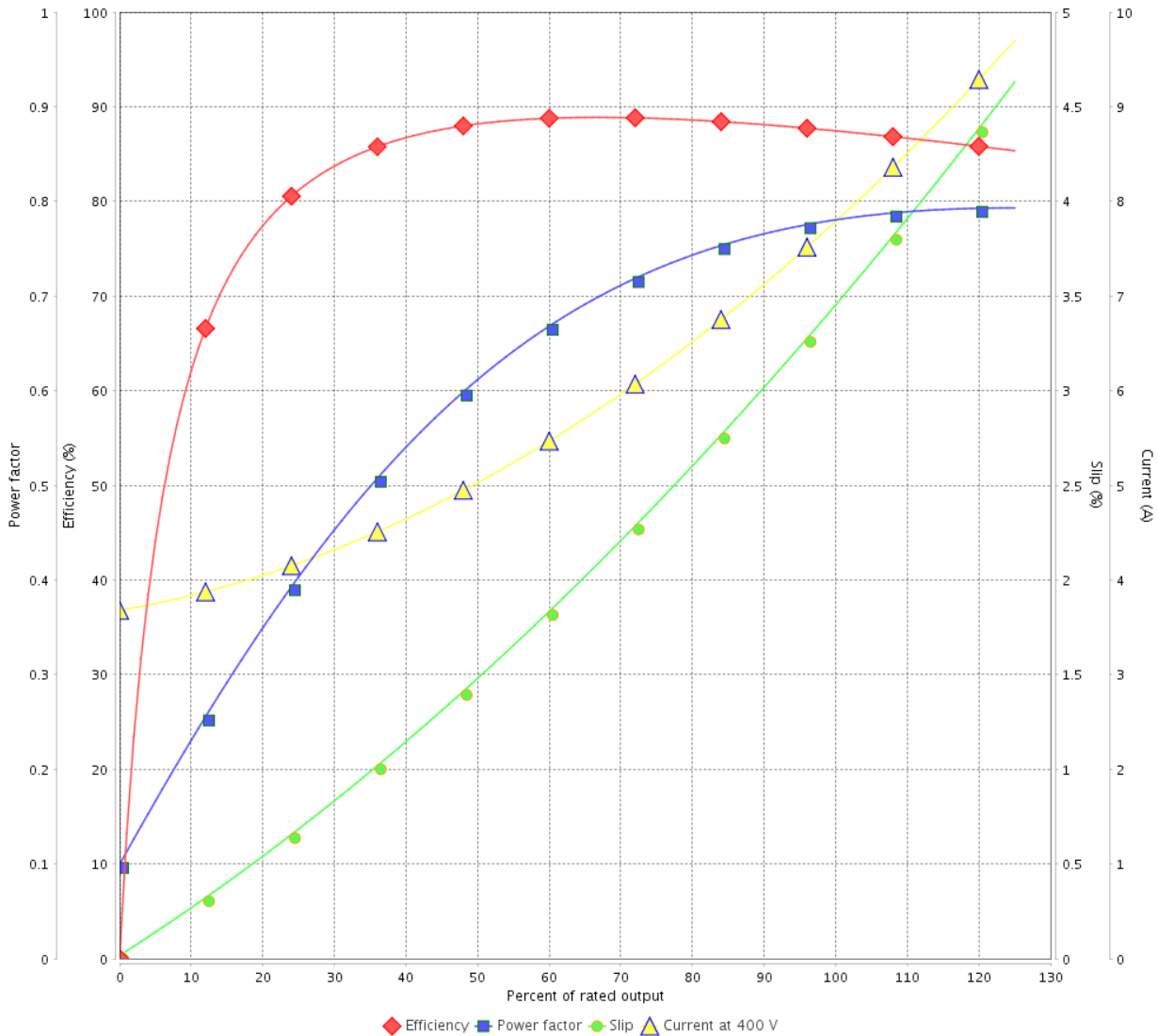

Performance : 400 V 50 Hz 6P IE3

Rated current : 7.82 A
 LRC : 6.1
 Rated torque : 27.2 ft.lb
 Locked rotor torque : 160 %
 Breakdown torque : 229 %
 Rated speed : 965 rpm

Moment of inertia (J) : 1.47 sq.ft.lb
 Duty cycle : Cont.(S1)
 Insulation class : F
 Service factor : 1.00
 Temperature rise : 80 K
 Design : B

Rev.	Changes Summary	Performed	Checked	Date
Performed by			Page 8 / 21	Revision
Checked by				
Date	12/04/2022			

LOAD PERFORMANCE CURVE

Three Phase Induction Motor - Squirrel Cage



Customer :

Product line : NEMA Premium Efficiency Three-Phase

Product code : 12132187

Catalog # : 00512ET3E215JM-W22

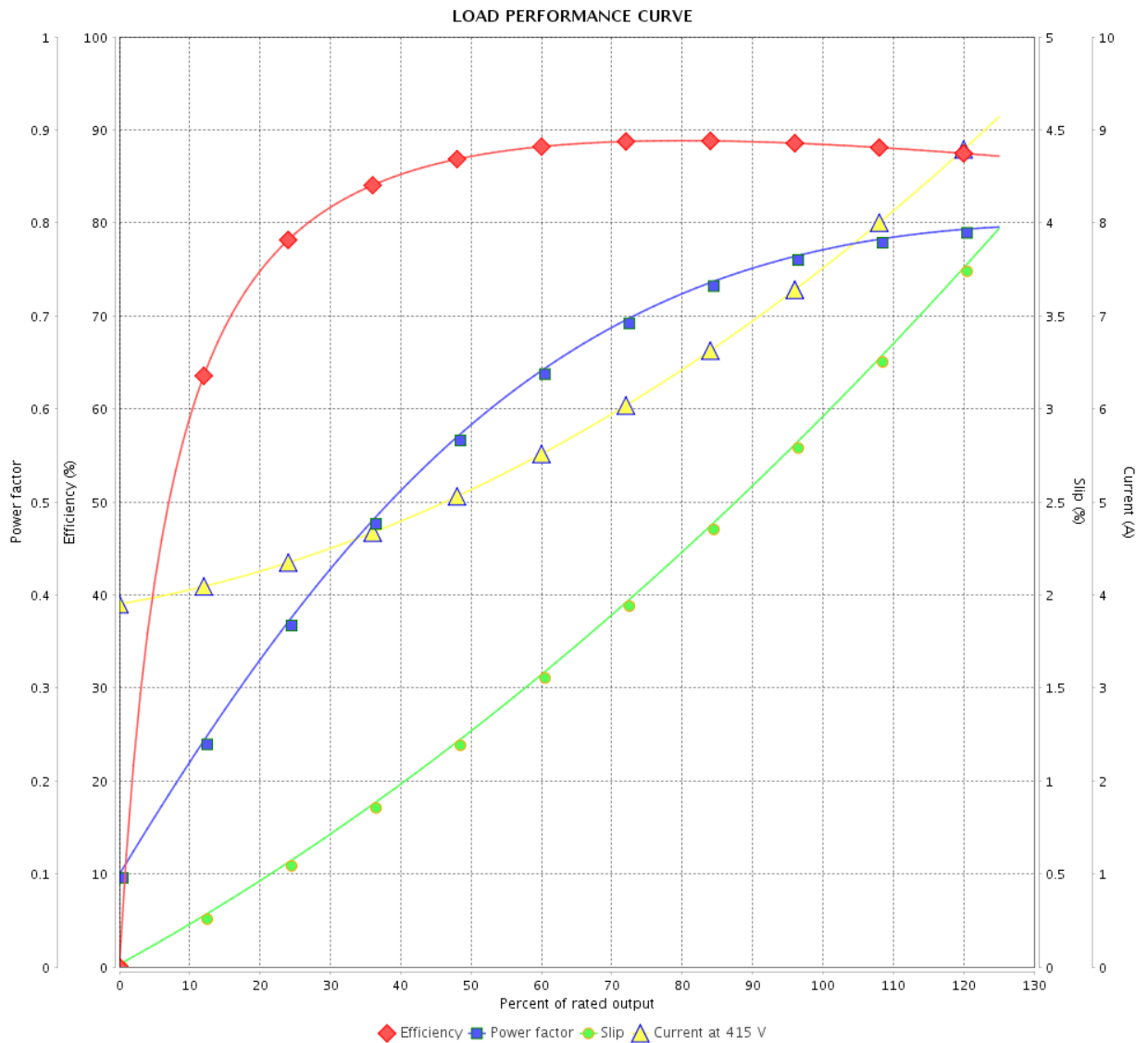

Performance : 415 V 50 Hz 6P IE3

Rated current : 7.55 A
 LRC : 6.5
 Rated torque : 27.1 ft.lb
 Locked rotor torque : 190 %
 Breakdown torque : 250 %
 Rated speed : 970 rpm

Moment of inertia (J) : 1.47 sq.ft.lb
 Duty cycle : Cont.(S1)
 Insulation class : F
 Service factor : 1.00
 Temperature rise : 80 K
 Design : B

Rev.	Changes Summary	Performed	Checked	Date
Performed by		Page		Revision
Checked by		9 / 21		
Date		12/04/2022		

THERMAL LIMIT CURVE



Three Phase Induction Motor - Squirrel Cage

Customer :

Product line : NEMA Premium Efficiency Three-Phase
 Product code : 12132187
 Catalog # : 00512ET3E215JM-W22

Performance : 230/460 V 60 Hz 6P

Rated current : 13.7/6.83 A	Moment of inertia (J) : 1.47 sq.ft.lb
LRC : 6.8	Duty cycle : Cont.(S1)
Rated torque : 22.4 ft.lb	Insulation class : F
Locked rotor torque : 170 %	Service factor : 1.25
Breakdown torque : 260 %	Temperature rise : 80 K
Rated speed : 1170 rpm	Design : B

Heating constant

Cooling constant

Rev.	Changes Summary	Performed	Checked	Date
Performed by			Page 10 / 21	Revision
Checked by				
Date	12/04/2022			

THERMAL LIMIT CURVE

Three Phase Induction Motor - Squirrel Cage



Customer : _____

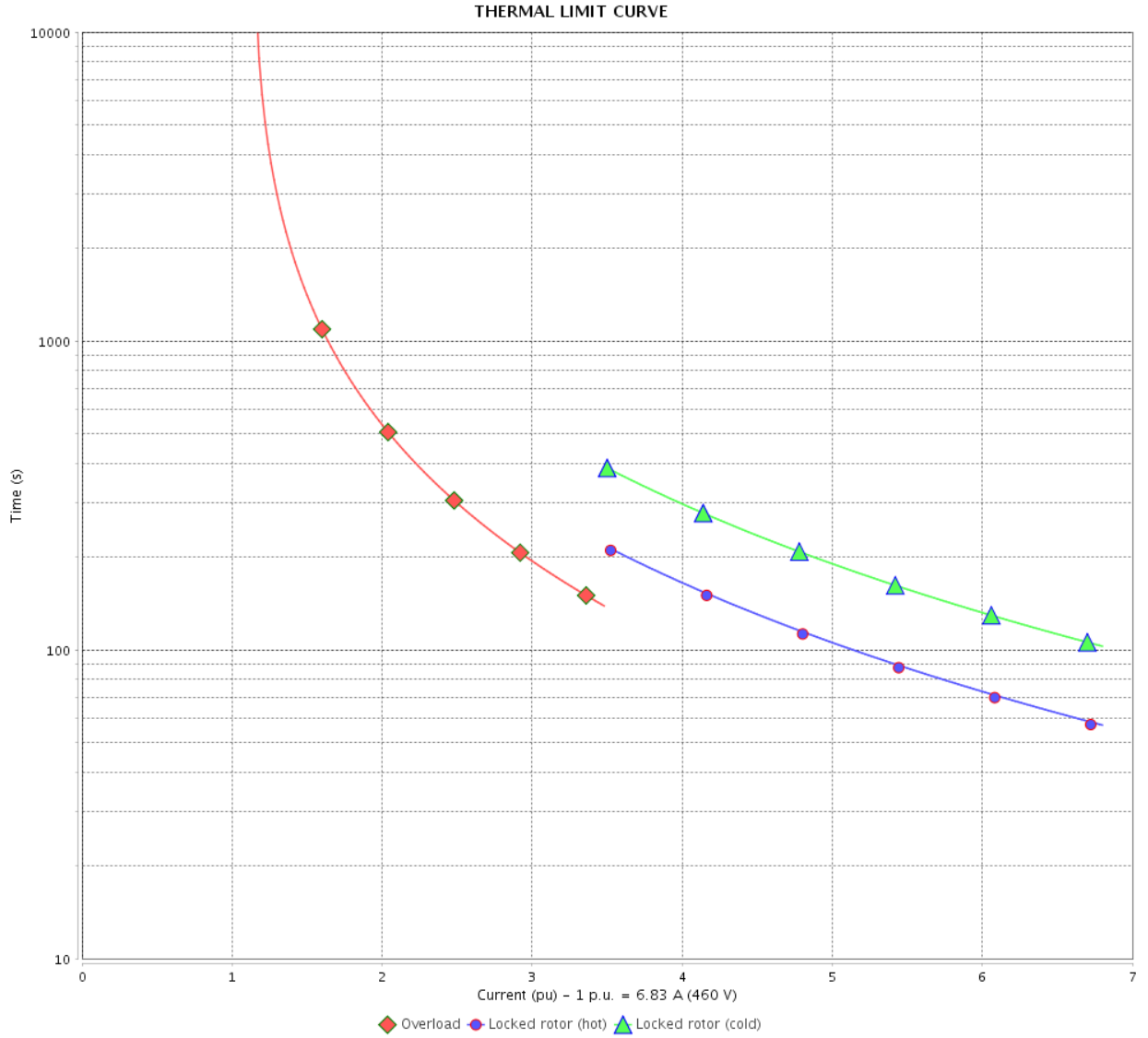

Rev.	Changes Summary	Performed	Checked	Date
Performed by		Page		Revision
Checked by		11 / 21		
Date		12/04/2022		

THERMAL LIMIT CURVE



Three Phase Induction Motor - Squirrel Cage

Customer :

Product line : NEMA Premium Efficiency Three-Phase
Product code : 12132187
Catalog # : 00512ET3E215JM-W22

Performance : 380 V 50 Hz 6P IE3

Rated current	: 8.10 A	Moment of inertia (J)	: 1.47 sq.ft.lb
LRC	: 5.5	Duty cycle	: Cont.(S1)
Rated torque	: 27.4 ft.lb	Insulation class	: F
Locked rotor torque	: 140 %	Service factor	: 1.00
Breakdown torque	: 200 %	Temperature rise	: 80 K
Rated speed	: 960 rpm	Design	: B

Heating constant

Cooling constant

Rev.	Changes Summary	Performed	Checked	Date
Performed by				
Checked by			Page	Revision
Date	12/04/2022		12 / 21	

THERMAL LIMIT CURVE

Three Phase Induction Motor - Squirrel Cage



Customer : _____

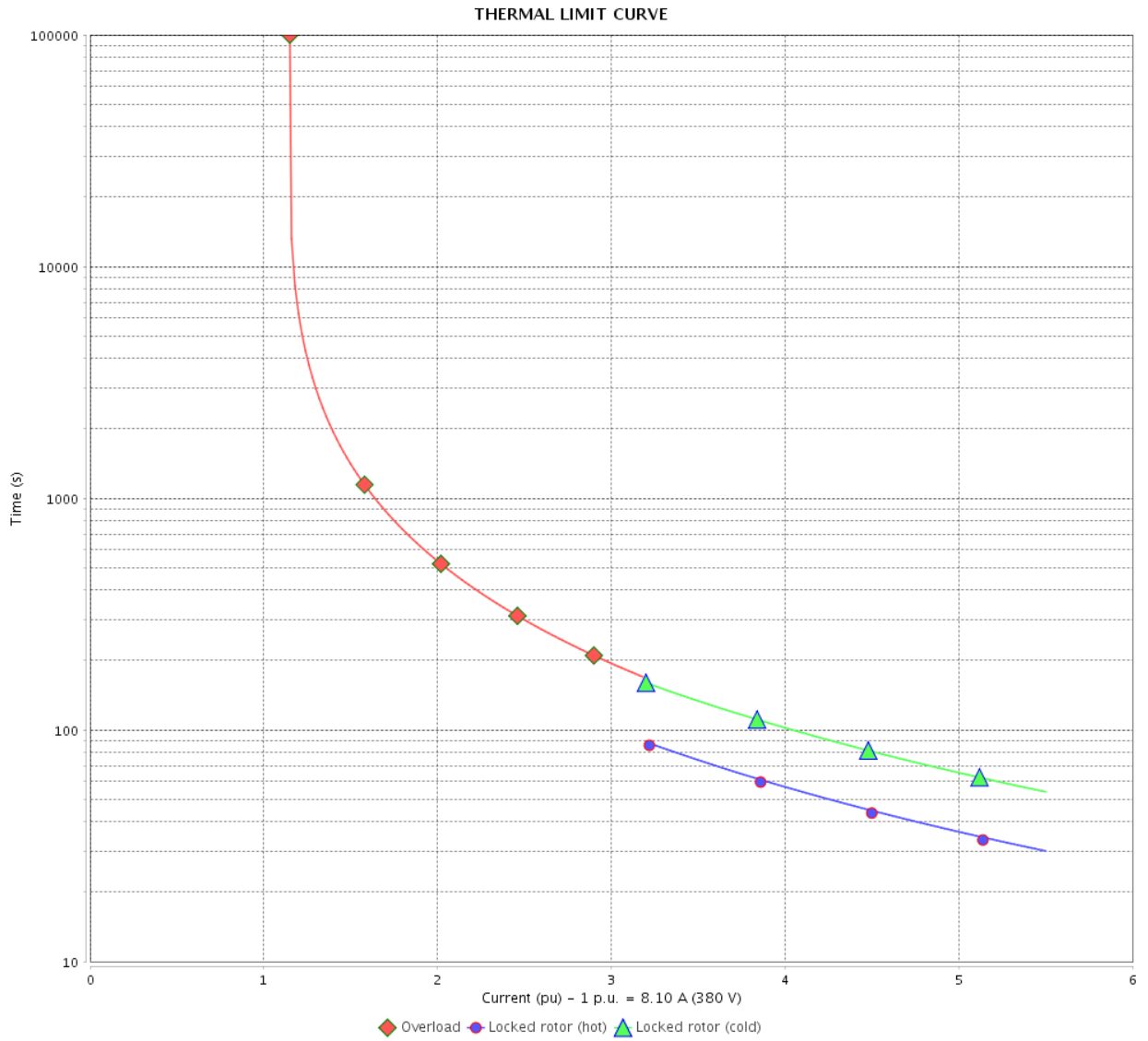

Rev.	Changes Summary	Performed	Checked	Date
Performed by		Page		Revision
Checked by		13 / 21		
Date		12/04/2022		

THERMAL LIMIT CURVE

Three Phase Induction Motor - Squirrel Cage



Customer :

Product line : NEMA Premium Efficiency Three-Phase
Product code : 12132187
Catalog # : 00512ET3E215JM-W22

Performance : 400 V 50 Hz 6P IE3

Rated current	: 7.82 A	Moment of inertia (J)	: 1.47 sq.ft.lb
LRC	: 6.1	Duty cycle	: Cont.(S1)
Rated torque	: 27.2 ft.lb	Insulation class	: F
Locked rotor torque	: 160 %	Service factor	: 1.00
Breakdown torque	: 229 %	Temperature rise	: 80 K
Rated speed	: 965 rpm	Design	: B

Heating constant

Cooling constant

Rev.	Changes Summary	Performed	Checked	Date
Performed by				
Checked by			Page	Revision
Date	12/04/2022		14 / 21	

THERMAL LIMIT CURVE

Three Phase Induction Motor - Squirrel Cage



Customer : _____

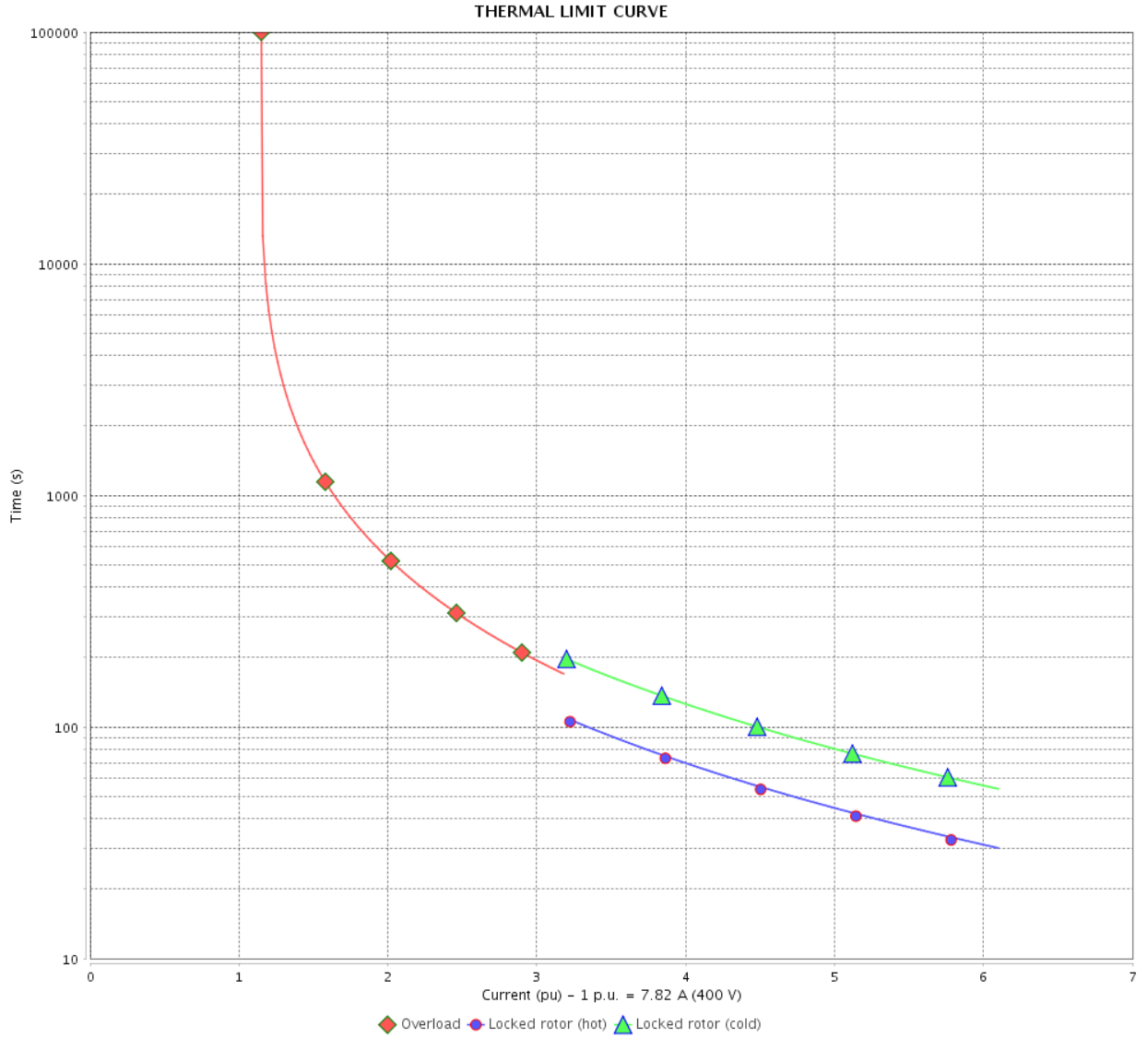

Rev.	Changes Summary	Performed	Checked	Date
Performed by		Page		Revision
Checked by		15 / 21		
Date		12/04/2022		

THERMAL LIMIT CURVE



Three Phase Induction Motor - Squirrel Cage

Customer :

Product line : NEMA Premium Efficiency Three-Phase
 Product code : 12132187
 Catalog # : 00512ET3E215JM-W22

Performance : 415 V 50 Hz 6P IE3

Rated current : 7.55 A	Moment of inertia (J) : 1.47 sq.ft.lb
LRC : 6.5	Duty cycle : Cont.(S1)
Rated torque : 27.1 ft.lb	Insulation class : F
Locked rotor torque : 190 %	Service factor : 1.00
Breakdown torque : 250 %	Temperature rise : 80 K
Rated speed : 970 rpm	Design : B

Heating constant

Cooling constant

Rev.	Changes Summary	Performed	Checked	Date
Performed by			Page 16 / 21	Revision
Checked by				
Date	12/04/2022			

THERMAL LIMIT CURVE

Three Phase Induction Motor - Squirrel Cage



Customer : _____

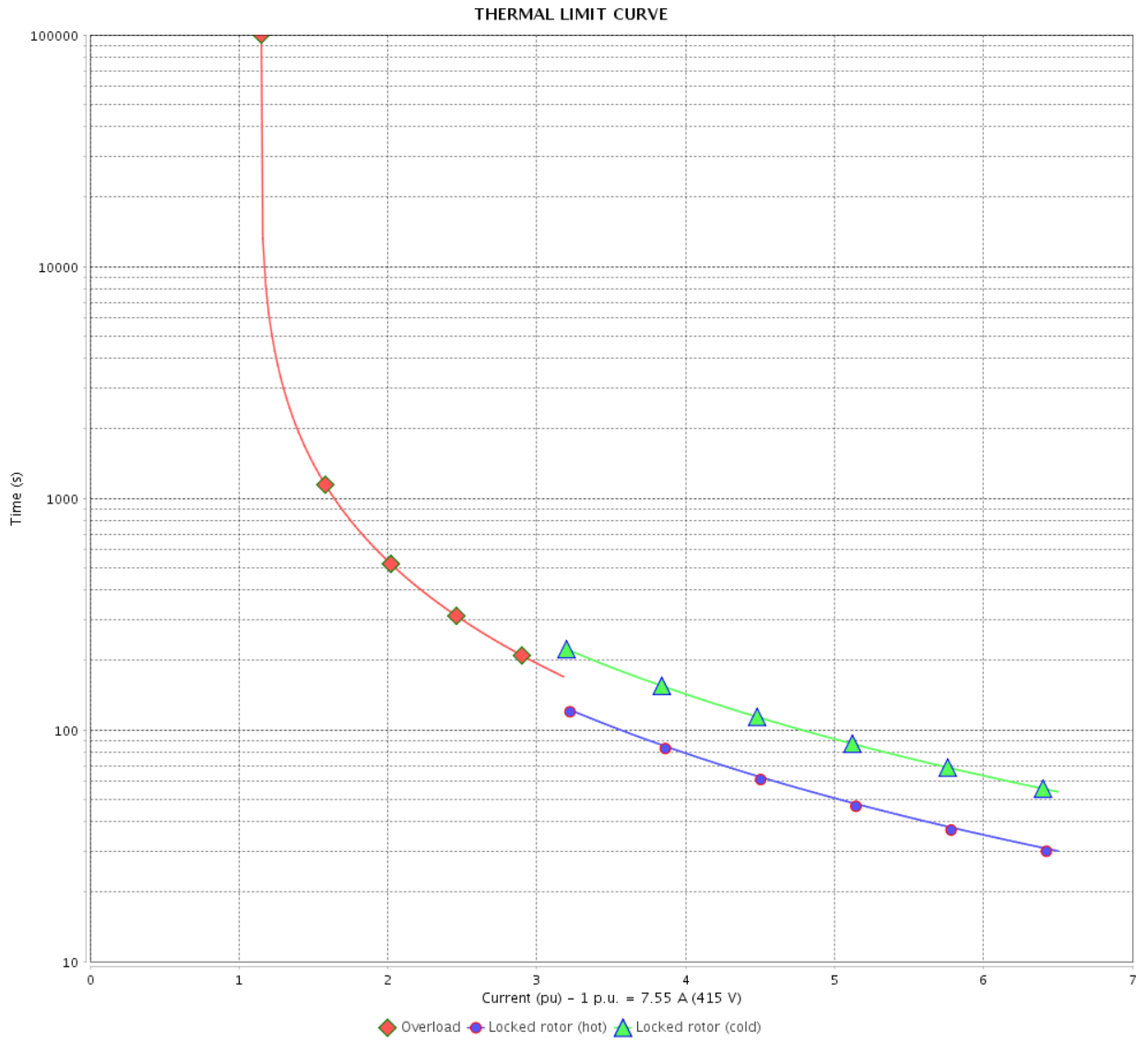

Rev.	Changes Summary	Performed	Checked	Date
Performed by		Page 17 / 21		Revision
Checked by				
Date				

VFD OPERATION CURVE

Three Phase Induction Motor - Squirrel Cage



Customer :

Product line : NEMA Premium Efficiency Three-Phase

Product code : 12132187

Catalog # : 00512ET3E215JM-W22

VFD OPERATION CURVE

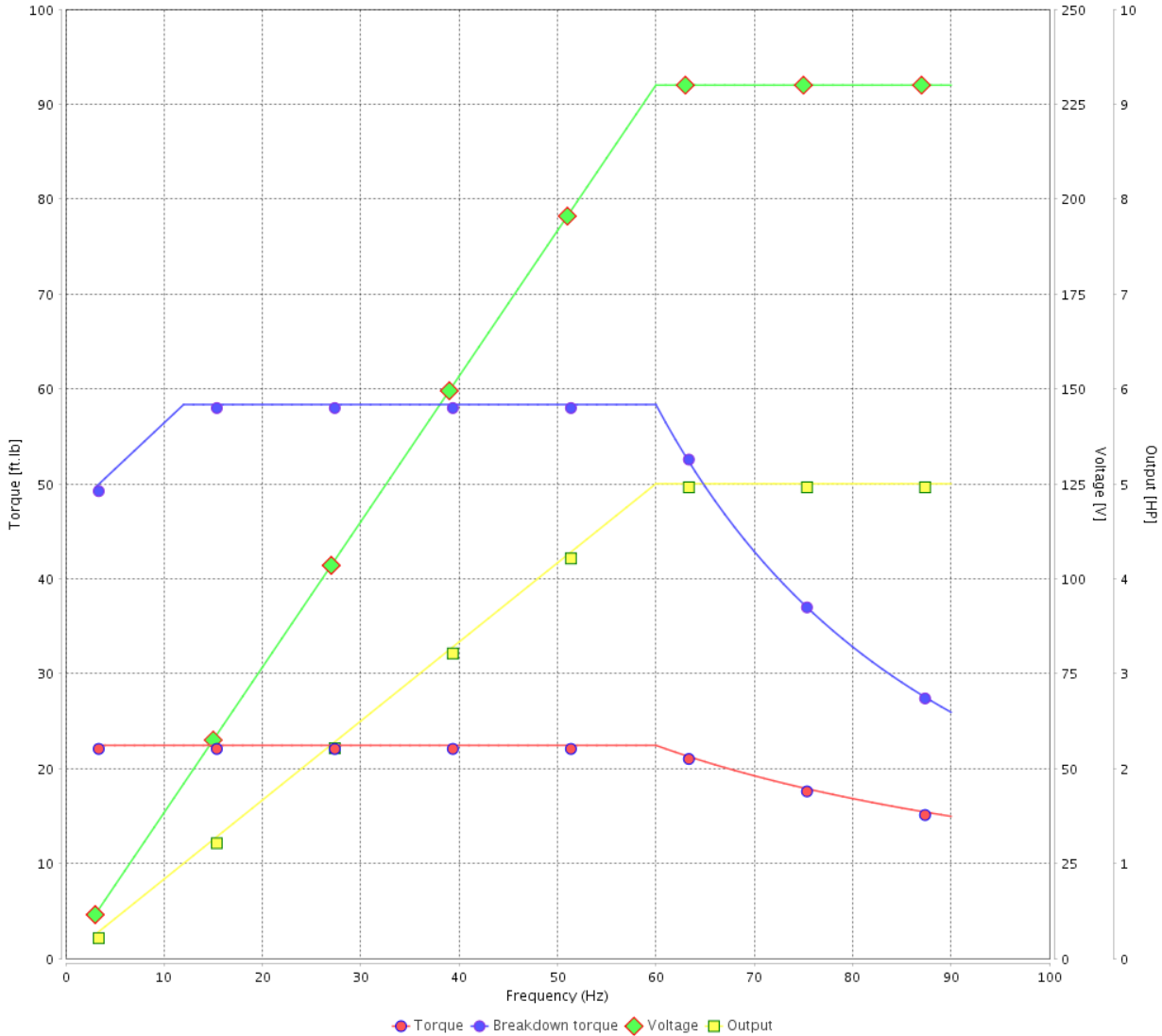

Performance : 230/460 V 60 Hz 6P

Rated current : 13.7/6.83 A
 LRC : 6.8
 Rated torque : 22.4 ft.lb
 Locked rotor torque : 170 %
 Breakdown torque : 260 %
 Rated speed : 1170 rpm

Moment of inertia (J) : 1.47 sq.ft.lb
 Duty cycle : Cont.(S1)
 Insulation class : F
 Service factor : 1.25
 Temperature rise : 80 K
 Design : B

Rev.	Changes Summary	Performed	Checked	Date
Performed by			Page 18 / 21	Revision
Checked by				
Date	12/04/2022			

VFD OPERATION CURVE

Three Phase Induction Motor - Squirrel Cage



Customer :

Product line : NEMA Premium Efficiency Three-Phase
 Product code : 12132187
 Catalog # : 00512ET3E215JM-W22

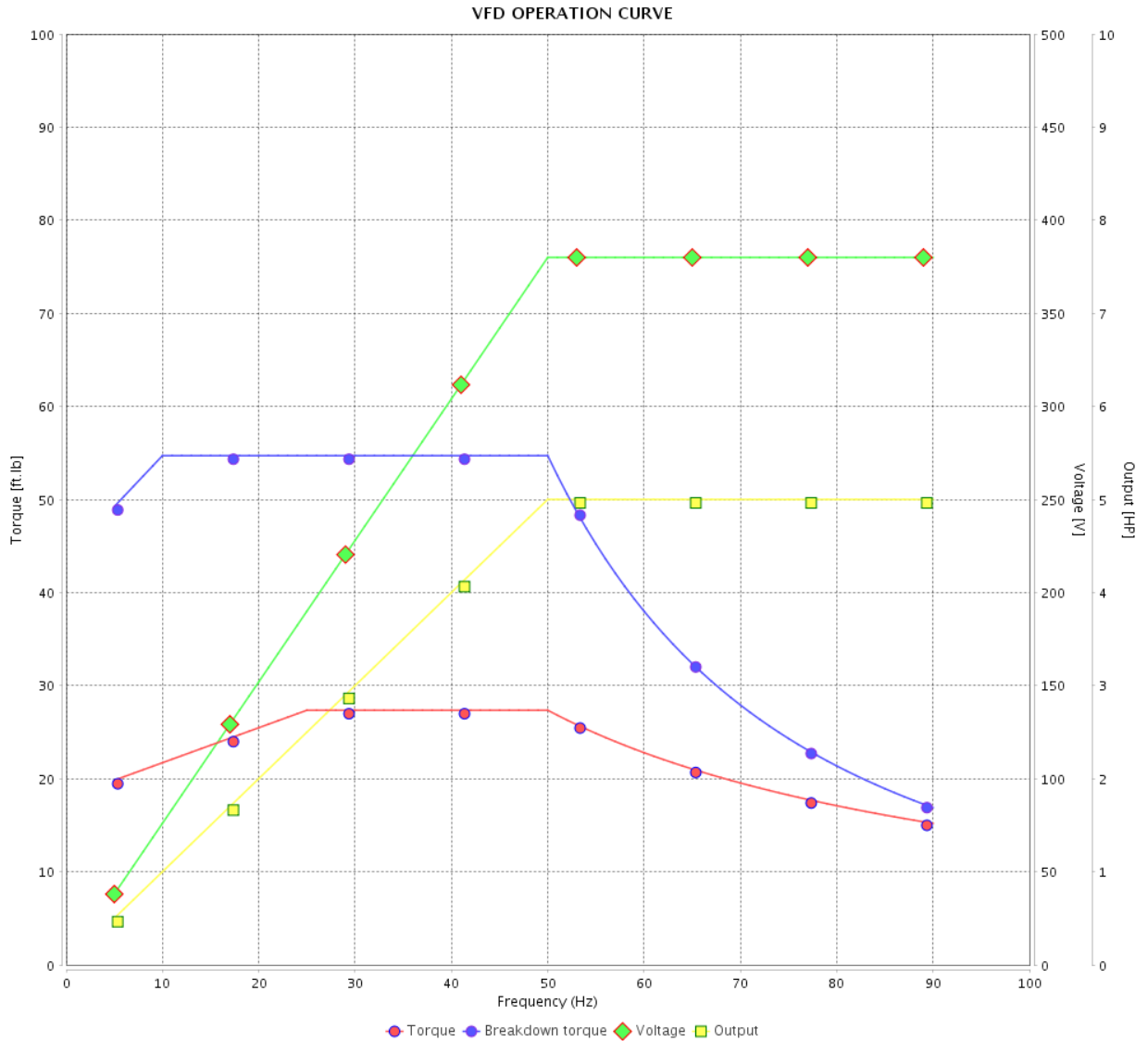

Performance : 380 V 50 Hz 6P IE3

Rated current : 8.10 A	Moment of inertia (J) : 1.47 sq.ft.lb
LRC : 5.5	Duty cycle : Cont.(S1)
Rated torque : 27.4 ft.lb	Insulation class : F
Locked rotor torque : 140 %	Service factor : 1.00
Breakdown torque : 200 %	Temperature rise : 80 K
Rated speed : 960 rpm	Design : B

Rev.	Changes Summary	Performed	Checked	Date
Performed by				Page 19 / 21
Checked by				
Date	12/04/2022			
				Revision

VFD OPERATION CURVE

Three Phase Induction Motor - Squirrel Cage



Customer :

Product line : NEMA Premium Efficiency Three-Phase

Product code : 12132187

Catalog # : 00512ET3E215JM-W22

VFD OPERATION CURVE

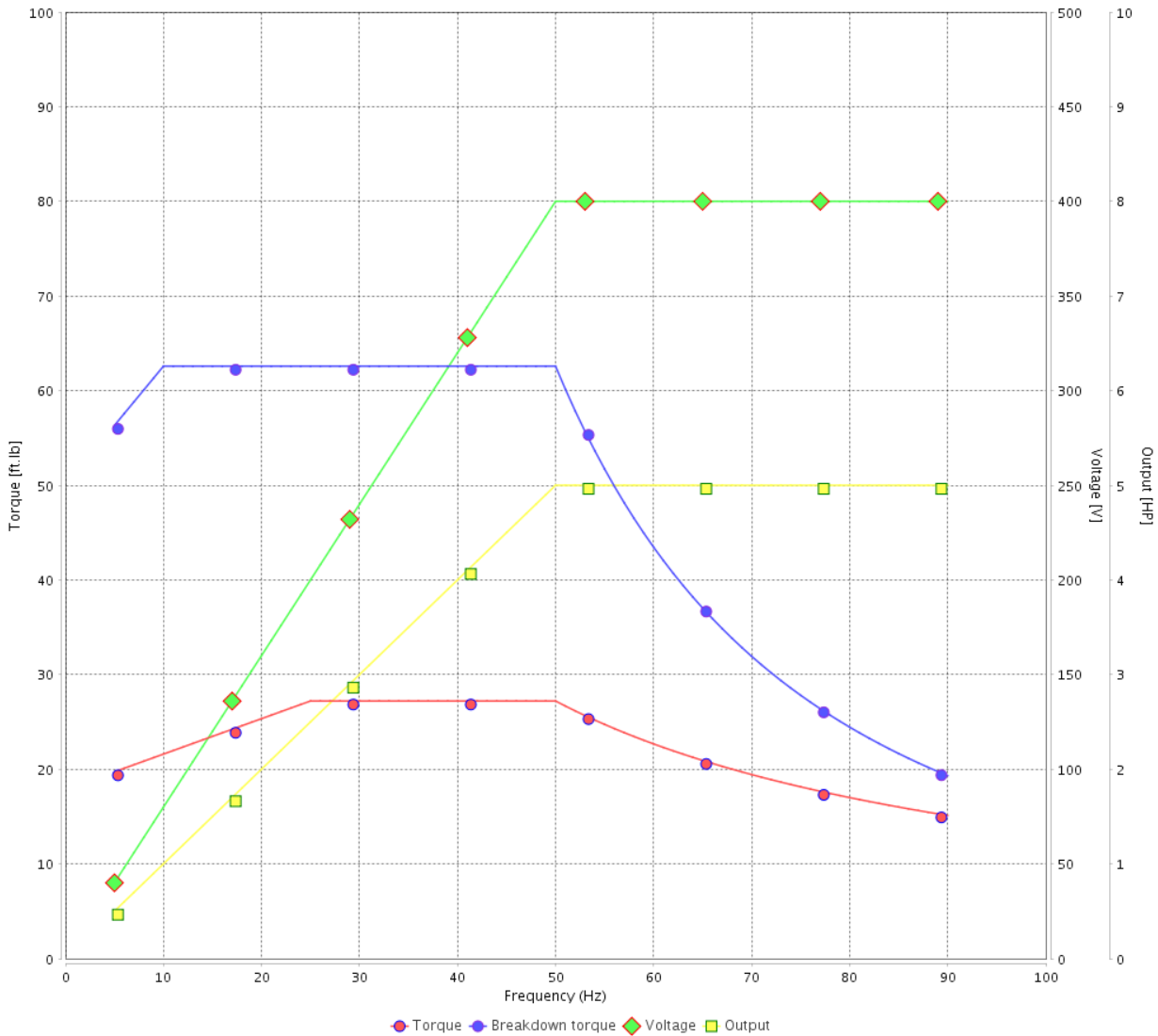

Performance : 400 V 50 Hz 6P IE3

Rated current	: 7.82 A	Moment of inertia (J)	: 1.47 sq.ft.lb
LRC	: 6.1	Duty cycle	: Cont.(S1)
Rated torque	: 27.2 ft.lb	Insulation class	: F
Locked rotor torque	: 160 %	Service factor	: 1.00
Breakdown torque	: 229 %	Temperature rise	: 80 K
Rated speed	: 965 rpm	Design	: B

Rev.	Changes Summary	Performed	Checked	Date
Performed by			Page 20 / 21	Revision
Checked by				
Date	12/04/2022			

VFD OPERATION CURVE

Three Phase Induction Motor - Squirrel Cage



Customer :

Product line : NEMA Premium Efficiency Three-Phase

Product code : 12132187

Catalog # : 00512ET3E215JM-W22

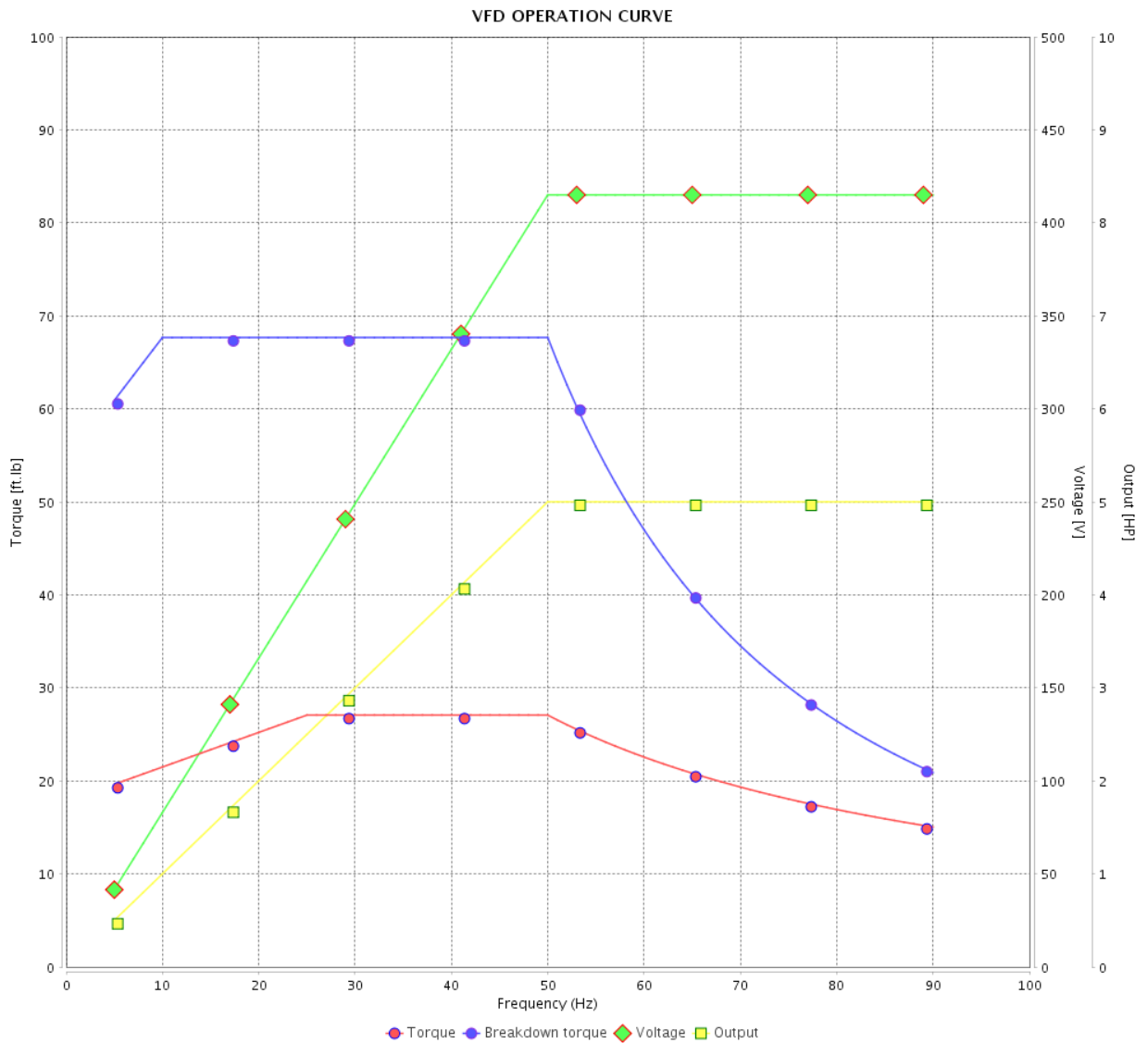

Performance : 415 V 50 Hz 6P IE3

Rated current : 7.55 A
 LRC : 6.5
 Rated torque : 27.1 ft.lb
 Locked rotor torque : 190 %
 Breakdown torque : 250 %
 Rated speed : 970 rpm

Moment of inertia (J) : 1.47 sq.ft.lb
 Duty cycle : Cont.(S1)
 Insulation class : F
 Service factor : 1.00
 Temperature rise : 80 K
 Design : B

Rev.	Changes Summary	Performed	Checked	Date
Performed by				Page 21 / 21
Checked by				
Date	12/04/2022			
				Revision

1 2 3 4 5 6

A

B

C

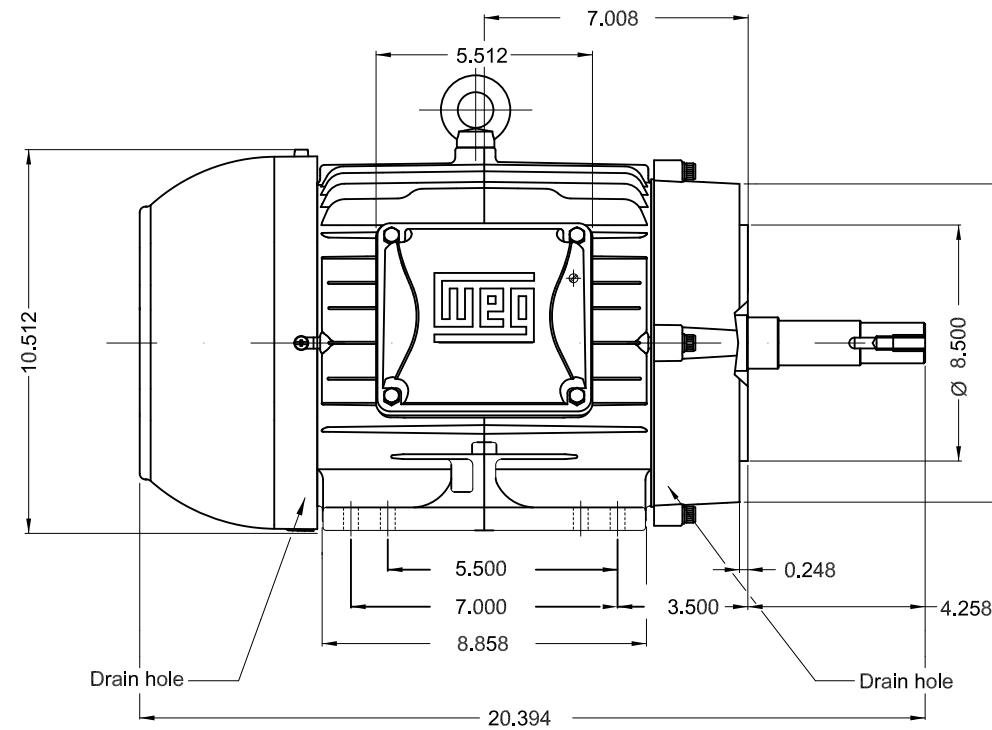
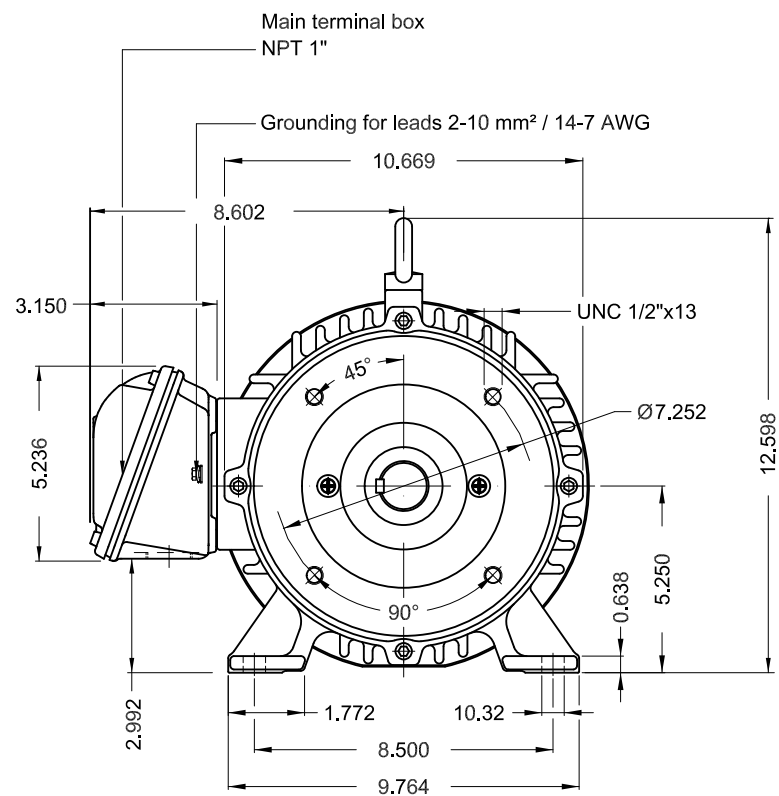

D

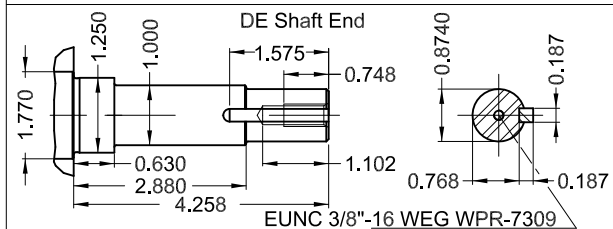

E

Color RAL 5009
 Painting plan 207A
 Mounting B34R(D)

5 HP 06 Poles 60 Hz

A

ECM	LOC	SUMMARY OF MODIFICATIONS	EXECUTED	CHECKED	RELEASED	DATE	VER
EXECUTED	PIRWBUSER	THREE PH. MOTOR JM/JP/JET PUMP W22 PREM. EFF.					
CHECKED		FRAME 213/5JM IP55 TEFC					
RELEASED							
REL DT.	WMO	Jaragua do Sul	Product Engineering	SHEET	1 / 1		

PREVIEW
 WDD



Dimensions in inches

XME A3

**W22**

CC029A

® Inverter Duty Motor
Severe Duty

12132187

MADE IN BRAZIL MODEL 00512ET3E215JM-W22

PH 3	FR 213/5JM	HP(kW) 5.0(3.7)	Hz 60	SF 1.25	PF 0.76
V 230/460	A 13.7/6.83	RPM 1170	INS. CL. F	ΔT 80 K	IP55
NEMA NOM EFF 89.5 %				DES B	DUTY CONT.
				AMB 40°C	
ENCL TEFC	SFA 17.1/8.54	USABLE @208V 15.1 A	SF 1.15	SFA 17.4	
5.0HP 3.7kW 50Hz 380V 8.10A 960RPM SF1.00 EFF 86.8% (IE3)					CODE J

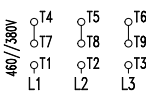
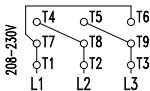

→ 6309-Z-C3

→ 6207-ZZ

MOBIL POLYREX EM

13 g 20000 h

ALT 1000 m.a.s.l. | 179 Lbs

For 60Hz: Class I, Div 2, Gr. A, B, C and D - T3

Class I, Zone 2, IIC - T3

Class II, Div 2, Gr. F and G - T4

For use on PWM, Gr. A, B, C, D and F

VT 1000:1, CT 20:1, 1.0SF, T3A

FOR SAFE AREA
MOD.TE1BFOXON