

DATA SHEET

Three Phase Induction Motor - Squirrel Cage



Customer					
Product line		: NEMA Premium Efficiency Three-Phase		Product code : 11606439	
				Catalog # : 00512ET3E215TC-W22	
Frame : 213/5TC		Cooling method : IC411 - TEFC			
Insulation class : F		Mounting : F-1			
Duty cycle : Cont.(S1)		Rotation ¹ : Both (CW and CCW)			
Ambient temperature : -20°C to +40°C		Starting method : Direct On Line			
Altitude : 1000 m.a.s.l.		Approx. weight ² : 175 lb			
Protection degree : IP55		Moment of inertia (J) : 1.47 sq.ft.lb			
Design : B					
Output [HP]	5	5	5	5	
Poles	6	6	6	6	
Frequency [Hz]	60	50	50	50	
Rated voltage [V]	230/460	380	400	415	
Rated current [A]	13.7/6.83	8.10	7.82	7.55	
L. R. Amperes [A]	92.9/46.4	44.5	47.7	49.1	
LRC [A]	6.8x(Code J)	5.5x(Code G)	6.1x(Code H)	6.5x(Code H)	
No load current [A]	6.90/3.45	3.41	3.68	3.90	
Rated speed [RPM]	1170	960	965	970	
Slip [%]	2.50	4.00	3.50	3.00	
Rated torque [ft.lb]	22.4	27.4	27.2	27.1	
Locked rotor torque [%]	170	140	160	190	
Breakdown torque [%]	260	200	229	250	
Service factor	1.25	1.00	1.00	1.00	
Temperature rise	80 K	80 K	80 K	80 K	
Locked rotor time	102s (cold) 57s (hot)	54s (cold) 30s (hot)	54s (cold) 30s (hot)	54s (cold) 30s (hot)	
Noise level ²	55.0 dB(A)	53.0 dB(A)	53.0 dB(A)	53.0 dB(A)	
Efficiency (%)	25%	88.2	89.8	89.1	87.2
	50%	88.5	88.5	88.5	87.5
	75%	89.5	88.5	88.5	88.5
	100%	89.5	86.8	87.5	88.5
Power Factor	25%	0.34	0.40	0.37	0.34
	50%	0.58	0.65	0.61	0.58
	75%	0.70	0.76	0.73	0.71
	100%	0.76	0.80	0.78	0.77
Bearing type		Drive end : 6308 ZZ	Non drive end : 6207 ZZ	Foundation loads	
Sealing		: V'Ring	: V'Ring	Max. traction : 294 lb	
Lubrication interval		: -	: -	Max. compression : 469 lb	
Lubricant amount		: -	: -		
Lubricant type		: Mobil Polyrex EM			
Notes					
USABLE @208V 15.1A SF 1.15 SFA 17.4A					
This revision replaces and cancel the previous one, which must be eliminated. (1) Looking the motor from the shaft end. (2) Measured at 1m and with tolerance of +3dB(A). (3) Approximate weight subject to changes after manufacturing process. (4) At 100% of full load.			These are average values based on tests with sinusoidal power supply, subject to the tolerances stipulated in NEMA MG-1.		
Rev.	Changes Summary		Performed	Checked	Date
Performed by					
Checked by				Page	Revision
Date	12/04/2022			1 / 21	

TORQUE AND CURRENT VS SPEED CURVE

Three Phase Induction Motor - Squirrel Cage



Customer :

Product line : NEMA Premium Efficiency Three-Phase

Product code : 11606439

Catalog # : 00512ET3E215TC-W22

TORQUE AND CURRENT VS SPEED CURVE

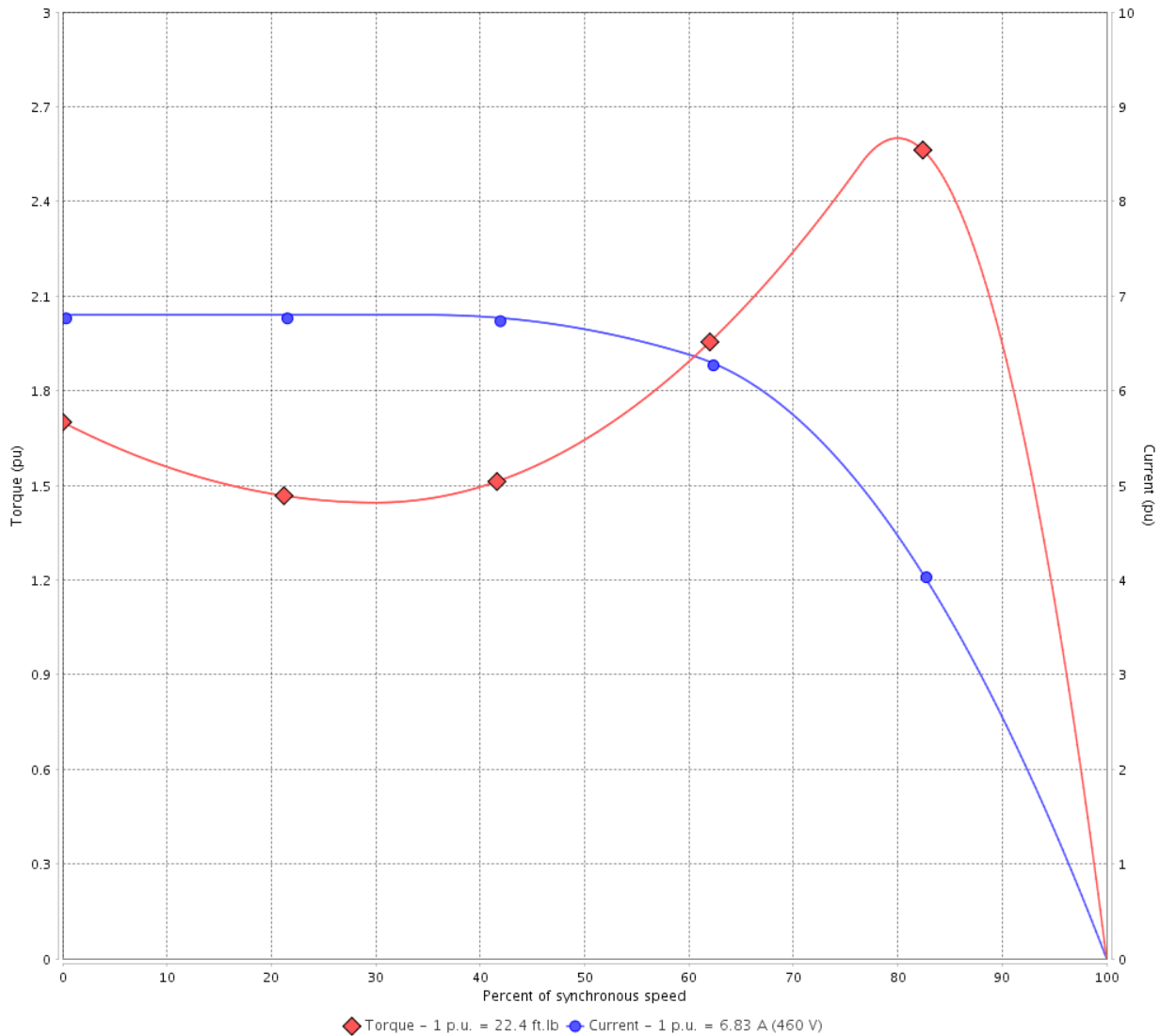

Performance : 230/460 V 60 Hz 6P

Rated current	: 13.7/6.83 A	Moment of inertia (J)	: 1.47 sq.ft.lb
LRC	: 6.8	Duty cycle	: Cont.(S1)
Rated torque	: 22.4 ft.lb	Insulation class	: F
Locked rotor torque	: 170 %	Service factor	: 1.25
Breakdown torque	: 260 %	Temperature rise	: 80 K
Rated speed	: 1170 rpm	Design	: B

Locked rotor time : 102s (cold) 57s (hot)

Rev.	Changes Summary	Performed	Checked	Date
Performed by			Page 2 / 21	Revision
Checked by				
Date	12/04/2022			

TORQUE AND CURRENT VS SPEED CURVE



Three Phase Induction Motor - Squirrel Cage

Customer :

Product line : NEMA Premium Efficiency Three-Phase

Product code : 11606439

Catalog # : 00512ET3E215TC-W22

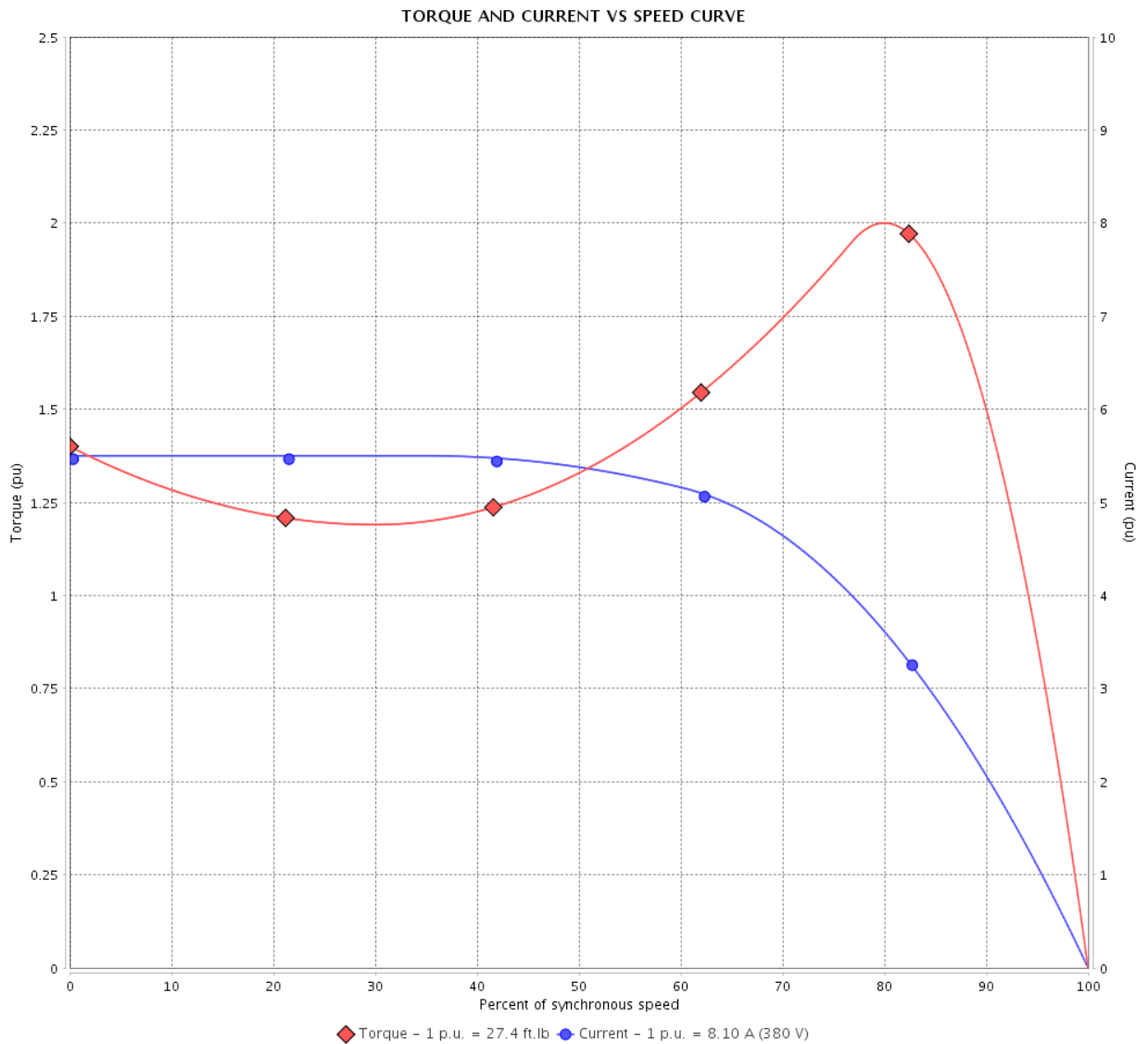

Performance : 380 V 50 Hz 6P IE3

Rated current	: 8.10 A	Moment of inertia (J)	: 1.47 sq.ft.lb
LRC	: 5.5	Duty cycle	: Cont.(S1)
Rated torque	: 27.4 ft.lb	Insulation class	: F
Locked rotor torque	: 140 %	Service factor	: 1.00
Breakdown torque	: 200 %	Temperature rise	: 80 K
Rated speed	: 960 rpm	Design	: B

Locked rotor time : 54s (cold) 30s (hot)

Rev.	Changes Summary	Performed	Checked	Date
Performed by			Page 3 / 21	Revision
Checked by				
Date	12/04/2022			

TORQUE AND CURRENT VS SPEED CURVE

Three Phase Induction Motor - Squirrel Cage



Customer :

Product line : NEMA Premium Efficiency Three-Phase

Product code : 11606439

Catalog # : 00512ET3E215TC-W22

TORQUE AND CURRENT VS SPEED CURVE

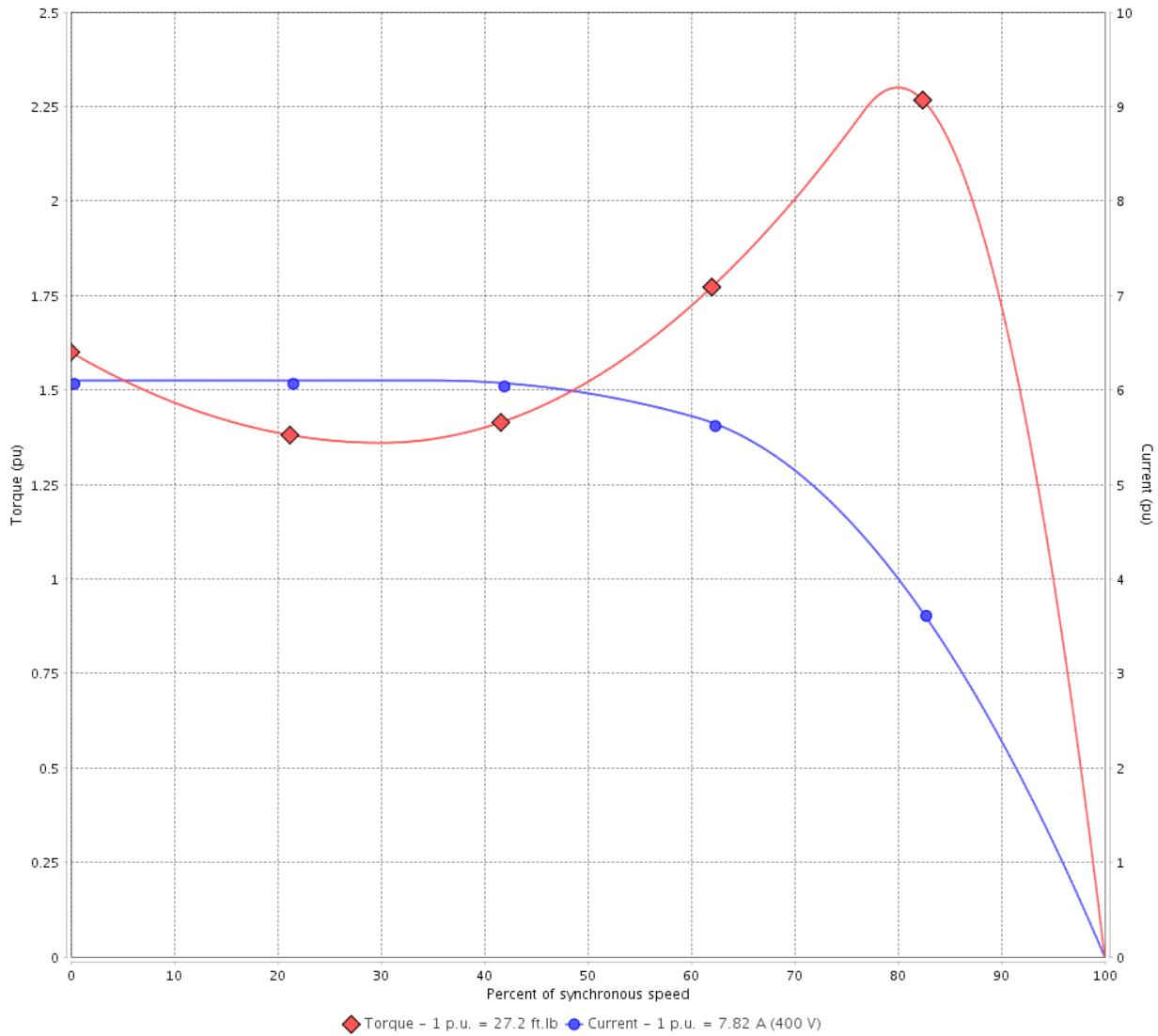

Performance : 400 V 50 Hz 6P IE3

Rated current	: 7.82 A	Moment of inertia (J)	: 1.47 sq.ft.lb
LRC	: 6.1	Duty cycle	: Cont.(S1)
Rated torque	: 27.2 ft.lb	Insulation class	: F
Locked rotor torque	: 160 %	Service factor	: 1.00
Breakdown torque	: 229 %	Temperature rise	: 80 K
Rated speed	: 965 rpm	Design	: B

Locked rotor time : 54s (cold) 30s (hot)

Rev.	Changes Summary	Performed	Checked	Date
Performed by			Page 4 / 21	Revision
Checked by				
Date	12/04/2022			

TORQUE AND CURRENT VS SPEED CURVE



Three Phase Induction Motor - Squirrel Cage

Customer :

Product line : NEMA Premium Efficiency Three-Phase

Product code : 11606439

Catalog # : 00512ET3E215TC-W22

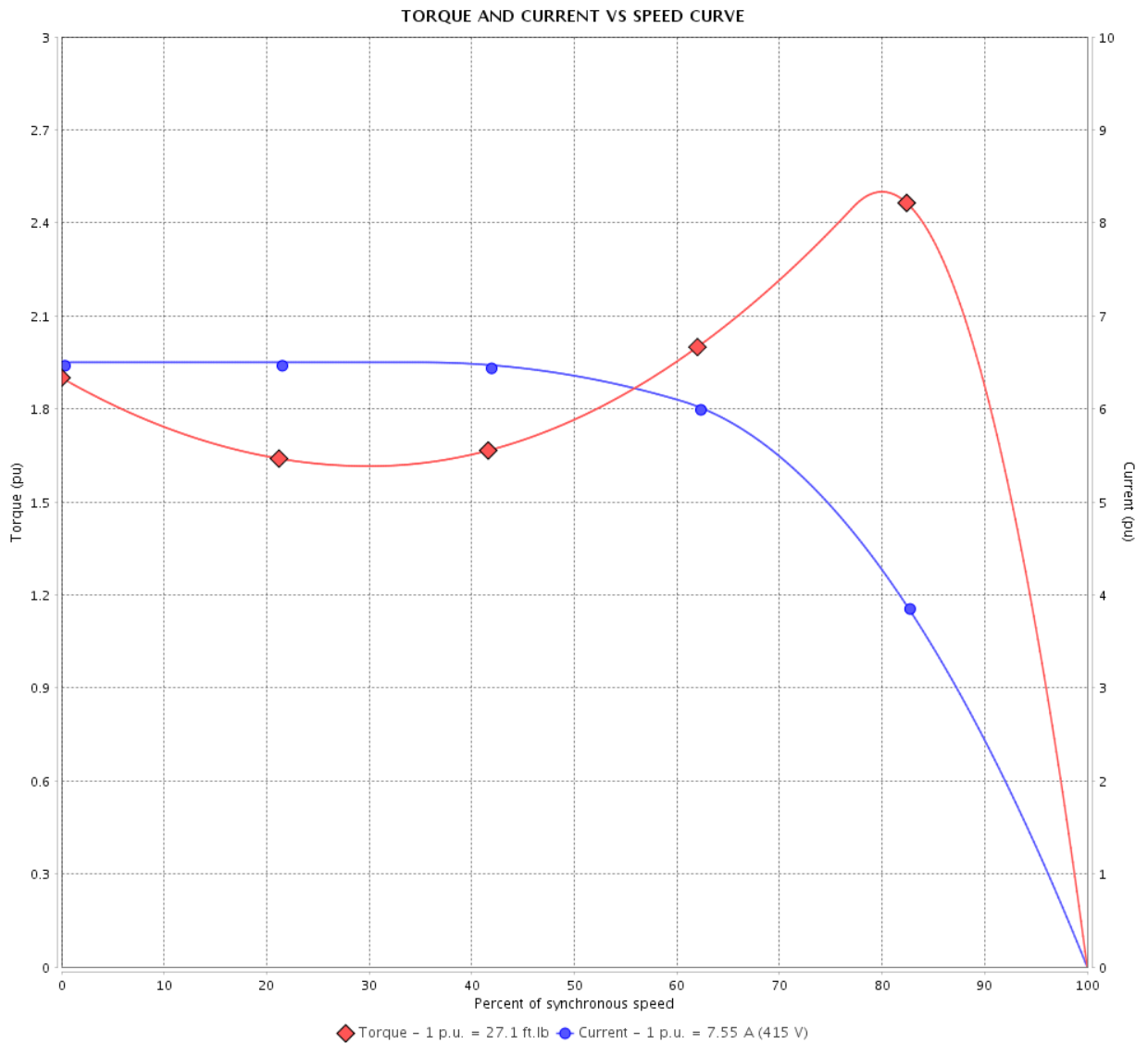

Performance : 415 V 50 Hz 6P IE3

Rated current	: 7.55 A	Moment of inertia (J)	: 1.47 sq.ft.lb
LRC	: 6.5	Duty cycle	: Cont.(S1)
Rated torque	: 27.1 ft.lb	Insulation class	: F
Locked rotor torque	: 190 %	Service factor	: 1.00
Breakdown torque	: 250 %	Temperature rise	: 80 K
Rated speed	: 970 rpm	Design	: B

Locked rotor time : 54s (cold) 30s (hot)

Rev.	Changes Summary	Performed	Checked	Date
Performed by			Page 5 / 21	Revision
Checked by				
Date	12/04/2022			

LOAD PERFORMANCE CURVE

Three Phase Induction Motor - Squirrel Cage



Customer :

Product line : NEMA Premium Efficiency Three-Phase

Product code : 11606439

Catalog # : 00512ET3E215TC-W22

LOAD PERFORMANCE CURVE

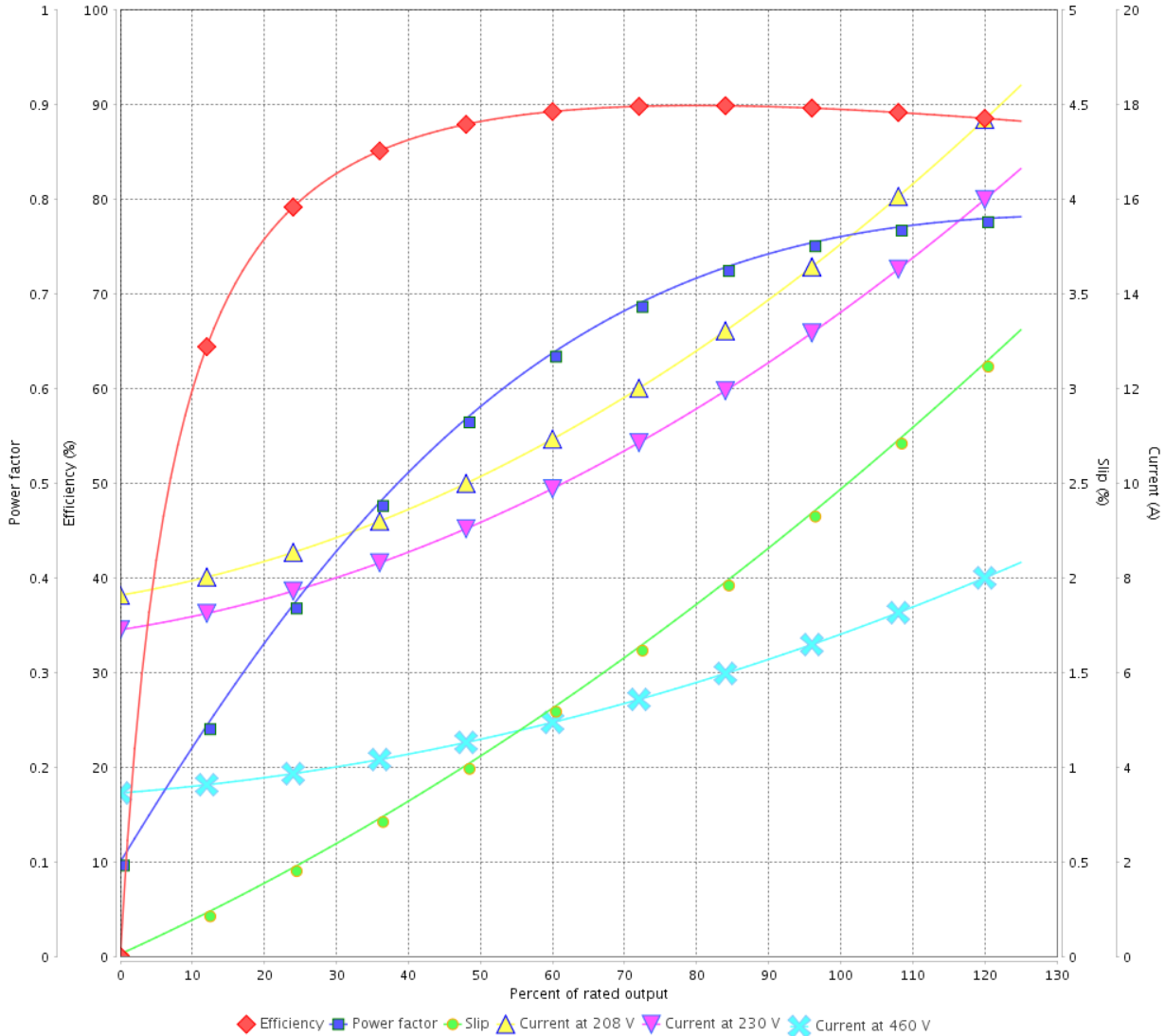

Performance : 230/460 V 60 Hz 6P

Rated current : 13.7/6.83 A
 LRC : 6.8
 Rated torque : 22.4 ft.lb
 Locked rotor torque : 170 %
 Breakdown torque : 260 %
 Rated speed : 1170 rpm

Moment of inertia (J) : 1.47 sq.ft.lb
 Duty cycle : Cont.(S1)
 Insulation class : F
 Service factor : 1.25
 Temperature rise : 80 K
 Design : B

Rev.	Changes Summary	Performed	Checked	Date
Performed by			Page	Revision
Checked by				
Date				

LOAD PERFORMANCE CURVE

Three Phase Induction Motor - Squirrel Cage



Customer : _____

Product line : NEMA Premium Efficiency Three-Phase

Product code : 11606439

Catalog # : 00512ET3E215TC-W22

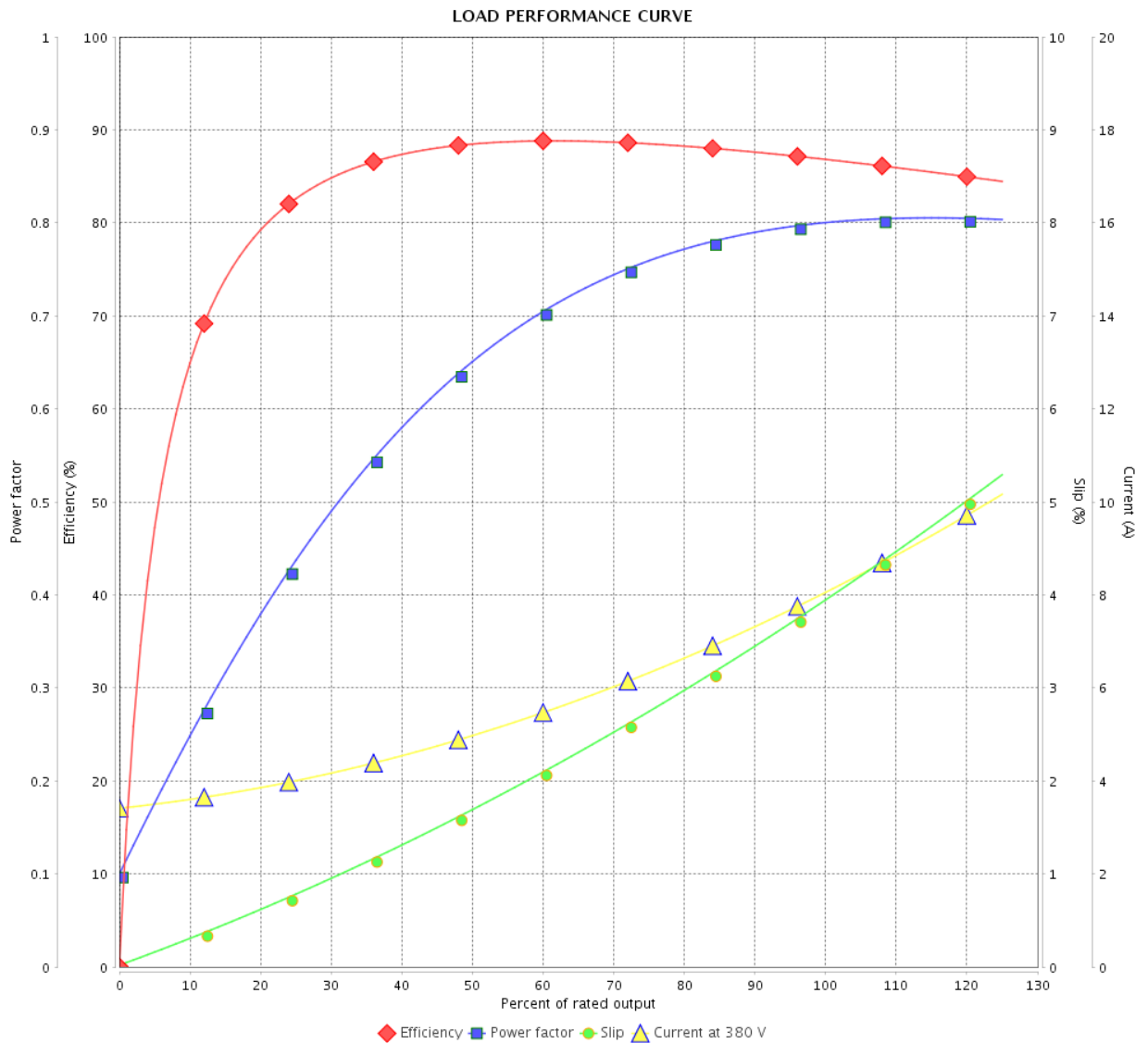

Performance : 380 V 50 Hz 6P IE3

Rated current : 8.10 A
 LRC : 5.5
 Rated torque : 27.4 ft.lb
 Locked rotor torque : 140 %
 Breakdown torque : 200 %
 Rated speed : 960 rpm

Moment of inertia (J) : 1.47 sq.ft.lb
 Duty cycle : Cont.(S1)
 Insulation class : F
 Service factor : 1.00
 Temperature rise : 80 K
 Design : B

Rev.	Changes Summary	Performed	Checked	Date
Performed by			Page 7 / 21	Revision
Checked by				
Date	12/04/2022			

LOAD PERFORMANCE CURVE

Three Phase Induction Motor - Squirrel Cage



Customer :

Product line : NEMA Premium Efficiency Three-Phase

Product code : 11606439

Catalog # : 00512ET3E215TC-W22

LOAD PERFORMANCE CURVE

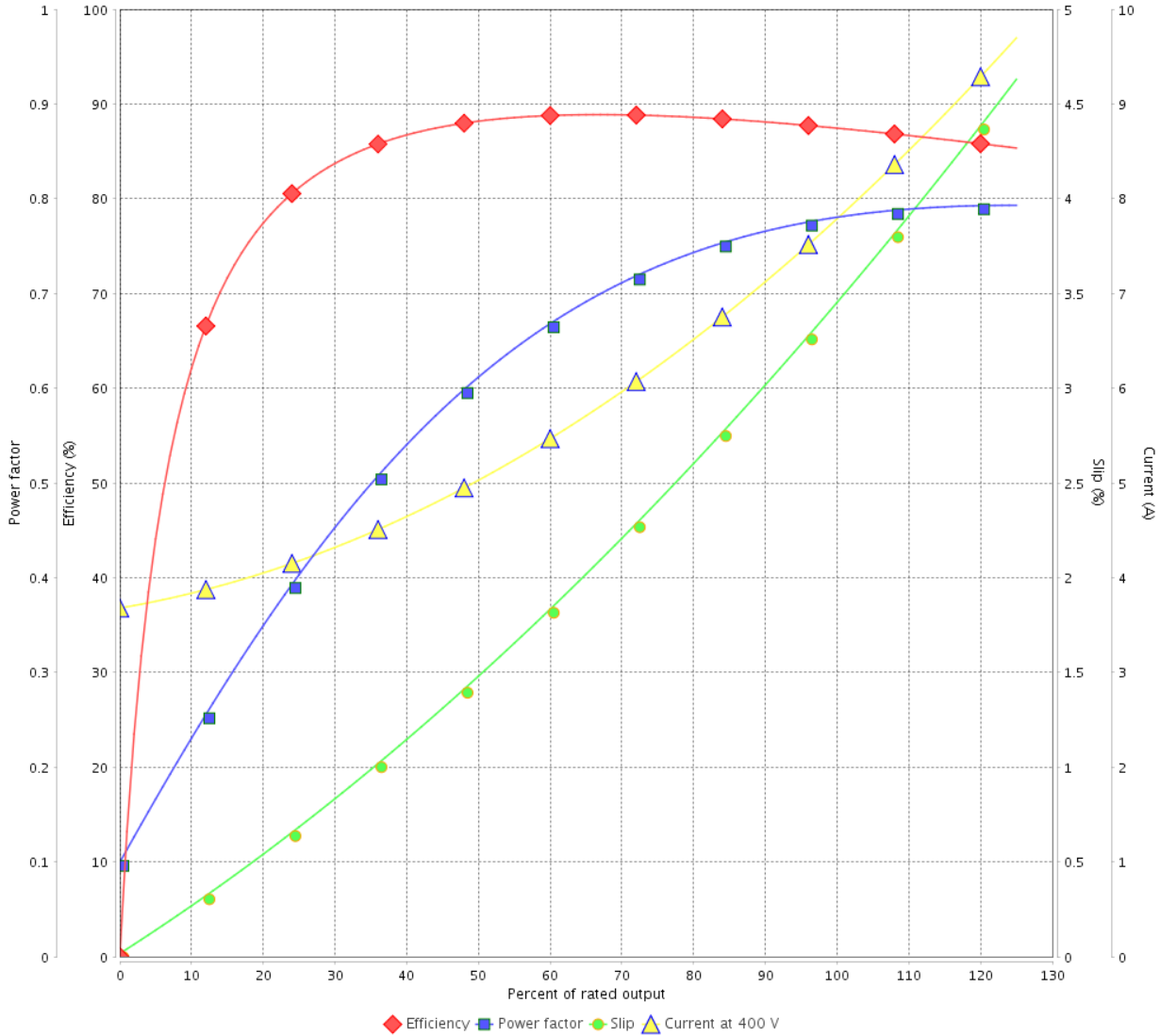

Performance : 400 V 50 Hz 6P IE3

Rated current : 7.82 A
 LRC : 6.1
 Rated torque : 27.2 ft.lb
 Locked rotor torque : 160 %
 Breakdown torque : 229 %
 Rated speed : 965 rpm

Moment of inertia (J) : 1.47 sq.ft.lb
 Duty cycle : Cont.(S1)
 Insulation class : F
 Service factor : 1.00
 Temperature rise : 80 K
 Design : B

Rev.	Changes Summary	Performed	Checked	Date
Performed by			Page 8 / 21	Revision
Checked by				
Date	12/04/2022			

LOAD PERFORMANCE CURVE

Three Phase Induction Motor - Squirrel Cage



Customer :

Product line : NEMA Premium Efficiency Three-Phase

Product code : 11606439

Catalog # : 00512ET3E215TC-W22

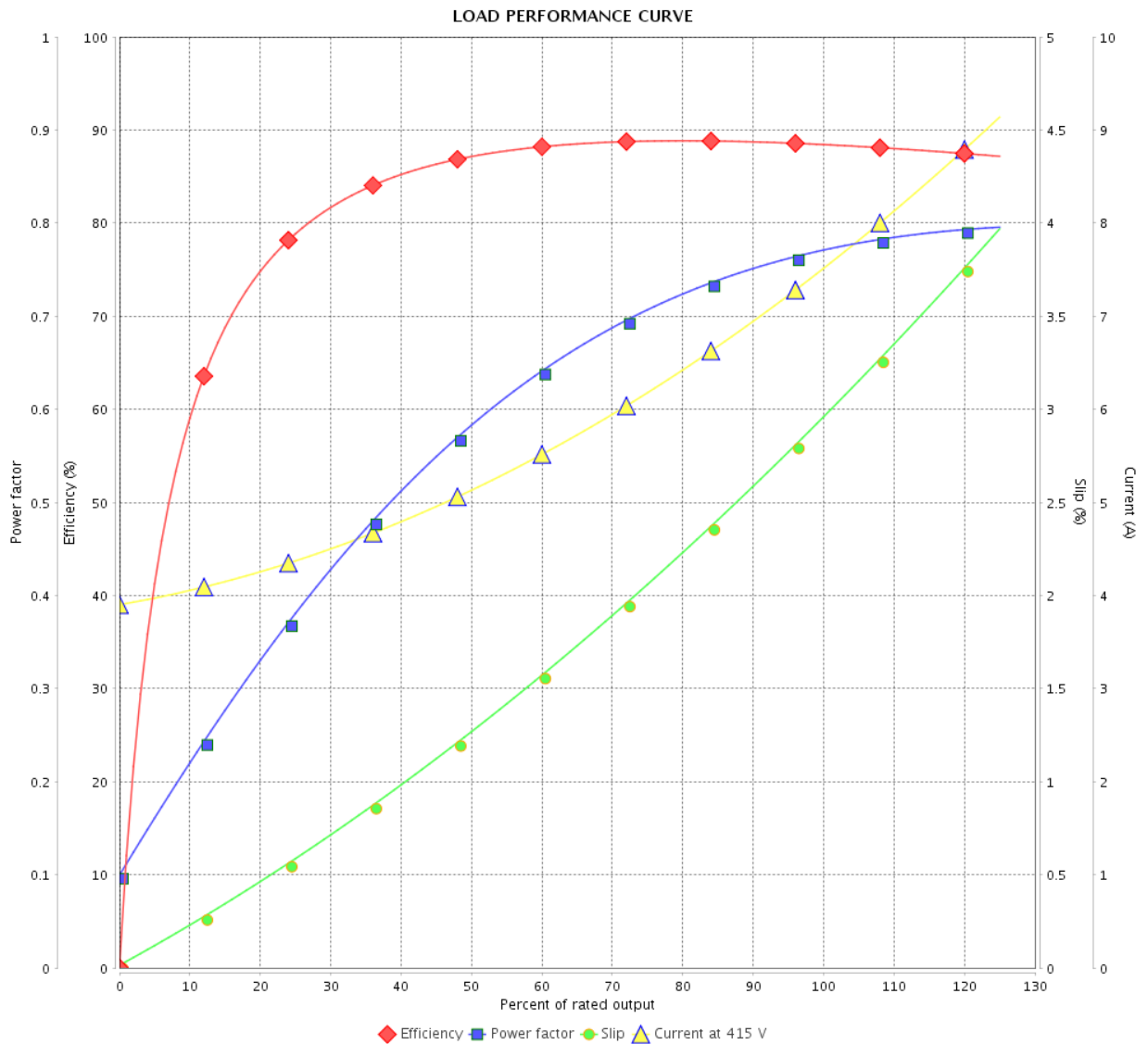

Performance : 415 V 50 Hz 6P IE3

Rated current : 7.55 A
 LRC : 6.5
 Rated torque : 27.1 ft.lb
 Locked rotor torque : 190 %
 Breakdown torque : 250 %
 Rated speed : 970 rpm

Moment of inertia (J) : 1.47 sq.ft.lb
 Duty cycle : Cont.(S1)
 Insulation class : F
 Service factor : 1.00
 Temperature rise : 80 K
 Design : B

Rev.	Changes Summary	Performed	Checked	Date
Performed by			Page	Revision
Checked by			9 / 21	
Date	12/04/2022			

THERMAL LIMIT CURVE



Three Phase Induction Motor - Squirrel Cage

Customer :

Product line : NEMA Premium Efficiency Three-Phase
 Product code : 11606439
 Catalog # : 00512ET3E215TC-W22

Performance : 230/460 V 60 Hz 6P

Rated current : 13.7/6.83 A	Moment of inertia (J) : 1.47 sq.ft.lb
LRC : 6.8	Duty cycle : Cont.(S1)
Rated torque : 22.4 ft.lb	Insulation class : F
Locked rotor torque : 170 %	Service factor : 1.25
Breakdown torque : 260 %	Temperature rise : 80 K
Rated speed : 1170 rpm	Design : B

Heating constant

Cooling constant

Rev.	Changes Summary	Performed	Checked	Date
Performed by			Page 10 / 21	Revision
Checked by				
Date	12/04/2022			

THERMAL LIMIT CURVE

Three Phase Induction Motor - Squirrel Cage



Customer : _____

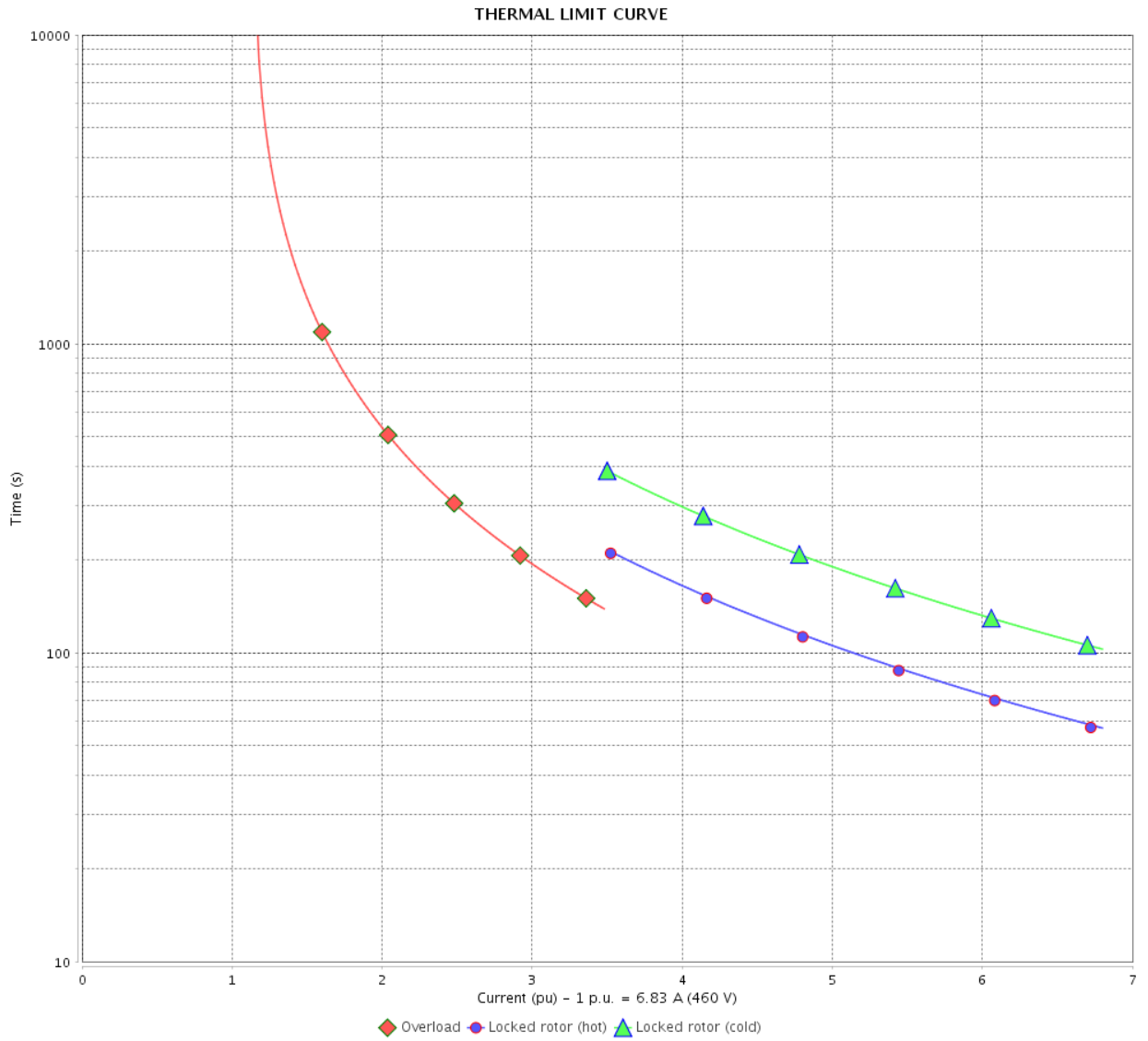

Rev.	Changes Summary	Performed	Checked	Date
Performed by		Page		Revision
Checked by		11 / 21		
Date		12/04/2022		

THERMAL LIMIT CURVE

Three Phase Induction Motor - Squirrel Cage



Customer :

Product line : NEMA Premium Efficiency Three-Phase
Product code : 11606439
Catalog # : 00512ET3E215TC-W22

Performance : 380 V 50 Hz 6P IE3

Rated current	: 8.10 A	Moment of inertia (J)	: 1.47 sq.ft.lb
LRC	: 5.5	Duty cycle	: Cont.(S1)
Rated torque	: 27.4 ft.lb	Insulation class	: F
Locked rotor torque	: 140 %	Service factor	: 1.00
Breakdown torque	: 200 %	Temperature rise	: 80 K
Rated speed	: 960 rpm	Design	: B

Heating constant

Cooling constant

Rev.	Changes Summary	Performed	Checked	Date
Performed by				
Checked by			Page	Revision
Date	12/04/2022		12 / 21	

THERMAL LIMIT CURVE

Three Phase Induction Motor - Squirrel Cage



Customer : _____

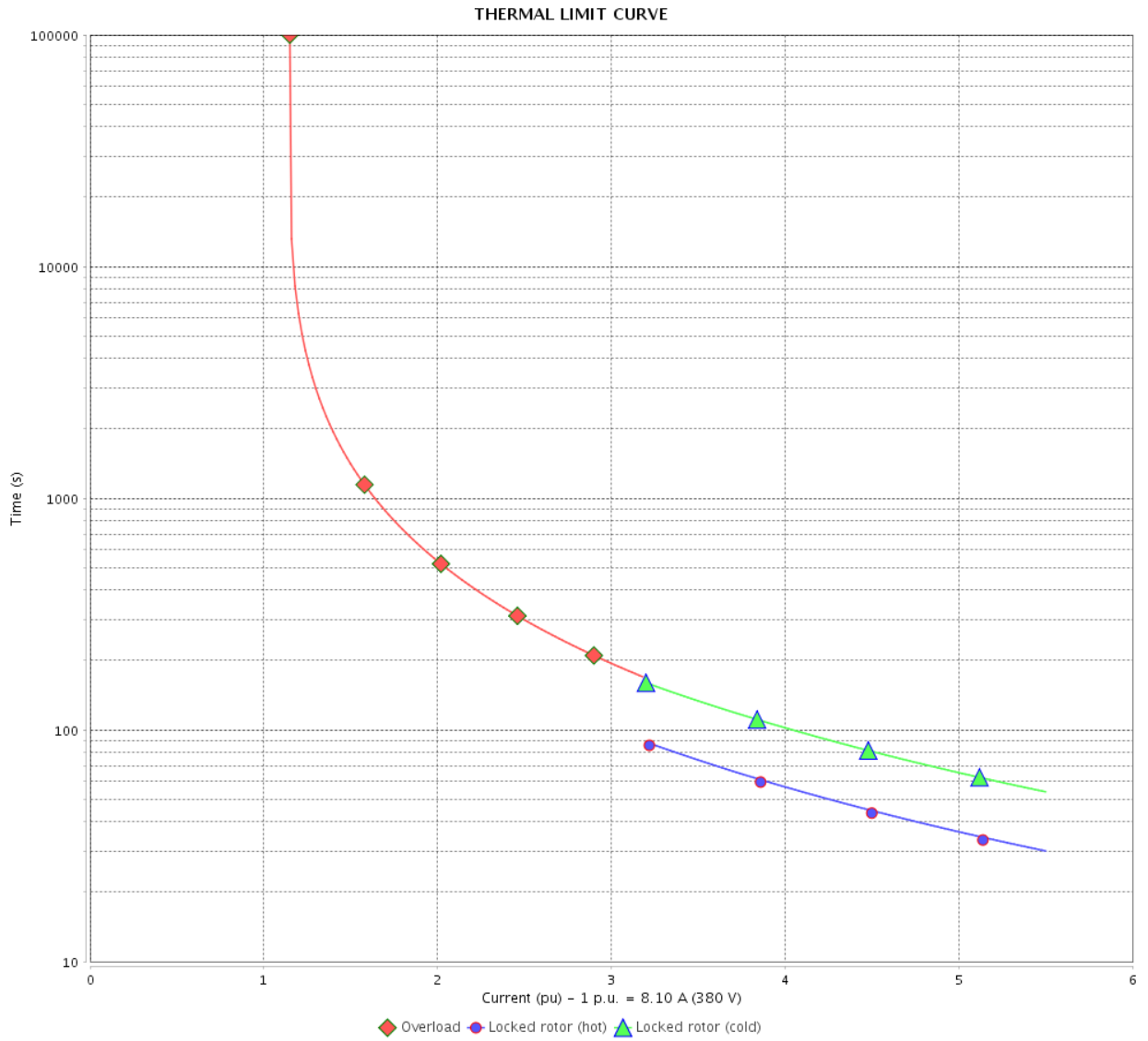

Rev.	Changes Summary	Performed	Checked	Date
Performed by		Page		Revision
Checked by		13 / 21		
Date		12/04/2022		

THERMAL LIMIT CURVE



Three Phase Induction Motor - Squirrel Cage

Customer :

Product line : NEMA Premium Efficiency Three-Phase
Product code : 11606439
Catalog # : 00512ET3E215TC-W22

Performance : 400 V 50 Hz 6P IE3

Rated current	: 7.82 A	Moment of inertia (J)	: 1.47 sq.ft.lb
LRC	: 6.1	Duty cycle	: Cont.(S1)
Rated torque	: 27.2 ft.lb	Insulation class	: F
Locked rotor torque	: 160 %	Service factor	: 1.00
Breakdown torque	: 229 %	Temperature rise	: 80 K
Rated speed	: 965 rpm	Design	: B

Heating constant

Cooling constant

Rev.	Changes Summary	Performed	Checked	Date
Performed by				
Checked by			Page	Revision
Date	12/04/2022		14 / 21	

THERMAL LIMIT CURVE

Three Phase Induction Motor - Squirrel Cage



Customer : _____

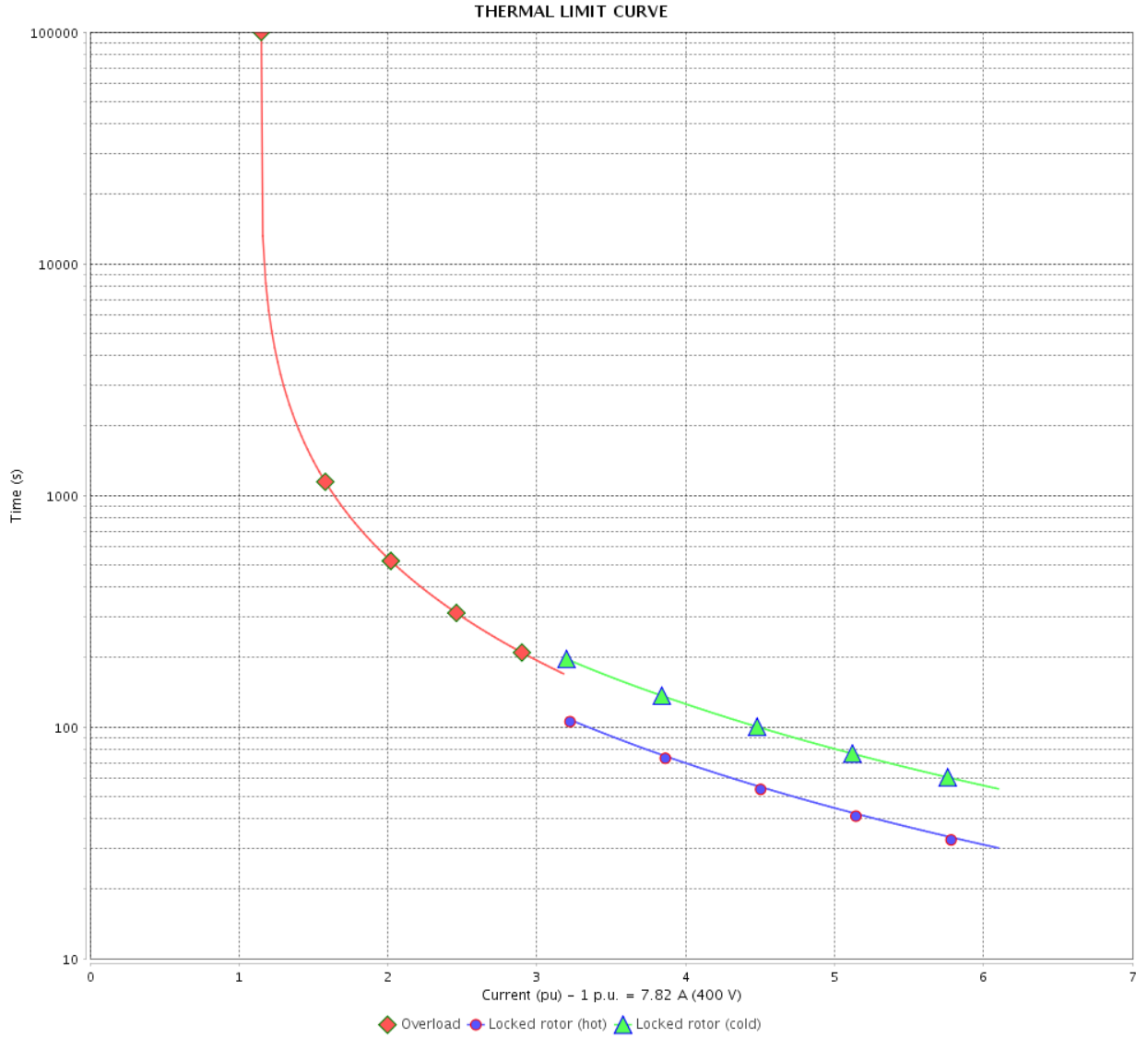

Rev.	Changes Summary	Performed	Checked	Date
Performed by		Page		Revision
Checked by		15 / 21		
Date		12/04/2022		

THERMAL LIMIT CURVE

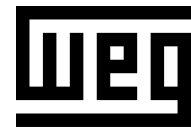

Three Phase Induction Motor - Squirrel Cage

Customer :

Product line : NEMA Premium Efficiency Three-Phase
Product code : 11606439
Catalog # : 00512ET3E215TC-W22

Performance : 415 V 50 Hz 6P IE3

Rated current	: 7.55 A	Moment of inertia (J)	: 1.47 sq.ft.lb
LRC	: 6.5	Duty cycle	: Cont.(S1)
Rated torque	: 27.1 ft.lb	Insulation class	: F
Locked rotor torque	: 190 %	Service factor	: 1.00
Breakdown torque	: 250 %	Temperature rise	: 80 K
Rated speed	: 970 rpm	Design	: B

Heating constant

Cooling constant

Rev.	Changes Summary	Performed	Checked	Date
Performed by				
Checked by			Page	Revision
Date	12/04/2022		16 / 21	

THERMAL LIMIT CURVE

Three Phase Induction Motor - Squirrel Cage



Customer : _____

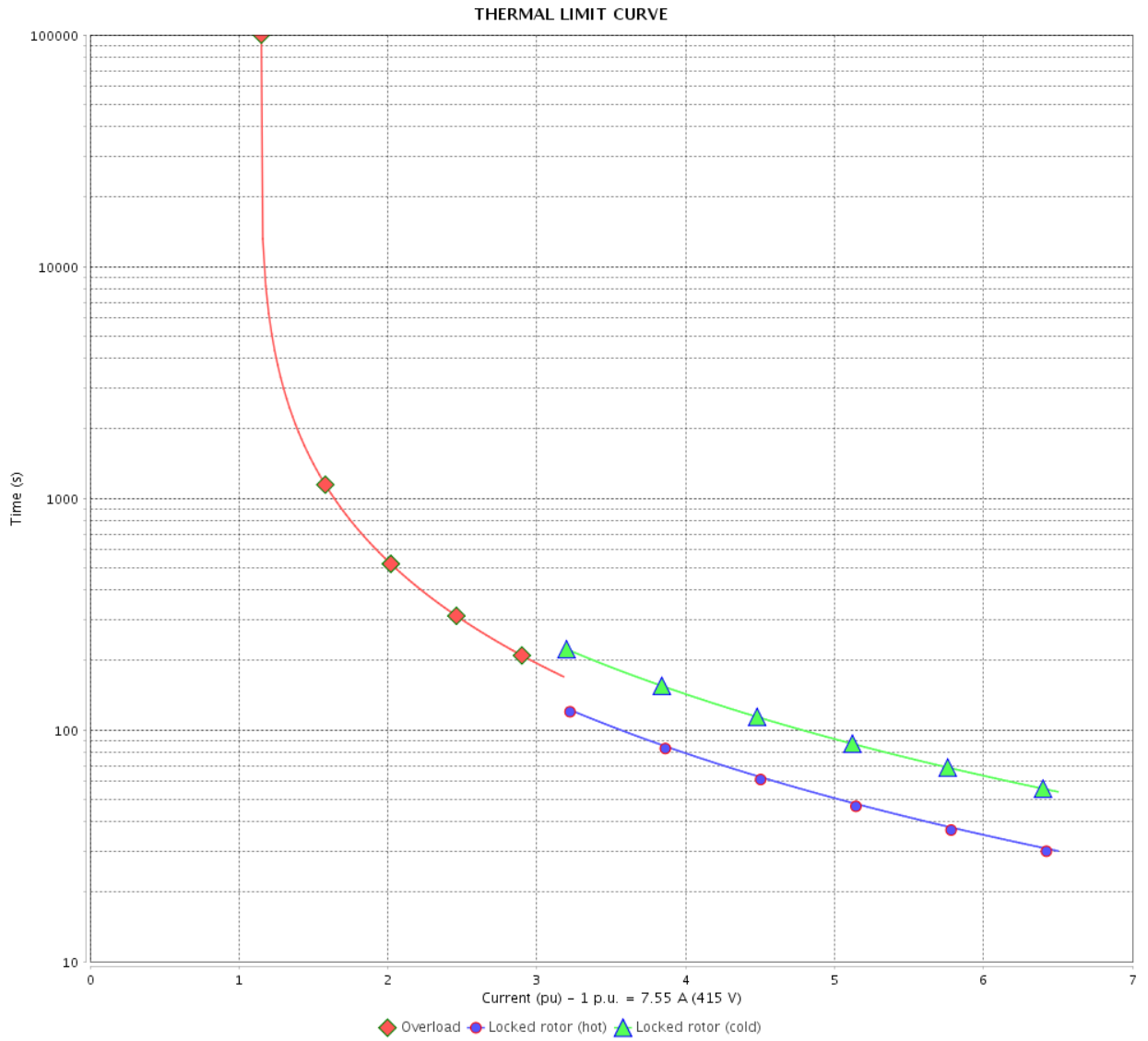

Rev.	Changes Summary	Performed	Checked	Date
Performed by		Page		Revision
Checked by		17 / 21		
Date		12/04/2022		

VFD OPERATION CURVE

Three Phase Induction Motor - Squirrel Cage



Customer :

Product line : NEMA Premium Efficiency Three-Phase

Product code : 11606439

Catalog # : 00512ET3E215TC-W22

VFD OPERATION CURVE

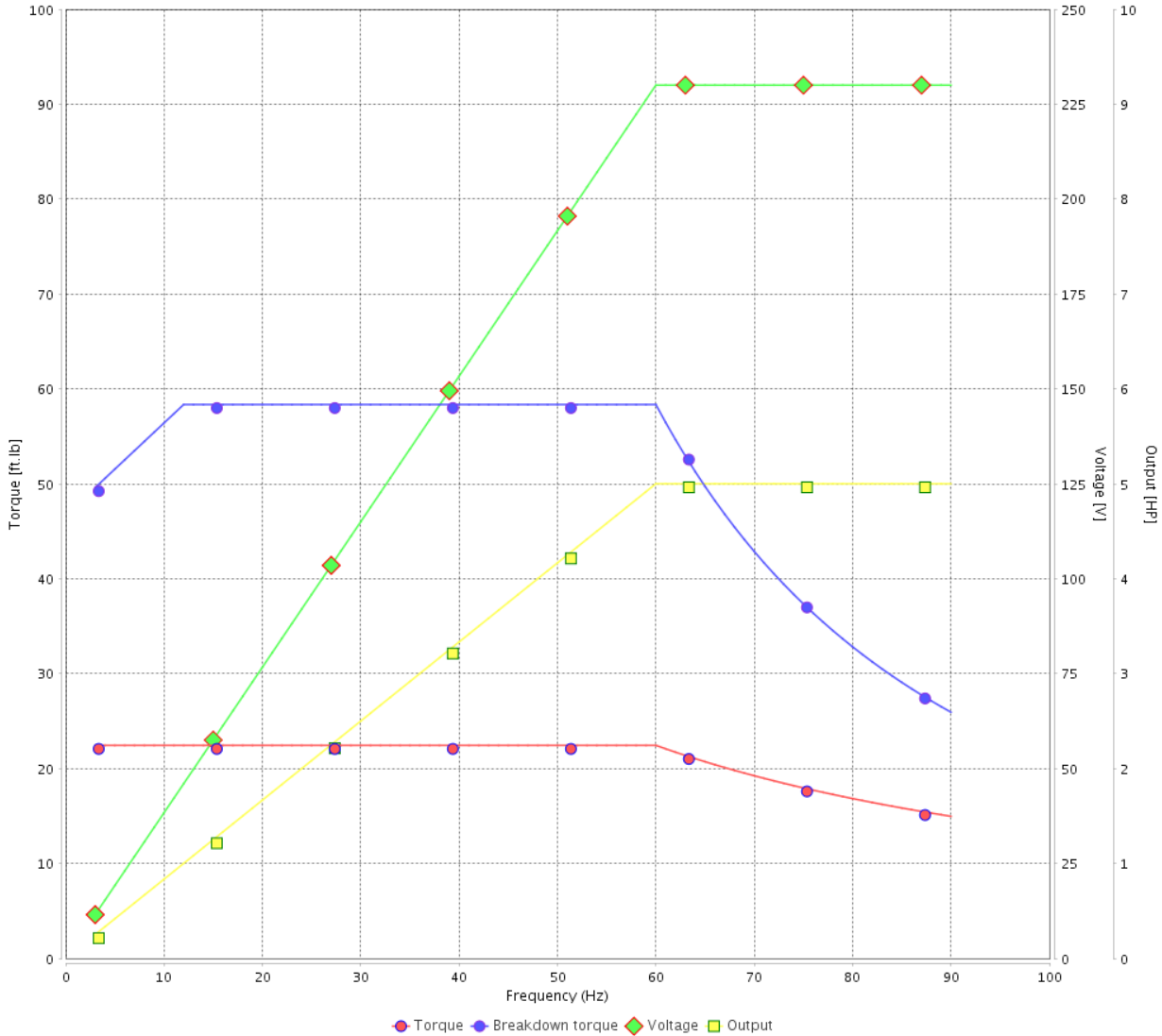

Performance : 230/460 V 60 Hz 6P

Rated current : 13.7/6.83 A
 LRC : 6.8
 Rated torque : 22.4 ft.lb
 Locked rotor torque : 170 %
 Breakdown torque : 260 %
 Rated speed : 1170 rpm

Moment of inertia (J) : 1.47 sq.ft.lb
 Duty cycle : Cont.(S1)
 Insulation class : F
 Service factor : 1.25
 Temperature rise : 80 K
 Design : B

Rev.	Changes Summary	Performed	Checked	Date
Performed by			Page 18 / 21	Revision
Checked by				
Date	12/04/2022			

VFD OPERATION CURVE

Three Phase Induction Motor - Squirrel Cage



Customer : _____

Product line : NEMA Premium Efficiency Three-Phase Product code : 11606439
 Catalog # : 00512ET3E215TC-W22

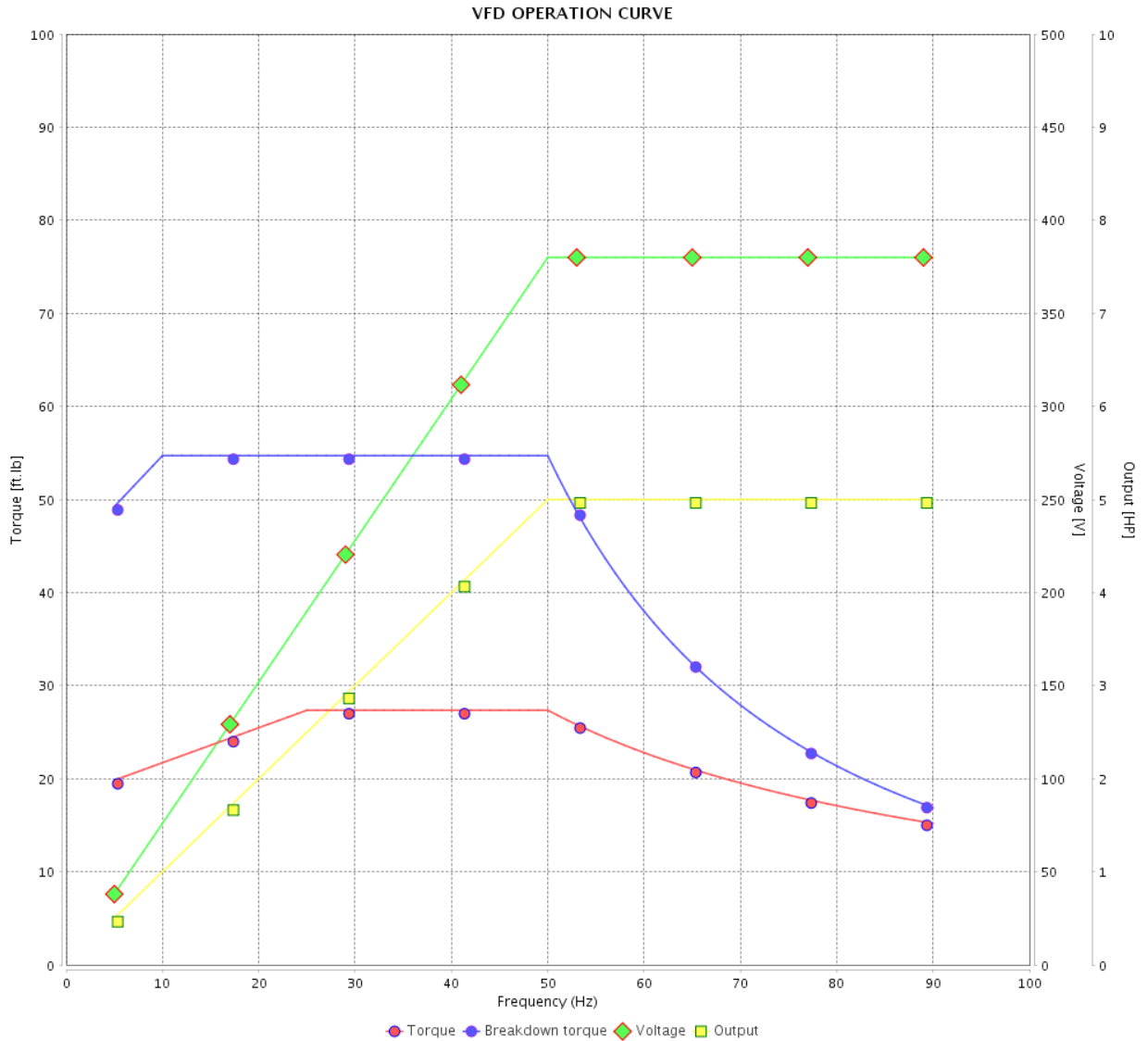

Performance : 380 V 50 Hz 6P IE3

Rated current : 8.10 A	Moment of inertia (J) : 1.47 sq.ft.lb
LRC : 5.5	Duty cycle : Cont.(S1)
Rated torque : 27.4 ft.lb	Insulation class : F
Locked rotor torque : 140 %	Service factor : 1.00
Breakdown torque : 200 %	Temperature rise : 80 K
Rated speed : 960 rpm	Design : B

Rev.	Changes Summary	Performed	Checked	Date
Performed by				Page 19 / 21
Checked by				
Date	12/04/2022			
				Revision

VFD OPERATION CURVE

Three Phase Induction Motor - Squirrel Cage



Customer :

Product line : NEMA Premium Efficiency Three-Phase

Product code : 11606439

Catalog # : 00512ET3E215TC-W22

VFD OPERATION CURVE

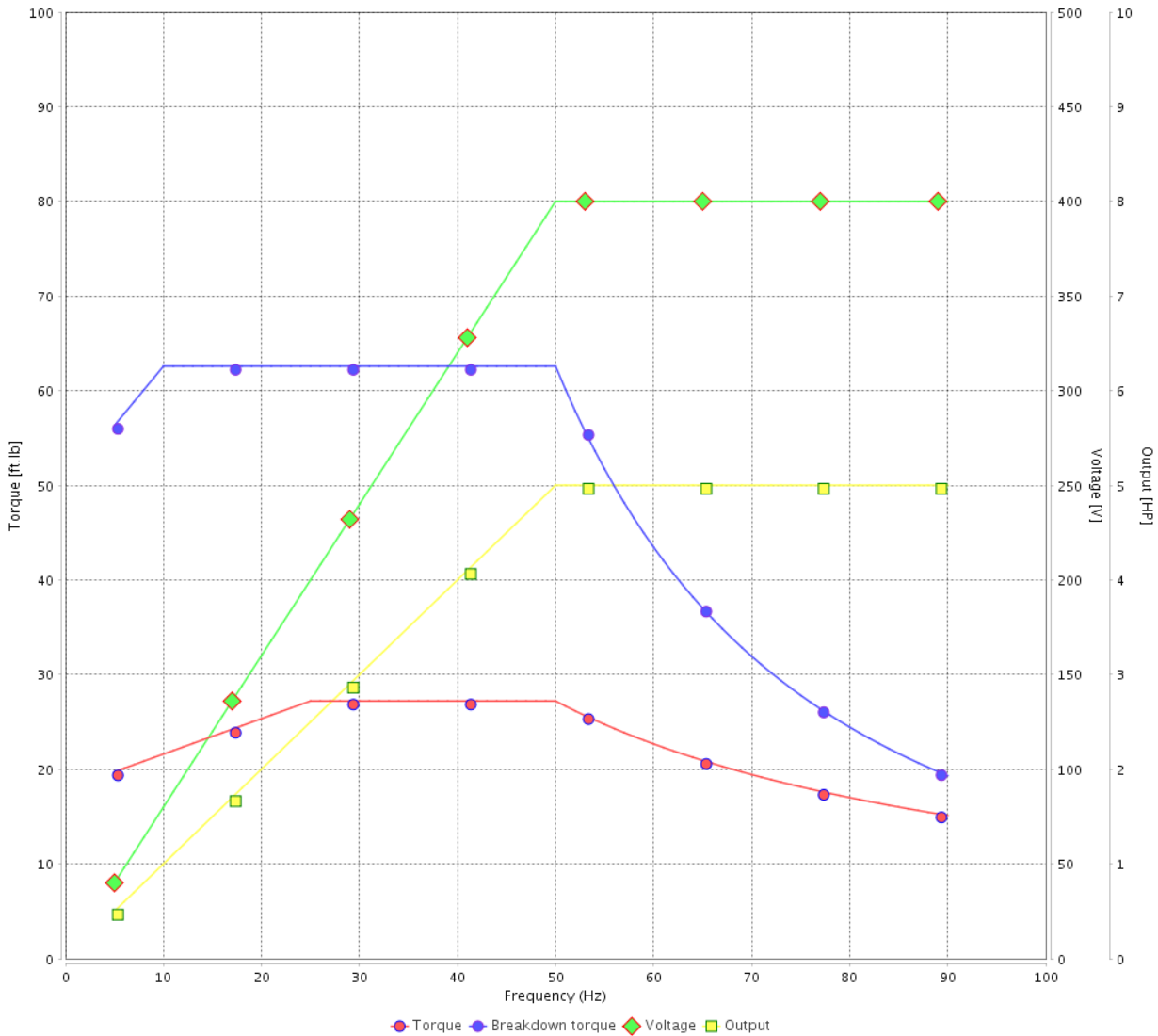

Performance : 400 V 50 Hz 6P IE3

Rated current	: 7.82 A	Moment of inertia (J)	: 1.47 sq.ft.lb
LRC	: 6.1	Duty cycle	: Cont.(S1)
Rated torque	: 27.2 ft.lb	Insulation class	: F
Locked rotor torque	: 160 %	Service factor	: 1.00
Breakdown torque	: 229 %	Temperature rise	: 80 K
Rated speed	: 965 rpm	Design	: B

Rev.	Changes Summary	Performed	Checked	Date
Performed by			Page 20 / 21	Revision
Checked by				
Date	12/04/2022			

VFD OPERATION CURVE

Three Phase Induction Motor - Squirrel Cage



Customer :

Product line : NEMA Premium Efficiency Three-Phase

Product code : 11606439

Catalog # : 00512ET3E215TC-W22

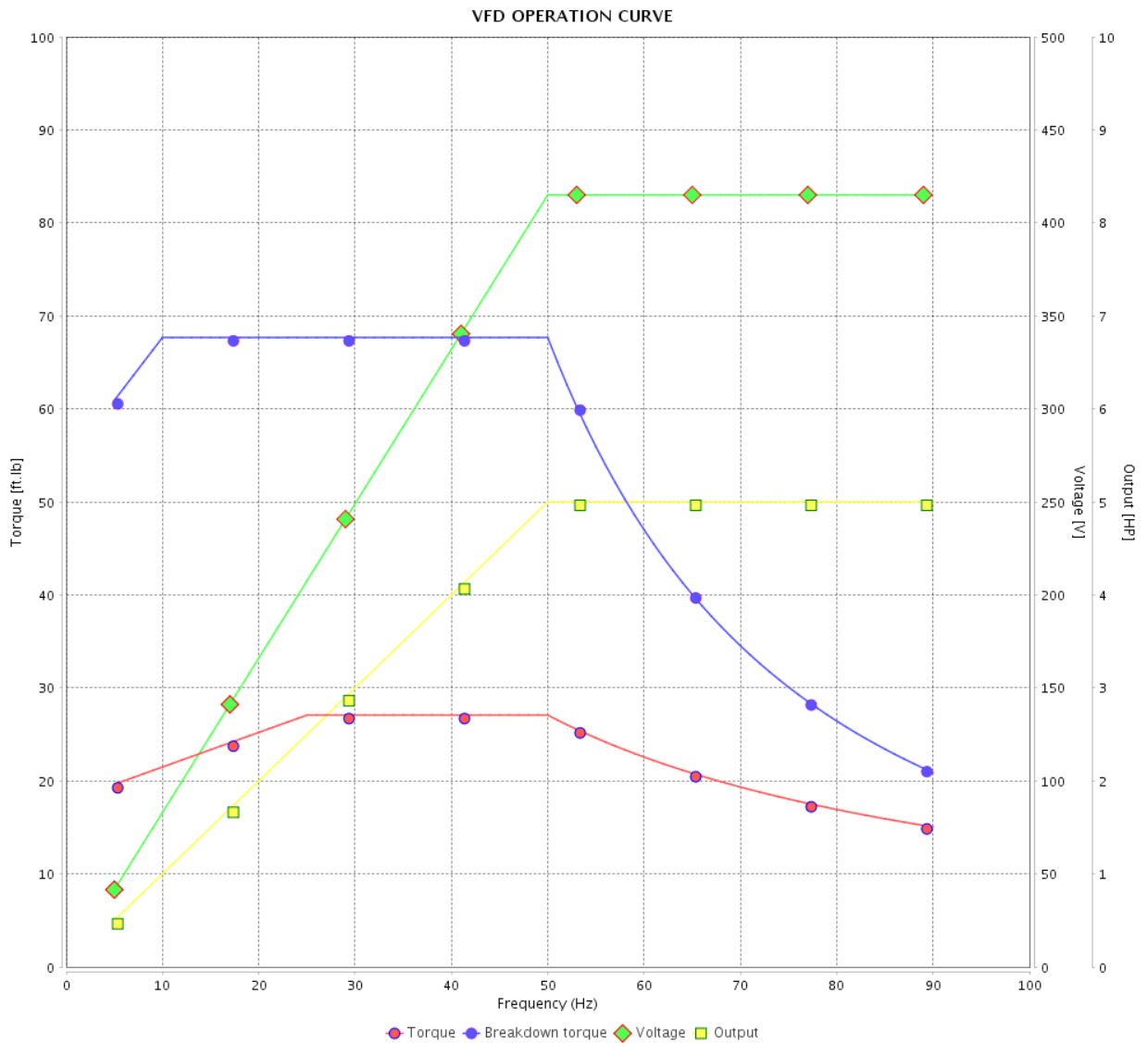

Performance : 415 V 50 Hz 6P IE3

Rated current : 7.55 A
 LRC : 6.5
 Rated torque : 27.1 ft.lb
 Locked rotor torque : 190 %
 Breakdown torque : 250 %
 Rated speed : 970 rpm

Moment of inertia (J) : 1.47 sq.ft.lb
 Duty cycle : Cont.(S1)
 Insulation class : F
 Service factor : 1.00
 Temperature rise : 80 K
 Design : B

Rev.	Changes Summary	Performed	Checked	Date
Performed by				Page 21 / 21
Checked by				
Date	12/04/2022			

1 2 3 4 5 6

A

B

C

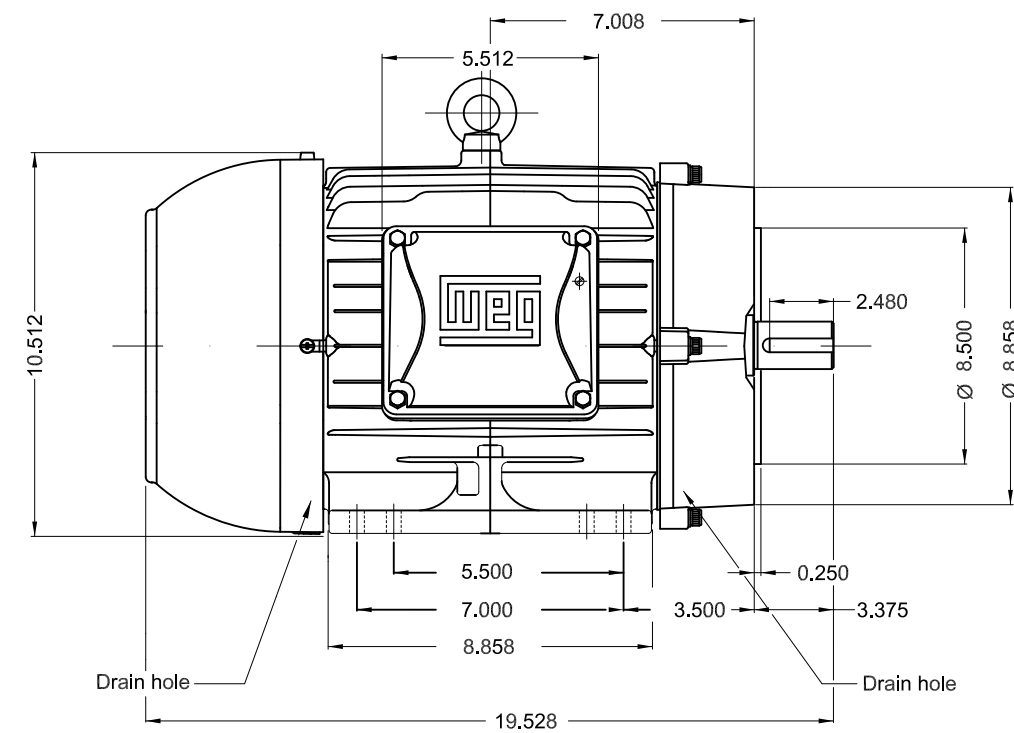
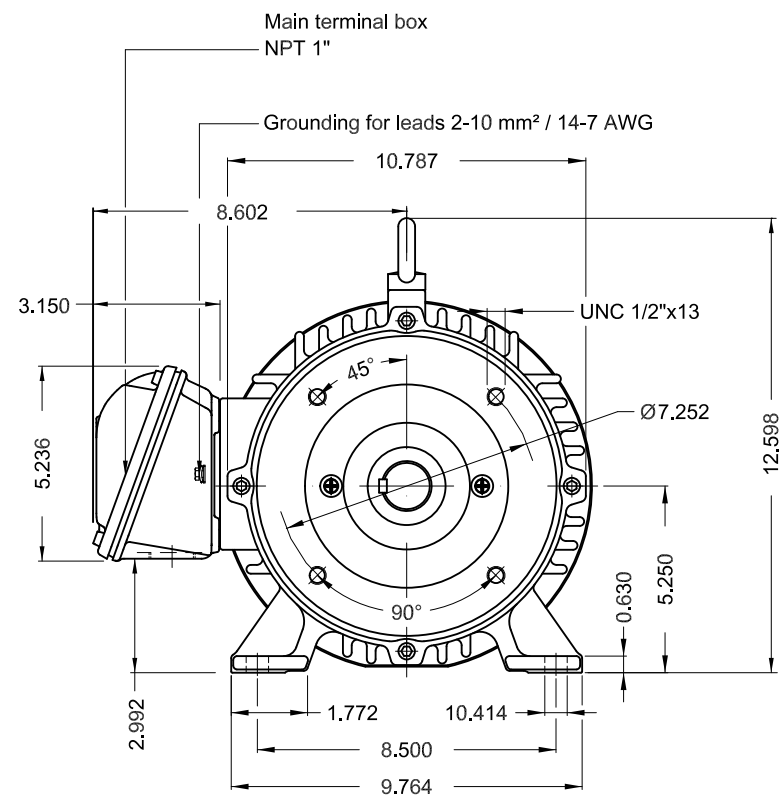

D

E

Bearing cap
Color RAL 5009
Painting plan 207A
Mounting B34R(D)

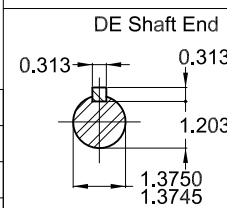

5 HP 06 Poles 60 Hz

A

ECM	LOC	SUMMARY OF MODIFICATIONS	EXECUTED	CHECKED	RELEASED	DATE	VER
EXECUTED	PIRWBUSER	THREE PH. MOTOR W22 PREM. EFF.					
CHECKED		FRAME 213/5TC IP55 TEFC					
RELEASED							
REL DT.	WMO	Jaragua do Sul	Product Engineering	SHEET	1 / 1		

PREVIEW
WDD



MADE IN BRAZIL
11606439



W22

MODEL 00512ET3E215TC-W22

Inverter Duty Motor
Severe Duty



For use on 60Hz
Class I, Div 2, Gr A, B, C and D - T3
Class I, Zone 2, IIC - T3
Class II, Div 2, Gr F and G - T4
For use on PWM: Gr. A, B, C, D and F,
VT 1000:1, CT 20:1, 1.00SF - T3A



FOR SAFE AREA
Mod. TE1BFOXON
CC029A

PH3 60Hz Fr. 213/5TC 1000m.a.s.l. IP55 TEFC 177lb

V 230/460

A 13.7/6.83

HP 5.0

kW 3.7

SF 1.25

SFA 17.1/8.54

RPM 1170

PF 0.76

AMB 40°C

INS cl. F DT80K

NEMA NOM EFF 89.5%

DUTY CONT.

DES B Code J

USABLE @208V 15.1A SF 1.15 SFA 17.4

5.0HP 3.7kW 50Hz 380V 8.10A 960RPM SF 1.00 EFF 86.8% (IE3)

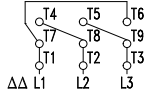

208-230V

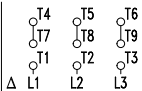

380//460V



MOBIL POLYREX EM

