

DATA SHEET



Three Phase Induction Motor - Squirrel Cage

Customer :							
Product line	: NEMA Premium Efficiency Three-Phase	Product code :	11431312				
		Catalog # :	00536ST3QIE184T-W22				
Frame	: 182/4T	Cooling method	: IC411 - TEFC				
Insulation class	: F	Mounting	: F-1				
Duty cycle	: Cont.(S1)	Rotation ¹	: Both (CW and CCW)				
Ambient temperature	: -20°C to +40°C	Starting method	: Direct On Line				
Altitude	: 1000 m.a.s.l.	Approx. weight ²	: 110 lb				
Protection degree	: IP55	Moment of inertia (J)	: 0.2233 sq.ft.lb				
Design	: B						
Output [HP]	5	4	4	4	5	5	5
Poles	2	2	2	2	2	2	2
Frequency [Hz]	60	50	50	50	50	50	50
Rated voltage [V]	460	380	400	415	380	400	415
Rated current [A]	5.90	5.79	5.57	5.43	7.14	6.78	6.61
L. R. Amperes [A]	44.8	42.8	45.1	48.3	42.1	44.7	47.6
LRC [A]	7.6x(Code J)	7.4x(Code H)	8.1x(Code J)	8.9x(Code K)	5.9x(Code F)	6.6x(Code G)	7.2x(Code H)
No load current [A]	2.00	2.00	2.15	2.25	2.00	2.15	2.25
Rated speed [RPM]	3485	2890	2900	2910	2850	2870	2880
Slip [%]	3.19	3.67	3.33	3.00	5.00	4.33	4.00
Rated torque [ft.lb]	7.53	7.27	7.24	7.22	9.21	9.15	9.12
Locked rotor torque [%]	229	229	270	300	180	210	240
Breakdown torque [%]	350	320	370	400	250	290	320
Service factor	1.25	1.25	1.25	1.25	1.25	1.25	1.25
Temperature rise	80 K	80 K	80 K	80 K	80 K	80 K	80 K
Locked rotor time	45s (cold) 25s (hot)	32s (cold) 18s (hot)	32s (cold) 18s (hot)	32s (cold) 18s (hot)	32s (cold) 18s (hot)	32s (cold) 18s (hot)	32s (cold) 18s (hot)
Noise level ²	66.0 dB(A)	62.0 dB(A)	62.0 dB(A)	62.0 dB(A)	62.0 dB(A)	62.0 dB(A)	62.0 dB(A)
Efficiency (%)	25%						
	50%	86.5	86.3	86.3	86.1	87.5	87.5
	75%	88.5	87.7	88.2	88.2	87.5	88.5
	100%	88.5	87.5	88.3	88.3	86.5	87.5
Power Factor	25%						
	50%	0.76	0.74	0.71	0.68	0.81	0.78
	75%	0.85	0.85	0.83	0.81	0.88	0.87
	100%	0.89	0.90	0.88	0.87	0.91	0.90
Bearing type	: Drive end : 6207 C3	Non drive end : 6206 C3	Foundation loads				
Sealing	: Inpro/Seal	Inpro/Seal	Max. traction	: 131 lb			
Lubrication interval	: 20000 h	20000 h	Max. compression	: 241 lb			
Lubricant amount	: 7 g	5 g					
Lubricant type	: Mobil Polyrex EM						
Notes							
This revision replaces and cancel the previous one, which must be eliminated. (1) Looking the motor from the shaft end. (2) Measured at 1m and with tolerance of +3dB(A). (3) Approximate weight subject to changes after manufacturing process. (4) At 100% of full load.				These are average values based on tests with sinusoidal power supply, subject to the tolerances stipulated in NEMA MG-1.			
Rev.	Changes Summary			Performed	Checked	Date	
Performed by							
Checked by					Page	Revision	
Date	13/04/2022				1 / 36		

TORQUE AND CURRENT VS SPEED CURVE

Three Phase Induction Motor - Squirrel Cage



Customer :

Product line : NEMA Premium Efficiency Three-Phase

Product code : 11431312

Catalog # : 00536ST3QIE184T-W22

TORQUE AND CURRENT VS SPEED CURVE

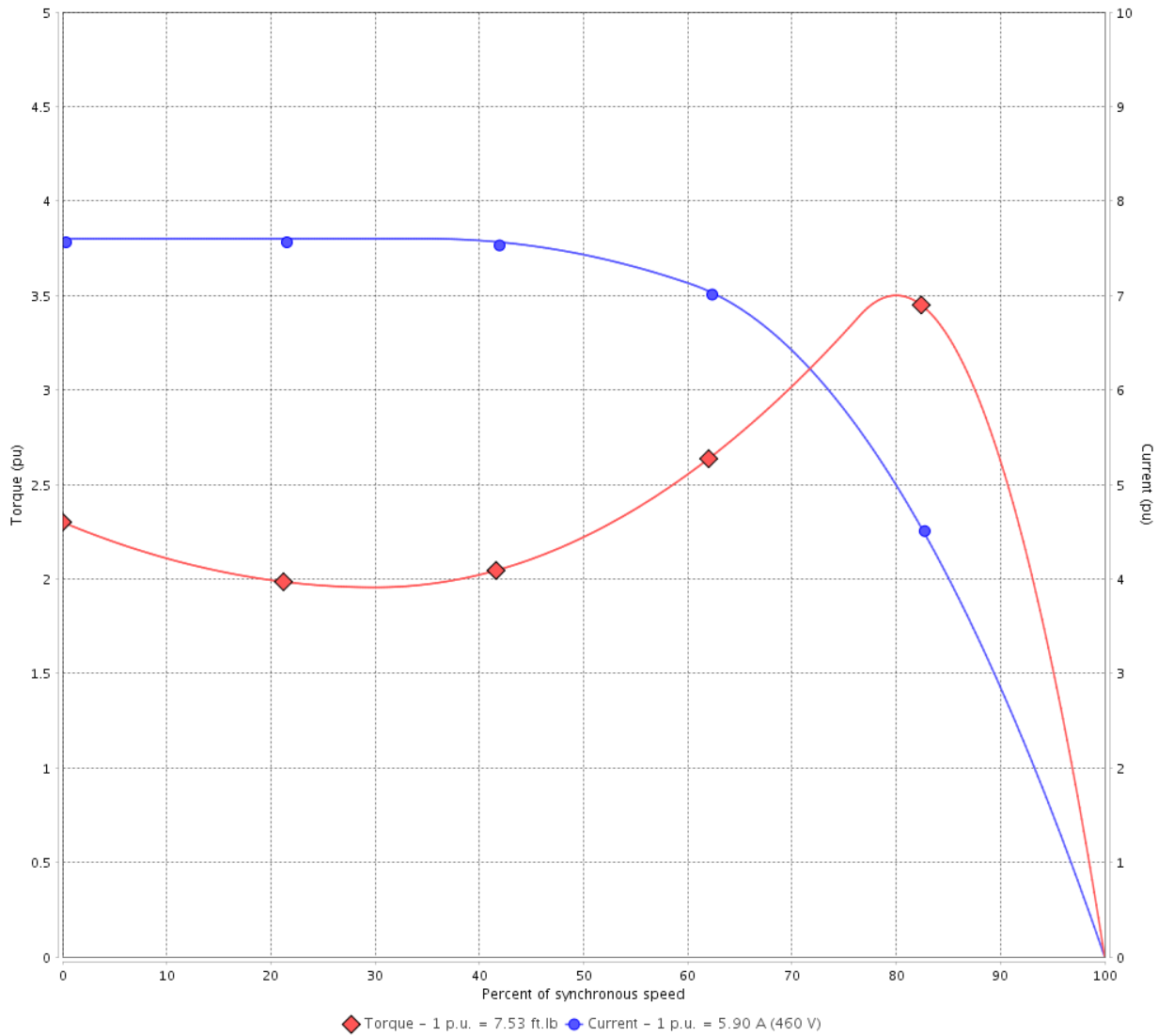

Performance : 460 V 60 Hz 2P

Rated current	: 5.90 A	Moment of inertia (J)	: 0.2233 sq.ft.lb
LRC	: 7.6	Duty cycle	: Cont.(S1)
Rated torque	: 7.53 ft.lb	Insulation class	: F
Locked rotor torque	: 229 %	Service factor	: 1.25
Breakdown torque	: 350 %	Temperature rise	: 80 K
Rated speed	: 3485 rpm	Design	: B

Locked rotor time : 45s (cold) 25s (hot)

Rev.	Changes Summary	Performed	Checked	Date
Performed by			Page 2 / 36	Revision
Checked by				
Date	13/04/2022			

TORQUE AND CURRENT VS SPEED CURVE



Three Phase Induction Motor - Squirrel Cage

Customer :

Product line : NEMA Premium Efficiency Three-Phase

Product code : 11431312

Catalog # : 00536ST3QIE184T-W22

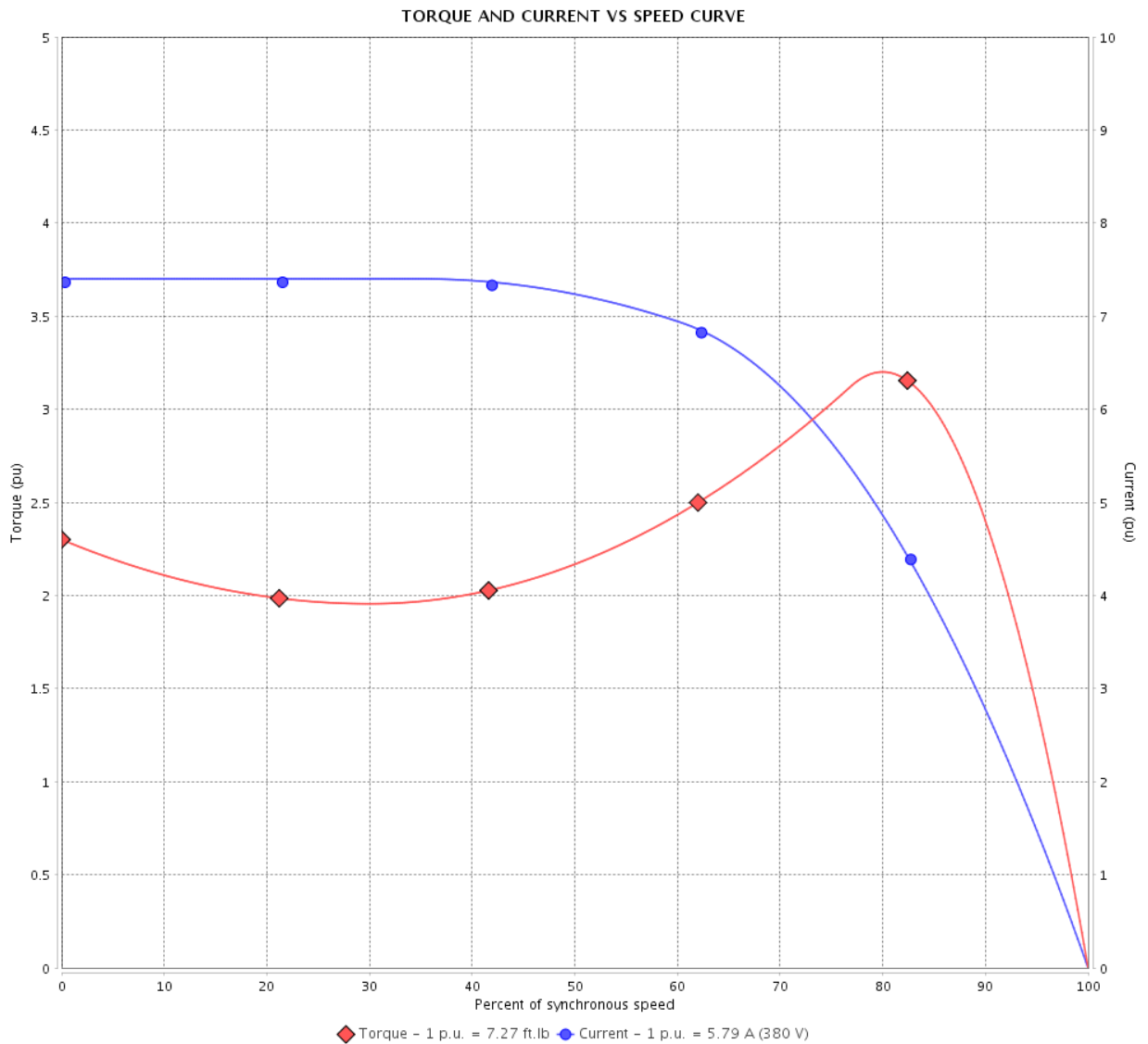

Performance : 380 V 50 Hz 2P IE3

Rated current	: 5.79 A	Moment of inertia (J)	: 0.2233 sq.ft.lb
LRC	: 7.4	Duty cycle	: Cont.(S1)
Rated torque	: 7.27 ft.lb	Insulation class	: F
Locked rotor torque	: 229 %	Service factor	: 1.25
Breakdown torque	: 320 %	Temperature rise	: 80 K
Rated speed	: 2890 rpm	Design	: B

Locked rotor time : 32s (cold) 18s (hot)

Rev.	Changes Summary	Performed	Checked	Date
Performed by			Page 3 / 36	Revision
Checked by				
Date	13/04/2022			

TORQUE AND CURRENT VS SPEED CURVE

Three Phase Induction Motor - Squirrel Cage



Customer :

Product line : NEMA Premium Efficiency Three-Phase

Product code : 11431312

Catalog # : 00536ST3QIE184T-W22

TORQUE AND CURRENT VS SPEED CURVE

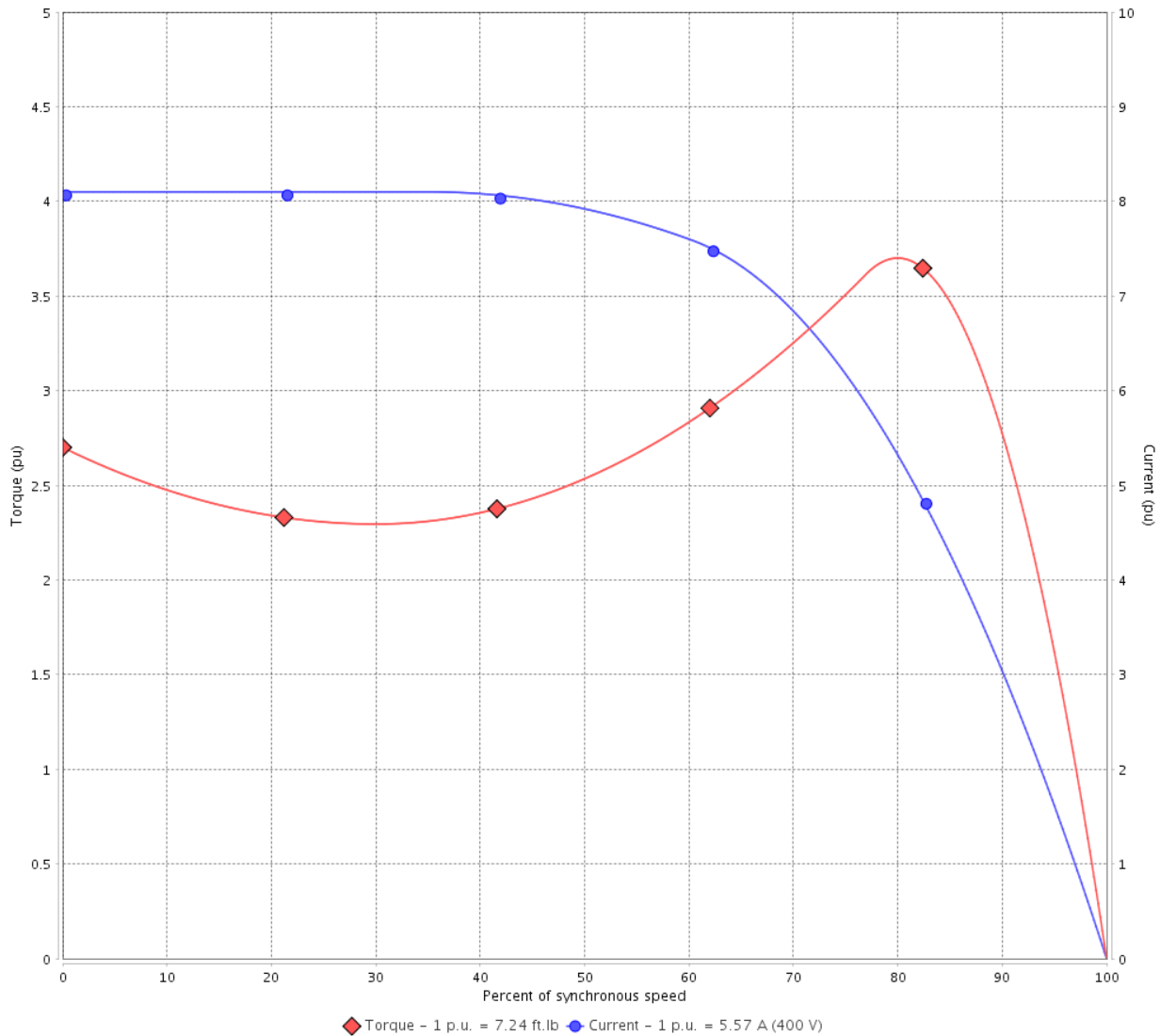

Performance : 400 V 50 Hz 2P IE3

Rated current	: 5.57 A	Moment of inertia (J)	: 0.2233 sq.ft.lb
LRC	: 8.1	Duty cycle	: Cont.(S1)
Rated torque	: 7.24 ft.lb	Insulation class	: F
Locked rotor torque	: 270 %	Service factor	: 1.25
Breakdown torque	: 370 %	Temperature rise	: 80 K
Rated speed	: 2900 rpm	Design	: B

Locked rotor time : 32s (cold) 18s (hot)

Rev.	Changes Summary	Performed	Checked	Date
Performed by			Page 4 / 36	Revision
Checked by				
Date	13/04/2022			

TORQUE AND CURRENT VS SPEED CURVE



Three Phase Induction Motor - Squirrel Cage

Customer :

Product line : NEMA Premium Efficiency Three-Phase

Product code : 11431312

Catalog # : 00536ST3QIE184T-W22

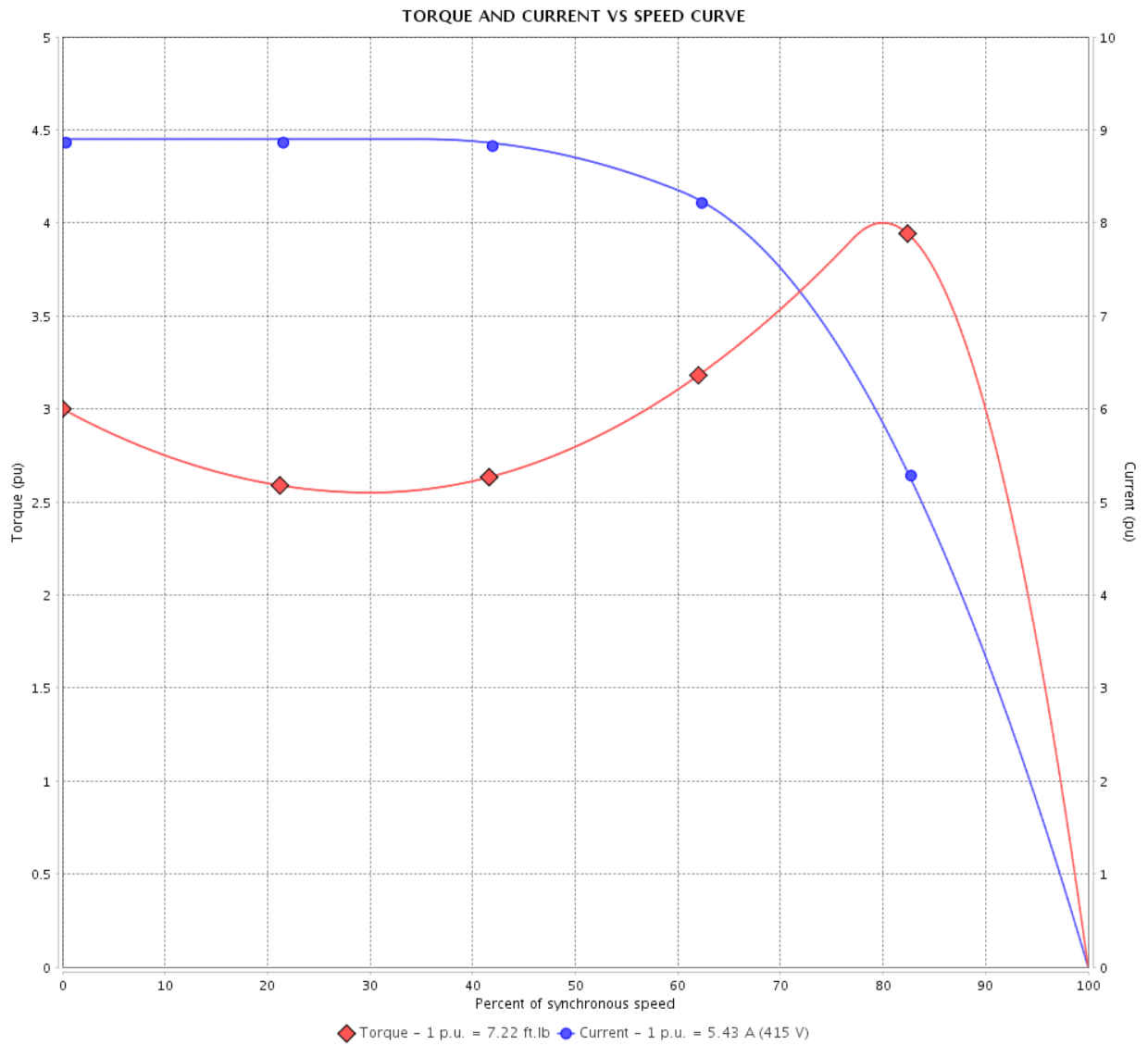

Performance : 415 V 50 Hz 2P IE3

Rated current : 5.43 A
 LRC : 8.9
 Rated torque : 7.22 ft.lb
 Locked rotor torque : 300 %
 Breakdown torque : 400 %
 Rated speed : 2910 rpm

Moment of inertia (J) : 0.2233 sq.ft.lb
 Duty cycle : Cont.(S1)
 Insulation class : F
 Service factor : 1.25
 Temperature rise : 80 K
 Design : B

Locked rotor time : 32s (cold) 18s (hot)

Rev.	Changes Summary	Performed	Checked	Date
Performed by			Page 5 / 36	Revision
Checked by				
Date	13/04/2022			

TORQUE AND CURRENT VS SPEED CURVE

Three Phase Induction Motor - Squirrel Cage



Customer :

Product line : NEMA Premium Efficiency Three-Phase

Product code : 11431312

Catalog # : 00536ST3QIE184T-W22

TORQUE AND CURRENT VS SPEED CURVE

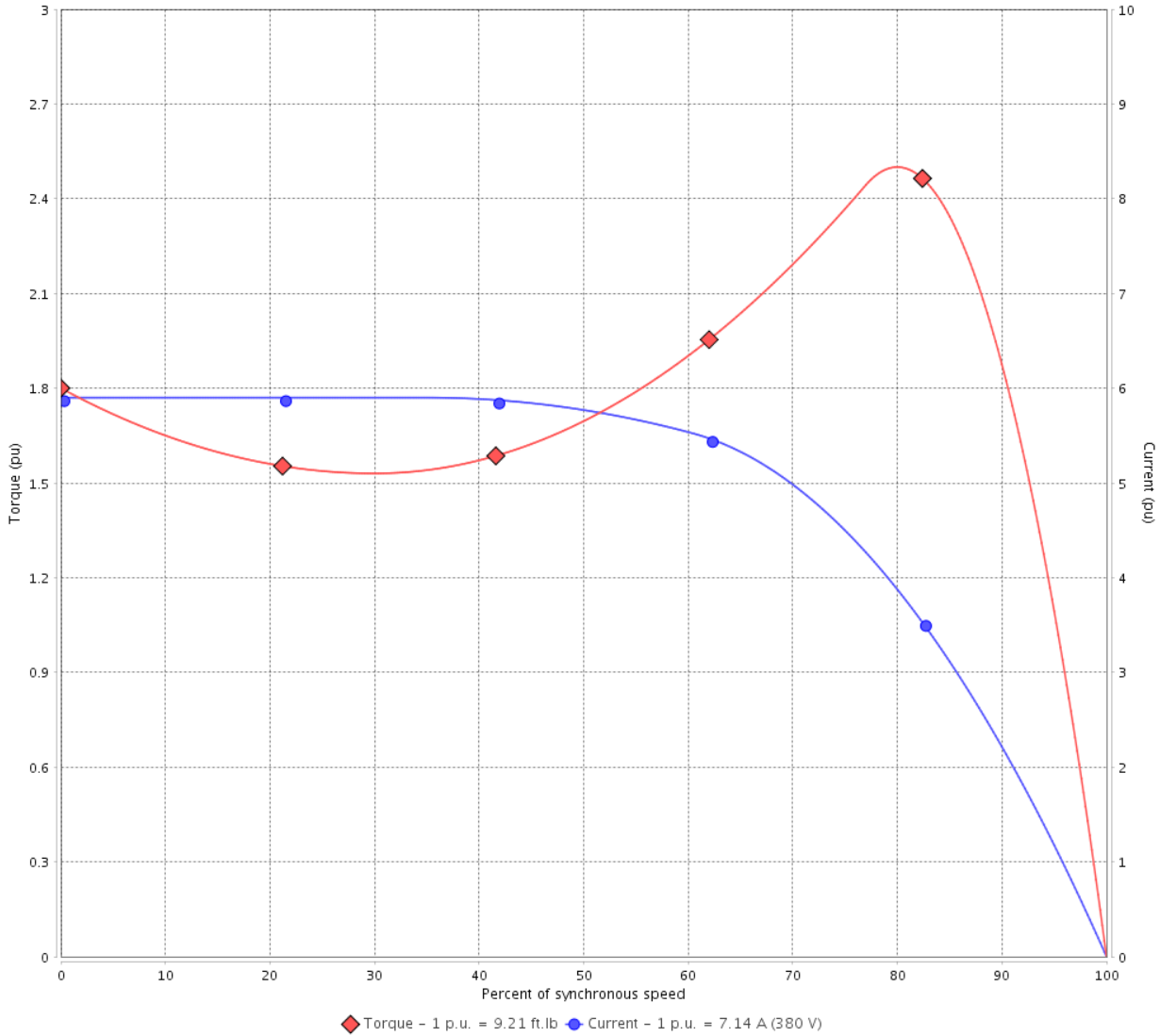

Performance : 380 V 50 Hz 2P IE2

Rated current	: 7.14 A	Moment of inertia (J)	: 0.2233 sq.ft.lb
LRC	: 5.9	Duty cycle	: Cont.(S1)
Rated torque	: 9.21 ft.lb	Insulation class	: F
Locked rotor torque	: 180 %	Service factor	: 1.25
Breakdown torque	: 250 %	Temperature rise	: 80 K
Rated speed	: 2850 rpm	Design	: B

Locked rotor time : 32s (cold) 18s (hot)

Rev.	Changes Summary	Performed	Checked	Date
Performed by			Page 6 / 36	Revision
Checked by				
Date	13/04/2022			

TORQUE AND CURRENT VS SPEED CURVE



Three Phase Induction Motor - Squirrel Cage

Customer :

Product line : NEMA Premium Efficiency Three-Phase

Product code : 11431312

Catalog # : 00536ST3QIE184T-W22

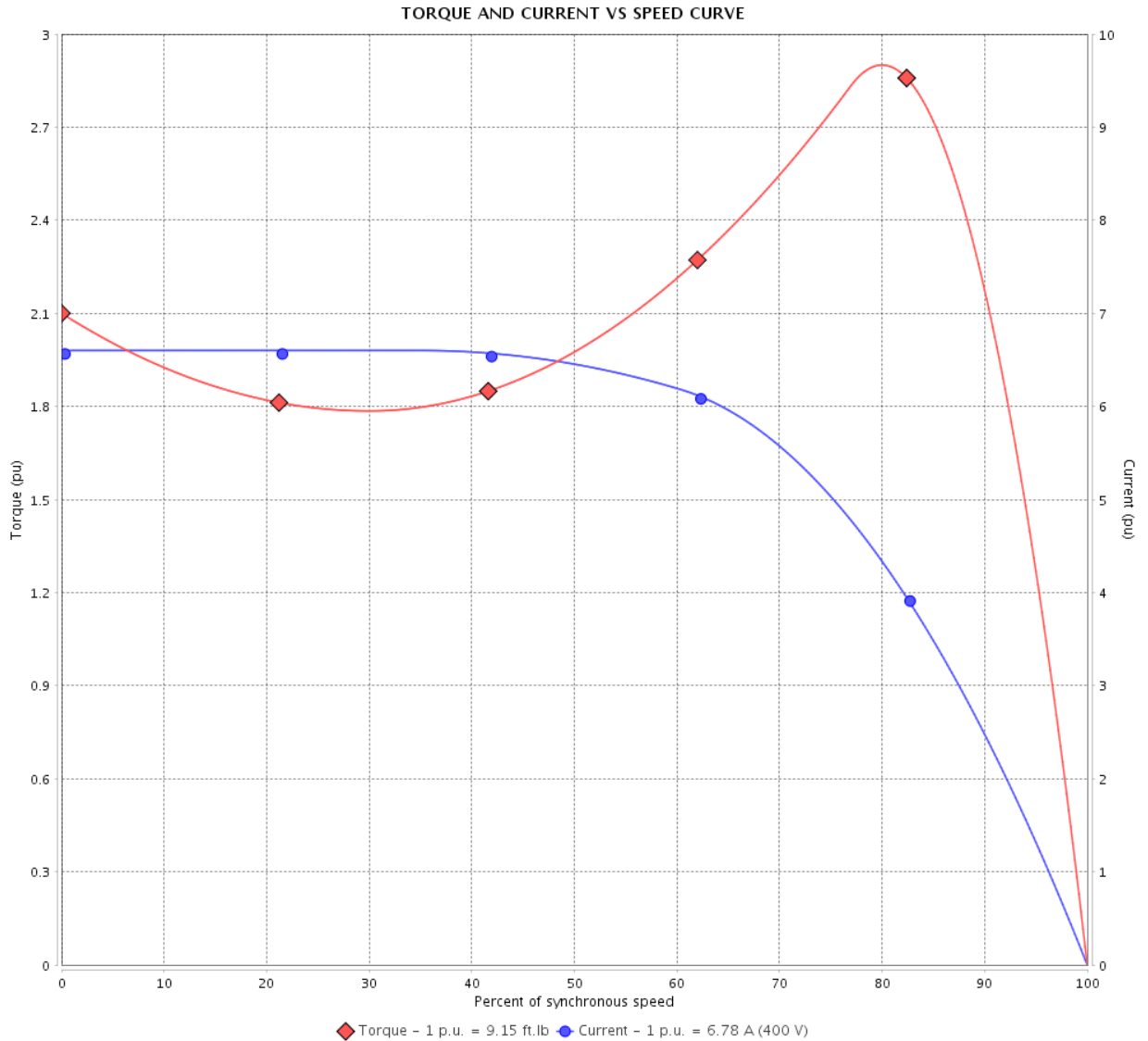

Performance : 400 V 50 Hz 2P IE2

Rated current : 6.78 A
 LRC : 6.6
 Rated torque : 9.15 ft.lb
 Locked rotor torque : 210 %
 Breakdown torque : 290 %
 Rated speed : 2870 rpm

Moment of inertia (J) : 0.2233 sq.ft.lb
 Duty cycle : Cont.(S1)
 Insulation class : F
 Service factor : 1.25
 Temperature rise : 80 K
 Design : B

Locked rotor time : 32s (cold) 18s (hot)

Rev.	Changes Summary	Performed	Checked	Date
Performed by			Page 7 / 36	Revision
Checked by				
Date	13/04/2022			

TORQUE AND CURRENT VS SPEED CURVE

Three Phase Induction Motor - Squirrel Cage



Customer :

Product line : NEMA Premium Efficiency Three-Phase

Product code : 11431312

Catalog # : 00536ST3QIE184T-W22

TORQUE AND CURRENT VS SPEED CURVE

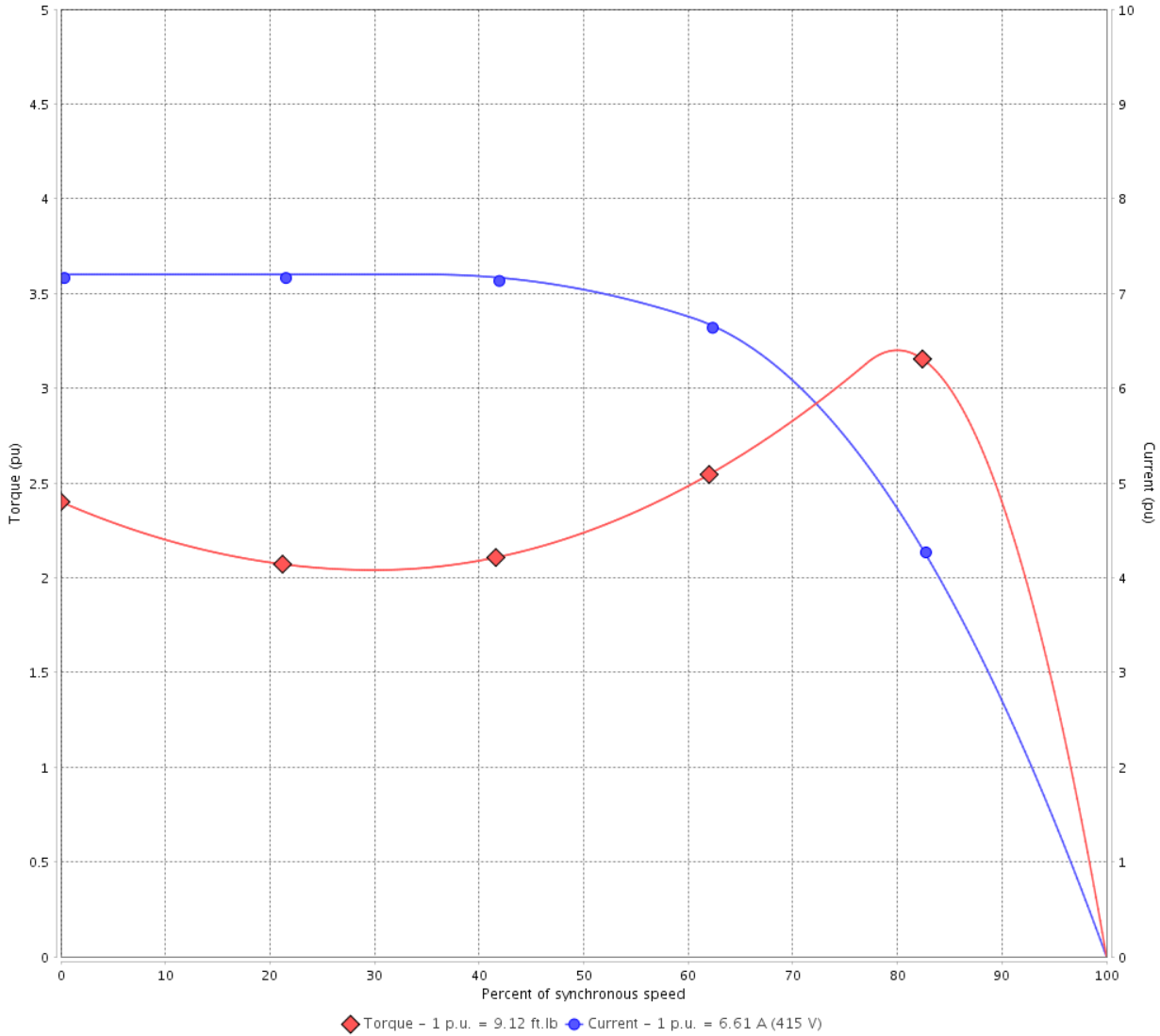

Performance : 415 V 50 Hz 2P IE2

Rated current	: 6.61 A	Moment of inertia (J)	: 0.2233 sq.ft.lb
LRC	: 7.2	Duty cycle	: Cont.(S1)
Rated torque	: 9.12 ft.lb	Insulation class	: F
Locked rotor torque	: 240 %	Service factor	: 1.25
Breakdown torque	: 320 %	Temperature rise	: 80 K
Rated speed	: 2880 rpm	Design	: B

Locked rotor time : 32s (cold) 18s (hot)

Rev.	Changes Summary	Performed	Checked	Date
Performed by			Page 8 / 36	Revision
Checked by				
Date	13/04/2022			

LOAD PERFORMANCE CURVE

Three Phase Induction Motor - Squirrel Cage



Customer :

Product line : NEMA Premium Efficiency Three-Phase

Product code : 11431312

Catalog # : 00536ST3QIE184T-W22

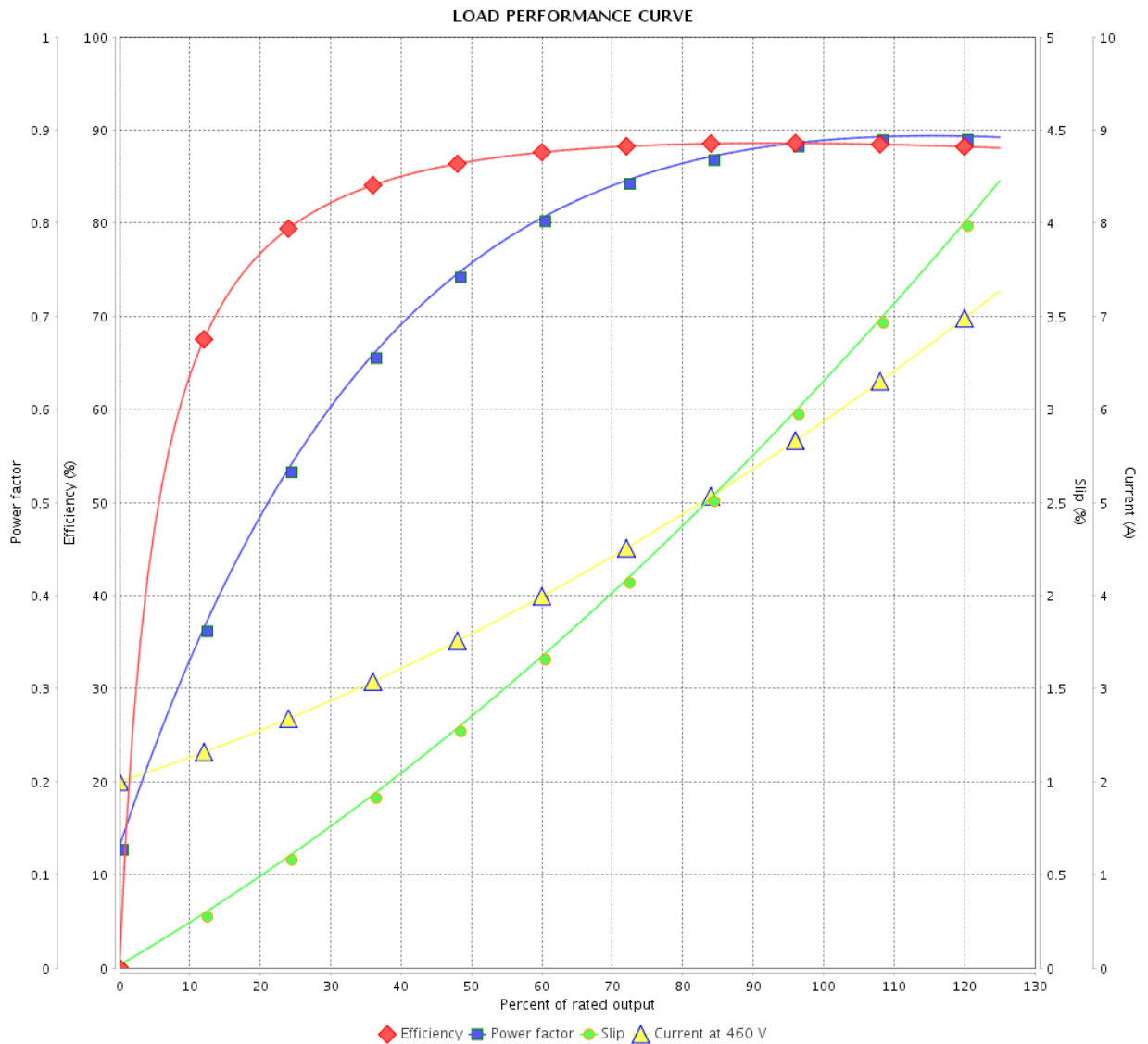

Performance : 460 V 60 Hz 2P

Rated current : 5.90 A
 LRC : 7.6
 Rated torque : 7.53 ft.lb
 Locked rotor torque : 229 %
 Breakdown torque : 350 %
 Rated speed : 3485 rpm

Moment of inertia (J) : 0.2233 sq.ft.lb
 Duty cycle : Cont.(S1)
 Insulation class : F
 Service factor : 1.25
 Temperature rise : 80 K
 Design : B

Rev.	Changes Summary	Performed	Checked	Date
Performed by			Page	Revision
Checked by			9 / 36	
Date	13/04/2022			

LOAD PERFORMANCE CURVE

Three Phase Induction Motor - Squirrel Cage



Customer :

Product line : NEMA Premium Efficiency Three-Phase

Product code : 11431312

Catalog # : 00536ST3QIE184T-W22

LOAD PERFORMANCE CURVE

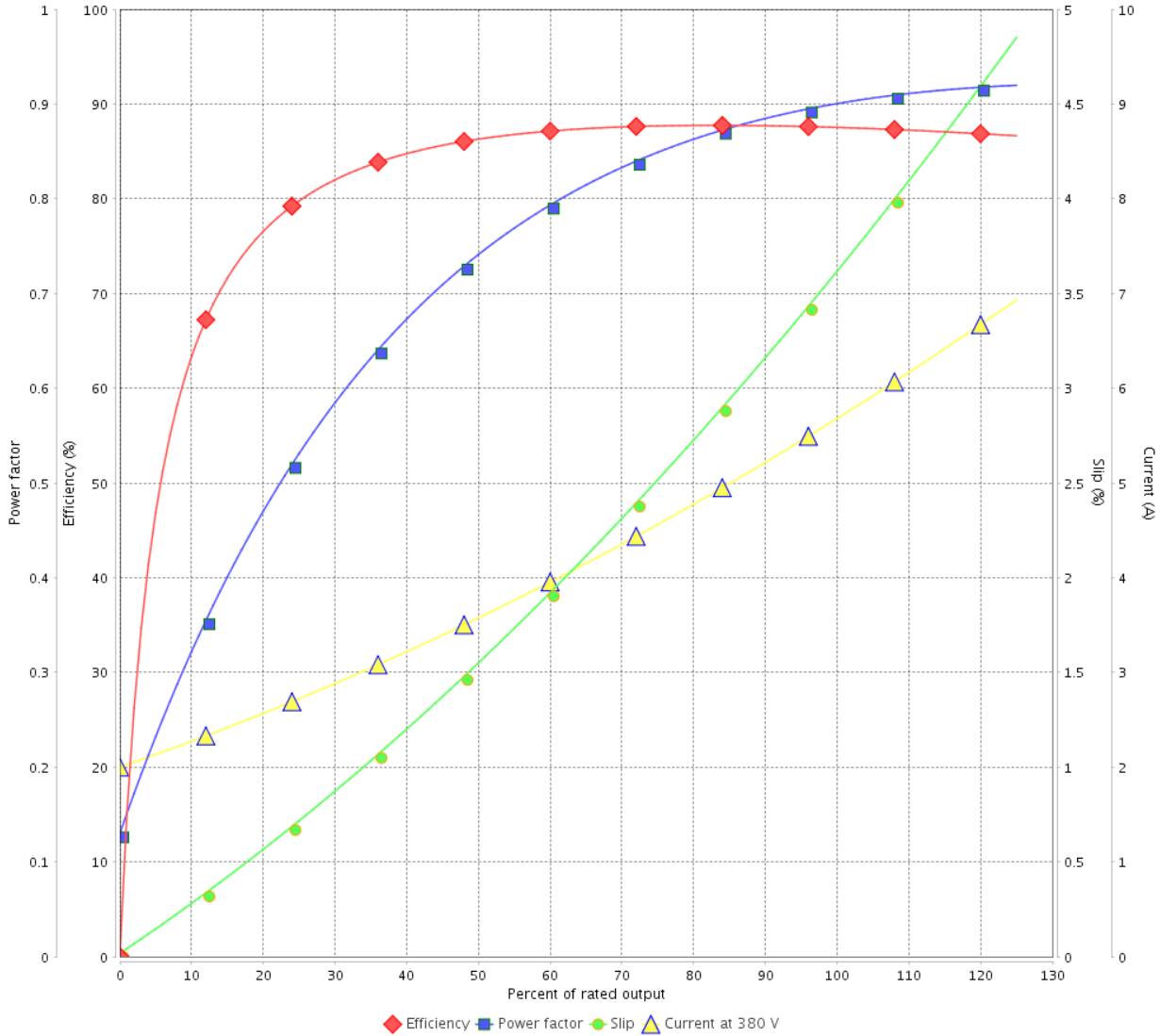

Performance : 380 V 50 Hz 2P IE3

Rated current : 5.79 A
 LRC : 7.4
 Rated torque : 7.27 ft.lb
 Locked rotor torque : 229 %
 Breakdown torque : 320 %
 Rated speed : 2890 rpm

Moment of inertia (J) : 0.2233 sq.ft.lb
 Duty cycle : Cont.(S1)
 Insulation class : F
 Service factor : 1.25
 Temperature rise : 80 K
 Design : B

Rev.	Changes Summary	Performed	Checked	Date
Performed by		Page		Revision
Checked by		10 / 36		
Date	13/04/2022			

LOAD PERFORMANCE CURVE

Three Phase Induction Motor - Squirrel Cage



Customer : _____

Product line : NEMA Premium Efficiency Three-Phase

Product code : 11431312

Catalog # : 00536ST3QIE184T-W22

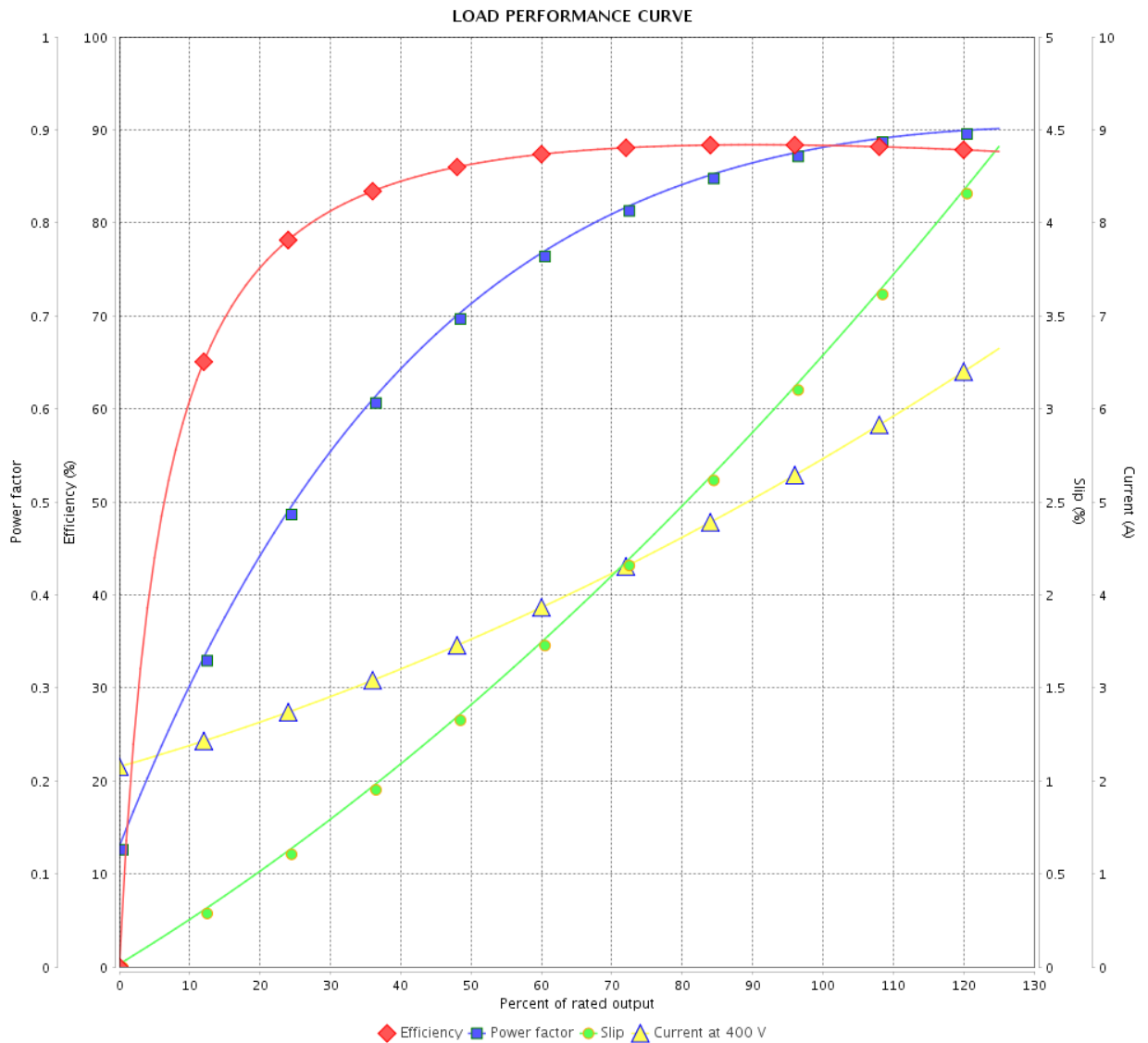

Performance : 400 V 50 Hz 2P IE3

Rated current : 5.57 A
 LRC : 8.1
 Rated torque : 7.24 ft.lb
 Locked rotor torque : 270 %
 Breakdown torque : 370 %
 Rated speed : 2900 rpm

Moment of inertia (J) : 0.2233 sq.ft.lb
 Duty cycle : Cont.(S1)
 Insulation class : F
 Service factor : 1.25
 Temperature rise : 80 K
 Design : B

Rev.	Changes Summary	Performed	Checked	Date
Performed by		Page		Revision
Checked by		11 / 36		
Date		13/04/2022		

LOAD PERFORMANCE CURVE

Three Phase Induction Motor - Squirrel Cage



Customer :

Product line : NEMA Premium Efficiency Three-Phase

Product code : 11431312

Catalog # : 00536ST3QIE184T-W22

LOAD PERFORMANCE CURVE

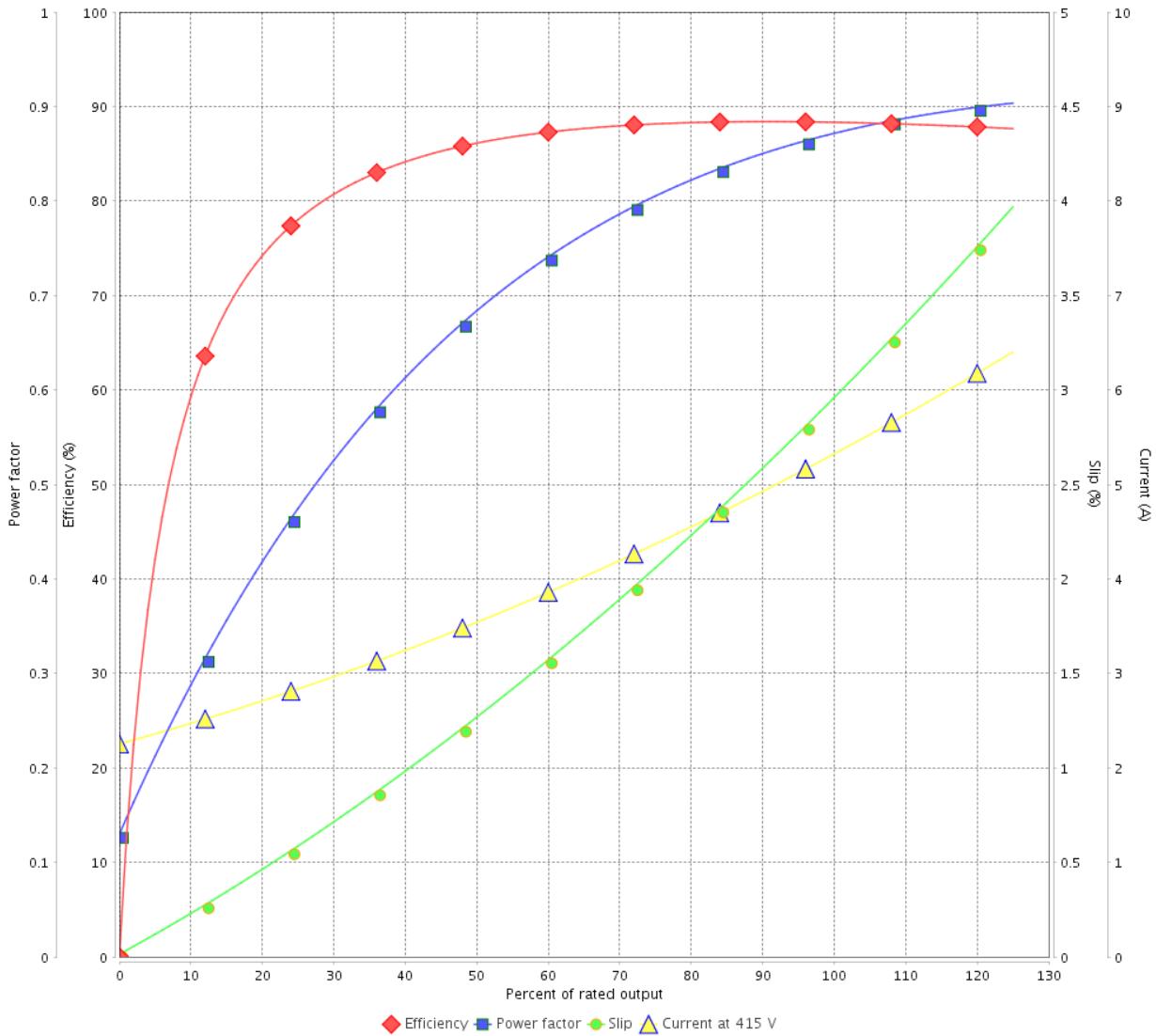

Performance : 415 V 50 Hz 2P IE3

Rated current : 5.43 A
 LRC : 8.9
 Rated torque : 7.22 ft.lb
 Locked rotor torque : 300 %
 Breakdown torque : 400 %
 Rated speed : 2910 rpm

Moment of inertia (J) : 0.2233 sq.ft.lb
 Duty cycle : Cont.(S1)
 Insulation class : F
 Service factor : 1.25
 Temperature rise : 80 K
 Design : B

Rev.	Changes Summary	Performed	Checked	Date
Performed by			Page	Revision
Checked by			12 / 36	
Date	13/04/2022			

LOAD PERFORMANCE CURVE

Three Phase Induction Motor - Squirrel Cage



Customer : _____

Product line : NEMA Premium Efficiency Three-Phase

Product code : 11431312

Catalog # : 00536ST3QIE184T-W22

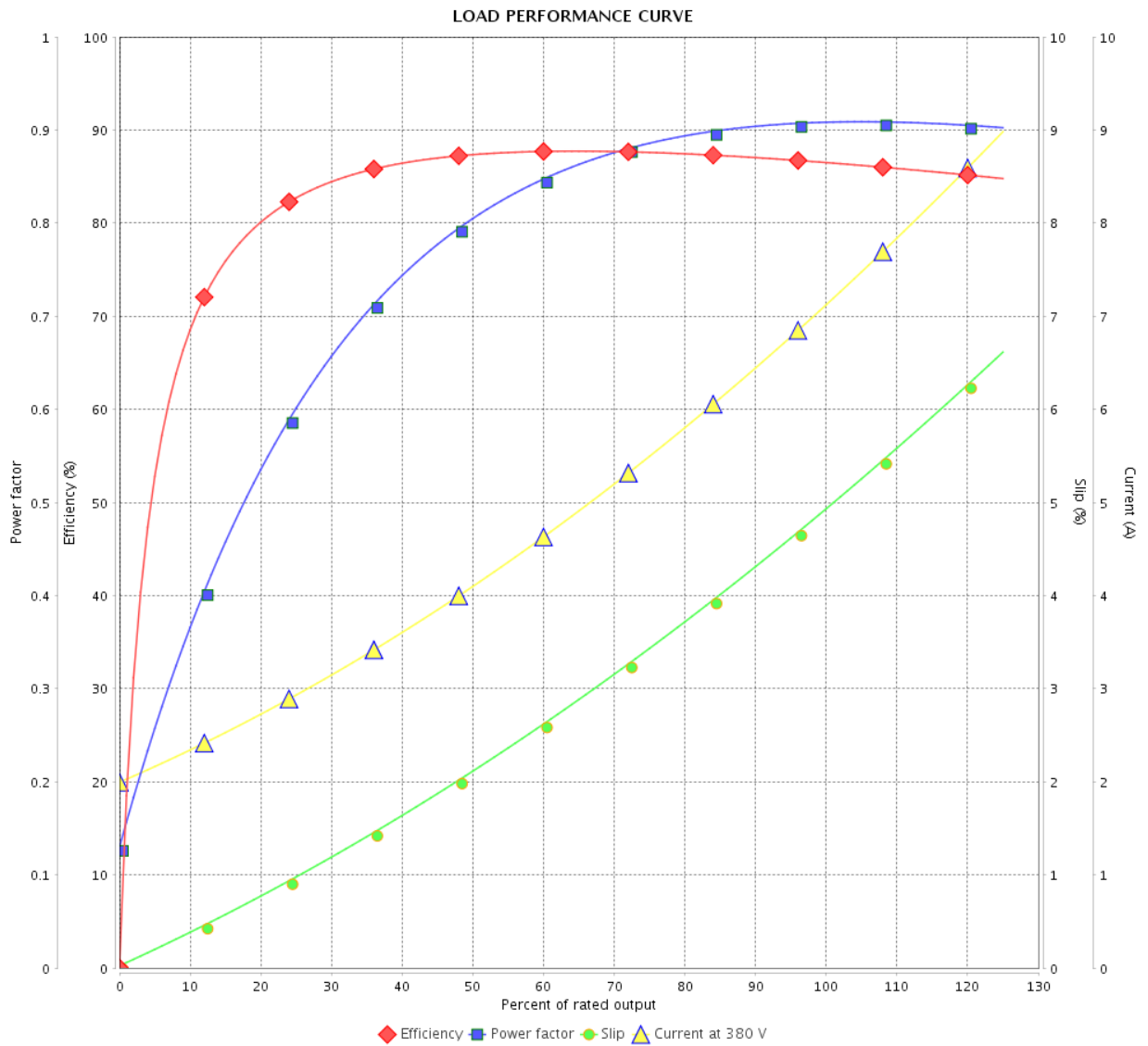

Performance : 380 V 50 Hz 2P IE2

Rated current : 7.14 A
 LRC : 5.9
 Rated torque : 9.21 ft.lb
 Locked rotor torque : 180 %
 Breakdown torque : 250 %
 Rated speed : 2850 rpm

Moment of inertia (J) : 0.2233 sq.ft.lb
 Duty cycle : Cont.(S1)
 Insulation class : F
 Service factor : 1.25
 Temperature rise : 80 K
 Design : B

Rev.	Changes Summary	Performed	Checked	Date
Performed by			Page	Revision
Checked by			13 / 36	
Date	13/04/2022			

LOAD PERFORMANCE CURVE

Three Phase Induction Motor - Squirrel Cage



Customer :

Product line : NEMA Premium Efficiency Three-Phase

Product code : 11431312

Catalog # : 00536ST3QIE184T-W22

LOAD PERFORMANCE CURVE

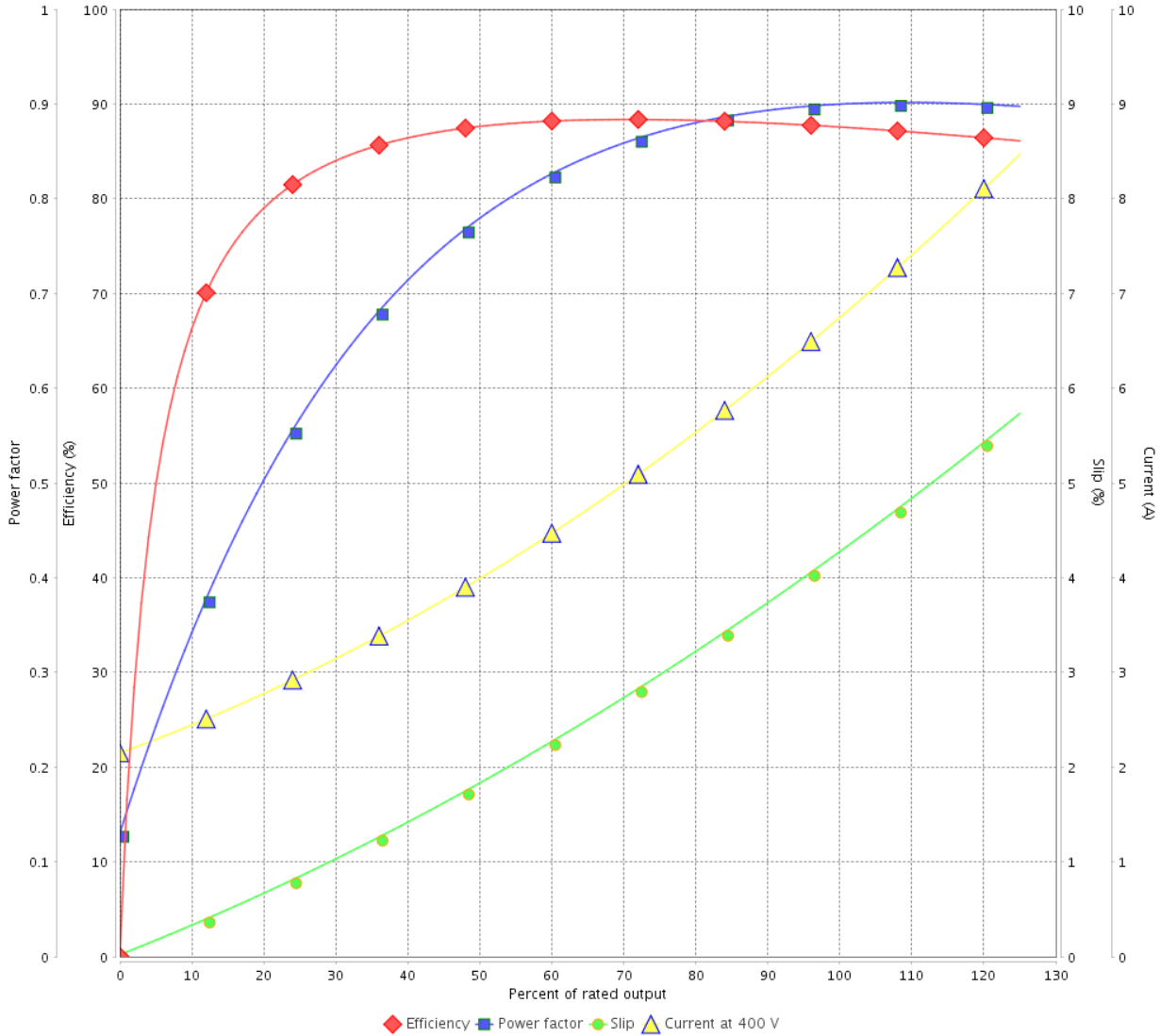

Performance : 400 V 50 Hz 2P IE2

Rated current : 6.78 A
 LRC : 6.6
 Rated torque : 9.15 ft.lb
 Locked rotor torque : 210 %
 Breakdown torque : 290 %
 Rated speed : 2870 rpm

Moment of inertia (J) : 0.2233 sq.ft.lb
 Duty cycle : Cont.(S1)
 Insulation class : F
 Service factor : 1.25
 Temperature rise : 80 K
 Design : B

Rev.	Changes Summary	Performed	Checked	Date
Performed by			Page 14 / 36	Revision
Checked by				
Date	13/04/2022			

LOAD PERFORMANCE CURVE

Three Phase Induction Motor - Squirrel Cage



Customer : _____

Product line : NEMA Premium Efficiency Three-Phase

Product code : 11431312

Catalog # : 00536ST3QIE184T-W22

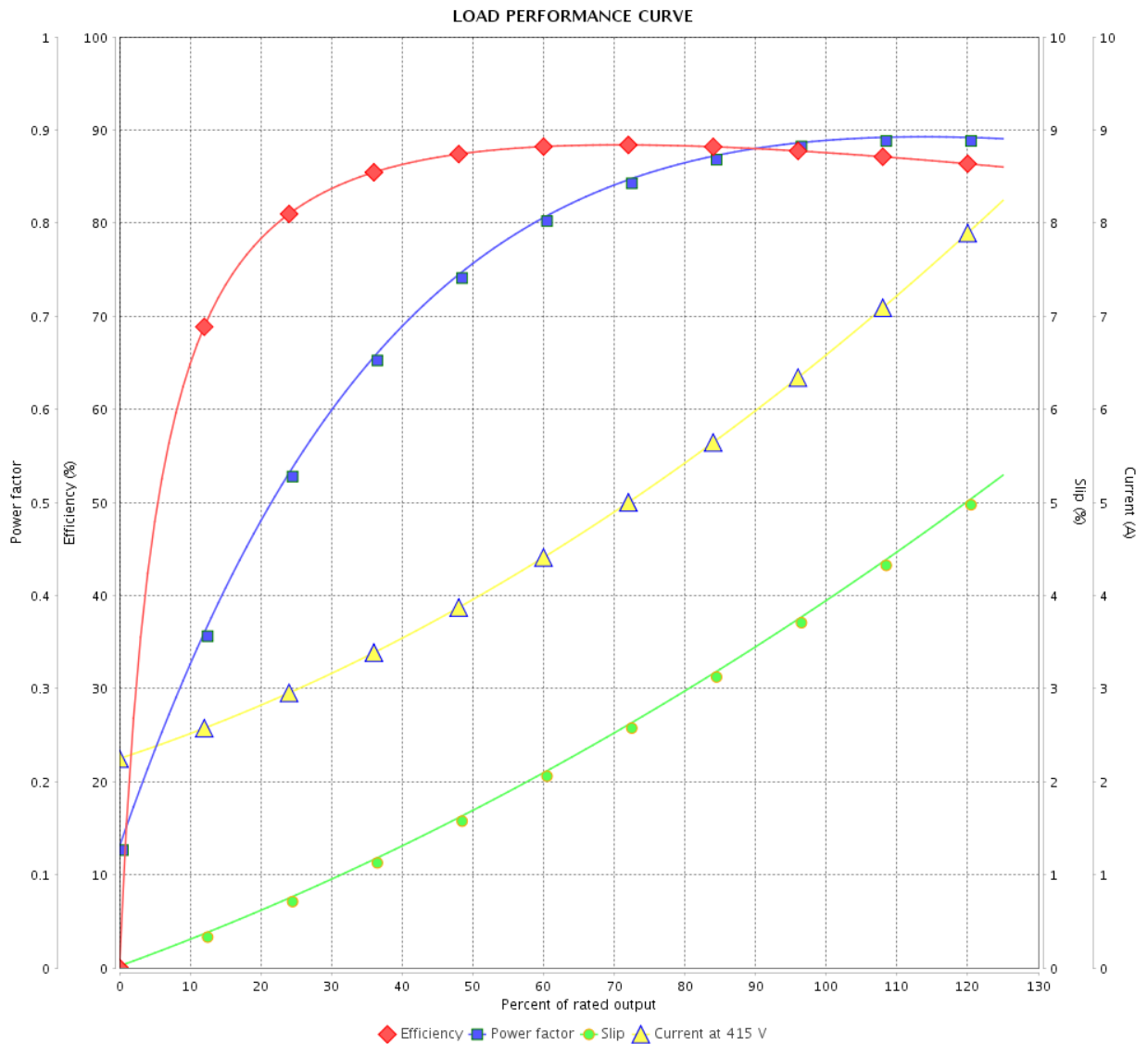

Performance : 415 V 50 Hz 2P IE2

Rated current : 6.61 A
 LRC : 7.2
 Rated torque : 9.12 ft.lb
 Locked rotor torque : 240 %
 Breakdown torque : 320 %
 Rated speed : 2880 rpm

Moment of inertia (J) : 0.2233 sq.ft.lb
 Duty cycle : Cont.(S1)
 Insulation class : F
 Service factor : 1.25
 Temperature rise : 80 K
 Design : B

Rev.	Changes Summary	Performed	Checked	Date
Performed by			Page	Revision
Checked by				
Date				
			15 / 36	

THERMAL LIMIT CURVE

Three Phase Induction Motor - Squirrel Cage



Customer :

Product line : NEMA Premium Efficiency Three-Phase

Product code : 11431312

Catalog # : 00536ST3QIE184T-W22

Performance : 460 V 60 Hz 2P

Rated current : 5.90 A
LRC : 7.6
Rated torque : 7.53 ft.lb
Locked rotor torque : 229 %
Breakdown torque : 350 %
Rated speed : 3485 rpm

Moment of inertia (J) : 0.2233 sq.ft.lb
Duty cycle : Cont.(S1)
Insulation class : F
Service factor : 1.25
Temperature rise : 80 K
Design : B

Heating constant

Cooling constant

Rev.	Changes Summary	Performed	Checked	Date
Performed by				
Checked by			Page	Revision
Date	13/04/2022		16 / 36	

THERMAL LIMIT CURVE

Three Phase Induction Motor - Squirrel Cage



Customer : _____

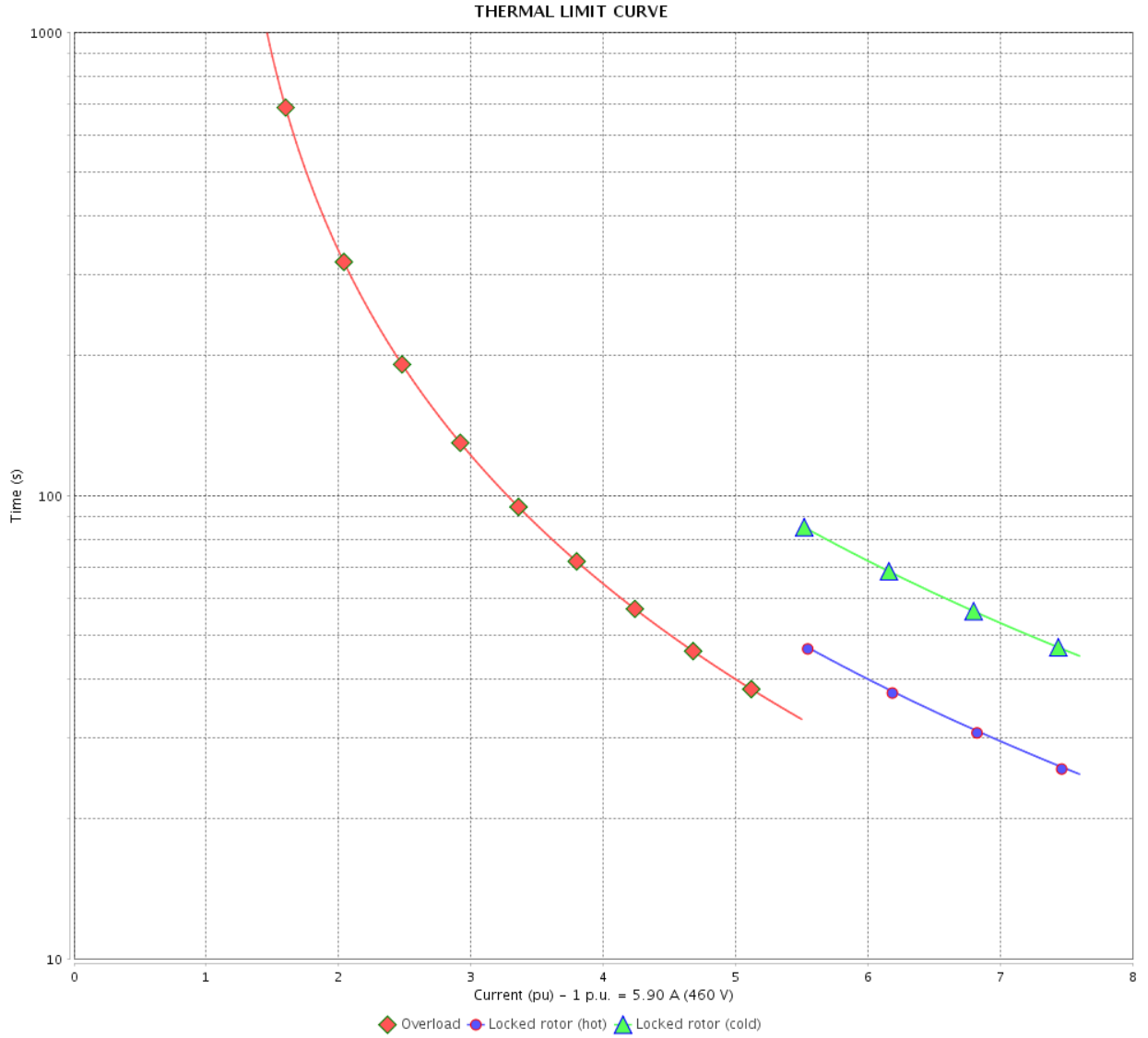

Rev.	Changes Summary	Performed	Checked	Date
Performed by		Page 17 / 36		Revision
Checked by				
Date				

THERMAL LIMIT CURVE

Three Phase Induction Motor - Squirrel Cage



Customer :

Product line : NEMA Premium Efficiency Three-Phase

Product code : 11431312

Catalog # : 00536ST3QIE184T-W22

Performance : 380 V 50 Hz 2P IE3

Rated current : 5.79 A
LRC : 7.4
Rated torque : 7.27 ft.lb
Locked rotor torque : 229 %
Breakdown torque : 320 %
Rated speed : 2890 rpm

Moment of inertia (J) : 0.2233 sq.ft.lb
Duty cycle : Cont.(S1)
Insulation class : F
Service factor : 1.25
Temperature rise : 80 K
Design : B

Heating constant

Cooling constant

Rev.	Changes Summary	Performed	Checked	Date
Performed by				
Checked by			Page	Revision
Date	13/04/2022		18 / 36	

THERMAL LIMIT CURVE

Three Phase Induction Motor - Squirrel Cage



Customer : _____

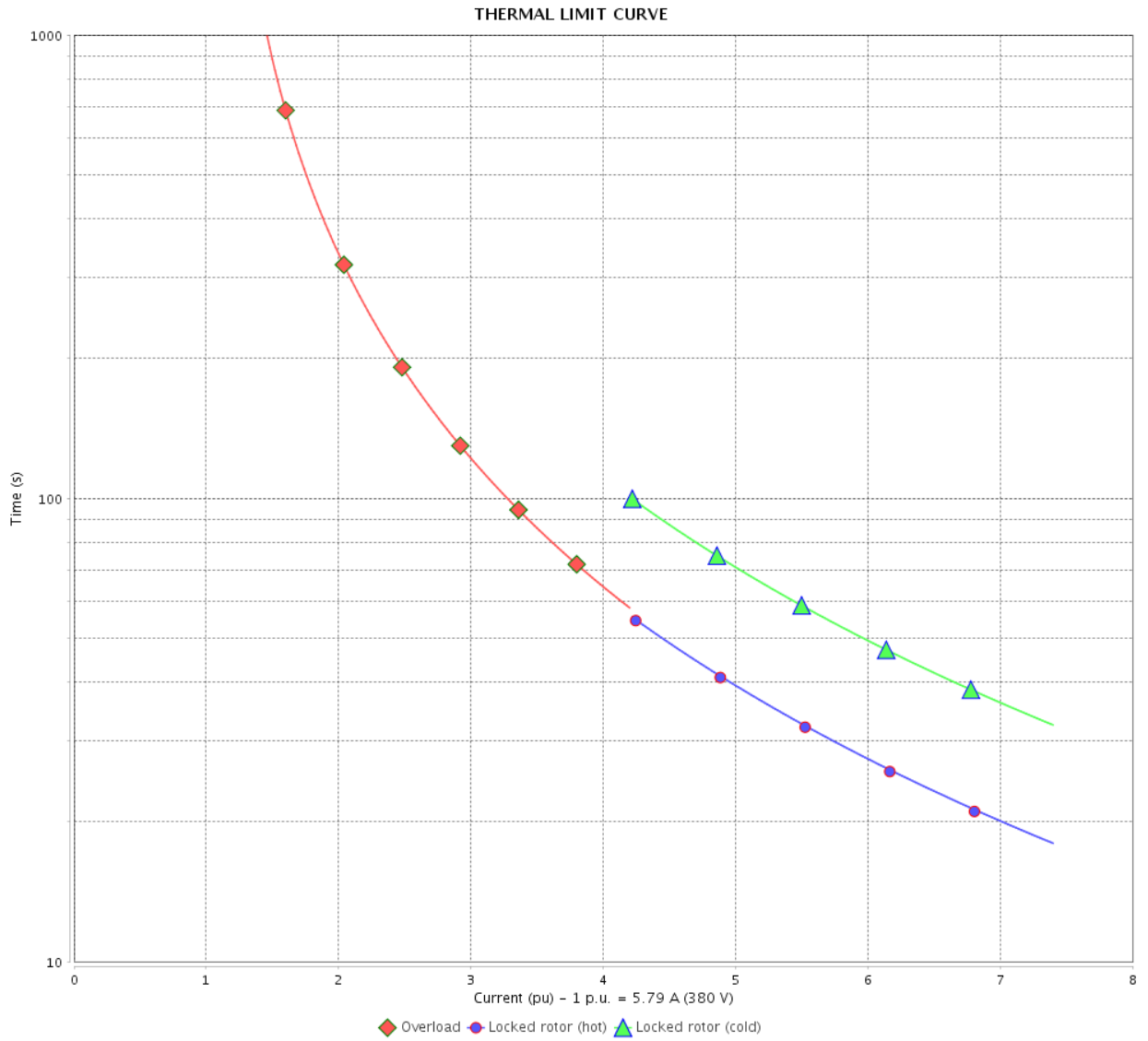

Rev.	Changes Summary	Performed	Checked	Date
Performed by		Page		Revision
Checked by		19 / 36		
Date		13/04/2022		

THERMAL LIMIT CURVE



Three Phase Induction Motor - Squirrel Cage

Customer :

Product line : NEMA Premium Efficiency Three-Phase
Product code : 11431312
Catalog # : 00536ST3QIE184T-W22

Performance : 400 V 50 Hz 2P IE3

Rated current	: 5.57 A	Moment of inertia (J)	: 0.2233 sq.ft.lb
LRC	: 8.1	Duty cycle	: Cont.(S1)
Rated torque	: 7.24 ft.lb	Insulation class	: F
Locked rotor torque	: 270 %	Service factor	: 1.25
Breakdown torque	: 370 %	Temperature rise	: 80 K
Rated speed	: 2900 rpm	Design	: B

Heating constant

Cooling constant

Rev.	Changes Summary	Performed	Checked	Date
Performed by				
Checked by				
Date	13/04/2022		Page 20 / 36	Revision

THERMAL LIMIT CURVE

Three Phase Induction Motor - Squirrel Cage



Customer : _____

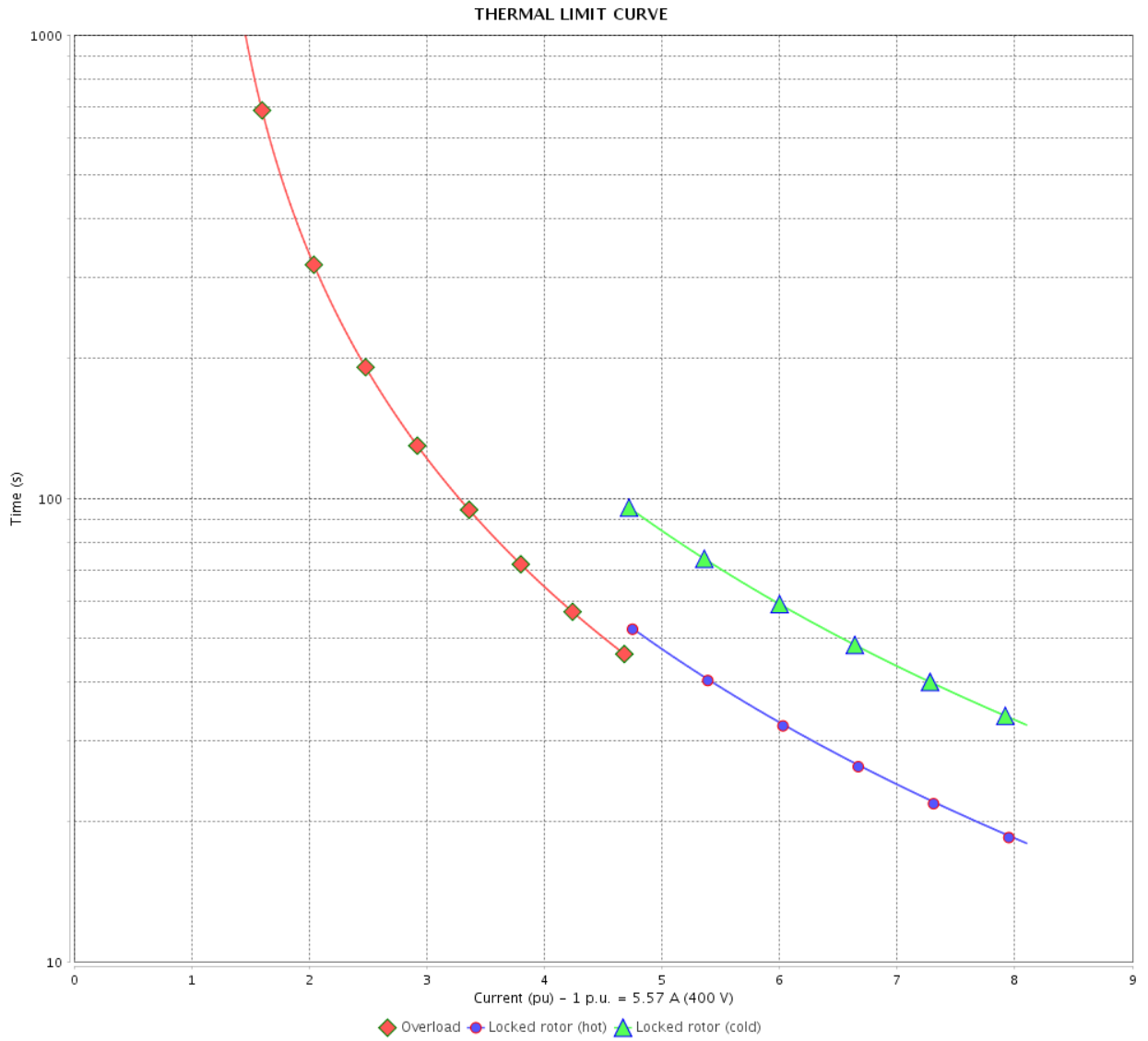

Rev.	Changes Summary	Performed	Checked	Date
Performed by		Page		Revision
Checked by		21 / 36		
Date		13/04/2022		

THERMAL LIMIT CURVE



Three Phase Induction Motor - Squirrel Cage

Customer :

Product line : NEMA Premium Efficiency Three-Phase
Product code : 11431312
Catalog # : 00536ST3QIE184T-W22

Performance : 415 V 50 Hz 2P IE3

Rated current	: 5.43 A	Moment of inertia (J)	: 0.2233 sq.ft.lb
LRC	: 8.9	Duty cycle	: Cont.(S1)
Rated torque	: 7.22 ft.lb	Insulation class	: F
Locked rotor torque	: 300 %	Service factor	: 1.25
Breakdown torque	: 400 %	Temperature rise	: 80 K
Rated speed	: 2910 rpm	Design	: B

Heating constant

Cooling constant

Rev.	Changes Summary	Performed	Checked	Date
Performed by				
Checked by			Page	Revision
Date	13/04/2022		22 / 36	

THERMAL LIMIT CURVE

Three Phase Induction Motor - Squirrel Cage



Customer : _____

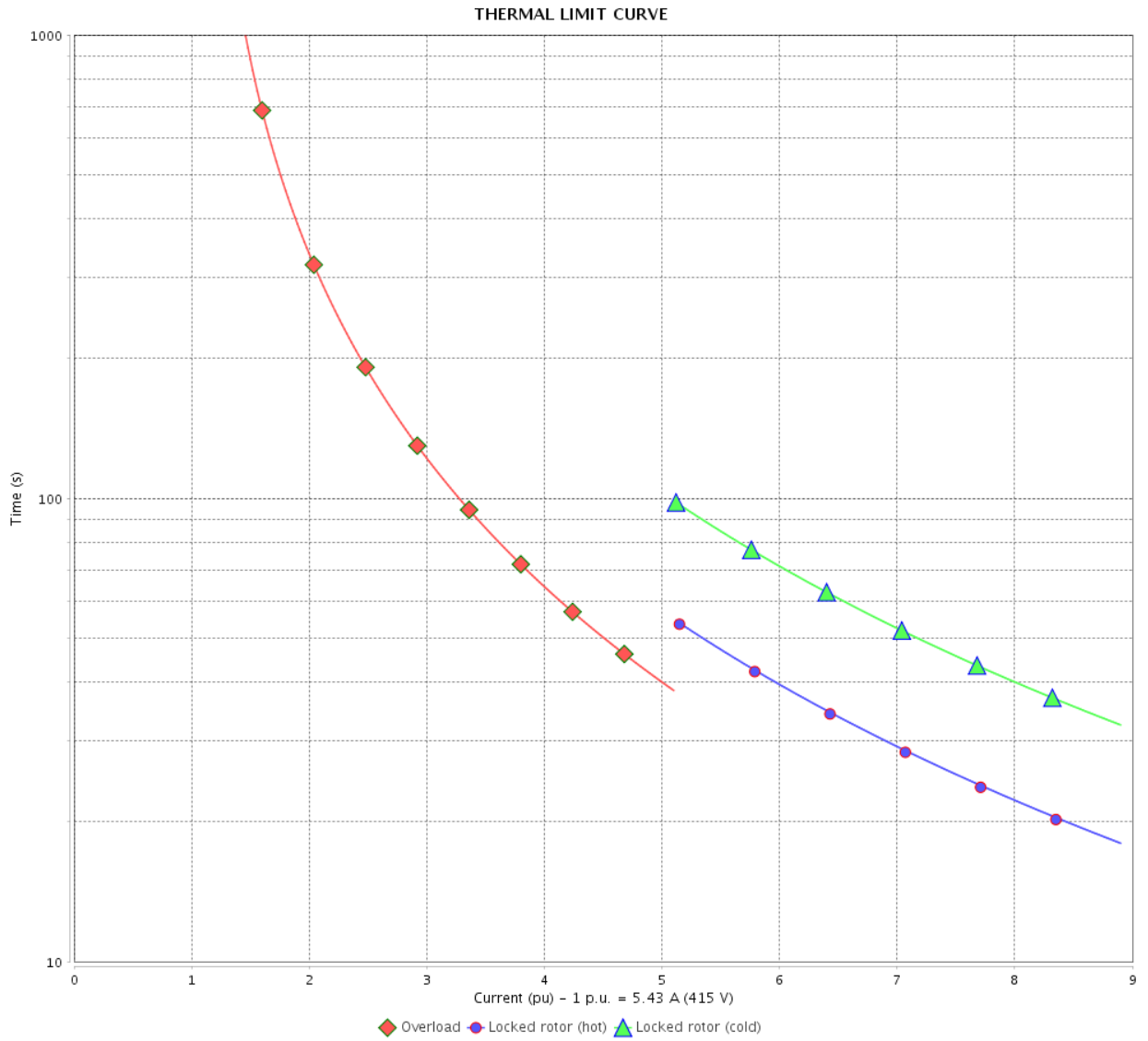

Rev.	Changes Summary	Performed	Checked	Date
Performed by		Page 23 / 36		Revision
Checked by				
Date				

THERMAL LIMIT CURVE

Three Phase Induction Motor - Squirrel Cage



Customer :

Product line : NEMA Premium Efficiency Three-Phase
Product code : 11431312
Catalog # : 00536ST3QIE184T-W22

Performance : 380 V 50 Hz 2P IE2

Rated current	: 7.14 A	Moment of inertia (J)	: 0.2233 sq.ft.lb
LRC	: 5.9	Duty cycle	: Cont.(S1)
Rated torque	: 9.21 ft.lb	Insulation class	: F
Locked rotor torque	: 180 %	Service factor	: 1.25
Breakdown torque	: 250 %	Temperature rise	: 80 K
Rated speed	: 2850 rpm	Design	: B

Heating constant

Cooling constant

Rev.	Changes Summary	Performed	Checked	Date
Performed by				
Checked by			Page	Revision
Date	13/04/2022		24 / 36	

THERMAL LIMIT CURVE

Three Phase Induction Motor - Squirrel Cage



Customer : _____

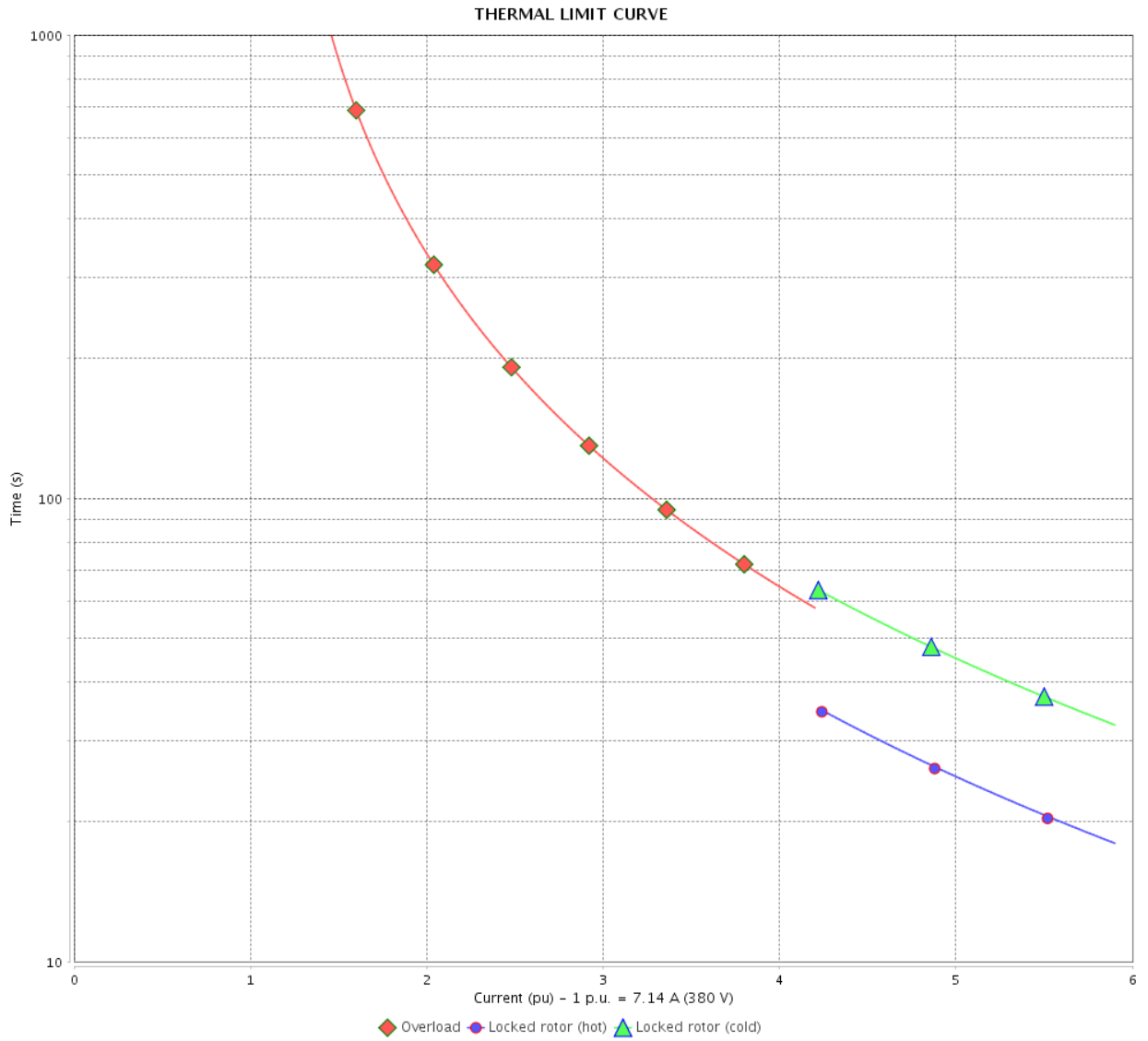

Rev.	Changes Summary	Performed	Checked	Date
Performed by		Page 25 / 36		Revision
Checked by				
Date				

THERMAL LIMIT CURVE

Three Phase Induction Motor - Squirrel Cage



Customer :

Product line : NEMA Premium Efficiency Three-Phase

Product code : 11431312

Catalog # : 00536ST3QIE184T-W22

Performance : 400 V 50 Hz 2P IE2

Rated current : 6.78 A
LRC : 6.6
Rated torque : 9.15 ft.lb
Locked rotor torque : 210 %
Breakdown torque : 290 %
Rated speed : 2870 rpm

Moment of inertia (J) : 0.2233 sq.ft.lb
Duty cycle : Cont.(S1)
Insulation class : F
Service factor : 1.25
Temperature rise : 80 K
Design : B

Heating constant

Cooling constant

Rev.	Changes Summary	Performed	Checked	Date
Performed by				
Checked by			Page	Revision
Date	13/04/2022		26 / 36	

THERMAL LIMIT CURVE

Three Phase Induction Motor - Squirrel Cage



Customer : _____

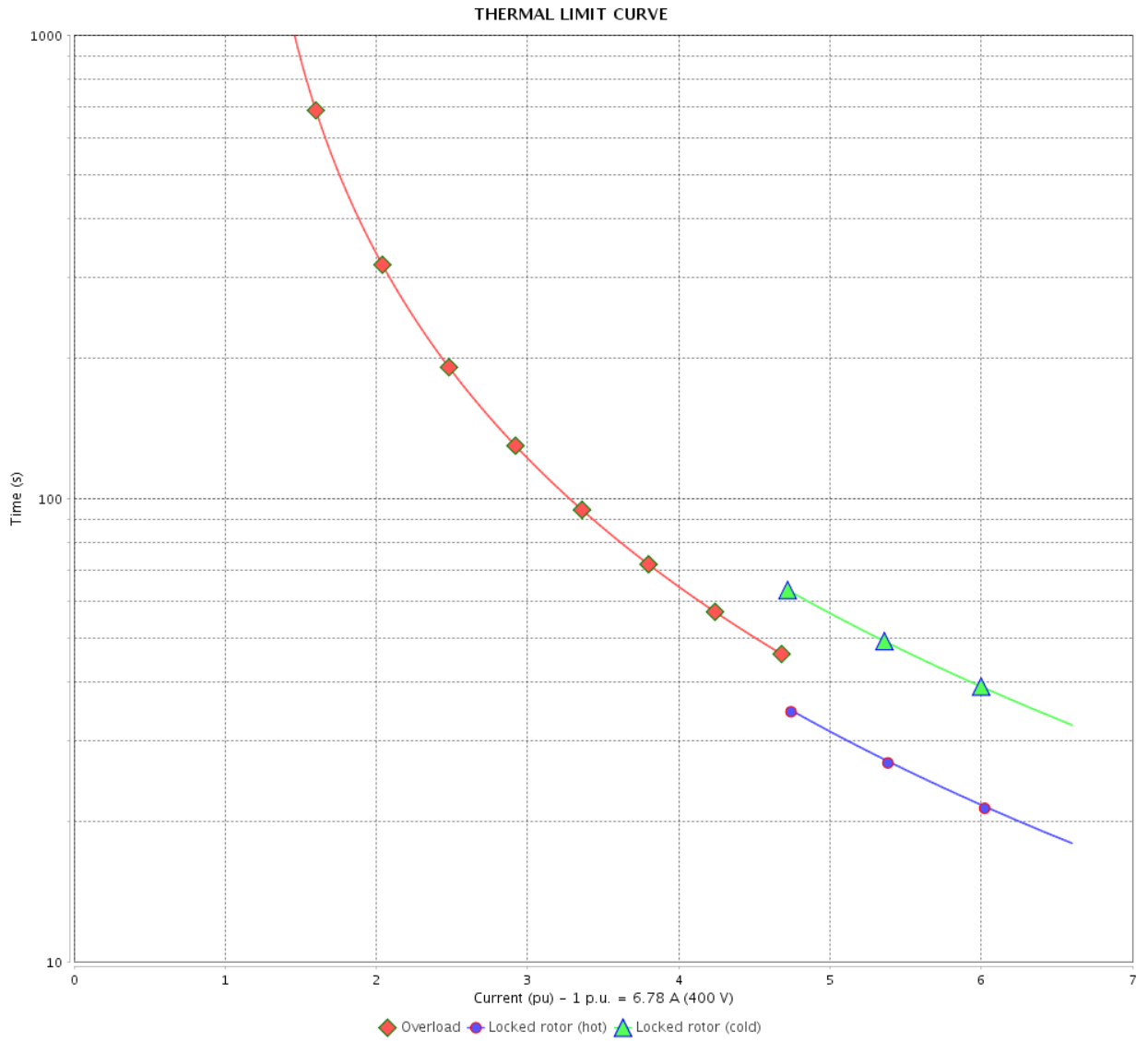

Rev.	Changes Summary	Performed	Checked	Date
Performed by		Page 27 / 36		Revision
Checked by				
Date				

THERMAL LIMIT CURVE



Three Phase Induction Motor - Squirrel Cage

Customer :

Product line : NEMA Premium Efficiency Three-Phase
Product code : 11431312
Catalog # : 00536ST3QIE184T-W22

Performance : 415 V 50 Hz 2P IE2

Rated current	: 6.61 A	Moment of inertia (J)	: 0.2233 sq.ft.lb
LRC	: 7.2	Duty cycle	: Cont.(S1)
Rated torque	: 9.12 ft.lb	Insulation class	: F
Locked rotor torque	: 240 %	Service factor	: 1.25
Breakdown torque	: 320 %	Temperature rise	: 80 K
Rated speed	: 2880 rpm	Design	: B

Heating constant

Cooling constant

Rev.	Changes Summary	Performed	Checked	Date
Performed by				
Checked by			Page	Revision
Date	13/04/2022		28 / 36	

THERMAL LIMIT CURVE

Three Phase Induction Motor - Squirrel Cage



Customer : _____

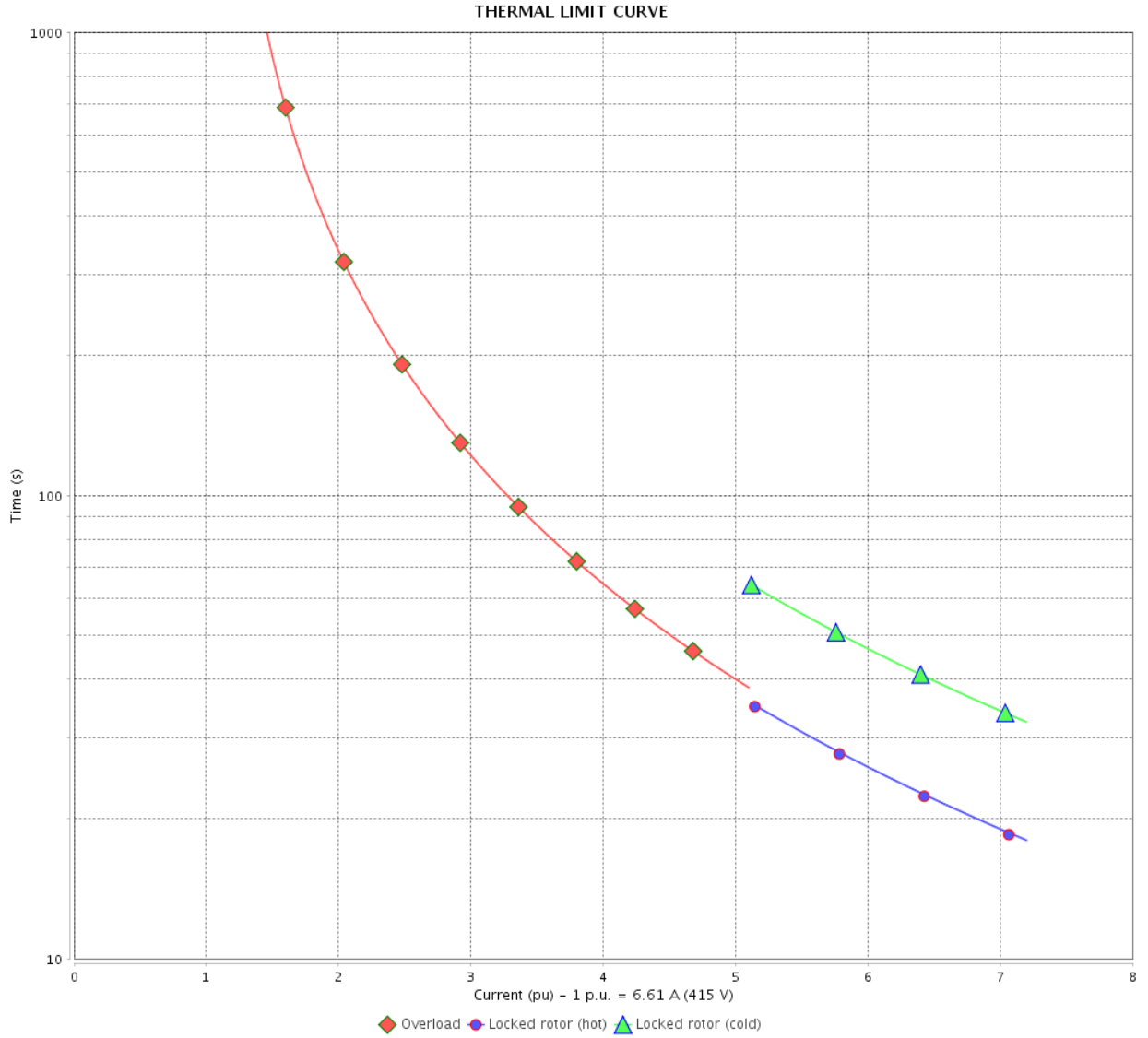

Rev.	Changes Summary	Performed	Checked	Date
Performed by		Page 29 / 36		Revision
Checked by				
Date				

VFD OPERATION CURVE

Three Phase Induction Motor - Squirrel Cage



Customer :

Product line : NEMA Premium Efficiency Three-Phase

Product code : 11431312

Catalog # : 00536ST3QIE184T-W22

VFD OPERATION CURVE

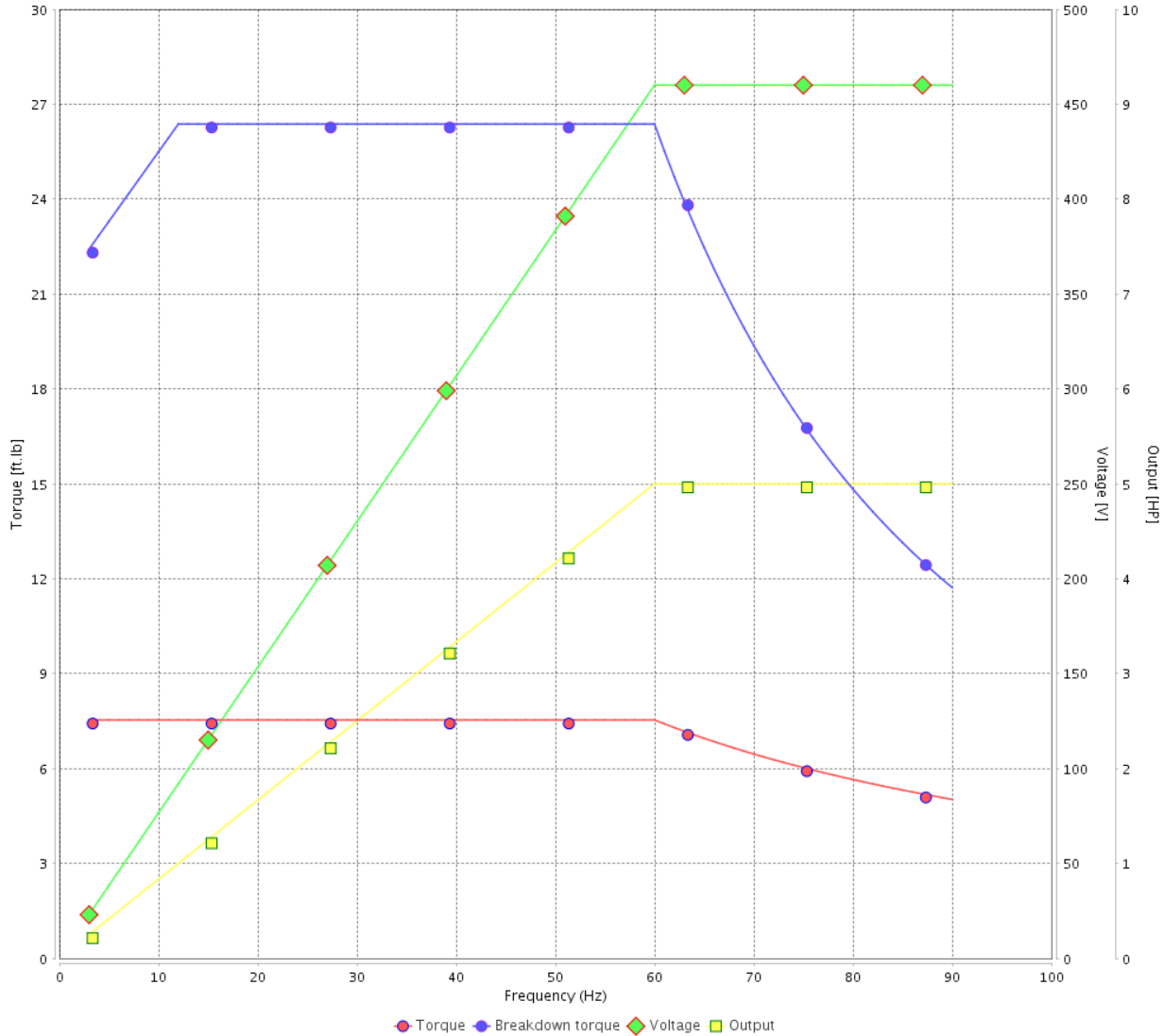

Performance : 460 V 60 Hz 2P

Rated current : 5.90 A
 LRC : 7.6
 Rated torque : 7.53 ft.lb
 Locked rotor torque : 229 %
 Breakdown torque : 350 %
 Rated speed : 3485 rpm

Moment of inertia (J) : 0.2233 sq.ft.lb
 Duty cycle : Cont.(S1)
 Insulation class : F
 Service factor : 1.25
 Temperature rise : 80 K
 Design : B

Rev.	Changes Summary	Performed	Checked	Date
Performed by			Page	Revision
Checked by				
Date				

VFD OPERATION CURVE

Three Phase Induction Motor - Squirrel Cage



Customer :

Product line : NEMA Premium Efficiency Three-Phase

Product code : 11431312

Catalog # : 00536ST3QIE184T-W22

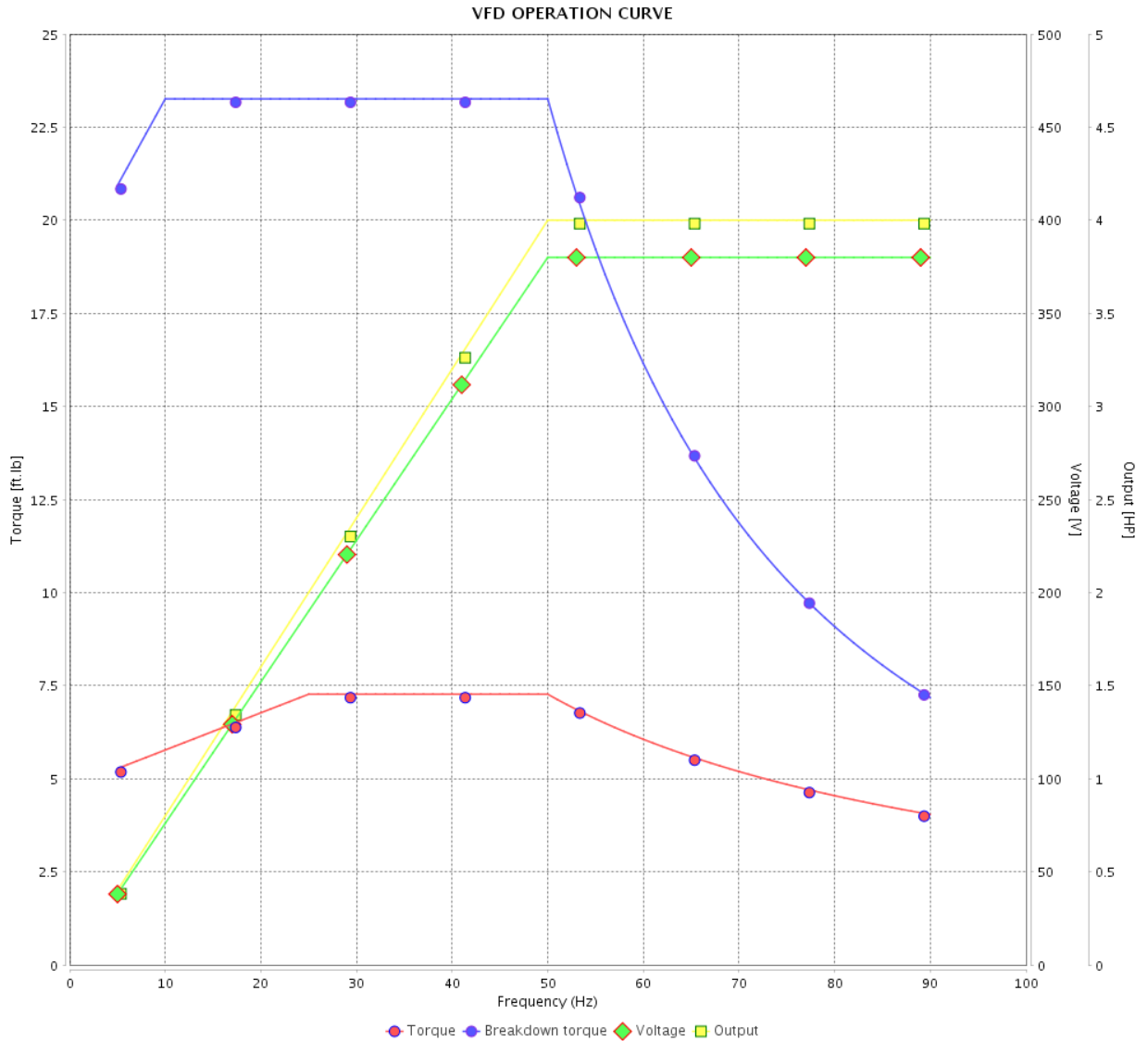

Performance : 380 V 50 Hz 2P IE3

Rated current : 5.79 A
 LRC : 7.4
 Rated torque : 7.27 ft.lb
 Locked rotor torque : 229 %
 Breakdown torque : 320 %
 Rated speed : 2890 rpm

Moment of inertia (J) : 0.2233 sq.ft.lb
 Duty cycle : Cont.(S1)
 Insulation class : F
 Service factor : 1.25
 Temperature rise : 80 K
 Design : B

Rev.	Changes Summary	Performed	Checked	Date
Performed by			Page	Revision
Checked by			31 / 36	
Date	13/04/2022			

VFD OPERATION CURVE

Three Phase Induction Motor - Squirrel Cage



Customer : _____

Product line : NEMA Premium Efficiency Three-Phase

Product code : 11431312

Catalog # : 00536ST3QIE184T-W22

VFD OPERATION CURVE

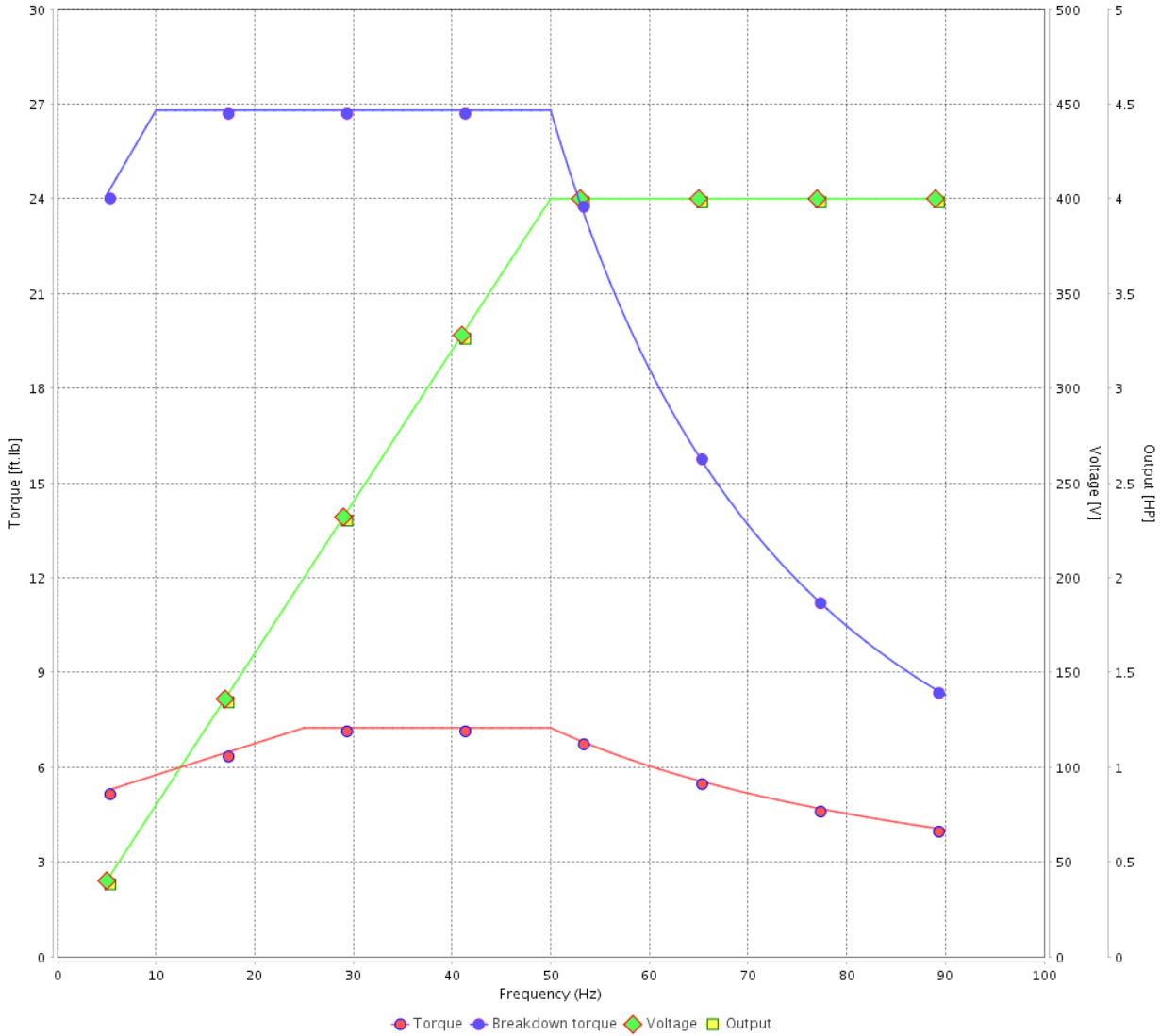

Performance : 400 V 50 Hz 2P IE3

Rated current : 5.57 A
 LRC : 8.1
 Rated torque : 7.24 ft.lb
 Locked rotor torque : 270 %
 Breakdown torque : 370 %
 Rated speed : 2900 rpm

Moment of inertia (J) : 0.2233 sq.ft.lb
 Duty cycle : Cont.(S1)
 Insulation class : F
 Service factor : 1.25
 Temperature rise : 80 K
 Design : B

Rev.	Changes Summary	Performed	Checked	Date
Performed by			Page 32 / 36	Revision
Checked by				
Date	13/04/2022			

VFD OPERATION CURVE

Three Phase Induction Motor - Squirrel Cage



Customer :

Product line : NEMA Premium Efficiency Three-Phase

Product code : 11431312

Catalog # : 00536ST3QIE184T-W22

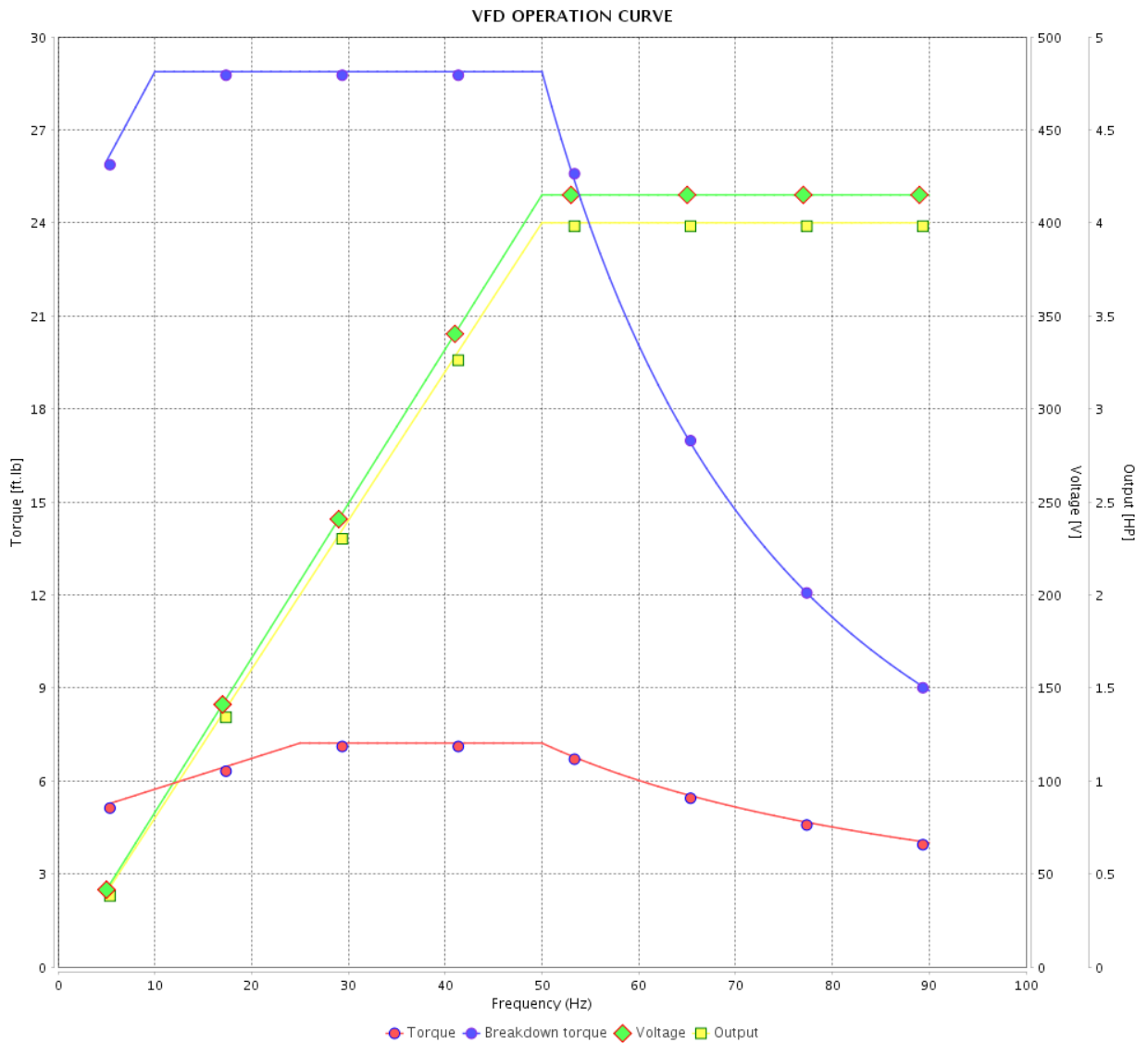

Performance : 415 V 50 Hz 2P IE3

Rated current : 5.43 A
 LRC : 8.9
 Rated torque : 7.22 ft.lb
 Locked rotor torque : 300 %
 Breakdown torque : 400 %
 Rated speed : 2910 rpm

Moment of inertia (J) : 0.2233 sq.ft.lb
 Duty cycle : Cont.(S1)
 Insulation class : F
 Service factor : 1.25
 Temperature rise : 80 K
 Design : B

Rev.	Changes Summary	Performed	Checked	Date
Performed by		Page		Revision
Checked by		33 / 36		
Date		13/04/2022		

VFD OPERATION CURVE

Three Phase Induction Motor - Squirrel Cage



Customer :

Product line : NEMA Premium Efficiency Three-Phase

Product code : 11431312

Catalog # : 00536ST3QIE184T-W22

VFD OPERATION CURVE

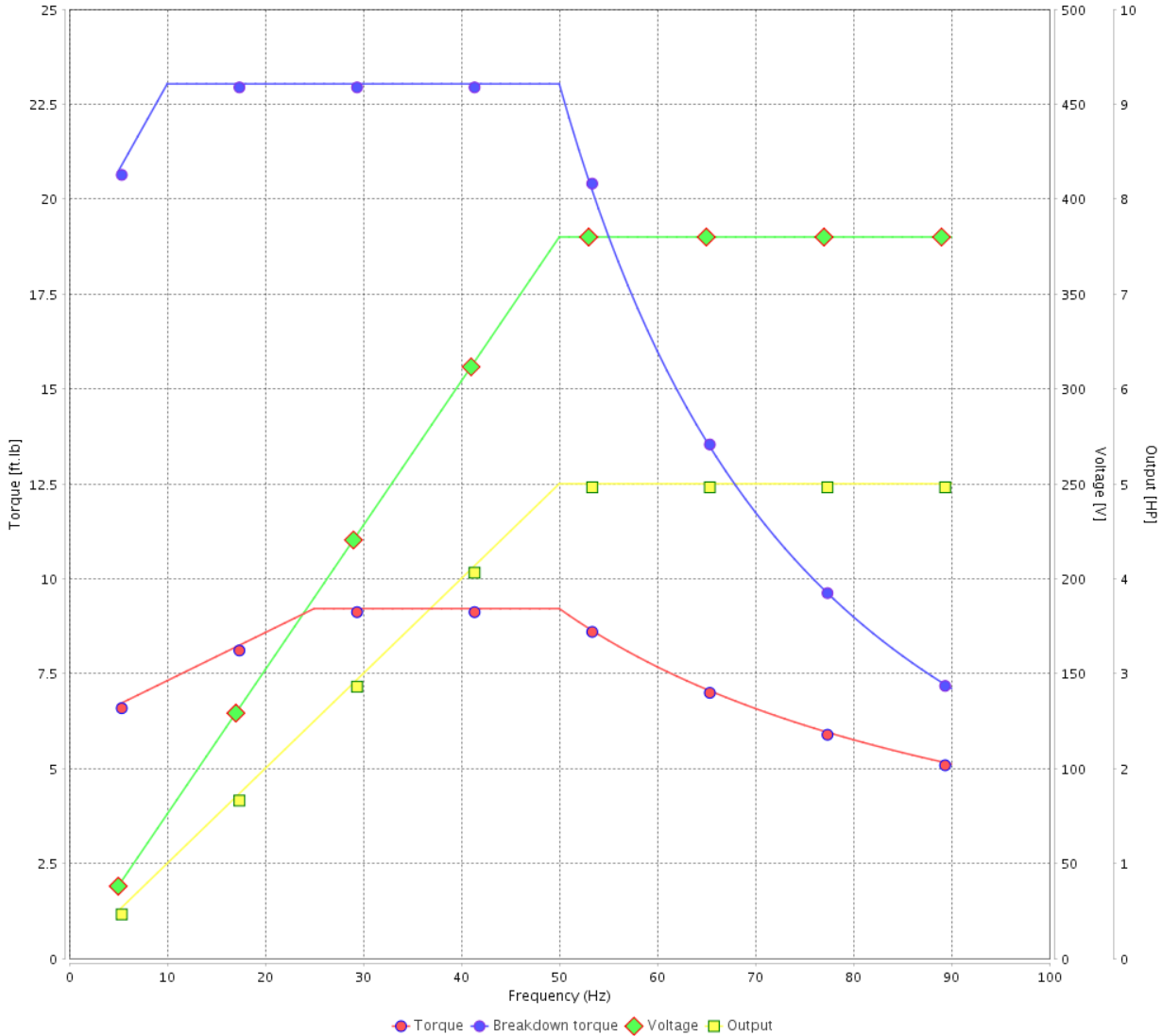

Performance : 380 V 50 Hz 2P IE2

Rated current : 7.14 A
 LRC : 5.9
 Rated torque : 9.21 ft.lb
 Locked rotor torque : 180 %
 Breakdown torque : 250 %
 Rated speed : 2850 rpm

Moment of inertia (J) : 0.2233 sq.ft.lb
 Duty cycle : Cont.(S1)
 Insulation class : F
 Service factor : 1.25
 Temperature rise : 80 K
 Design : B

Rev.	Changes Summary	Performed	Checked	Date
Performed by			Page 34 / 36	Revision
Checked by				
Date	13/04/2022			

VFD OPERATION CURVE

Three Phase Induction Motor - Squirrel Cage



Customer :

Product line : NEMA Premium Efficiency Three-Phase

Product code : 11431312

Catalog # : 00536ST3QIE184T-W22

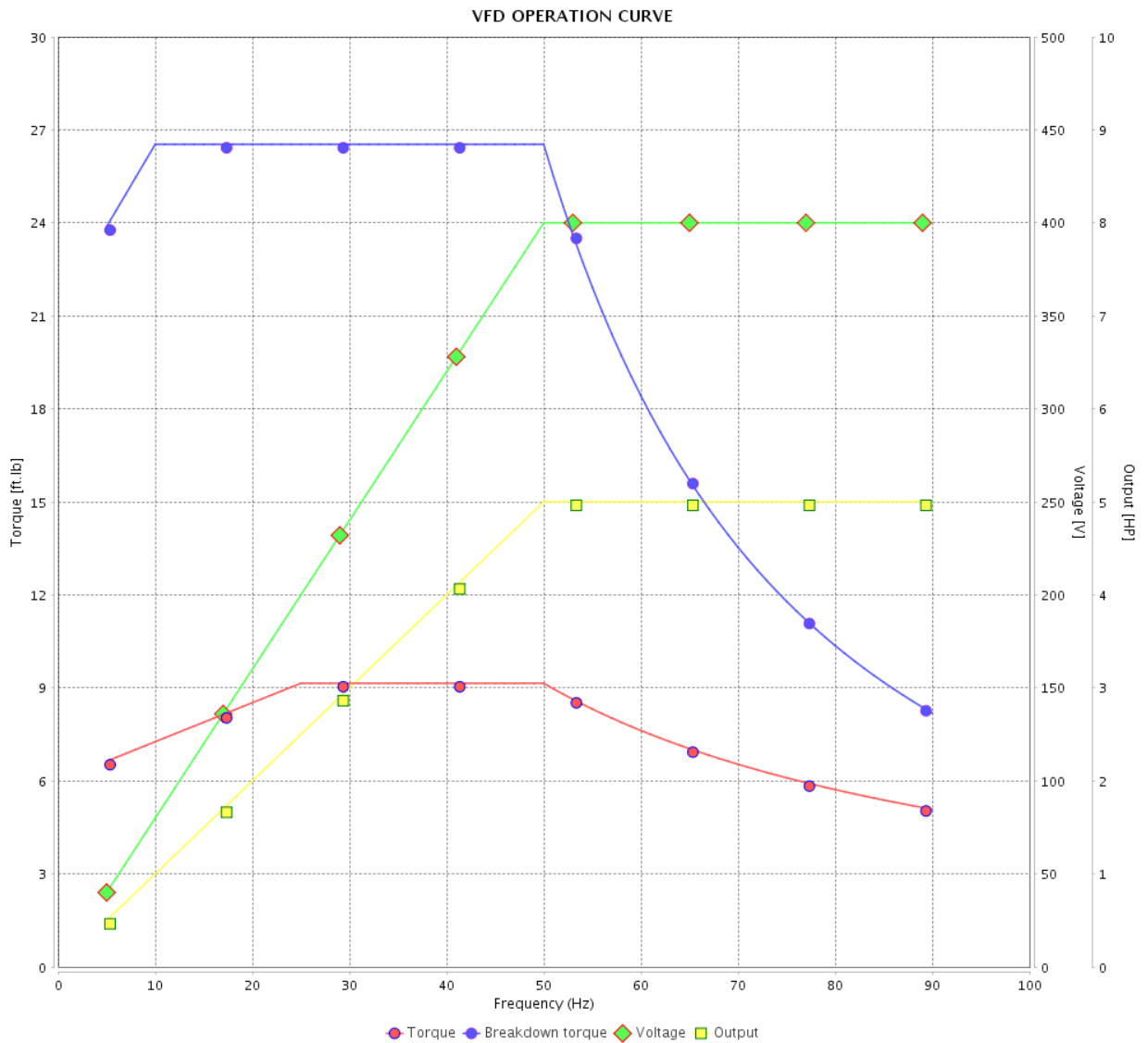

Performance : 400 V 50 Hz 2P IE2

Rated current : 6.78 A
 LRC : 6.6
 Rated torque : 9.15 ft.lb
 Locked rotor torque : 210 %
 Breakdown torque : 290 %
 Rated speed : 2870 rpm

Moment of inertia (J) : 0.2233 sq.ft.lb
 Duty cycle : Cont.(S1)
 Insulation class : F
 Service factor : 1.25
 Temperature rise : 80 K
 Design : B

Rev.	Changes Summary	Performed	Checked	Date
Performed by				Page 35 / 36
Checked by				
Date	13/04/2022			
				Revision

VFD OPERATION CURVE

Three Phase Induction Motor - Squirrel Cage



Customer : _____

Product line : NEMA Premium Efficiency Three-Phase

Product code : 11431312

Catalog # : 00536ST3QIE184T-W22

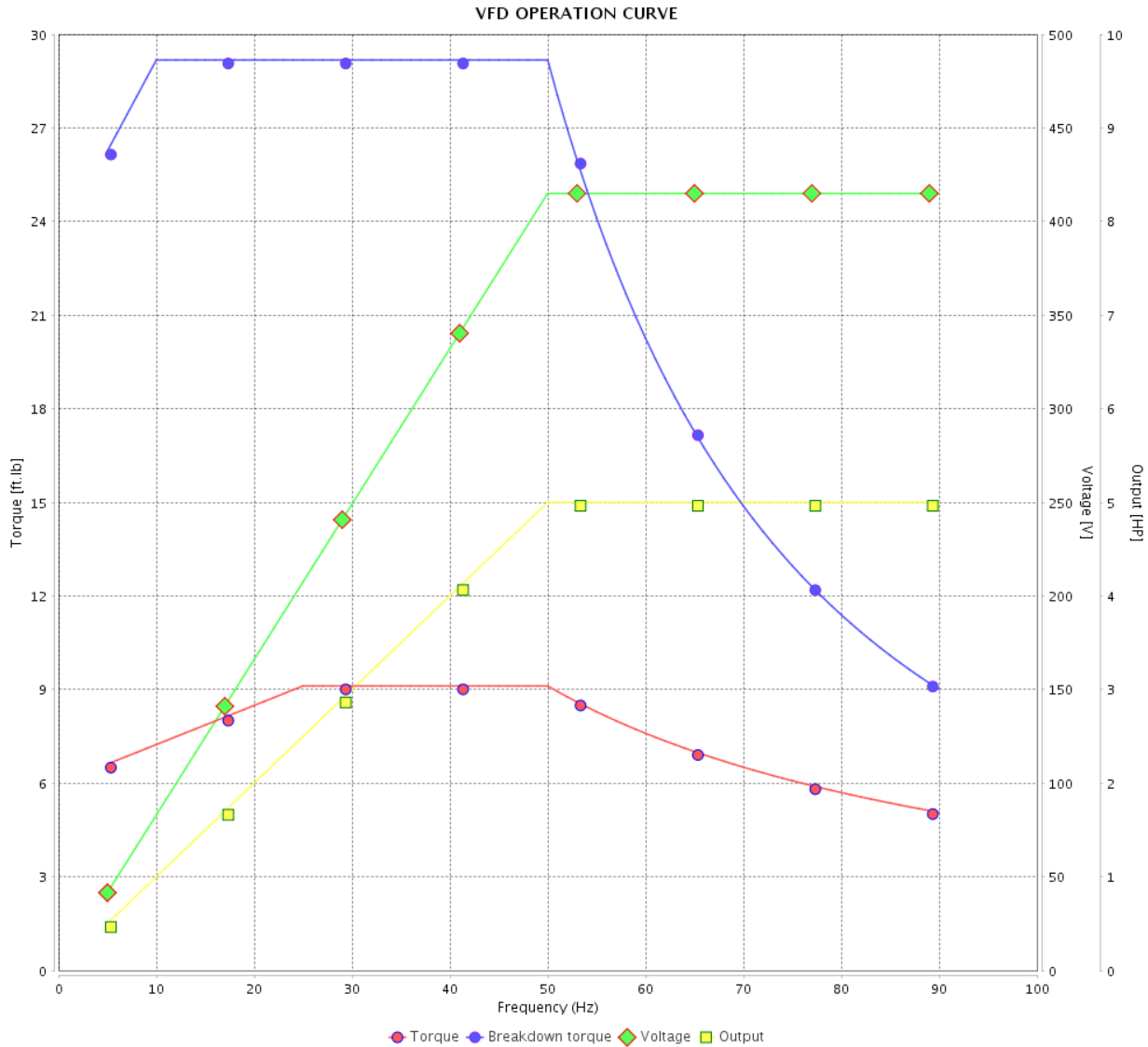

Performance : 415 V 50 Hz 2P IE2

Rated current : 6.61 A
 LRC : 7.2
 Rated torque : 9.12 ft.lb
 Locked rotor torque : 240 %
 Breakdown torque : 320 %
 Rated speed : 2880 rpm

Moment of inertia (J) : 0.2233 sq.ft.lb
 Duty cycle : Cont.(S1)
 Insulation class : F
 Service factor : 1.25
 Temperature rise : 80 K
 Design : B

Rev.	Changes Summary	Performed	Checked	Date
Performed by			Page 36 / 36	Revision
Checked by				
Date	13/04/2022			

1 2 3 4 5 6

A

B

C

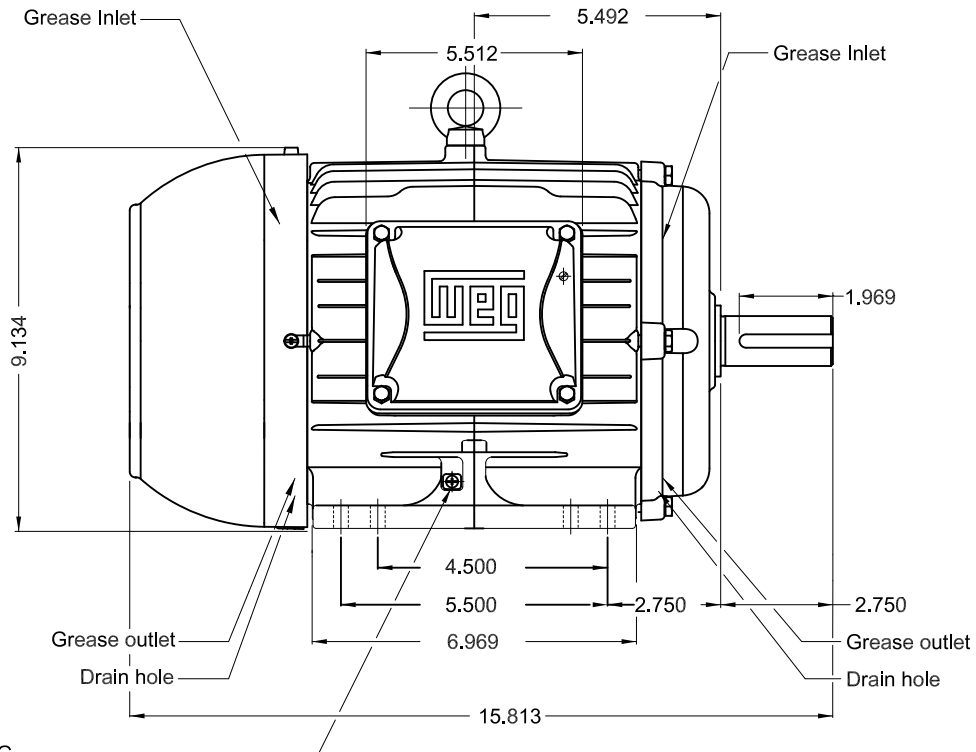
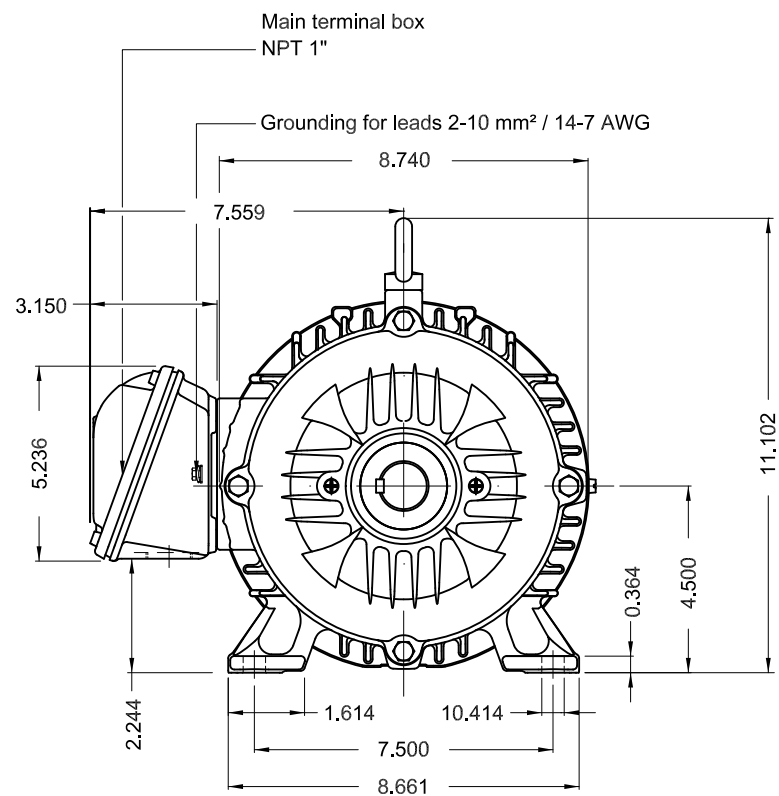

Grounding for leads 2-10 mm² / 14-7 AWG

D

E

Color RAL 5009
 Painting plan 202E
 Mounting B3R(D)

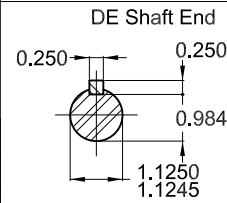

5 HP 02 Poles 60 Hz A

ECM	LOC	SUMMARY OF MODIFICATIONS	EXECUTED	CHECKED	RELEASED	DATE	VER
EXECUTED	PIRWBUSER	THREE PH. MOTOR IEEE 841 W22 PREM. EFF.					
CHECKED		FRAME 182/4T IP55 TEFC					
RELEASED							
REL DT.	WMO	Jaragua do Sul	Product Engineering	SHEET	1 / 1		

PREVIEW
WDD



Dimensions in inches XME A3

MADE IN BRAZIL
11431312



NEMA
Premium



Class I, Div 2, Gr A, B, C and D - T3
Class I, Zone 2, IIC - T3
Class II, Div 2, Gr F and G - T5
For use on PWM: Gr. A, B, C, D, F and G,
VT 1000:1, CT 20:1, 1.00SF - T4A

MODEL 00536ST3QIE184T-W22

Inverter Duty Motor
Severe Duty

IEEE
841-2009



FOR SAFE AREA
Mod. TE1BFOXON
CC029A

PH3 60Hz Fr. 182/4T 1000m.a.s.l. IP55 TEFC 110lb

V 460

A 5.90

HP 5.0

kW 3.7

SF 1.25

SFA 7.38

RPM 3485

PF 0.89

AMB 40°C

INS cl. F DT80K

NEMA NOM EFF 88.5%

DUTY CONT.

DES B Code J

GUARANT. EFF 86.5%

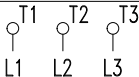

460V

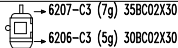

MOBIL POLYREX EM (20000h)

