

# DATA SHEET

## Three Phase Induction Motor - Squirrel Cage



Customer					
Product line	: NEMA Premium Efficiency Three-Phase	Product code :	12378979		
		Catalog # :	00718ST3QIE213T-W22		
Frame	: 213/5T	Cooling method	: IC411 - TEFC		
Insulation class	: F	Mounting	: F-1		
Duty cycle	: Cont.(S1)	Rotation <sup>1</sup>	: Both (CW and CCW)		
Ambient temperature	: -20°C to +40°C	Starting method	: Direct On Line		
Altitude	: 1000 m.a.s.l.	Approx. weight <sup>2</sup>	: 177 lb		
Protection degree	: IP55	Moment of inertia (J)	: 1.34 sq.ft.lb		
Design	: B				
Output [HP]	7.5	7.5	7.5	7.5	7.5
Poles	4	4	4	4	4
Frequency [Hz]	60	50	50	50	50
Rated voltage [V]	460	380	400	415	415
Rated current [A]	9.18	11.0	10.5	10.3	10.3
L. R. Amperes [A]	65.2	61.6	65.1	69.0	69.0
LRC [A]	7.1x(Code H)	5.6x(Code F)	6.2x(Code G)	6.7x(Code H)	6.7x(Code H)
No load current [A]	4.40	4.00	4.30	4.55	4.55
Rated speed [RPM]	1765	1455	1460	1460	1460
Slip [%]	1.94	3.00	2.67	2.67	2.67
Rated torque [ft.lb]	22.3	27.1	27.0	27.0	27.0
Locked rotor torque [%]	220	170	190	210	210
Breakdown torque [%]	310	240	270	290	290
Service factor	1.25	1.25	1.25	1.25	1.25
Temperature rise	80 K	80 K	80 K	80 K	80 K
Locked rotor time	36s (cold) 20s (hot)	27s (cold) 15s (hot)	27s (cold) 15s (hot)	27s (cold) 15s (hot)	27s (cold) 15s (hot)
Noise level <sup>2</sup>	58.0 dB(A)	56.0 dB(A)	56.0 dB(A)	56.0 dB(A)	56.0 dB(A)
Efficiency (%)	25%				
	50%	89.5	89.5	89.5	89.5
	75%	91.0	89.5	90.2	90.2
	100%	91.7	89.6	90.2	90.2
Power Factor	25%				
	50%	0.66	0.72	0.69	0.66
	75%	0.76	0.81	0.78	0.76
	100%	0.82	0.85	0.84	0.82
Bearing type	: <u>Drive end</u> 6308 C3 <u>Non drive end</u> 6207 C3	Foundation loads			
Sealing	: Inpro/Seal Inpro/Seal	Max. traction	: 353 lb		
Lubrication interval	: 20000 h 20000 h	Max. compression	: 530 lb		
Lubricant amount	: 11 g 7 g				
Lubricant type	: Mobil Polyrex EM				
Notes					
This revision replaces and cancel the previous one, which must be eliminated. (1) Looking the motor from the shaft end. (2) Measured at 1m and with tolerance of +3dB(A). (3) Approximate weight subject to changes after manufacturing process. (4) At 100% of full load.			These are average values based on tests with sinusoidal power supply, subject to the tolerances stipulated in NEMA MG-1.		
Rev.	Changes Summary		Performed	Checked	Date
Performed by					
Checked by				Page	Revision
Date	13/04/2022			1 / 21	

# TORQUE AND CURRENT VS SPEED CURVE

## Three Phase Induction Motor - Squirrel Cage



Customer :

Product line : NEMA Premium Efficiency Three-Phase

Product code : 12378979

Catalog # : 00718ST3QIE213T-W22

TORQUE AND CURRENT VS SPEED CURVE

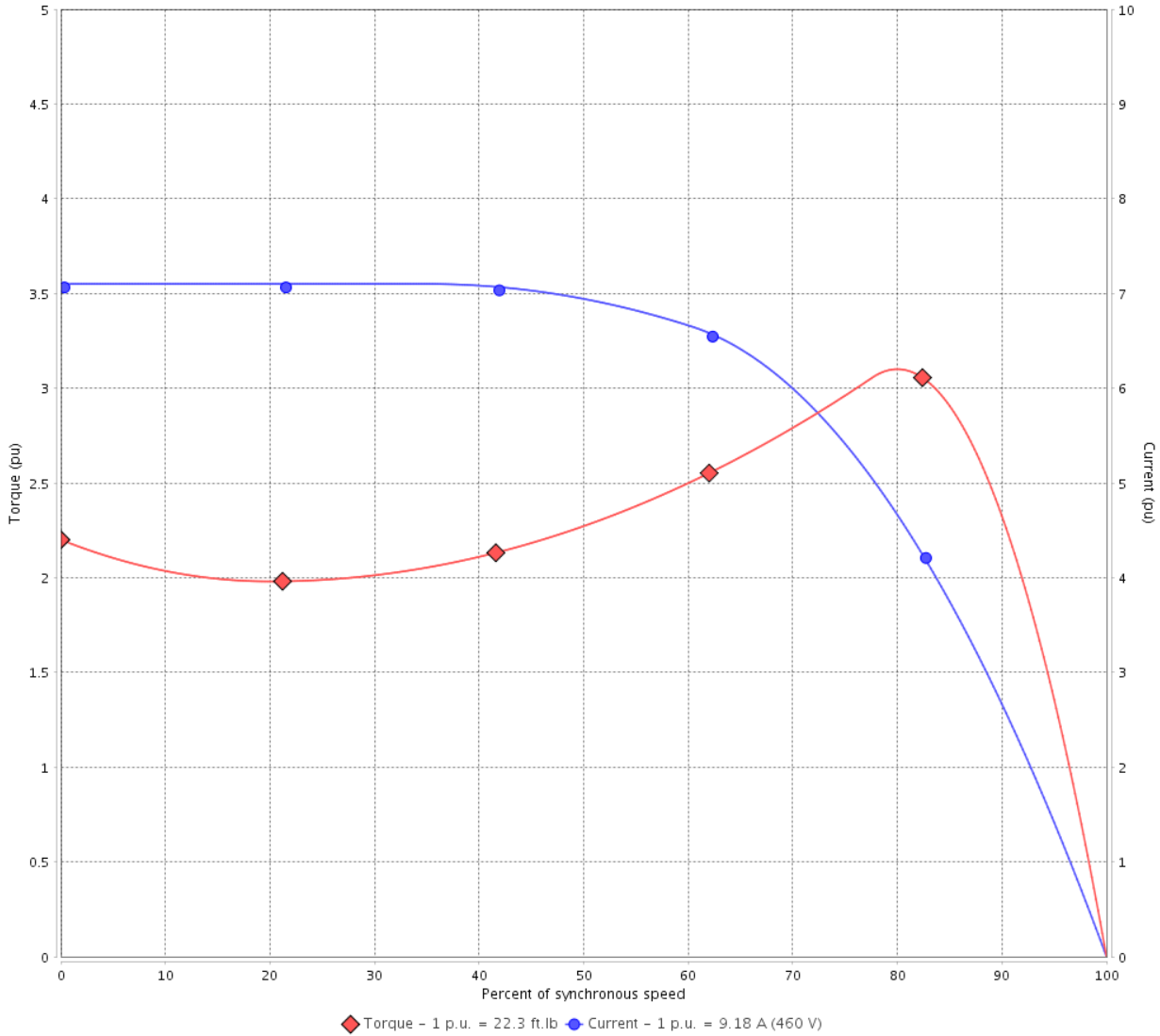

Performance : 460 V 60 Hz 4P

Rated current	: 9.18 A	Moment of inertia (J)	: 1.34 sq.ft.lb
LRC	: 7.1	Duty cycle	: Cont.(S1)
Rated torque	: 22.3 ft.lb	Insulation class	: F
Locked rotor torque	: 220 %	Service factor	: 1.25
Breakdown torque	: 310 %	Temperature rise	: 80 K
Rated speed	: 1765 rpm	Design	: B

Locked rotor time : 36s (cold) 20s (hot)

Rev.	Changes Summary	Performed	Checked	Date
Performed by			Page 2 / 21	Revision
Checked by				
Date	13/04/2022			

# TORQUE AND CURRENT VS SPEED CURVE



## Three Phase Induction Motor - Squirrel Cage

Customer :

Product line : NEMA Premium Efficiency Three-Phase

Product code : 12378979

Catalog # : 00718ST3QIE213T-W22

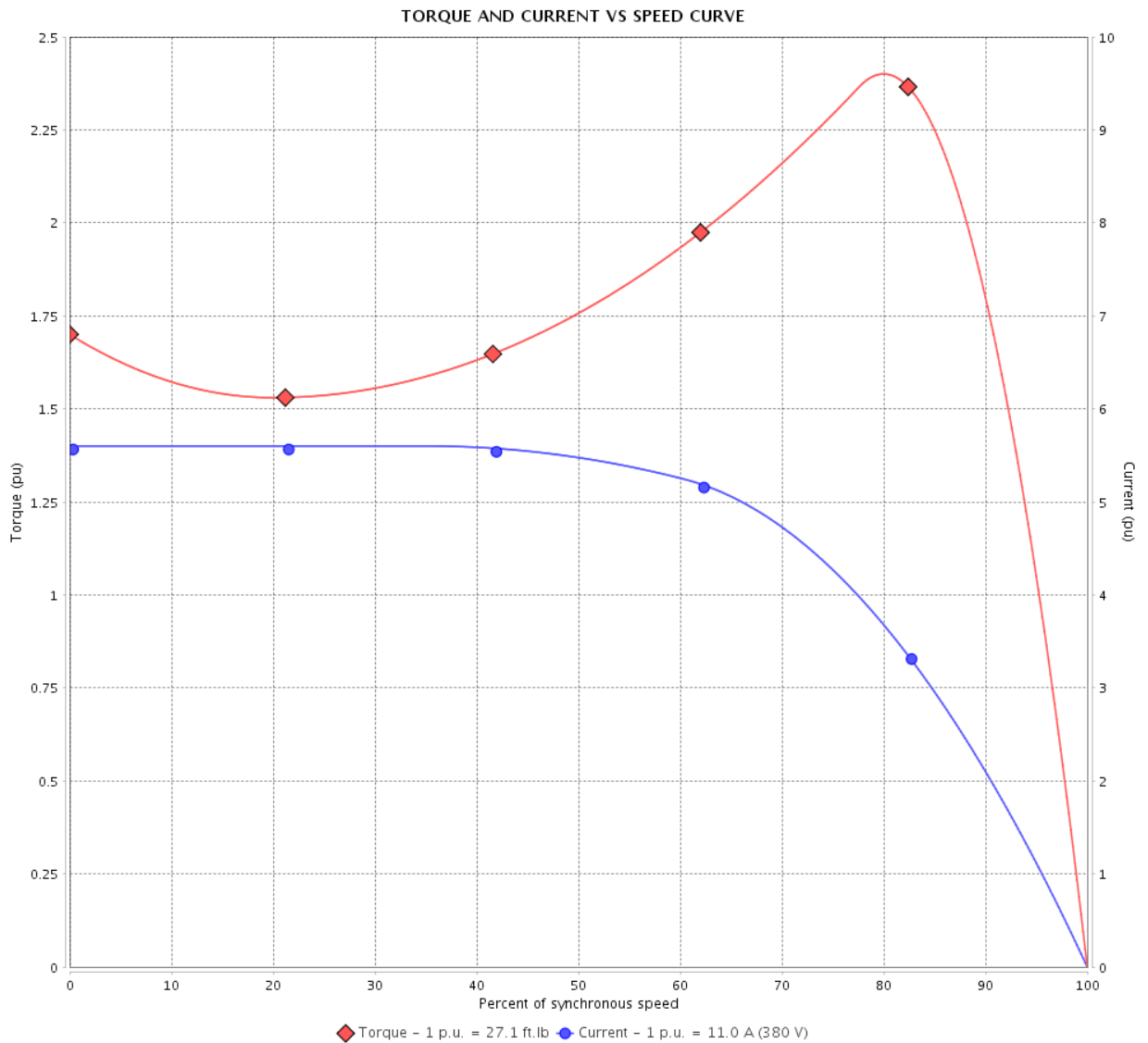

Performance : 380 V 50 Hz 4P IE3

Rated current : 11.0 A  
 LRC : 5.6  
 Rated torque : 27.1 ft.lb  
 Locked rotor torque : 170 %  
 Breakdown torque : 240 %  
 Rated speed : 1455 rpm

Moment of inertia (J) : 1.34 sq.ft.lb  
 Duty cycle : Cont.(S1)  
 Insulation class : F  
 Service factor : 1.25  
 Temperature rise : 80 K  
 Design : B

Locked rotor time : 27s (cold) 15s (hot)

Rev.	Changes Summary	Performed	Checked	Date
Performed by			Page 3 / 21	Revision
Checked by				
Date	13/04/2022			

# TORQUE AND CURRENT VS SPEED CURVE

Three Phase Induction Motor - Squirrel Cage



Customer :

Product line : NEMA Premium Efficiency Three-Phase

Product code : 12378979

Catalog # : 00718ST3QIE213T-W22

TORQUE AND CURRENT VS SPEED CURVE

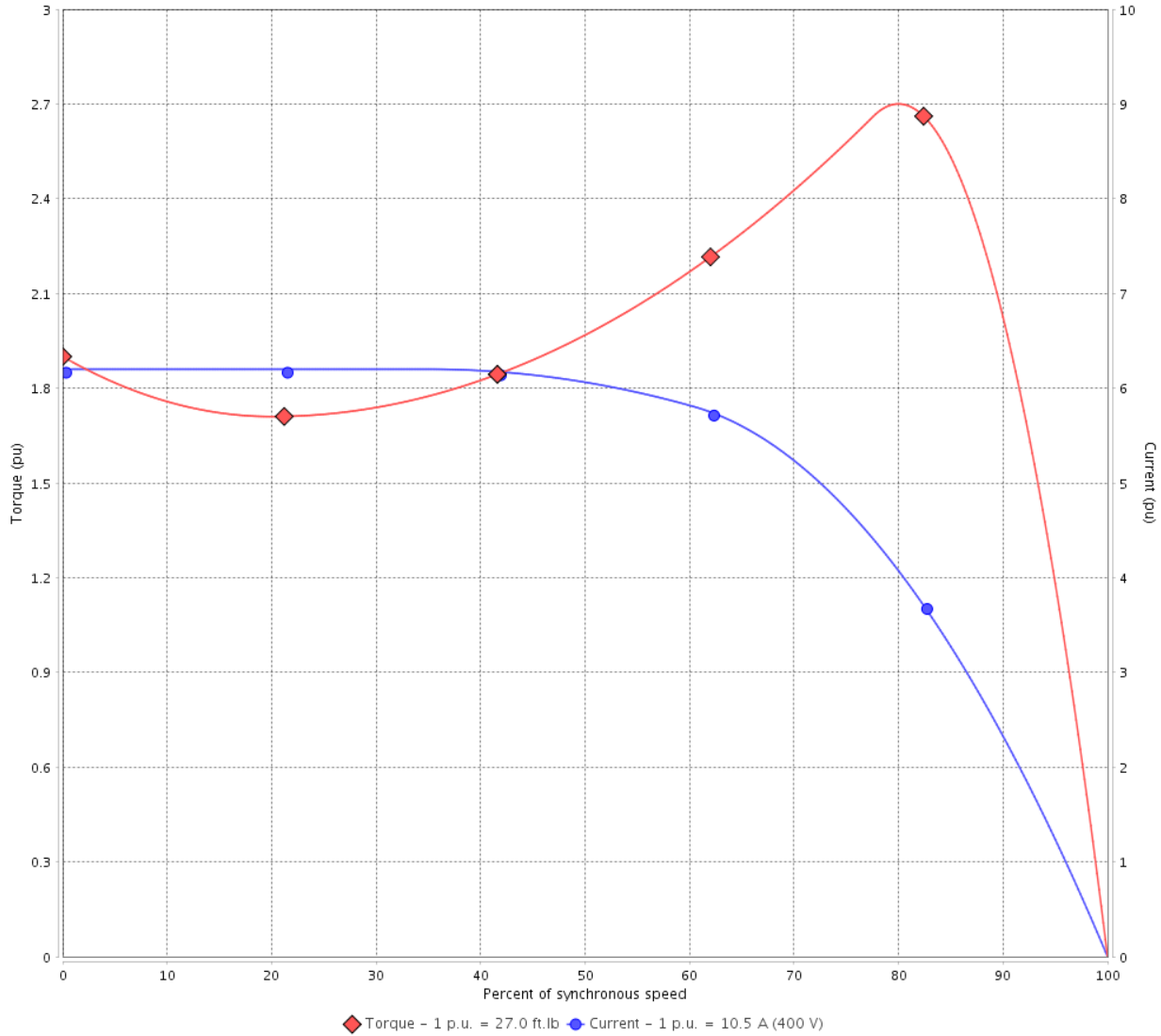

Performance : 400 V 50 Hz 4P IE3

Rated current	: 10.5 A	Moment of inertia (J)	: 1.34 sq.ft.lb
LRC	: 6.2	Duty cycle	: Cont.(S1)
Rated torque	: 27.0 ft.lb	Insulation class	: F
Locked rotor torque	: 190 %	Service factor	: 1.25
Breakdown torque	: 270 %	Temperature rise	: 80 K
Rated speed	: 1460 rpm	Design	: B

Locked rotor time : 27s (cold) 15s (hot)

Rev.	Changes Summary	Performed	Checked	Date
Performed by			Page 4 / 21	Revision
Checked by				
Date	13/04/2022			

# TORQUE AND CURRENT VS SPEED CURVE



## Three Phase Induction Motor - Squirrel Cage

Customer :

Product line : NEMA Premium Efficiency Three-Phase

Product code : 12378979

Catalog # : 00718ST3QIE213T-W22

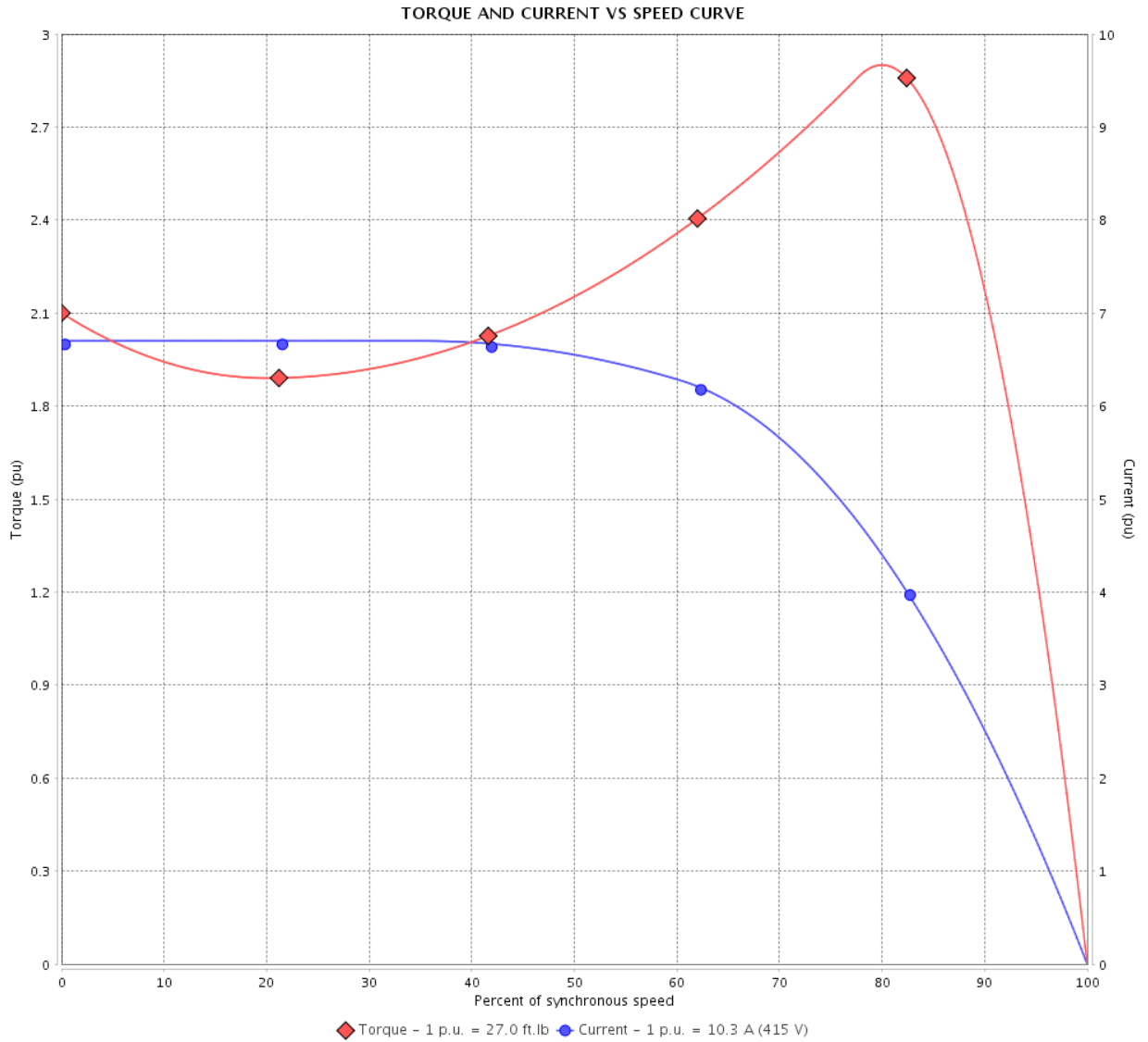

Performance : 415 V 50 Hz 4P IE3

Rated current	: 10.3 A	Moment of inertia (J)	: 1.34 sq.ft.lb
LRC	: 6.7	Duty cycle	: Cont.(S1)
Rated torque	: 27.0 ft.lb	Insulation class	: F
Locked rotor torque	: 210 %	Service factor	: 1.25
Breakdown torque	: 290 %	Temperature rise	: 80 K
Rated speed	: 1460 rpm	Design	: B

Locked rotor time : 27s (cold) 15s (hot)

Rev.	Changes Summary	Performed	Checked	Date
Performed by		Page		Revision
Checked by		5 / 21		
Date	13/04/2022			

# LOAD PERFORMANCE CURVE

Three Phase Induction Motor - Squirrel Cage



Customer :

Product line : NEMA Premium Efficiency Three-Phase

Product code : 12378979

Catalog # : 00718ST3QIE213T-W22

LOAD PERFORMANCE CURVE

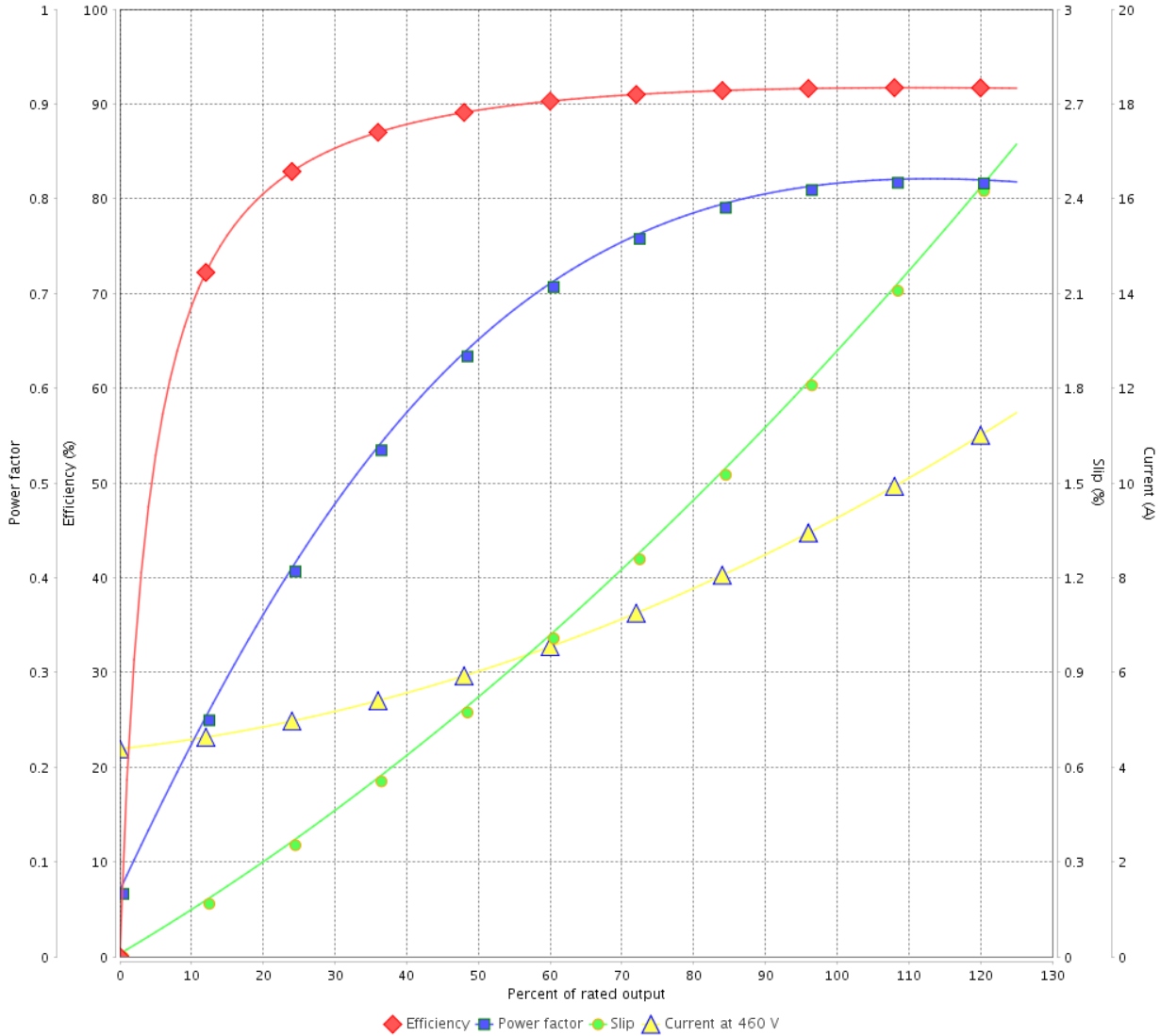

Performance : 460 V 60 Hz 4P

Rated current : 9.18 A  
 LRC : 7.1  
 Rated torque : 22.3 ft.lb  
 Locked rotor torque : 220 %  
 Breakdown torque : 310 %  
 Rated speed : 1765 rpm

Moment of inertia (J) : 1.34 sq.ft.lb  
 Duty cycle : Cont.(S1)  
 Insulation class : F  
 Service factor : 1.25  
 Temperature rise : 80 K  
 Design : B

Rev.	Changes Summary	Performed	Checked	Date
Performed by			Page 6 / 21	Revision
Checked by				
Date	13/04/2022			

# LOAD PERFORMANCE CURVE

## Three Phase Induction Motor - Squirrel Cage



Customer : \_\_\_\_\_

Product line : NEMA Premium Efficiency Three-Phase

Product code : 12378979

Catalog # : 00718ST3QIE213T-W22

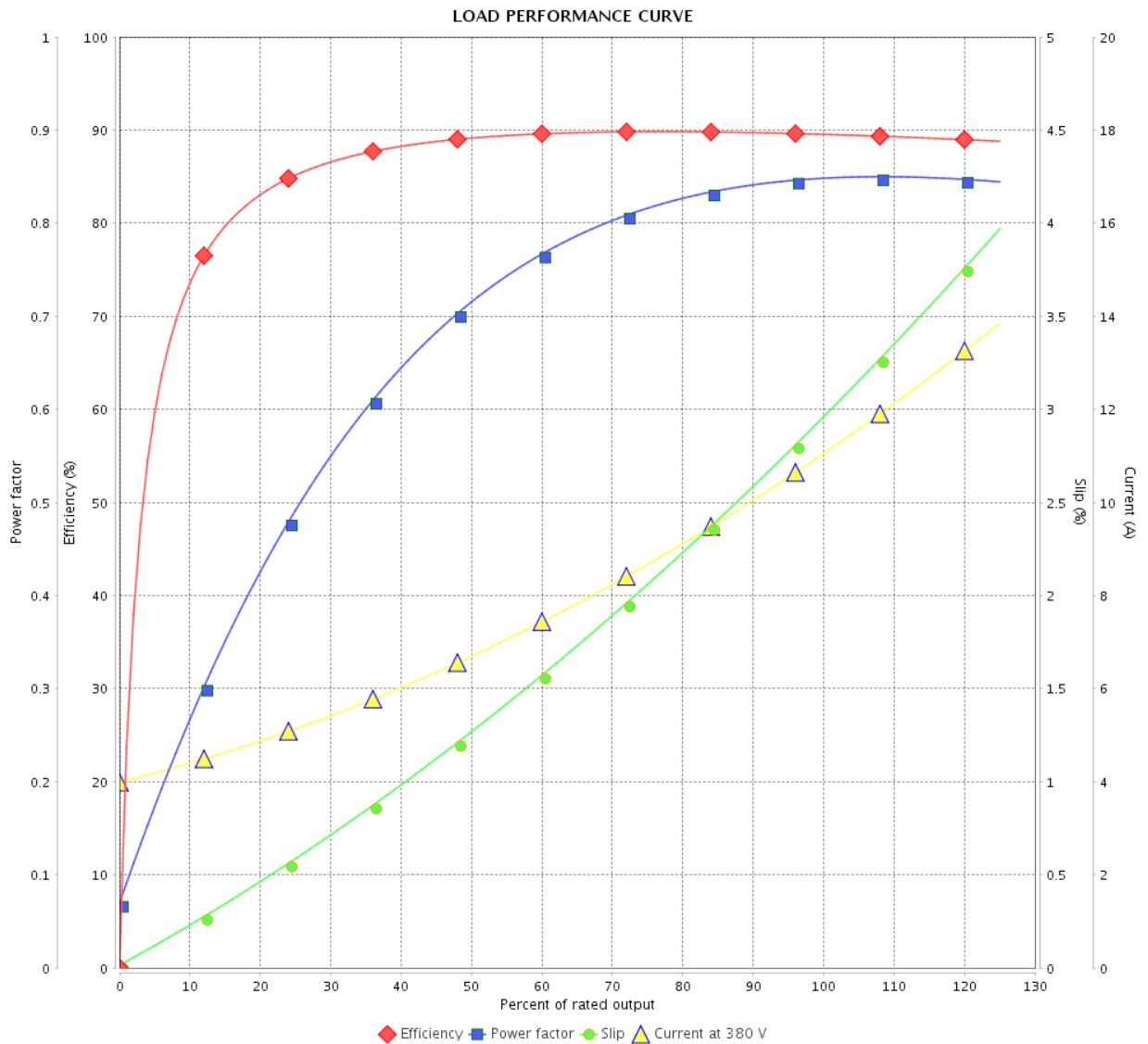

Performance : 380 V 50 Hz 4P IE3

Rated current : 11.0 A  
 LRC : 5.6  
 Rated torque : 27.1 ft.lb  
 Locked rotor torque : 170 %  
 Breakdown torque : 240 %  
 Rated speed : 1455 rpm

Moment of inertia (J) : 1.34 sq.ft.lb  
 Duty cycle : Cont.(S1)  
 Insulation class : F  
 Service factor : 1.25  
 Temperature rise : 80 K  
 Design : B

Rev.	Changes Summary	Performed	Checked	Date
Performed by		Page		Revision
Checked by		7 / 21		
Date		13/04/2022		

# LOAD PERFORMANCE CURVE

Three Phase Induction Motor - Squirrel Cage



Customer :

Product line : NEMA Premium Efficiency Three-Phase

Product code : 12378979

Catalog # : 00718ST3QIE213T-W22

LOAD PERFORMANCE CURVE

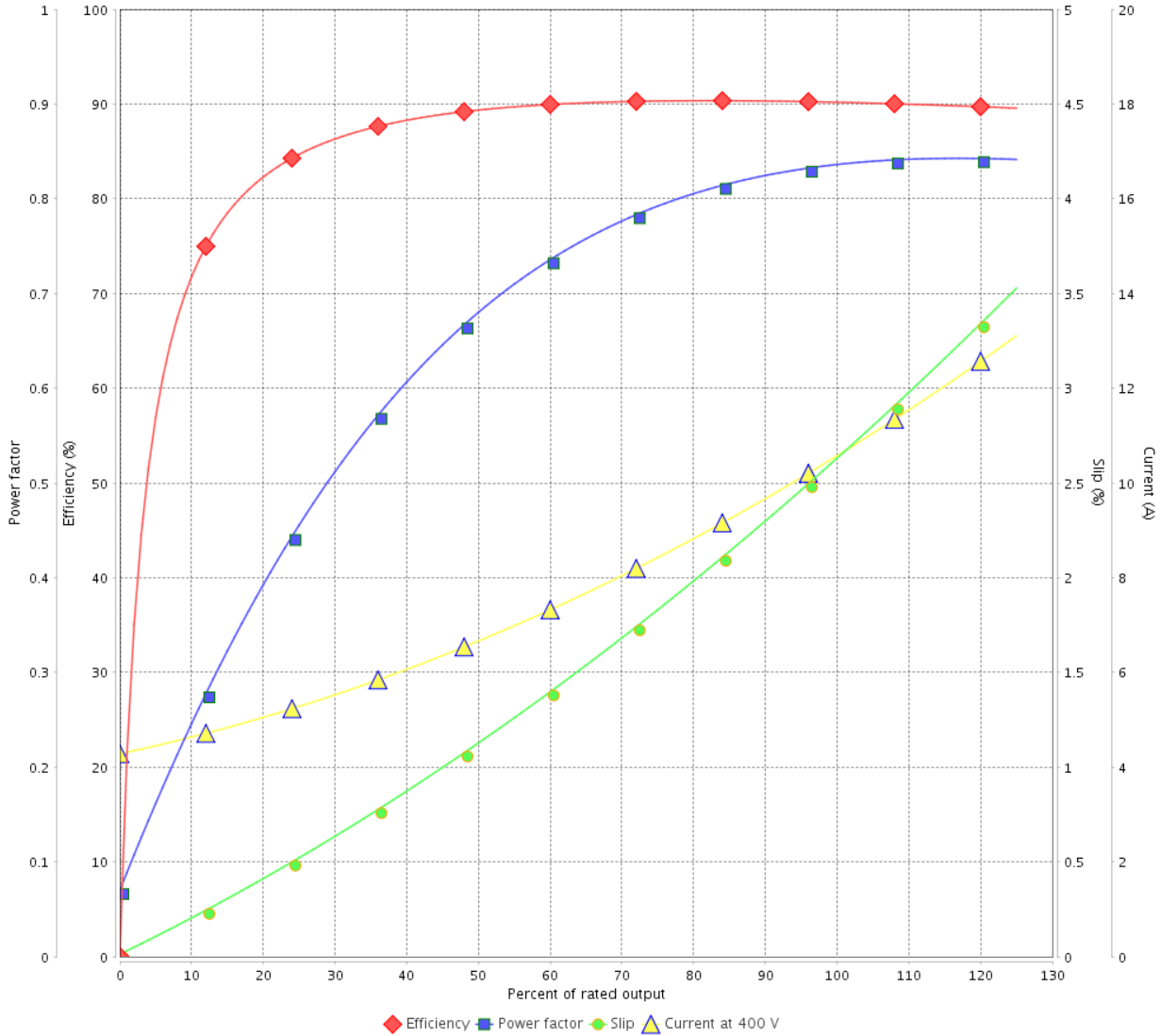

Performance : 400 V 50 Hz 4P IE3

Rated current : 10.5 A  
 LRC : 6.2  
 Rated torque : 27.0 ft.lb  
 Locked rotor torque : 190 %  
 Breakdown torque : 270 %  
 Rated speed : 1460 rpm

Moment of inertia (J) : 1.34 sq.ft.lb  
 Duty cycle : Cont.(S1)  
 Insulation class : F  
 Service factor : 1.25  
 Temperature rise : 80 K  
 Design : B

Rev.	Changes Summary	Performed	Checked	Date
Performed by			Page 8 / 21	Revision
Checked by				
Date	13/04/2022			



# LOAD PERFORMANCE CURVE

## Three Phase Induction Motor - Squirrel Cage



Customer : \_\_\_\_\_

Product line : NEMA Premium Efficiency Three-Phase

Product code : 12378979

Catalog # : 00718ST3QIE213T-W22

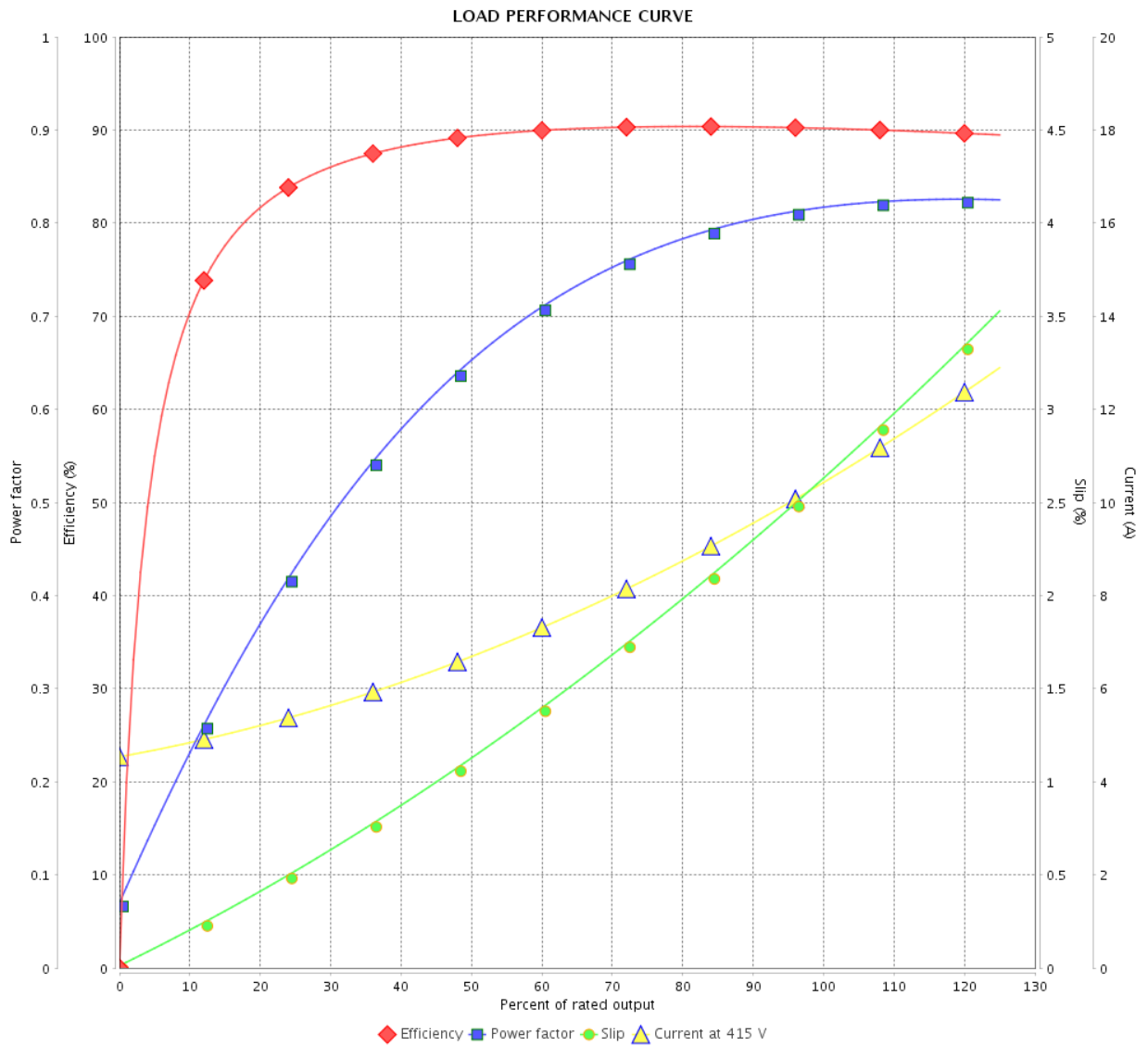

Performance : 415 V 50 Hz 4P IE3

Rated current : 10.3 A  
 LRC : 6.7  
 Rated torque : 27.0 ft.lb  
 Locked rotor torque : 210 %  
 Breakdown torque : 290 %  
 Rated speed : 1460 rpm

Moment of inertia (J) : 1.34 sq.ft.lb  
 Duty cycle : Cont.(S1)  
 Insulation class : F  
 Service factor : 1.25  
 Temperature rise : 80 K  
 Design : B

Rev.	Changes Summary	Performed	Checked	Date
Performed by		Page		Revision
Checked by		9 / 21		
Date		13/04/2022		

# THERMAL LIMIT CURVE



## Three Phase Induction Motor - Squirrel Cage

Customer :

Product line : NEMA Premium Efficiency Three-Phase  
Product code : 12378979  
Catalog # : 00718ST3QIE213T-W22

Performance : 460 V 60 Hz 4P

Rated current	: 9.18 A	Moment of inertia (J)	: 1.34 sq.ft.lb
LRC	: 7.1	Duty cycle	: Cont.(S1)
Rated torque	: 22.3 ft.lb	Insulation class	: F
Locked rotor torque	: 220 %	Service factor	: 1.25
Breakdown torque	: 310 %	Temperature rise	: 80 K
Rated speed	: 1765 rpm	Design	: B

Heating constant

Cooling constant

Rev.	Changes Summary	Performed	Checked	Date
Performed by				
Checked by			Page	Revision
Date	13/04/2022		10 / 21	

# THERMAL LIMIT CURVE

Three Phase Induction Motor - Squirrel Cage



Customer : \_\_\_\_\_

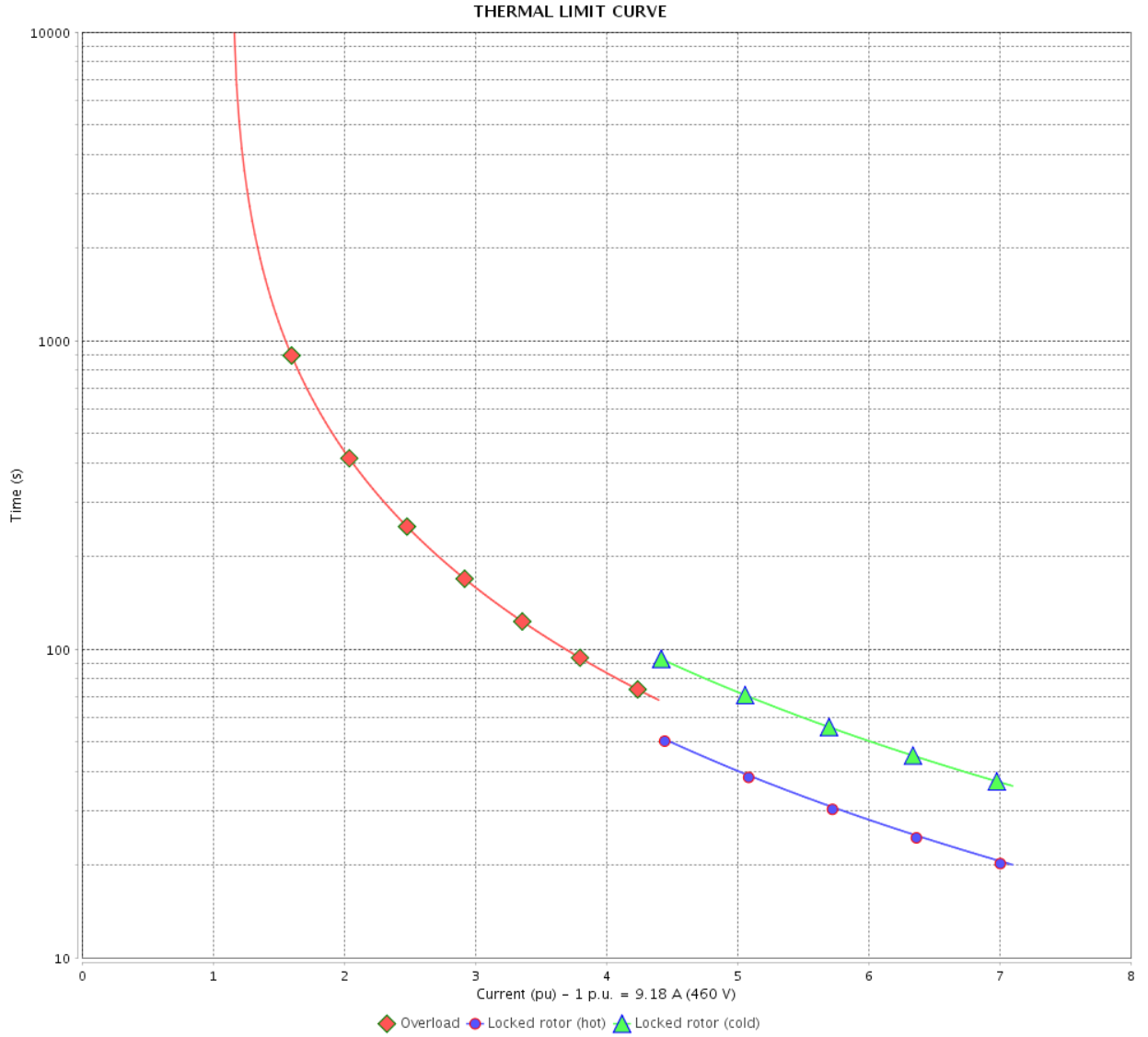

Rev.	Changes Summary	Performed	Checked	Date
Performed by		Page		Revision
Checked by		11 / 21		
Date		13/04/2022		

# THERMAL LIMIT CURVE

## Three Phase Induction Motor - Squirrel Cage



Customer :

Product line : NEMA Premium Efficiency Three-Phase  
Product code : 12378979  
Catalog # : 00718ST3QIE213T-W22

Performance : 380 V 50 Hz 4P IE3

Rated current	: 11.0 A	Moment of inertia (J)	: 1.34 sq.ft.lb
LRC	: 5.6	Duty cycle	: Cont.(S1)
Rated torque	: 27.1 ft.lb	Insulation class	: F
Locked rotor torque	: 170 %	Service factor	: 1.25
Breakdown torque	: 240 %	Temperature rise	: 80 K
Rated speed	: 1455 rpm	Design	: B

Heating constant

Cooling constant

Rev.	Changes Summary	Performed	Checked	Date
Performed by				
Checked by			Page	Revision
Date	13/04/2022		12 / 21	

# THERMAL LIMIT CURVE

Three Phase Induction Motor - Squirrel Cage



Customer : \_\_\_\_\_

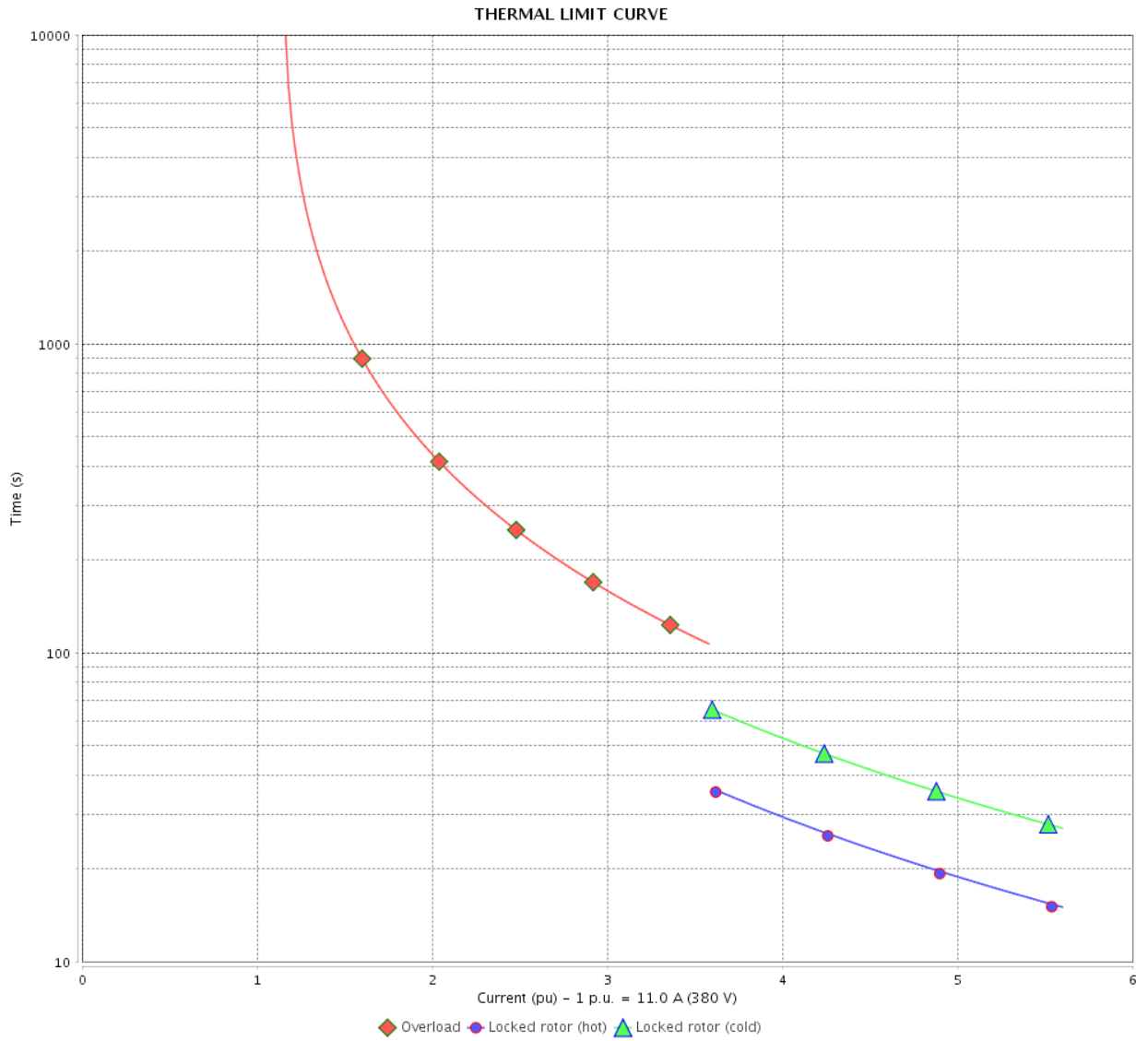

Rev.	Changes Summary	Performed	Checked	Date
Performed by		Page		Revision
Checked by		13 / 21		
Date	13/04/2022			

# THERMAL LIMIT CURVE

## Three Phase Induction Motor - Squirrel Cage



Customer :

Product line : NEMA Premium Efficiency Three-Phase

Product code : 12378979

Catalog # : 00718ST3QIE213T-W22

Performance : 400 V 50 Hz 4P IE3

Rated current	: 10.5 A	Moment of inertia (J)	: 1.34 sq.ft.lb
LRC	: 6.2	Duty cycle	: Cont.(S1)
Rated torque	: 27.0 ft.lb	Insulation class	: F
Locked rotor torque	: 190 %	Service factor	: 1.25
Breakdown torque	: 270 %	Temperature rise	: 80 K
Rated speed	: 1460 rpm	Design	: B

Heating constant

Cooling constant

Rev.	Changes Summary	Performed	Checked	Date
Performed by				
Checked by			Page	Revision
Date	13/04/2022		14 / 21	

# THERMAL LIMIT CURVE

Three Phase Induction Motor - Squirrel Cage



Customer : \_\_\_\_\_

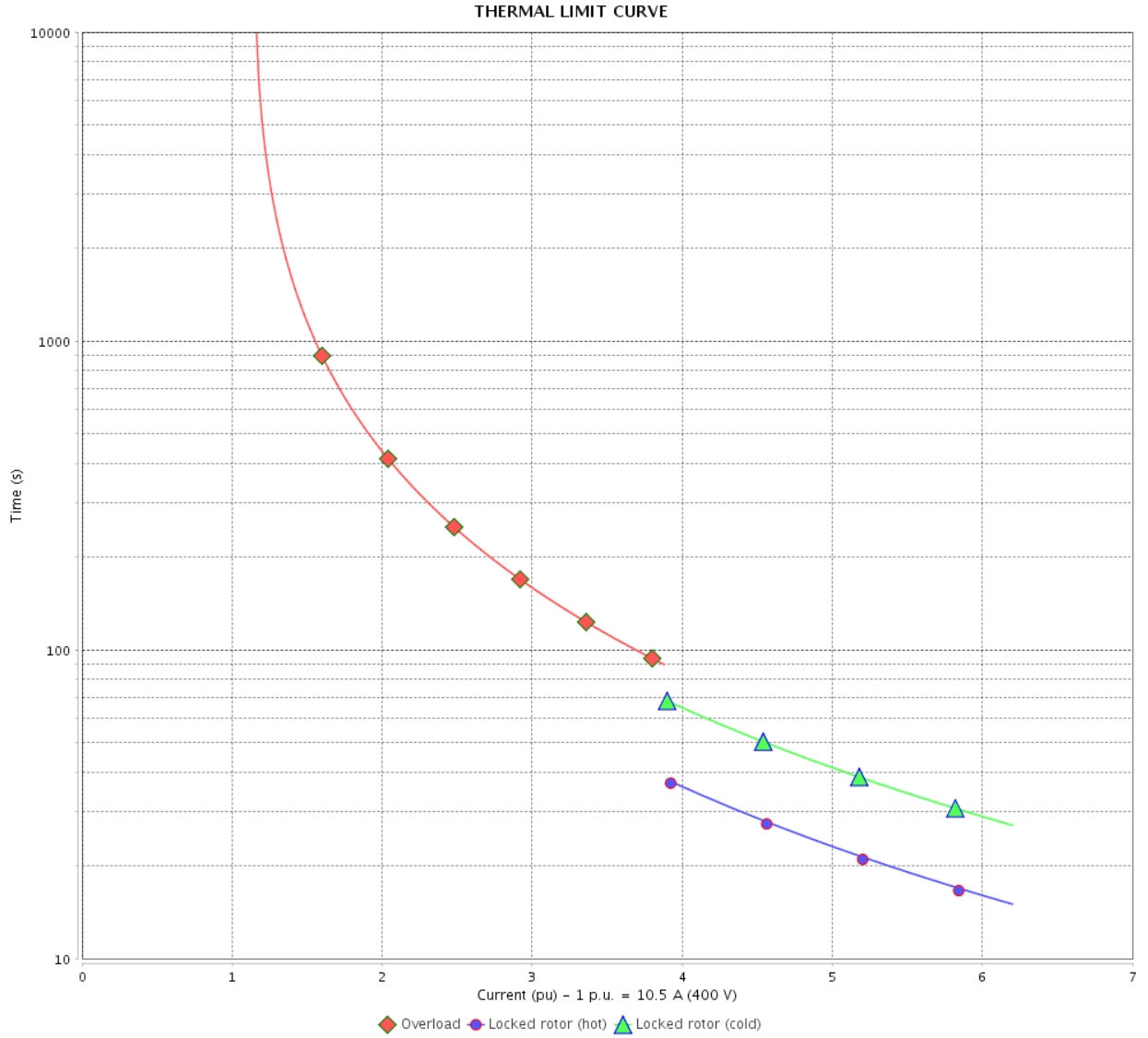

Rev.	Changes Summary	Performed	Checked	Date
Performed by		Page		Revision
Checked by		15 / 21		
Date		13/04/2022		

# THERMAL LIMIT CURVE



## Three Phase Induction Motor - Squirrel Cage

Customer :

Product line : NEMA Premium Efficiency Three-Phase  
Product code : 12378979  
Catalog # : 00718ST3QIE213T-W22

Performance : 415 V 50 Hz 4P IE3

Rated current	: 10.3 A	Moment of inertia (J)	: 1.34 sq.ft.lb
LRC	: 6.7	Duty cycle	: Cont.(S1)
Rated torque	: 27.0 ft.lb	Insulation class	: F
Locked rotor torque	: 210 %	Service factor	: 1.25
Breakdown torque	: 290 %	Temperature rise	: 80 K
Rated speed	: 1460 rpm	Design	: B

Heating constant

Cooling constant

Rev.	Changes Summary	Performed	Checked	Date
Performed by				
Checked by			Page	Revision
Date	13/04/2022		16 / 21	



# THERMAL LIMIT CURVE

Three Phase Induction Motor - Squirrel Cage



Customer : \_\_\_\_\_

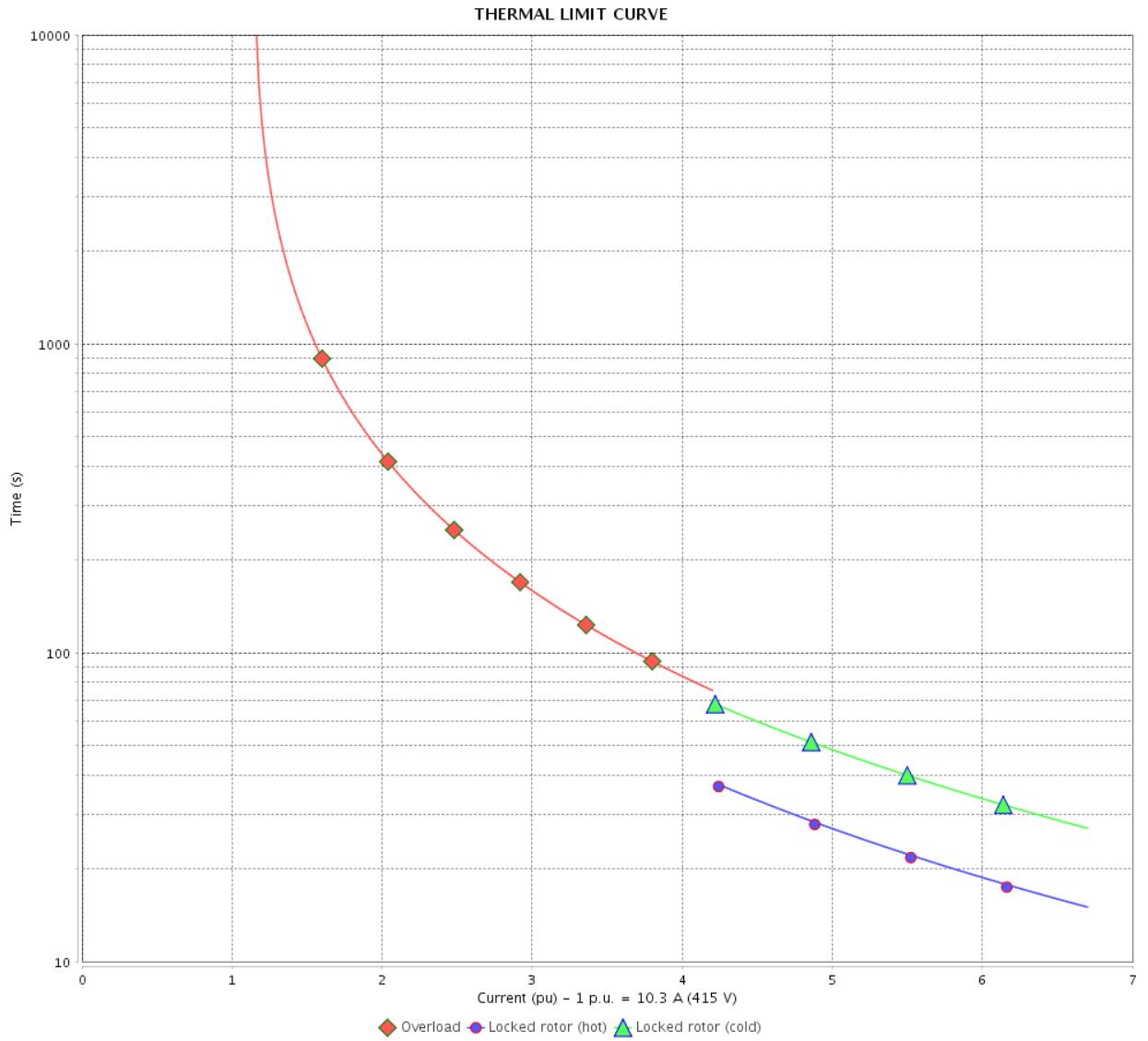

Rev.	Changes Summary	Performed	Checked	Date
Performed by		Page		Revision
Checked by		17 / 21		
Date	13/04/2022			

# VFD OPERATION CURVE

Three Phase Induction Motor - Squirrel Cage



Customer :

Product line : NEMA Premium Efficiency Three-Phase

Product code : 12378979

Catalog # : 00718ST3QIE213T-W22

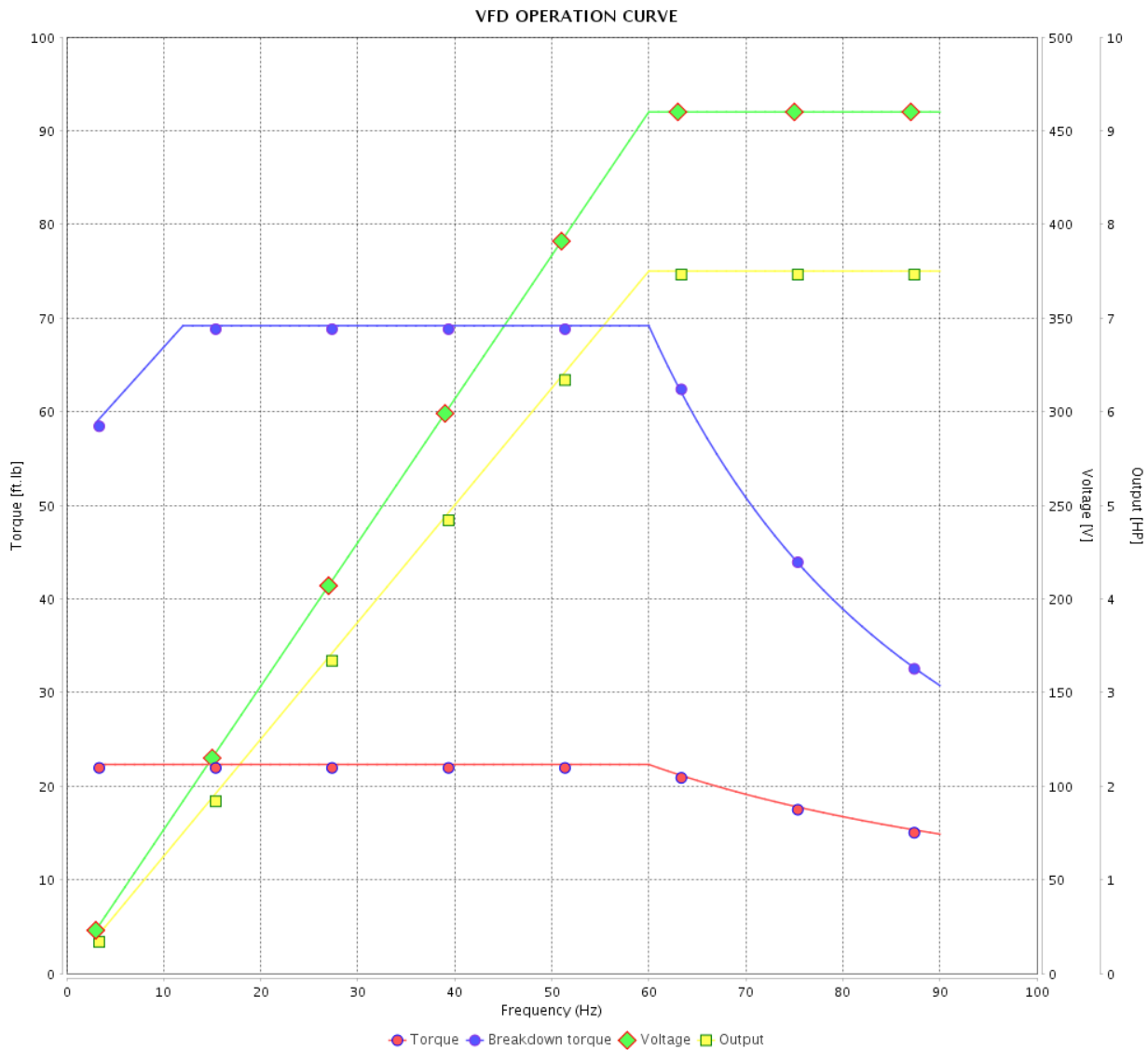

Performance : 460 V 60 Hz 4P

Rated current : 9.18 A  
 LRC : 7.1  
 Rated torque : 22.3 ft.lb  
 Locked rotor torque : 220 %  
 Breakdown torque : 310 %  
 Rated speed : 1765 rpm

Moment of inertia (J) : 1.34 sq.ft.lb  
 Duty cycle : Cont.(S1)  
 Insulation class : F  
 Service factor : 1.25  
 Temperature rise : 80 K  
 Design : B

Rev.	Changes Summary	Performed	Checked	Date
Performed by			Page 18 / 21	Revision
Checked by				
Date	13/04/2022			

# VFD OPERATION CURVE

Three Phase Induction Motor - Squirrel Cage



Customer :

Product line : NEMA Premium Efficiency Three-Phase

Product code : 12378979

Catalog # : 00718ST3QIE213T-W22

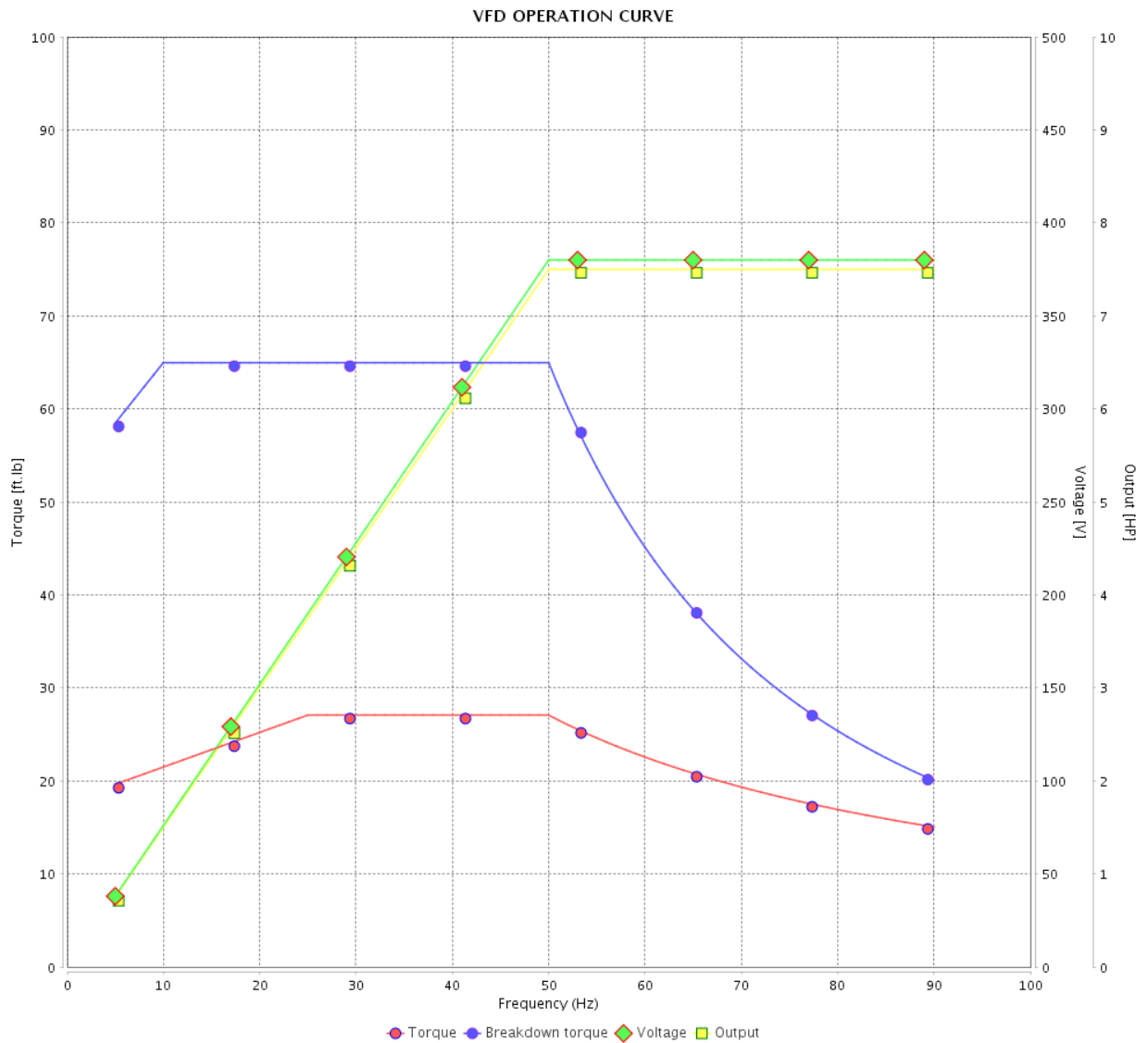

Performance : 380 V 50 Hz 4P IE3

Rated current : 11.0 A  
 LRC : 5.6  
 Rated torque : 27.1 ft.lb  
 Locked rotor torque : 170 %  
 Breakdown torque : 240 %  
 Rated speed : 1455 rpm

Moment of inertia (J) : 1.34 sq.ft.lb  
 Duty cycle : Cont.(S1)  
 Insulation class : F  
 Service factor : 1.25  
 Temperature rise : 80 K  
 Design : B

Rev.	Changes Summary	Performed	Checked	Date
Performed by			Page 19 / 21	Revision
Checked by				
Date	13/04/2022			

# VFD OPERATION CURVE

Three Phase Induction Motor - Squirrel Cage



Customer : \_\_\_\_\_

Product line : NEMA Premium Efficiency Three-Phase

Product code : 12378979

Catalog # : 00718ST3QIE213T-W22

VFD OPERATION CURVE

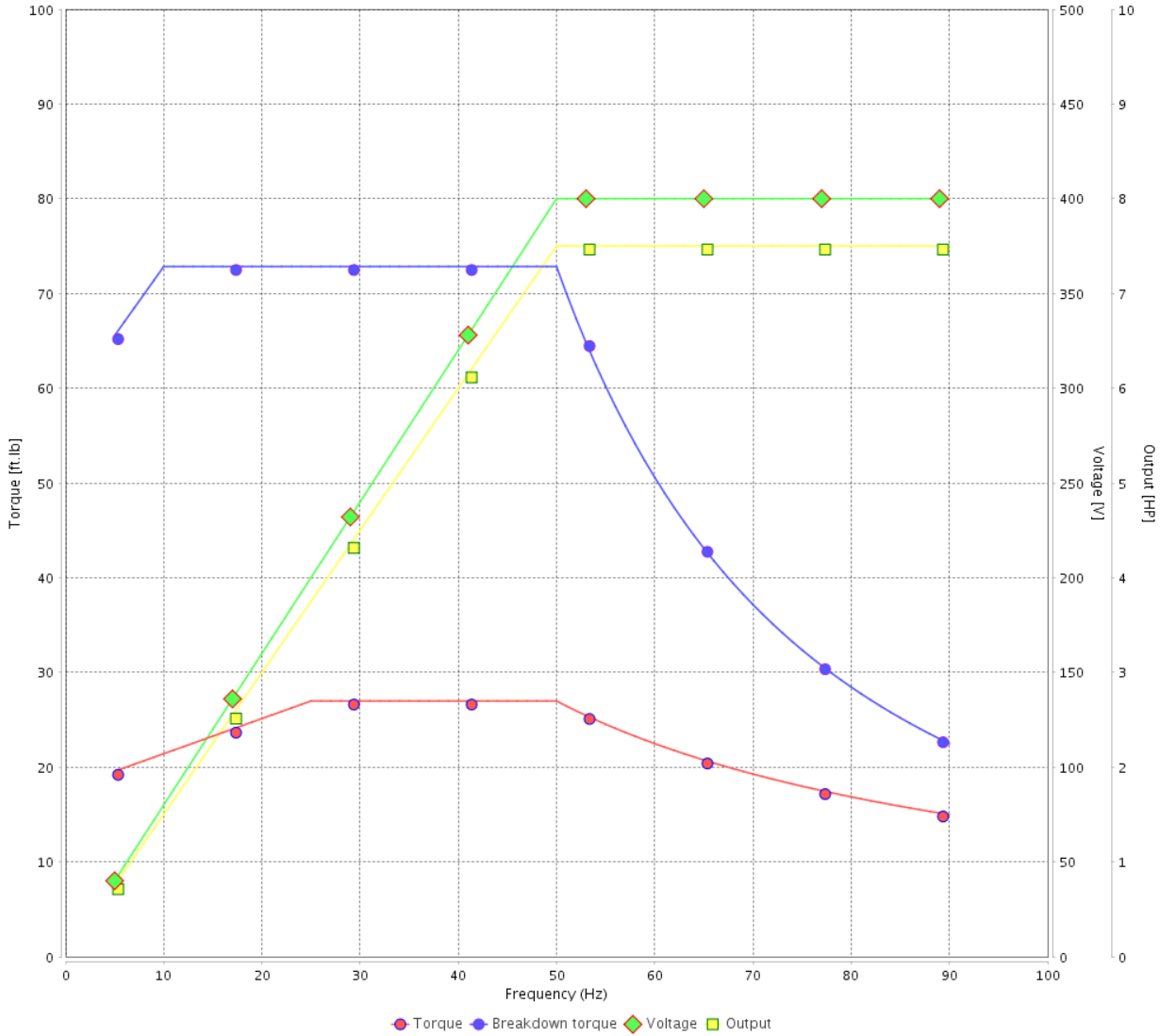

Performance : 400 V 50 Hz 4P IE3

Rated current : 10.5 A  
 LRC : 6.2  
 Rated torque : 27.0 ft.lb  
 Locked rotor torque : 190 %  
 Breakdown torque : 270 %  
 Rated speed : 1460 rpm

Moment of inertia (J) : 1.34 sq.ft.lb  
 Duty cycle : Cont.(S1)  
 Insulation class : F  
 Service factor : 1.25  
 Temperature rise : 80 K  
 Design : B

Rev.	Changes Summary	Performed	Checked	Date
Performed by			Page 20 / 21	Revision
Checked by				
Date	13/04/2022			

# VFD OPERATION CURVE

Three Phase Induction Motor - Squirrel Cage



Customer :

Product line : NEMA Premium Efficiency Three-Phase

Product code : 12378979

Catalog # : 00718ST3QIE213T-W22

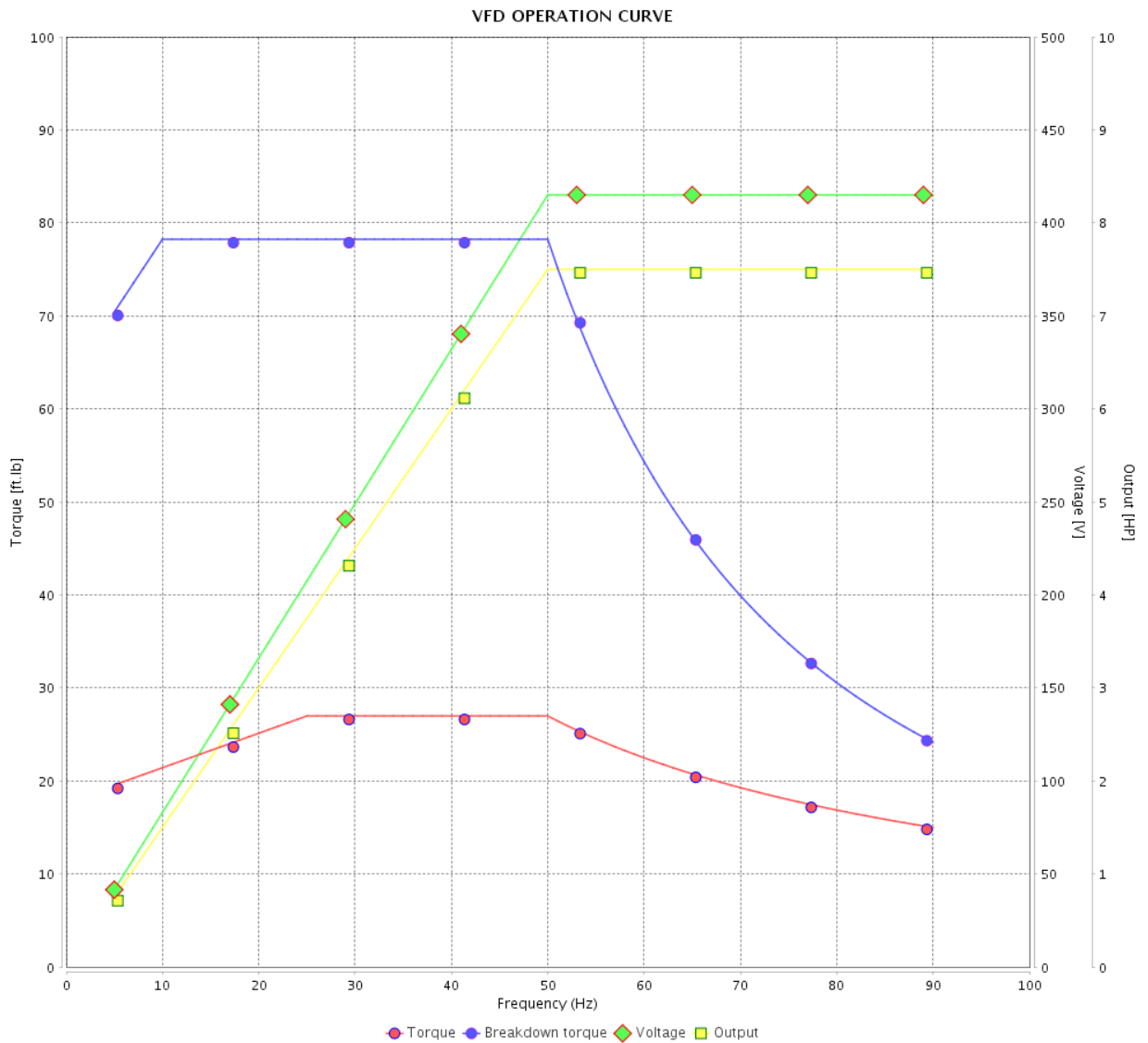

Performance : 415 V 50 Hz 4P IE3

Rated current : 10.3 A  
 LRC : 6.7  
 Rated torque : 27.0 ft.lb  
 Locked rotor torque : 210 %  
 Breakdown torque : 290 %  
 Rated speed : 1460 rpm

Moment of inertia (J) : 1.34 sq.ft.lb  
 Duty cycle : Cont.(S1)  
 Insulation class : F  
 Service factor : 1.25  
 Temperature rise : 80 K  
 Design : B

Rev.	Changes Summary	Performed	Checked	Date
Performed by				Page 21 / 21
Checked by				
Date	13/04/2022			

1 2 3 4 5 6

A

B

C

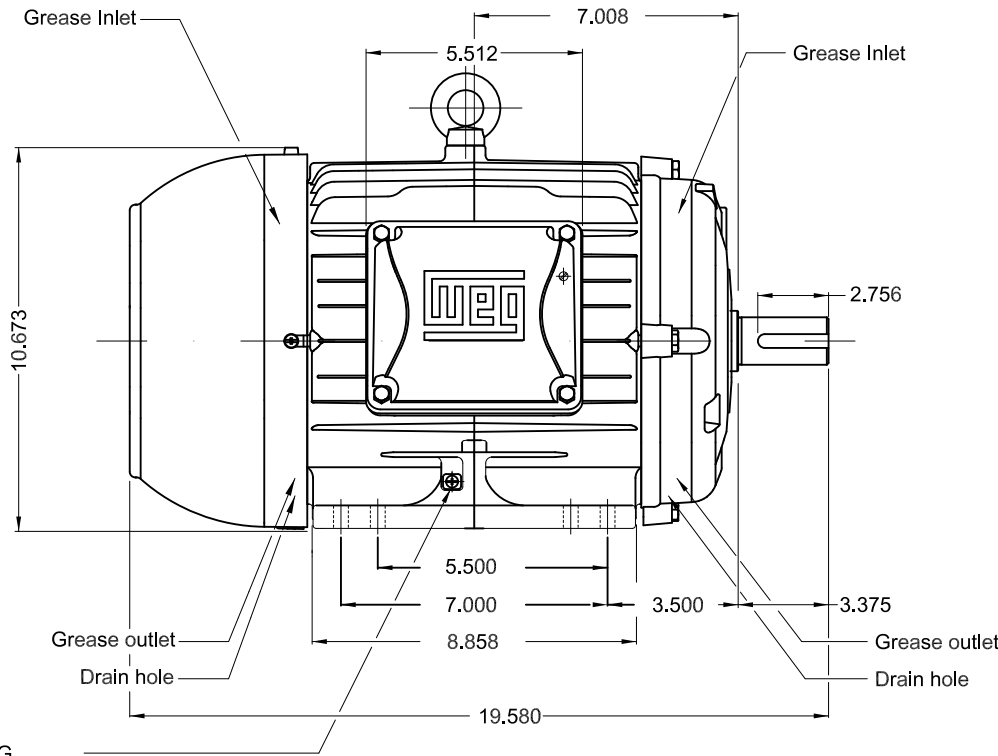
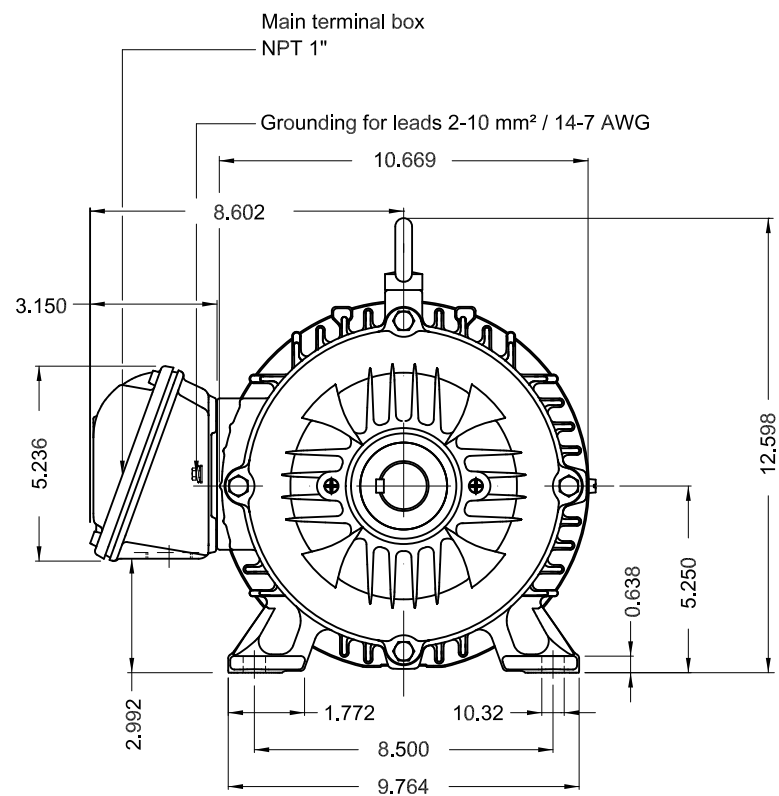

Grounding for leads 2-10 mm² / 14-7 AWG

D

E

Color RAL 5009  
 Painting plan 202E  
 Mounting B3R(D)

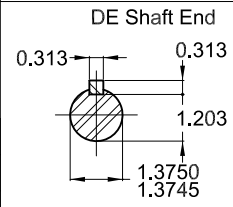

7.5 HP 04 Poles 60 Hz A

ECM	LOC	SUMMARY OF MODIFICATIONS	EXECUTED	CHECKED	RELEASED	DATE	VER
EXECUTED	PIRWBUSER	THREE PH. MOTOR IEEE 841 W22 PREM. EFF.					
CHECKED		FRAME 213/5T IP55 TEFC					
RELEASED							
REL DT.	WMO	Jaragua do Sul	Product Engineering	SHEET	1 / 1		

PREVIEW  
 WDD



MADE IN BRAZIL  
12378979



**NEMA**  
Premium



Class I, Div 2, Gr A, B, C and D - T3  
Class I, Zone 2, IIC - T3  
Class II, Div 2, Gr F and G - T4  
For use on PWM: Gr. A, B, C, D and F,  
VT 1000:1, CT 20:1, 1.00SF - T3A

MODEL 00718ST3QIE213T-W22

Inverter Duty Motor  
Severe Duty

**IEEE**  
841-2009



FOR SAFE AREA  
Mod. TE1BFOXON  
CC029A

PH3 60Hz Fr. 213/5T 1000m.a.s.l. IP55 TEFC 177lb

V 460

A 9.18

HP 7.5

kW 5.5

SF 1.25

SFA 11.5

RPM 1765

PF 0.82

AMB 40°C

INS cl. F DT80K

NEMA NOM EFF 91.7%

DUTY CONT.

DES B Code H

GUARANT. EFF 90.2%

