

DATA SHEET

Three Phase Induction Motor - Squirrel Cage



Customer								
Product line	: NEMA Premium Efficiency Three-Phase	Product code	: 11431640					
		Catalog #	: 01018ST3QIE215T-W22					
Frame	: 213/5T	Cooling method	: IC411 - TEFC					
Insulation class	: F	Mounting	: F-1					
Duty cycle	: Cont.(S1)	Rotation ¹	: Both (CW and CCW)					
Ambient temperature	: -20°C to +40°C	Starting method	: Direct On Line					
Altitude	: 1000 m.a.s.l.	Approx. weight ²	: 192 lb					
Protection degree	: IP55	Moment of inertia (J)	: 1.51 sq.ft.lb					
Design	: B							
Output [HP]	10	7.5	7.5	7.5	10	10	10	
Poles	4	4	4	4	4	4	4	
Frequency [Hz]	60	50	50	50	50	50	50	
Rated voltage [V]	460	380	400	415	380	400	415	
Rated current [A]	12.4	11.2	11.0	10.9	15.0	14.2	13.8	
L. R. Amperes [A]	79.4	75.0	78.1	81.7	76.5	79.5	82.8	
LRC [A]	6.4x(Code H)	6.7x(Code H)	7.1x(Code J)	7.5x(Code J)	5.1x(Code F)	5.6x(Code F)	6.0x(Code G)	
No load current [A]	5.65	5.60	6.00	6.35	5.60	6.00	6.35	
Rated speed [RPM]	1765	1465	1470	1470	1450	1455	1460	
Slip [%]	1.94	2.33	2.00	2.00	3.33	3.00	2.67	
Rated torque [ft.lb]	29.8	26.9	26.8	26.8	36.2	36.1	36.0	
Locked rotor torque [%]	200	200	240	260	150	180	190	
Breakdown torque [%]	295	300	340	360	220	250	270	
Service factor	1.25	1.15	1.15	1.15	1.15	1.15	1.15	
Temperature rise	80 K	80 K	80 K	80 K	80 K	80 K	80 K	
Locked rotor time	30s (cold) 17s (hot)	25s (cold) 14s (hot)	25s (cold) 14s (hot)	25s (cold) 14s (hot)	25s (cold) 14s (hot)	25s (cold) 14s (hot)	25s (cold) 14s (hot)	
Noise level ²	58.0 dB(A)	56.0 dB(A)	56.0 dB(A)	56.0 dB(A)	56.0 dB(A)	56.0 dB(A)	56.0 dB(A)	
Efficiency (%)	25%	90.8	90.0	88.8	88.0	91.6	90.7	90.1
	50%	91.0	90.0	89.2	88.7	90.3	90.3	90.3
	75%	91.7	90.0	89.9	89.8	90.2	90.2	90.2
	100%	91.7	89.8	90.1	90.3	88.5	89.5	90.2
Power Factor	25%	0.40	0.37	0.34	0.32	0.46	0.43	0.40
	50%	0.66	0.62	0.58	0.55	0.73	0.69	0.66
	75%	0.77	0.76	0.73	0.70	0.82	0.80	0.78
	100%	0.83	0.83	0.80	0.78	0.86	0.85	0.84
Bearing type	: Drive end : 6308 C3	Non drive end : 6207 C3	Foundation loads					
Sealing	: Inpro/Seal	Inpro/Seal	Max. traction	: 452 lb				
Lubrication interval	: 20000 h	20000 h	Max. compression	: 644 lb				
Lubricant amount	: 11 g	7 g						
Lubricant type	: Mobil Polyrex EM							
Notes								
This revision replaces and cancel the previous one, which must be eliminated. (1) Looking the motor from the shaft end. (2) Measured at 1m and with tolerance of +3dB(A). (3) Approximate weight subject to changes after manufacturing process. (4) At 100% of full load.				These are average values based on tests with sinusoidal power supply, subject to the tolerances stipulated in NEMA MG-1.				
Rev.	Changes Summary			Performed	Checked	Date		
Performed by								
Checked by					Page	Revision		
Date	12/04/2022				1 / 36			

TORQUE AND CURRENT VS SPEED CURVE

Three Phase Induction Motor - Squirrel Cage



Customer :

Product line : NEMA Premium Efficiency Three-Phase

Product code : 11431640

Catalog # : 01018ST3QIE215T-W22

TORQUE AND CURRENT VS SPEED CURVE

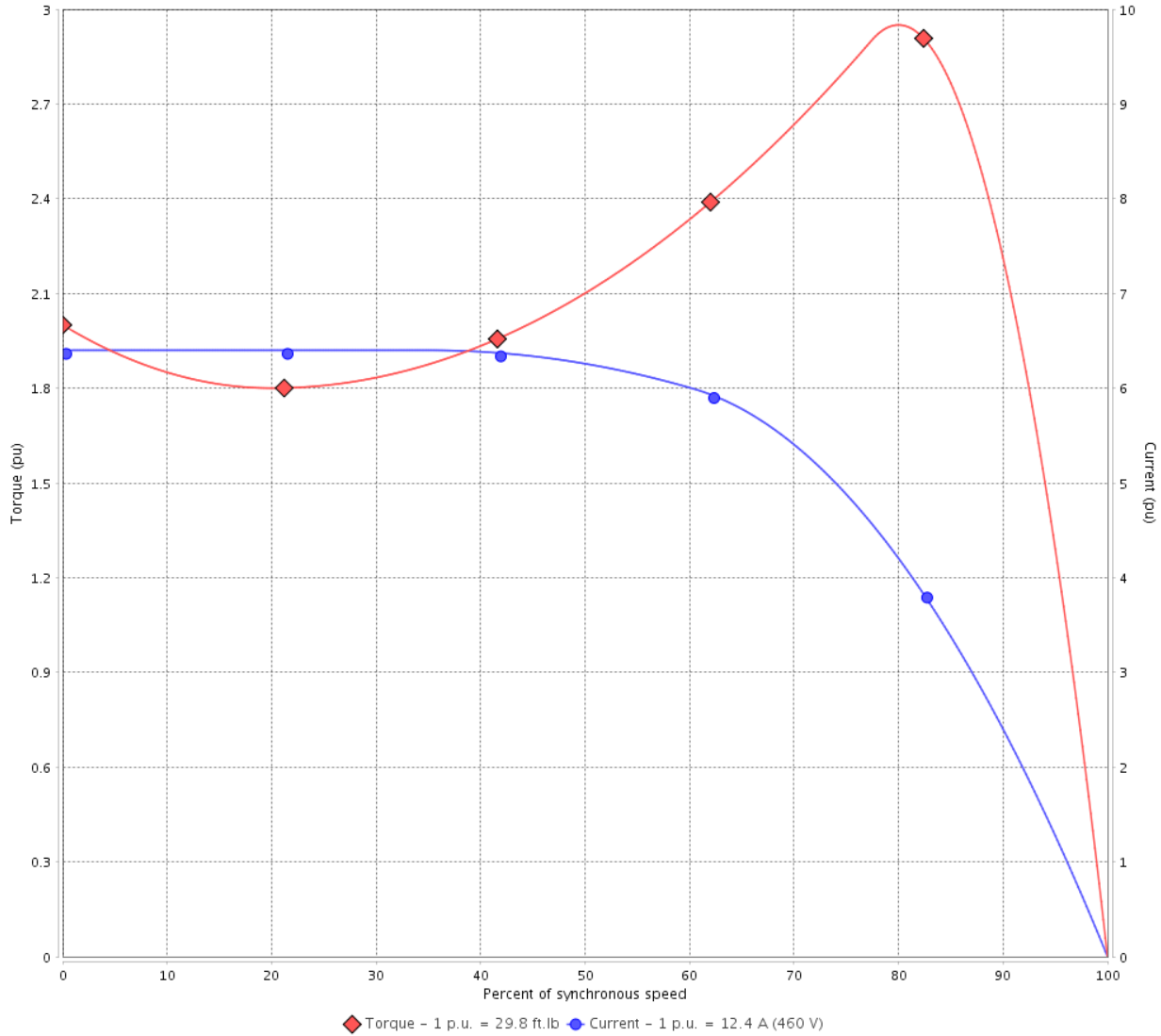

Performance : 460 V 60 Hz 4P

Rated current	: 12.4 A	Moment of inertia (J)	: 1.51 sq.ft.lb
LRC	: 6.4	Duty cycle	: Cont.(S1)
Rated torque	: 29.8 ft.lb	Insulation class	: F
Locked rotor torque	: 200 %	Service factor	: 1.25
Breakdown torque	: 295 %	Temperature rise	: 80 K
Rated speed	: 1765 rpm	Design	: B

Locked rotor time : 30s (cold) 17s (hot)

Rev.	Changes Summary	Performed	Checked	Date
Performed by			Page 2 / 36	Revision
Checked by				
Date	12/04/2022			

TORQUE AND CURRENT VS SPEED CURVE



Three Phase Induction Motor - Squirrel Cage

Customer :

Product line : NEMA Premium Efficiency Three-Phase

Product code : 11431640

Catalog # : 01018ST3QIE215T-W22

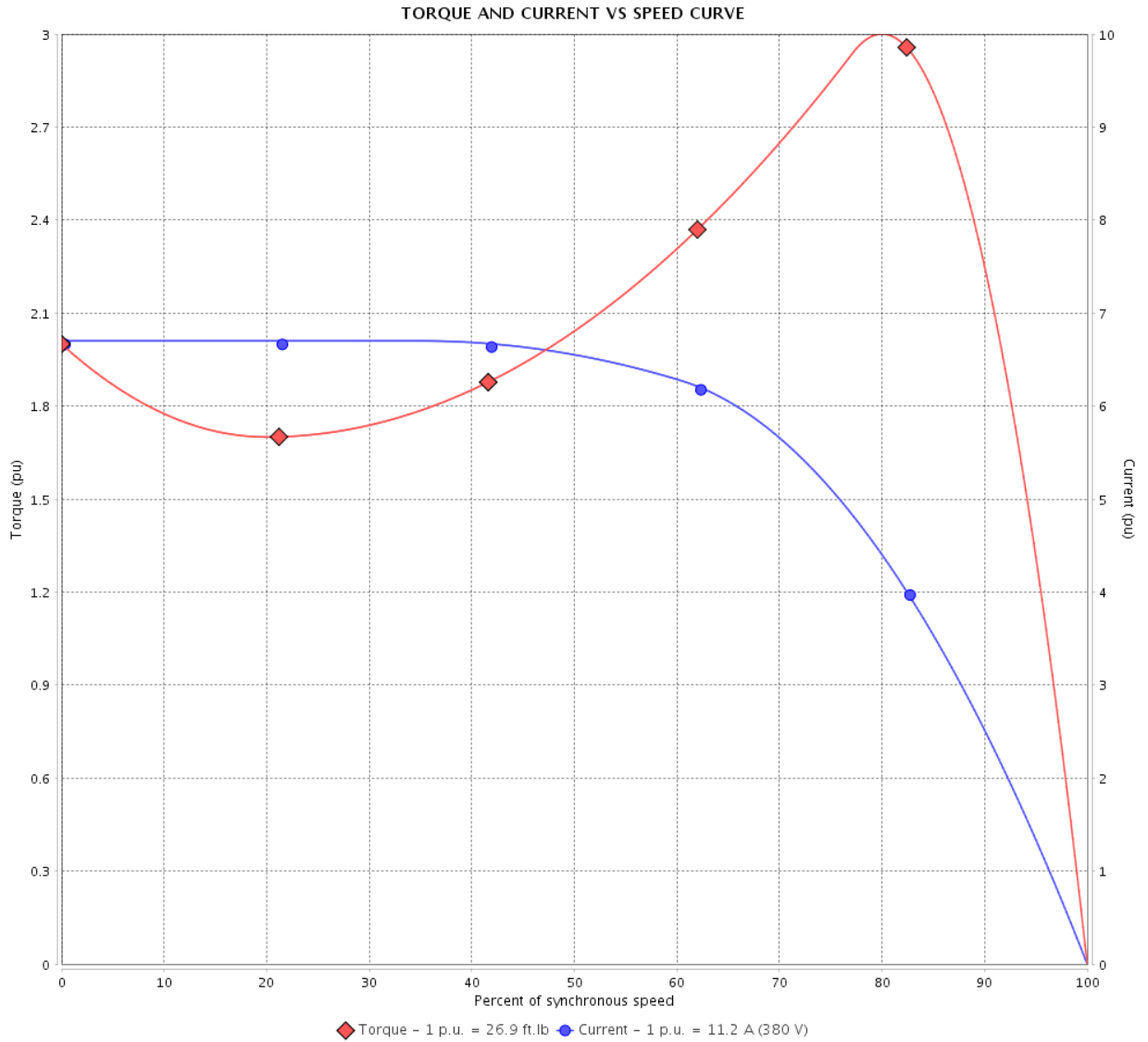

Performance : 380 V 50 Hz 4P IE3

Rated current	: 11.2 A	Moment of inertia (J)	: 1.51 sq.ft.lb
LRC	: 6.7	Duty cycle	: Cont.(S1)
Rated torque	: 26.9 ft.lb	Insulation class	: F
Locked rotor torque	: 200 %	Service factor	: 1.15
Breakdown torque	: 300 %	Temperature rise	: 80 K
Rated speed	: 1465 rpm	Design	: B

Locked rotor time : 25s (cold) 14s (hot)

Rev.	Changes Summary	Performed	Checked	Date
Performed by		Page		Revision
Checked by		3 / 36		
Date	12/04/2022			

TORQUE AND CURRENT VS SPEED CURVE

Three Phase Induction Motor - Squirrel Cage



Customer :

Product line : NEMA Premium Efficiency Three-Phase

Product code : 11431640

Catalog # : 01018ST3QIE215T-W22

TORQUE AND CURRENT VS SPEED CURVE

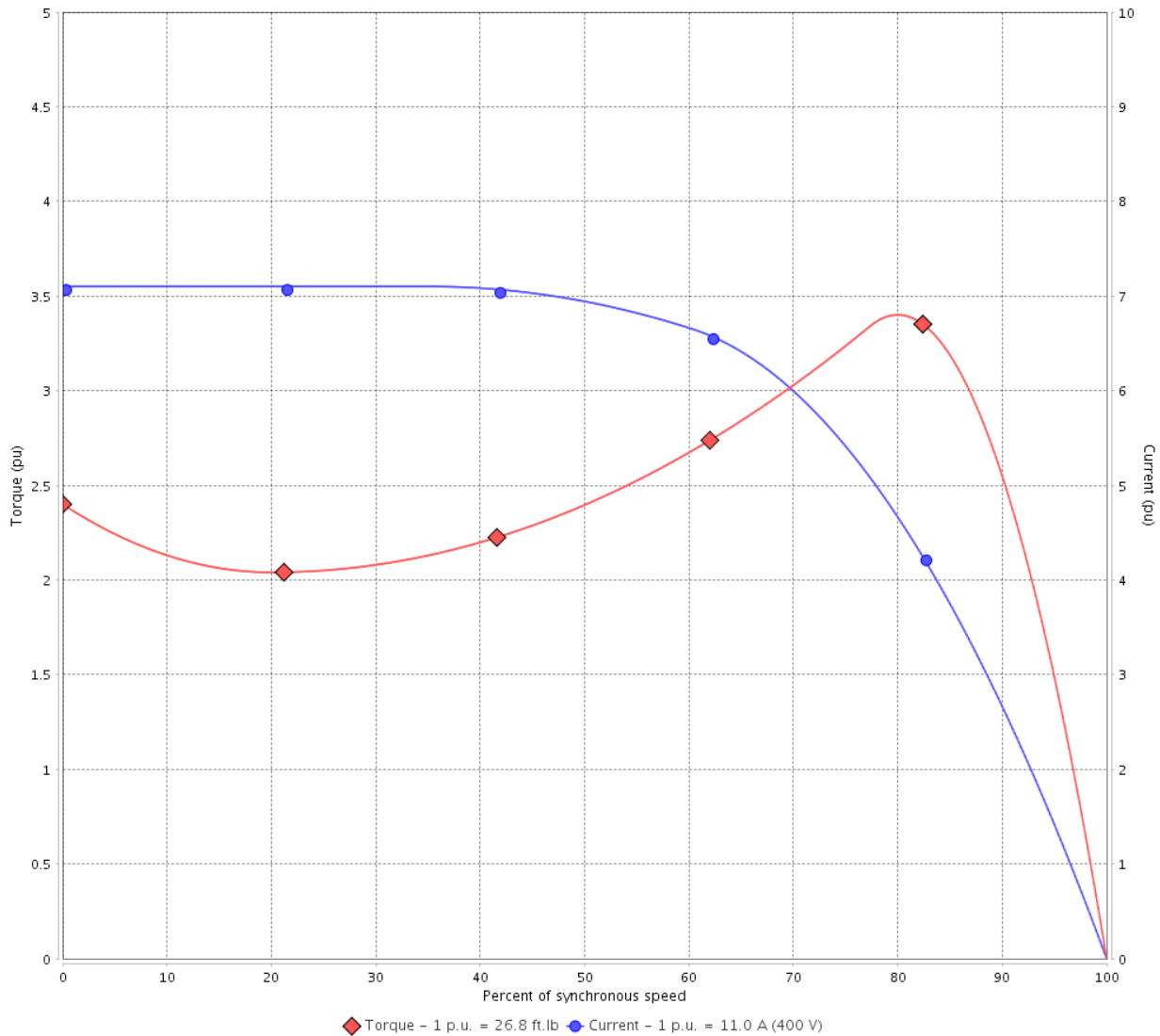

Performance : 400 V 50 Hz 4P IE3

Rated current	: 11.0 A	Moment of inertia (J)	: 1.51 sq.ft.lb
LRC	: 7.1	Duty cycle	: Cont.(S1)
Rated torque	: 26.8 ft.lb	Insulation class	: F
Locked rotor torque	: 240 %	Service factor	: 1.15
Breakdown torque	: 340 %	Temperature rise	: 80 K
Rated speed	: 1470 rpm	Design	: B

Locked rotor time : 25s (cold) 14s (hot)

Rev.	Changes Summary	Performed	Checked	Date
Performed by			Page 4 / 36	Revision
Checked by				
Date	12/04/2022			

TORQUE AND CURRENT VS SPEED CURVE



Three Phase Induction Motor - Squirrel Cage

Customer :

Product line : NEMA Premium Efficiency Three-Phase

Product code : 11431640

Catalog # : 01018ST3QIE215T-W22

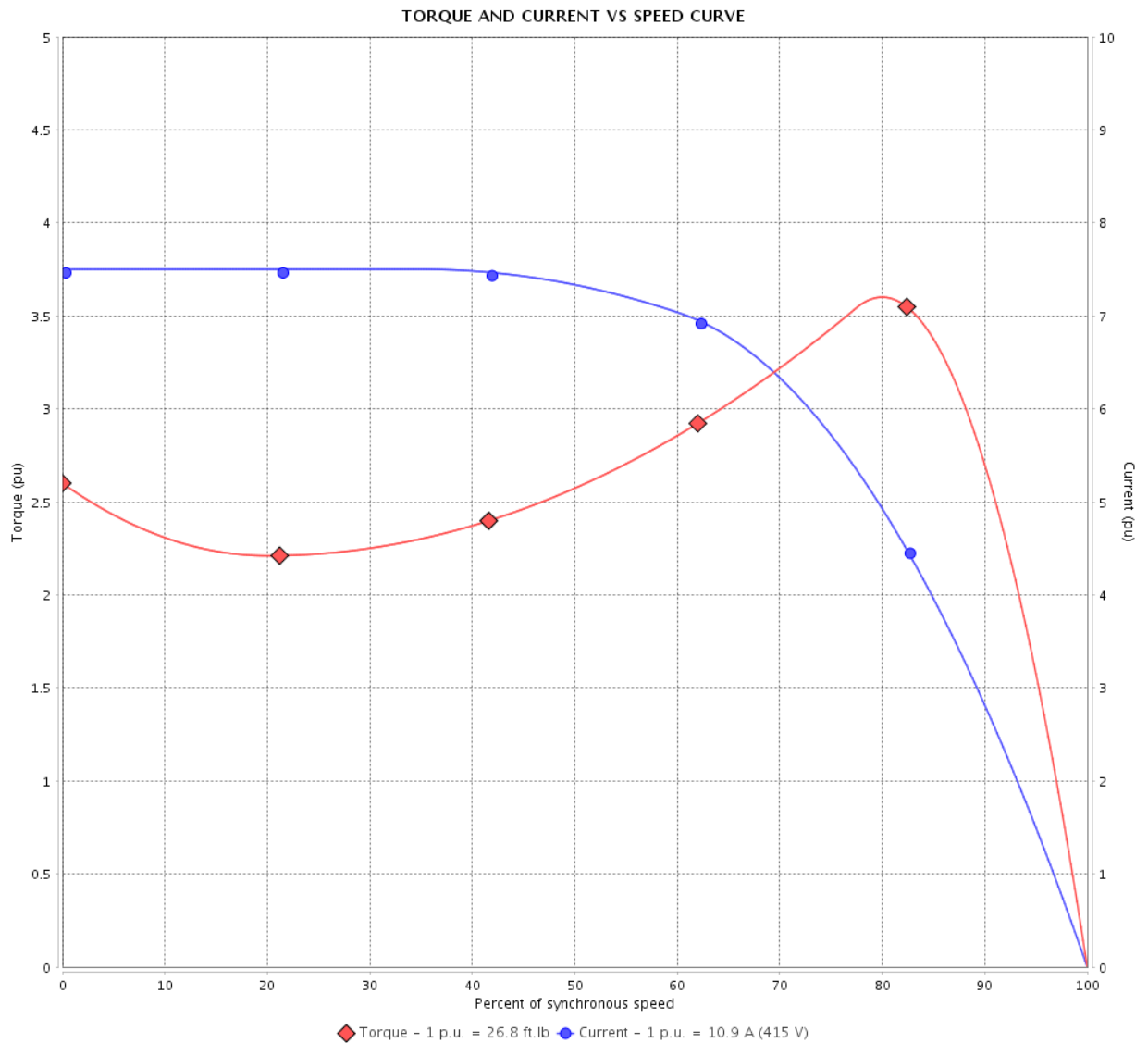

Performance : 415 V 50 Hz 4P IE3

Rated current	: 10.9 A	Moment of inertia (J)	: 1.51 sq.ft.lb
LRC	: 7.5	Duty cycle	: Cont.(S1)
Rated torque	: 26.8 ft.lb	Insulation class	: F
Locked rotor torque	: 260 %	Service factor	: 1.15
Breakdown torque	: 360 %	Temperature rise	: 80 K
Rated speed	: 1470 rpm	Design	: B

Locked rotor time : 25s (cold) 14s (hot)

Rev.	Changes Summary	Performed	Checked	Date
Performed by			Page 5 / 36	Revision
Checked by				
Date	12/04/2022			

TORQUE AND CURRENT VS SPEED CURVE

Three Phase Induction Motor - Squirrel Cage



Customer :

Product line : NEMA Premium Efficiency Three-Phase

Product code : 11431640

Catalog # : 01018ST3QIE215T-W22

TORQUE AND CURRENT VS SPEED CURVE

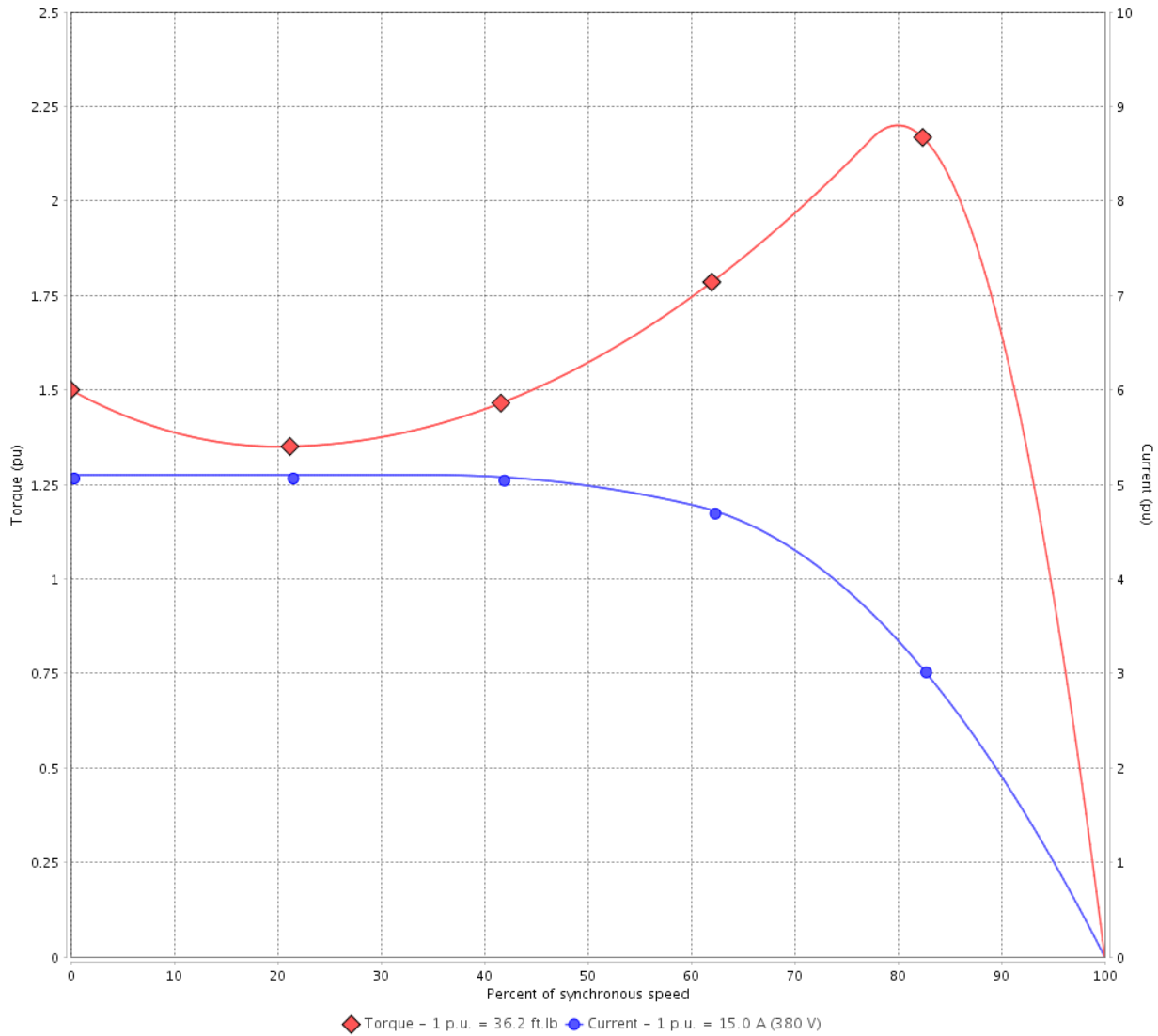

Performance : 380 V 50 Hz 4P IE1

Rated current	: 15.0 A	Moment of inertia (J)	: 1.51 sq.ft.lb
LRC	: 5.1	Duty cycle	: Cont.(S1)
Rated torque	: 36.2 ft.lb	Insulation class	: F
Locked rotor torque	: 150 %	Service factor	: 1.15
Breakdown torque	: 220 %	Temperature rise	: 80 K
Rated speed	: 1450 rpm	Design	: B

Locked rotor time : 25s (cold) 14s (hot)

Rev.	Changes Summary	Performed	Checked	Date
Performed by			Page 6 / 36	Revision
Checked by				
Date	12/04/2022			

TORQUE AND CURRENT VS SPEED CURVE



Three Phase Induction Motor - Squirrel Cage

Customer :

Product line : NEMA Premium Efficiency Three-Phase

Product code : 11431640

Catalog # : 01018ST3QIE215T-W22

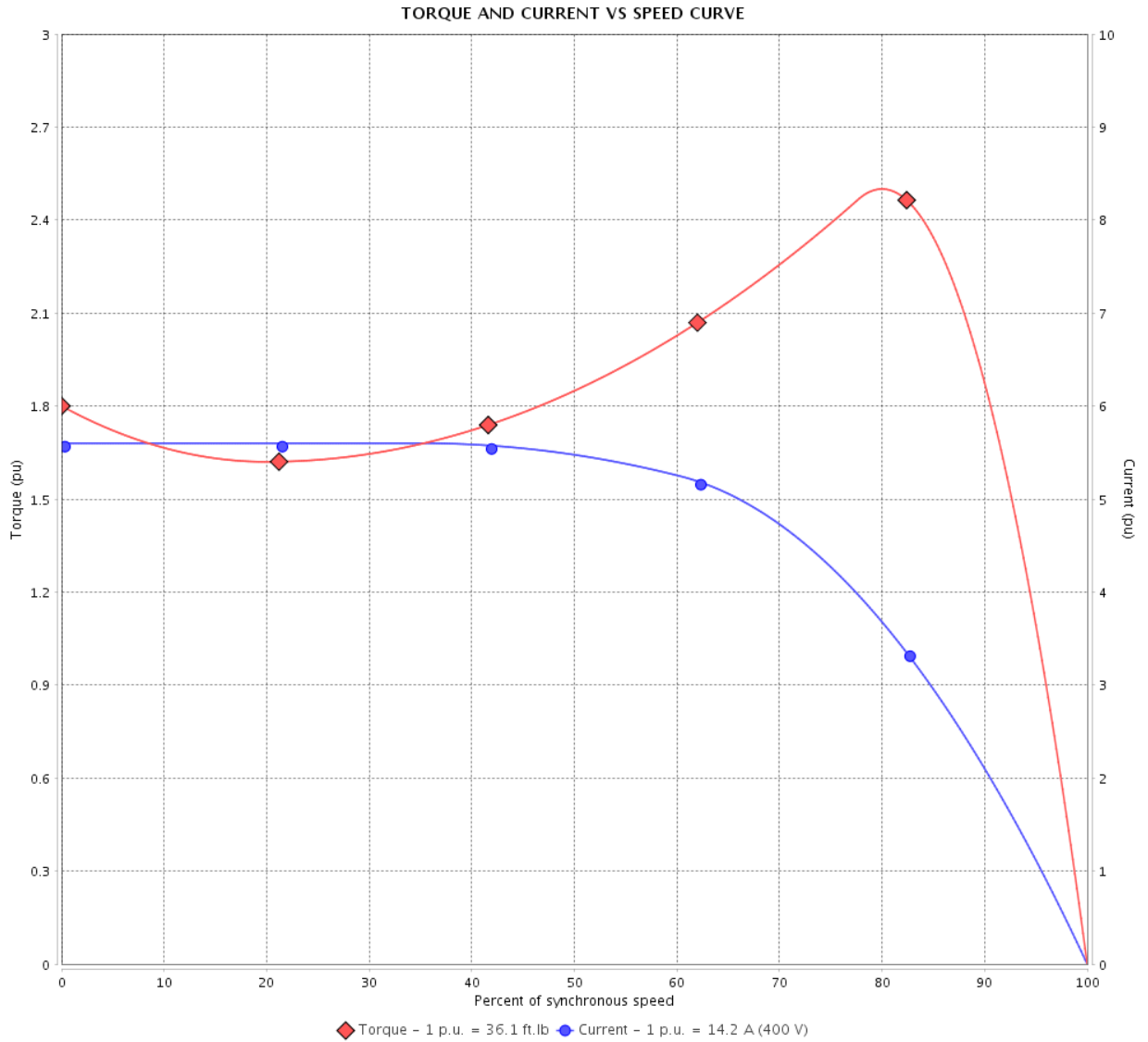

Performance : 400 V 50 Hz 4P IE2

Rated current	: 14.2 A	Moment of inertia (J)	: 1.51 sq.ft.lb
LRC	: 5.6	Duty cycle	: Cont.(S1)
Rated torque	: 36.1 ft.lb	Insulation class	: F
Locked rotor torque	: 180 %	Service factor	: 1.15
Breakdown torque	: 250 %	Temperature rise	: 80 K
Rated speed	: 1455 rpm	Design	: B

Locked rotor time : 25s (cold) 14s (hot)

Rev.	Changes Summary	Performed	Checked	Date
Performed by			Page 7 / 36	Revision
Checked by				
Date	12/04/2022			

TORQUE AND CURRENT VS SPEED CURVE

Three Phase Induction Motor - Squirrel Cage



Customer :

Product line : NEMA Premium Efficiency Three-Phase

Product code : 11431640

Catalog # : 01018ST3QIE215T-W22

TORQUE AND CURRENT VS SPEED CURVE

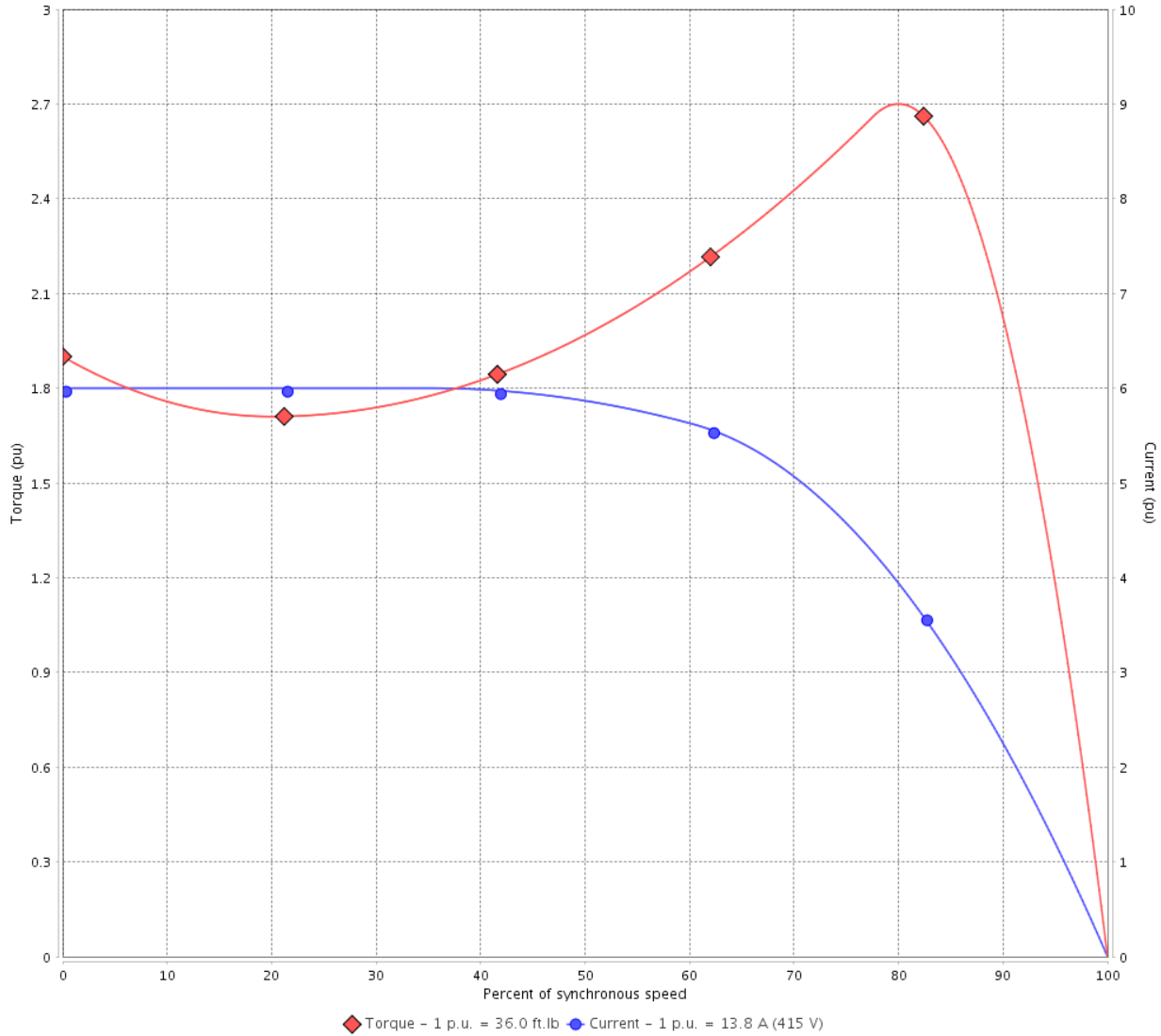

Performance : 415 V 50 Hz 4P IE2

Rated current	: 13.8 A	Moment of inertia (J)	: 1.51 sq.ft.lb
LRC	: 6.0	Duty cycle	: Cont.(S1)
Rated torque	: 36.0 ft.lb	Insulation class	: F
Locked rotor torque	: 190 %	Service factor	: 1.15
Breakdown torque	: 270 %	Temperature rise	: 80 K
Rated speed	: 1460 rpm	Design	: B

Locked rotor time : 25s (cold) 14s (hot)

Rev.	Changes Summary	Performed	Checked	Date
Performed by			Page 8 / 36	Revision
Checked by				
Date	12/04/2022			

LOAD PERFORMANCE CURVE

Three Phase Induction Motor - Squirrel Cage



Customer :

Product line : NEMA Premium Efficiency Three-Phase

Product code : 11431640

Catalog # : 01018ST3QIE215T-W22

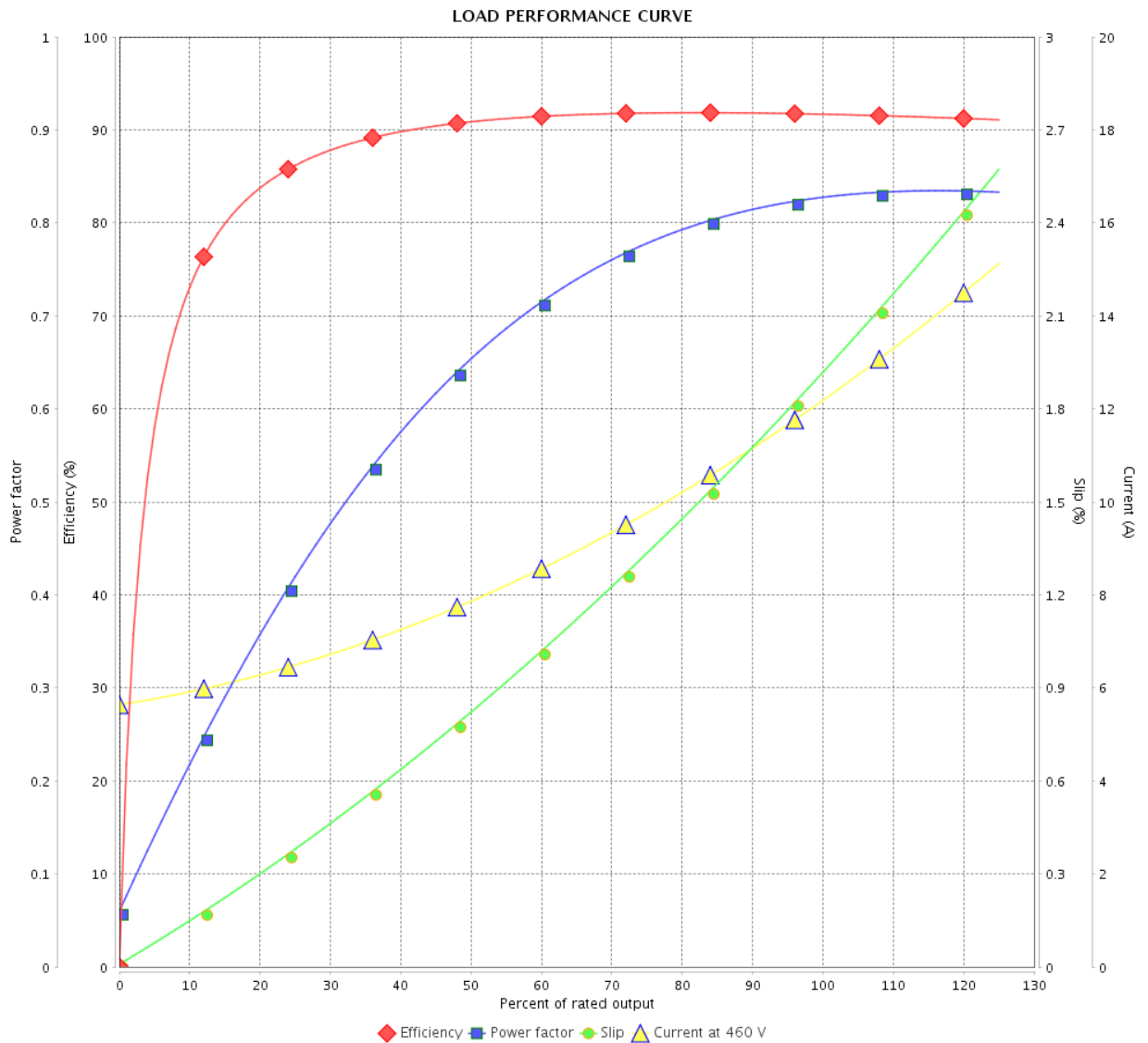

Performance : 460 V 60 Hz 4P

Rated current : 12.4 A
 LRC : 6.4
 Rated torque : 29.8 ft.lb
 Locked rotor torque : 200 %
 Breakdown torque : 295 %
 Rated speed : 1765 rpm

Moment of inertia (J) : 1.51 sq.ft.lb
 Duty cycle : Cont.(S1)
 Insulation class : F
 Service factor : 1.25
 Temperature rise : 80 K
 Design : B

Rev.	Changes Summary	Performed	Checked	Date
Performed by			Page	Revision
Checked by			9 / 36	
Date	12/04/2022			

LOAD PERFORMANCE CURVE

Three Phase Induction Motor - Squirrel Cage



Customer :

Product line : NEMA Premium Efficiency Three-Phase

Product code : 11431640

Catalog # : 01018ST3QIE215T-W22

LOAD PERFORMANCE CURVE

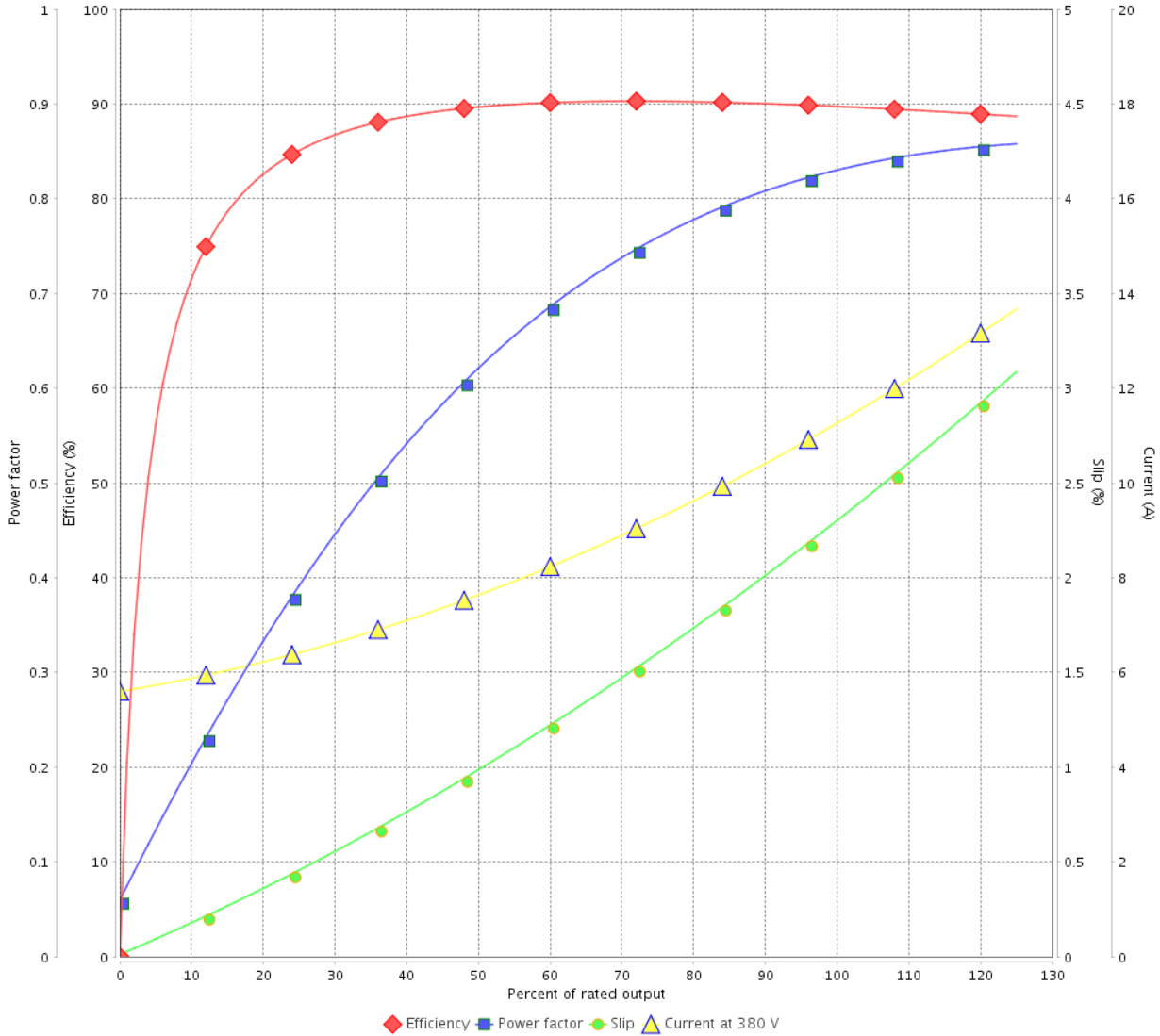

Performance : 380 V 50 Hz 4P IE3

Rated current	: 11.2 A	Moment of inertia (J)	: 1.51 sq.ft.lb
LRC	: 6.7	Duty cycle	: Cont.(S1)
Rated torque	: 26.9 ft.lb	Insulation class	: F
Locked rotor torque	: 200 %	Service factor	: 1.15
Breakdown torque	: 300 %	Temperature rise	: 80 K
Rated speed	: 1465 rpm	Design	: B

Rev.	Changes Summary	Performed	Checked	Date
Performed by			Page	Revision
Checked by			10 / 36	
Date	12/04/2022			

LOAD PERFORMANCE CURVE

Three Phase Induction Motor - Squirrel Cage



Customer :

Product line : NEMA Premium Efficiency Three-Phase

Product code : 11431640

Catalog # : 01018ST3QIE215T-W22

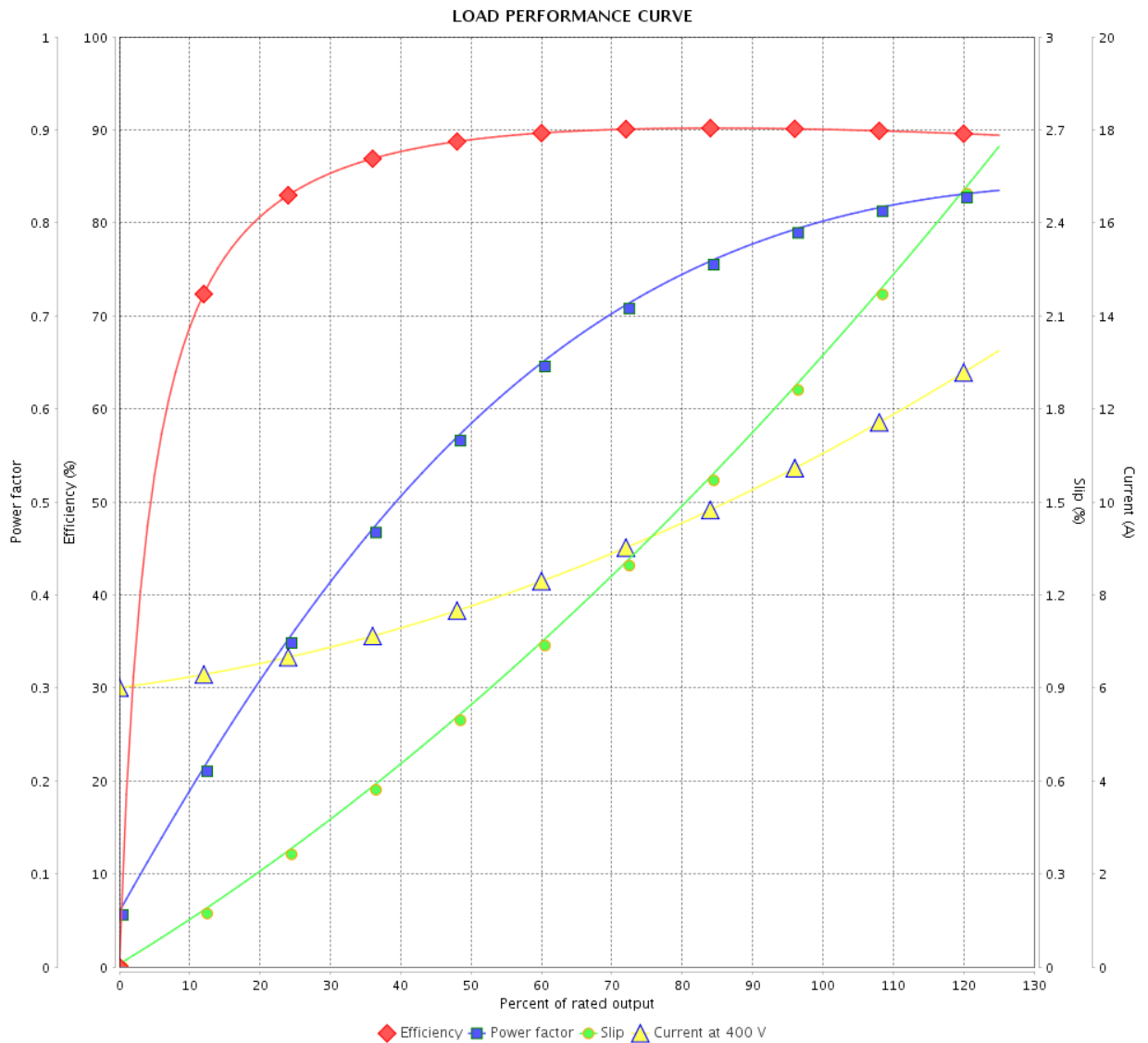

Performance : 400 V 50 Hz 4P IE3

Rated current : 11.0 A
 LRC : 7.1
 Rated torque : 26.8 ft.lb
 Locked rotor torque : 240 %
 Breakdown torque : 340 %
 Rated speed : 1470 rpm

Moment of inertia (J) : 1.51 sq.ft.lb
 Duty cycle : Cont.(S1)
 Insulation class : F
 Service factor : 1.15
 Temperature rise : 80 K
 Design : B

Rev.	Changes Summary	Performed	Checked	Date
Performed by			Page	Revision
Checked by			11 / 36	
Date	12/04/2022			

LOAD PERFORMANCE CURVE

Three Phase Induction Motor - Squirrel Cage



Customer :

Product line : NEMA Premium Efficiency Three-Phase

Product code : 11431640

Catalog # : 01018ST3QIE215T-W22

LOAD PERFORMANCE CURVE

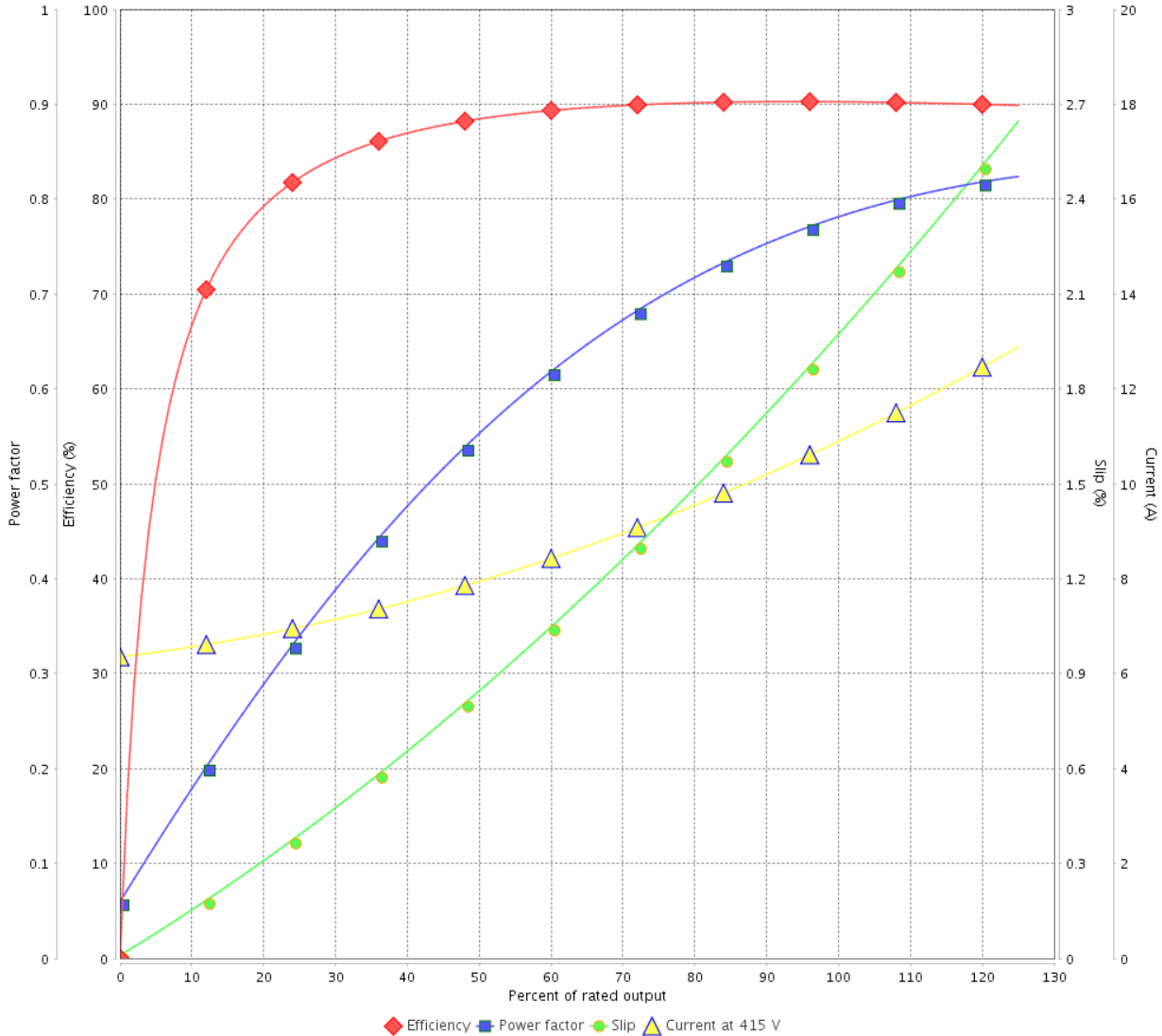

Performance : 415 V 50 Hz 4P IE3

Rated current : 10.9 A
 LRC : 7.5
 Rated torque : 26.8 ft.lb
 Locked rotor torque : 260 %
 Breakdown torque : 360 %
 Rated speed : 1470 rpm

Moment of inertia (J) : 1.51 sq.ft.lb
 Duty cycle : Cont.(S1)
 Insulation class : F
 Service factor : 1.15
 Temperature rise : 80 K
 Design : B

Rev.	Changes Summary	Performed	Checked	Date
Performed by			Page	Revision
Checked by				
Date				

LOAD PERFORMANCE CURVE

Three Phase Induction Motor - Squirrel Cage



Customer : _____

Product line : NEMA Premium Efficiency Three-Phase

Product code : 11431640

Catalog # : 01018ST3QIE215T-W22

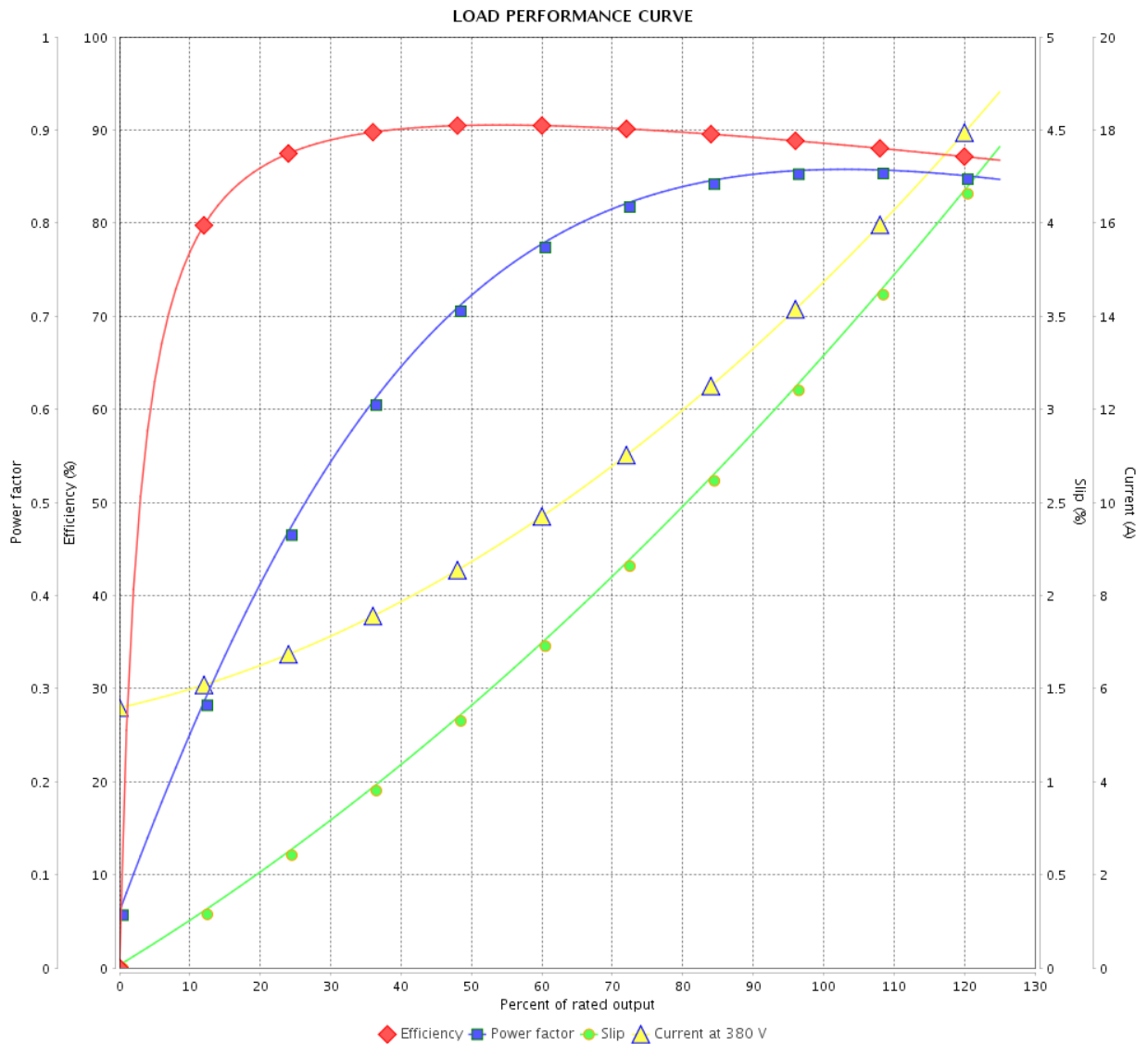

Performance : 380 V 50 Hz 4P IE1

Rated current : 15.0 A
 LRC : 5.1
 Rated torque : 36.2 ft.lb
 Locked rotor torque : 150 %
 Breakdown torque : 220 %
 Rated speed : 1450 rpm

Moment of inertia (J) : 1.51 sq.ft.lb
 Duty cycle : Cont.(S1)
 Insulation class : F
 Service factor : 1.15
 Temperature rise : 80 K
 Design : B

Rev.	Changes Summary	Performed	Checked	Date
Performed by		Page		Revision
Checked by		13 / 36		
Date		12/04/2022		

LOAD PERFORMANCE CURVE

Three Phase Induction Motor - Squirrel Cage



Customer :

Product line : NEMA Premium Efficiency Three-Phase

Product code : 11431640

Catalog # : 01018ST3QIE215T-W22

LOAD PERFORMANCE CURVE

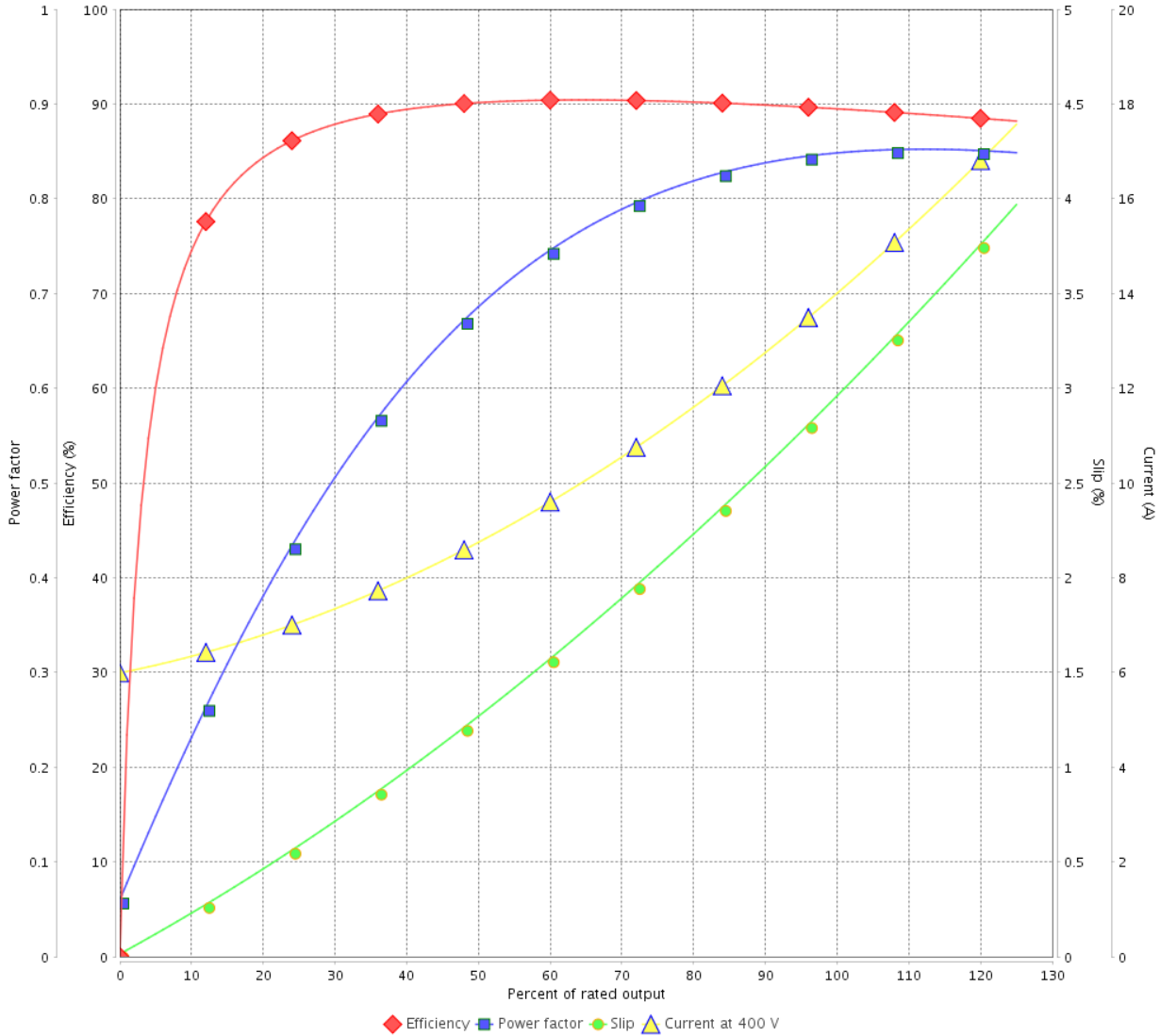

Performance : 400 V 50 Hz 4P IE2

Rated current : 14.2 A
 LRC : 5.6
 Rated torque : 36.1 ft.lb
 Locked rotor torque : 180 %
 Breakdown torque : 250 %
 Rated speed : 1455 rpm

Moment of inertia (J) : 1.51 sq.ft.lb
 Duty cycle : Cont.(S1)
 Insulation class : F
 Service factor : 1.15
 Temperature rise : 80 K
 Design : B

Rev.	Changes Summary	Performed	Checked	Date
Performed by		Page		Revision
Checked by		14 / 36		
Date		12/04/2022		

LOAD PERFORMANCE CURVE

Three Phase Induction Motor - Squirrel Cage



Customer : _____

Product line : NEMA Premium Efficiency Three-Phase

Product code : 11431640

Catalog # : 01018ST3QIE215T-W22

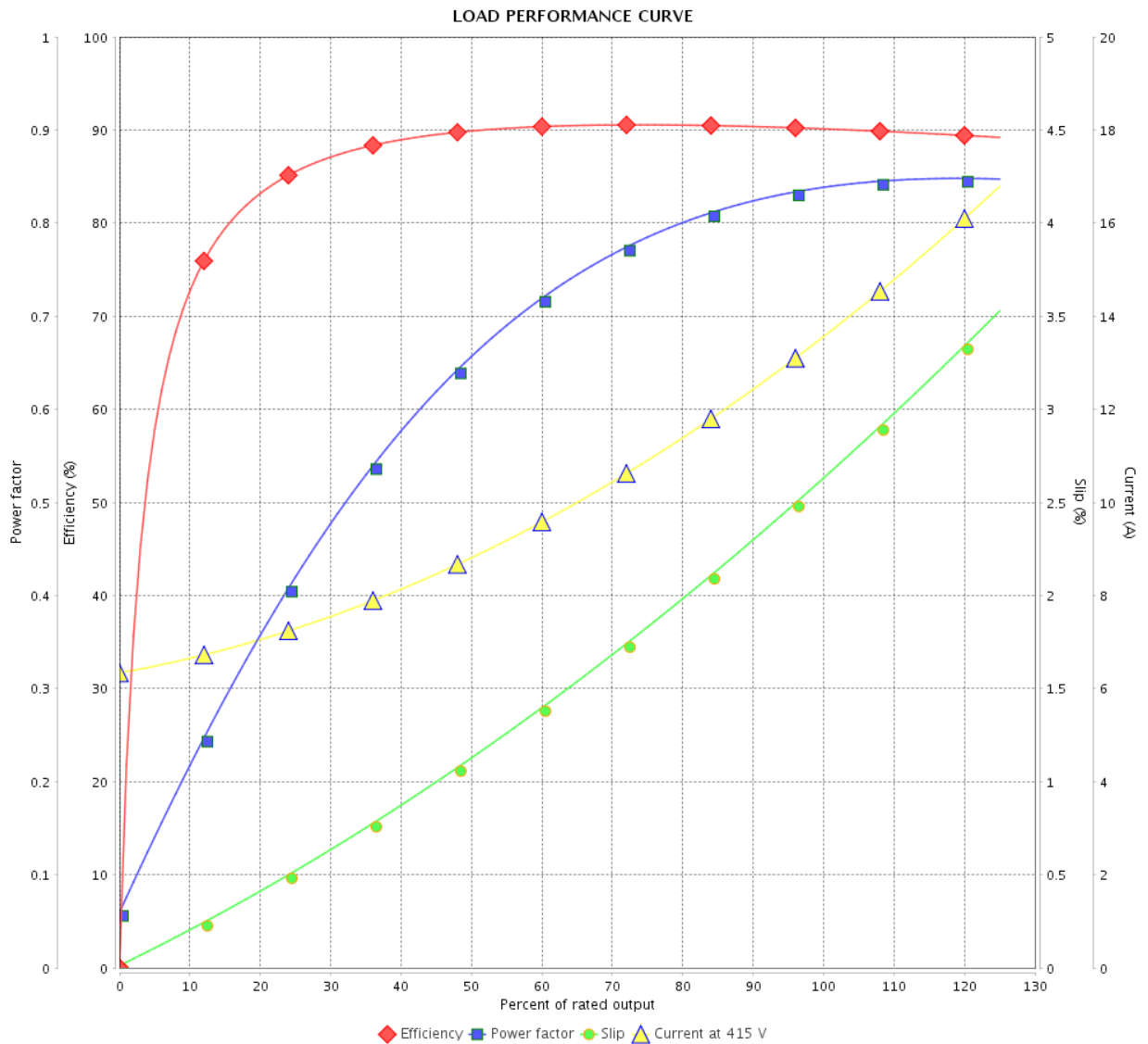

Performance : 415 V 50 Hz 4P IE2

Rated current : 13.8 A
 LRC : 6.0
 Rated torque : 36.0 ft.lb
 Locked rotor torque : 190 %
 Breakdown torque : 270 %
 Rated speed : 1460 rpm

Moment of inertia (J) : 1.51 sq.ft.lb
 Duty cycle : Cont.(S1)
 Insulation class : F
 Service factor : 1.15
 Temperature rise : 80 K
 Design : B

Rev.	Changes Summary	Performed	Checked	Date
Performed by		Page		Revision
Checked by		15 / 36		
Date		12/04/2022		

THERMAL LIMIT CURVE

Three Phase Induction Motor - Squirrel Cage



Customer :

Product line : NEMA Premium Efficiency Three-Phase
Product code : 11431640
Catalog # : 01018ST3QIE215T-W22

Performance : 460 V 60 Hz 4P

Rated current	: 12.4 A	Moment of inertia (J)	: 1.51 sq.ft.lb
LRC	: 6.4	Duty cycle	: Cont.(S1)
Rated torque	: 29.8 ft.lb	Insulation class	: F
Locked rotor torque	: 200 %	Service factor	: 1.25
Breakdown torque	: 295 %	Temperature rise	: 80 K
Rated speed	: 1765 rpm	Design	: B

Heating constant

Cooling constant

Rev.	Changes Summary	Performed	Checked	Date
Performed by				
Checked by			Page	Revision
Date	12/04/2022		16 / 36	

THERMAL LIMIT CURVE

Three Phase Induction Motor - Squirrel Cage



Customer : _____

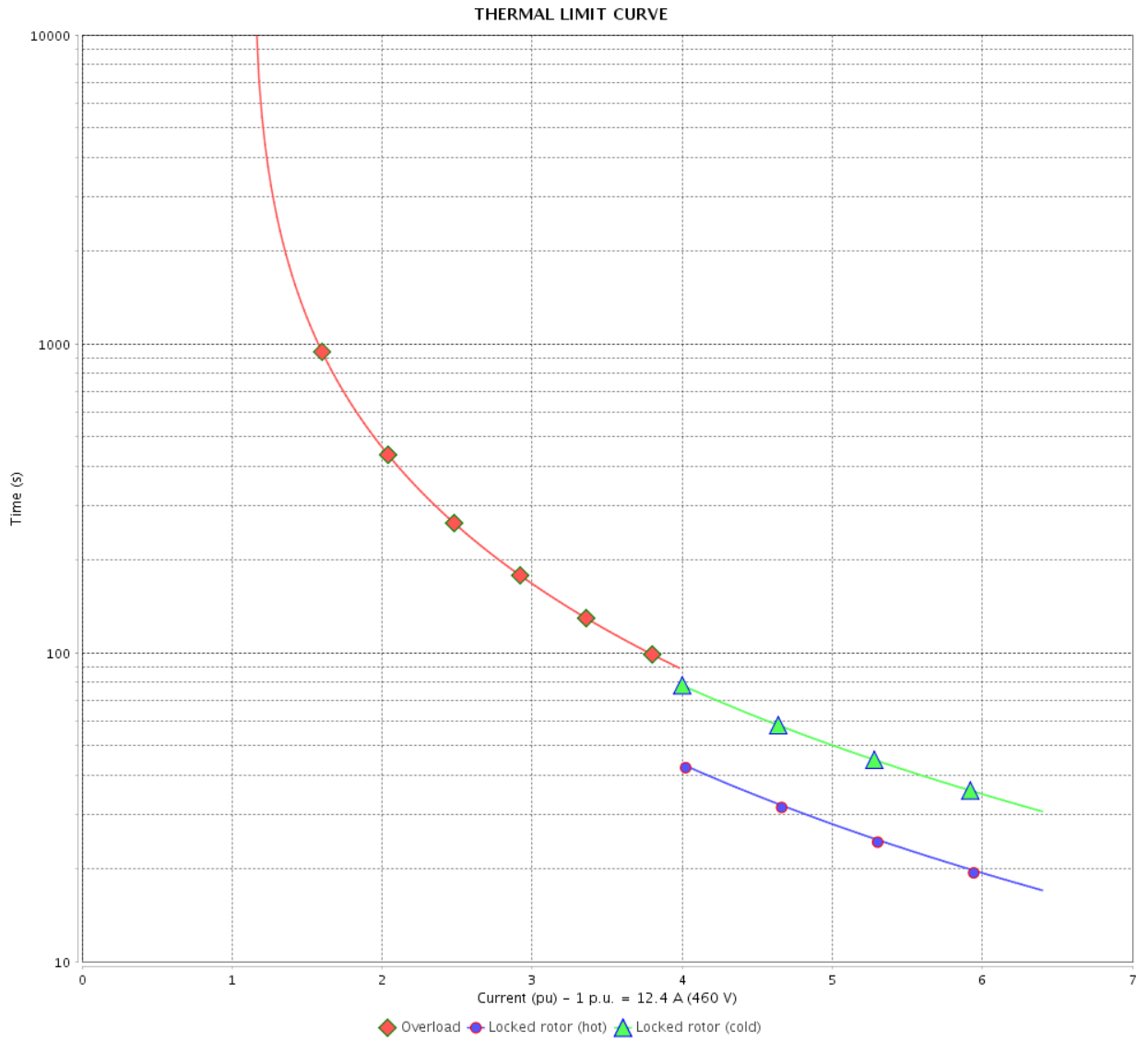

Rev.	Changes Summary	Performed	Checked	Date
Performed by				
Checked by				
Date				
			Page	Revision
			17 / 36	

THERMAL LIMIT CURVE



Three Phase Induction Motor - Squirrel Cage

Customer :

Product line : NEMA Premium Efficiency Three-Phase
Product code : 11431640
Catalog # : 01018ST3QIE215T-W22

Performance : 380 V 50 Hz 4P IE3

Rated current	: 11.2 A	Moment of inertia (J)	: 1.51 sq.ft.lb
LRC	: 6.7	Duty cycle	: Cont.(S1)
Rated torque	: 26.9 ft.lb	Insulation class	: F
Locked rotor torque	: 200 %	Service factor	: 1.15
Breakdown torque	: 300 %	Temperature rise	: 80 K
Rated speed	: 1465 rpm	Design	: B

Heating constant

Cooling constant

Rev.	Changes Summary	Performed	Checked	Date
Performed by				
Checked by			Page	Revision
Date	12/04/2022		18 / 36	

THERMAL LIMIT CURVE

Three Phase Induction Motor - Squirrel Cage



Customer : _____

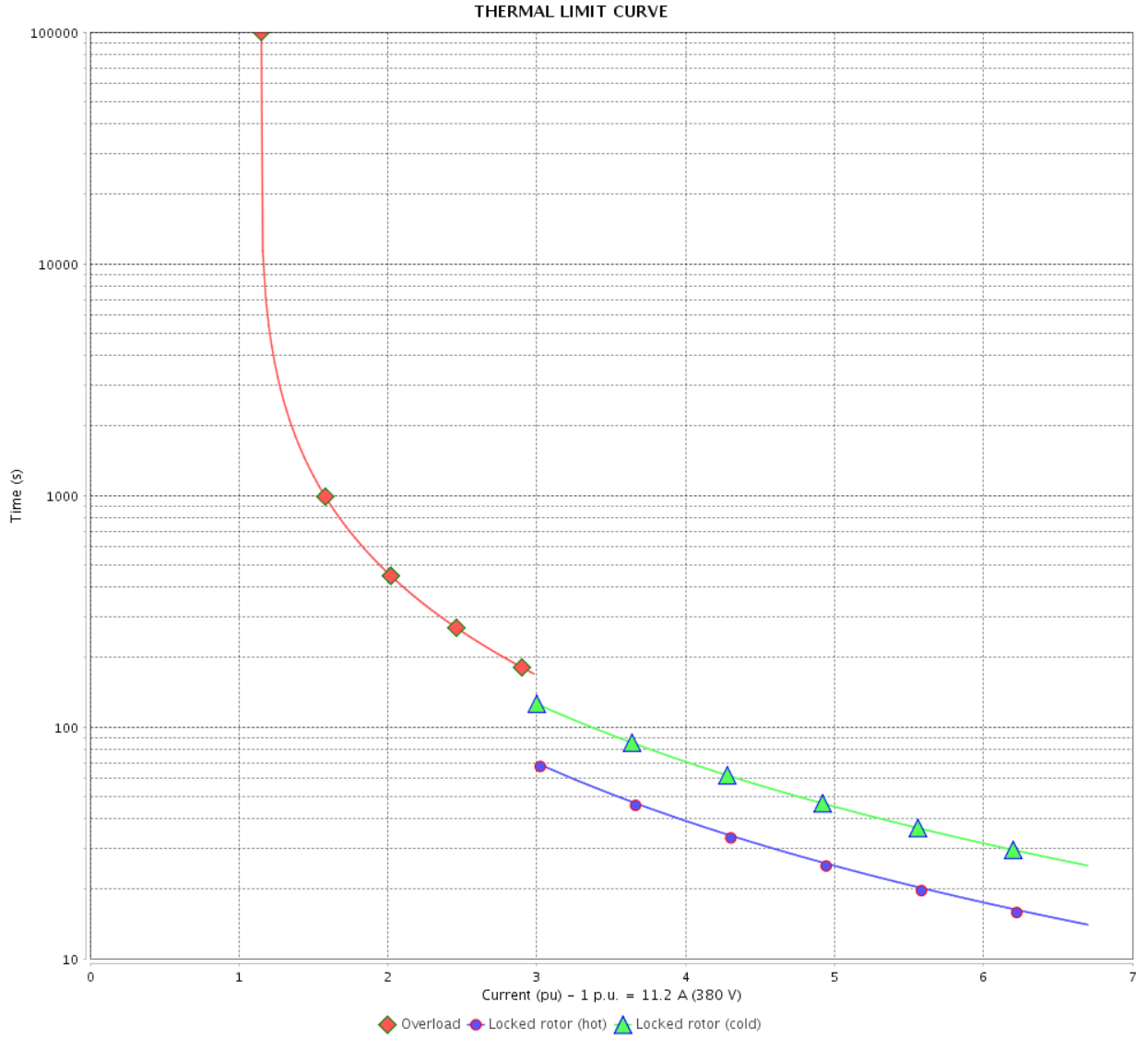

Rev.	Changes Summary	Performed	Checked	Date
Performed by		Page		Revision
Checked by		19 / 36		
Date		12/04/2022		

THERMAL LIMIT CURVE



Three Phase Induction Motor - Squirrel Cage

Customer :

Product line : NEMA Premium Efficiency Three-Phase
Product code : 11431640
Catalog # : 01018ST3QIE215T-W22

Performance : 400 V 50 Hz 4P IE3

Rated current	: 11.0 A	Moment of inertia (J)	: 1.51 sq.ft.lb
LRC	: 7.1	Duty cycle	: Cont.(S1)
Rated torque	: 26.8 ft.lb	Insulation class	: F
Locked rotor torque	: 240 %	Service factor	: 1.15
Breakdown torque	: 340 %	Temperature rise	: 80 K
Rated speed	: 1470 rpm	Design	: B

Heating constant

Cooling constant

Rev.	Changes Summary	Performed	Checked	Date
Performed by				
Checked by			Page	Revision
Date	12/04/2022		20 / 36	

THERMAL LIMIT CURVE

Three Phase Induction Motor - Squirrel Cage



Customer : _____

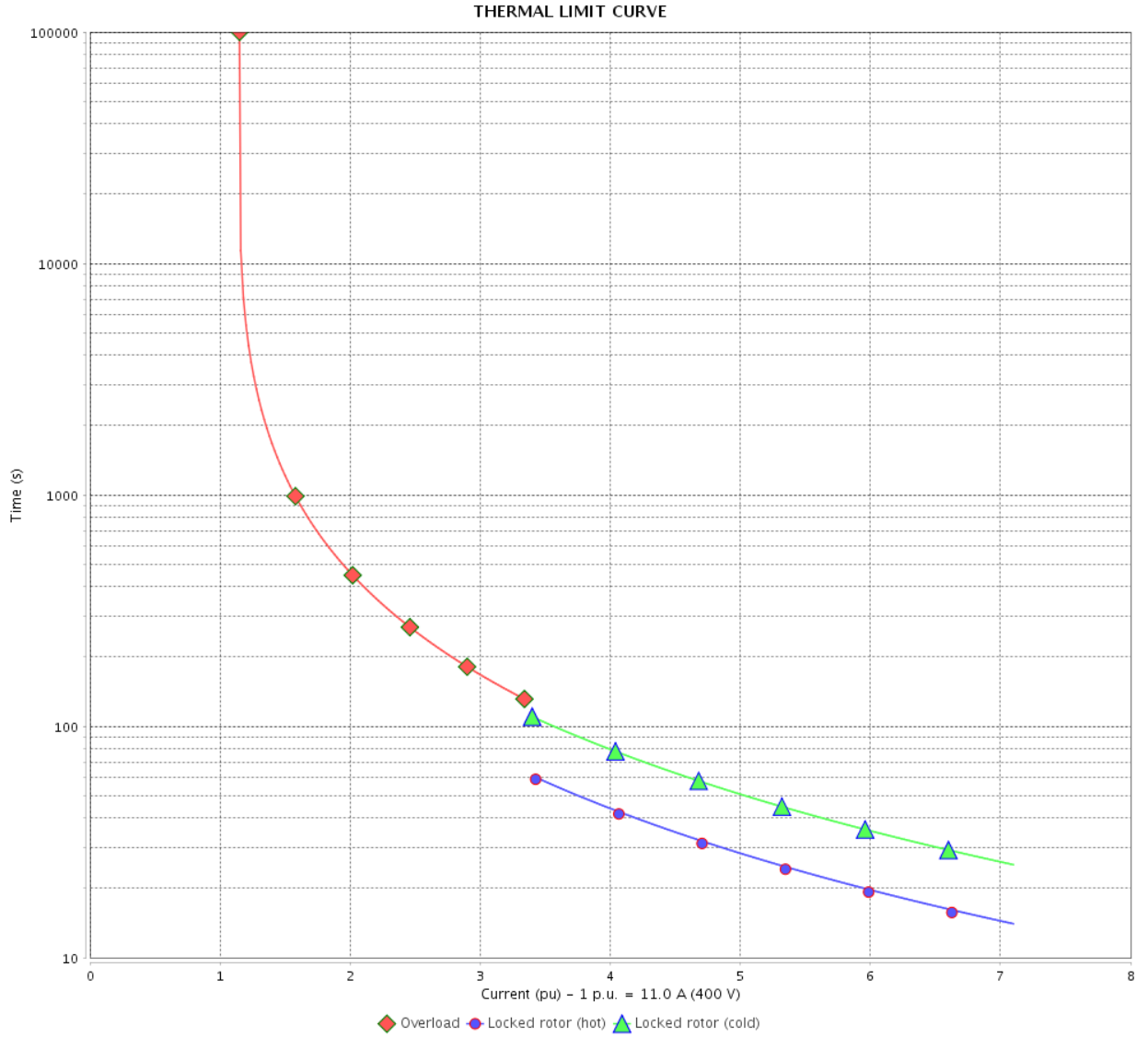

Rev.	Changes Summary	Performed	Checked	Date
Performed by		Page		Revision
Checked by		21 / 36		
Date		12/04/2022		

THERMAL LIMIT CURVE



Three Phase Induction Motor - Squirrel Cage

Customer :

Product line : NEMA Premium Efficiency Three-Phase
Product code : 11431640
Catalog # : 01018ST3QIE215T-W22

Performance : 415 V 50 Hz 4P IE3

Rated current	: 10.9 A	Moment of inertia (J)	: 1.51 sq.ft.lb
LRC	: 7.5	Duty cycle	: Cont.(S1)
Rated torque	: 26.8 ft.lb	Insulation class	: F
Locked rotor torque	: 260 %	Service factor	: 1.15
Breakdown torque	: 360 %	Temperature rise	: 80 K
Rated speed	: 1470 rpm	Design	: B

Heating constant

Cooling constant

Rev.	Changes Summary	Performed	Checked	Date
Performed by				
Checked by			Page	Revision
Date	12/04/2022		22 / 36	

THERMAL LIMIT CURVE

Three Phase Induction Motor - Squirrel Cage



Customer : _____

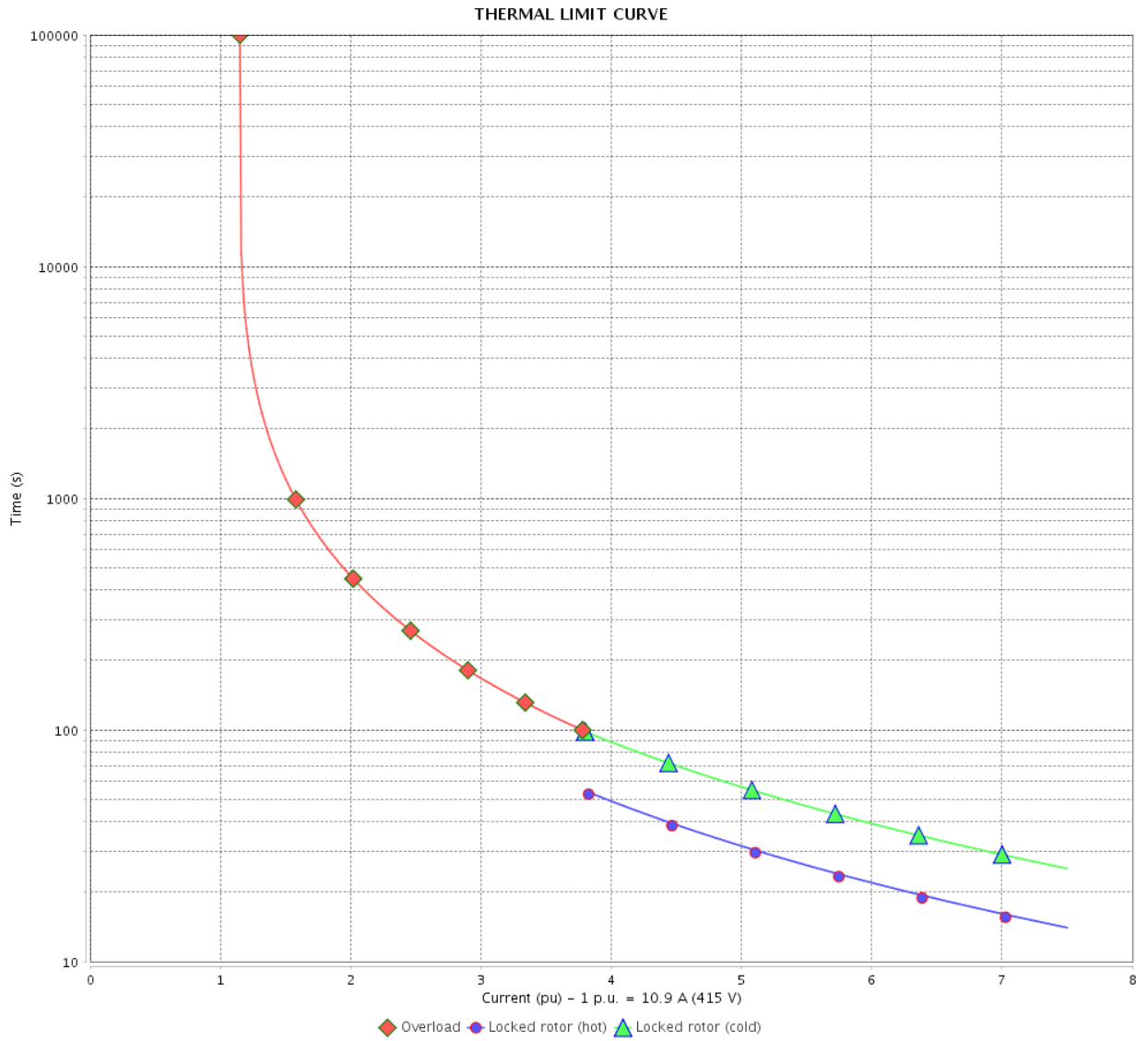

Rev.	Changes Summary	Performed	Checked	Date
Performed by		Page 23 / 36		Revision
Checked by				
Date				

THERMAL LIMIT CURVE



Three Phase Induction Motor - Squirrel Cage

Customer :

Product line : NEMA Premium Efficiency Three-Phase
Product code : 11431640
Catalog # : 01018ST3QIE215T-W22

Performance : 380 V 50 Hz 4P IE1

Rated current	: 15.0 A	Moment of inertia (J)	: 1.51 sq.ft.lb
LRC	: 5.1	Duty cycle	: Cont.(S1)
Rated torque	: 36.2 ft.lb	Insulation class	: F
Locked rotor torque	: 150 %	Service factor	: 1.15
Breakdown torque	: 220 %	Temperature rise	: 80 K
Rated speed	: 1450 rpm	Design	: B

Heating constant

Cooling constant

Rev.	Changes Summary	Performed	Checked	Date
Performed by				
Checked by			Page	Revision
Date	12/04/2022		24 / 36	

THERMAL LIMIT CURVE

Three Phase Induction Motor - Squirrel Cage



Customer : _____

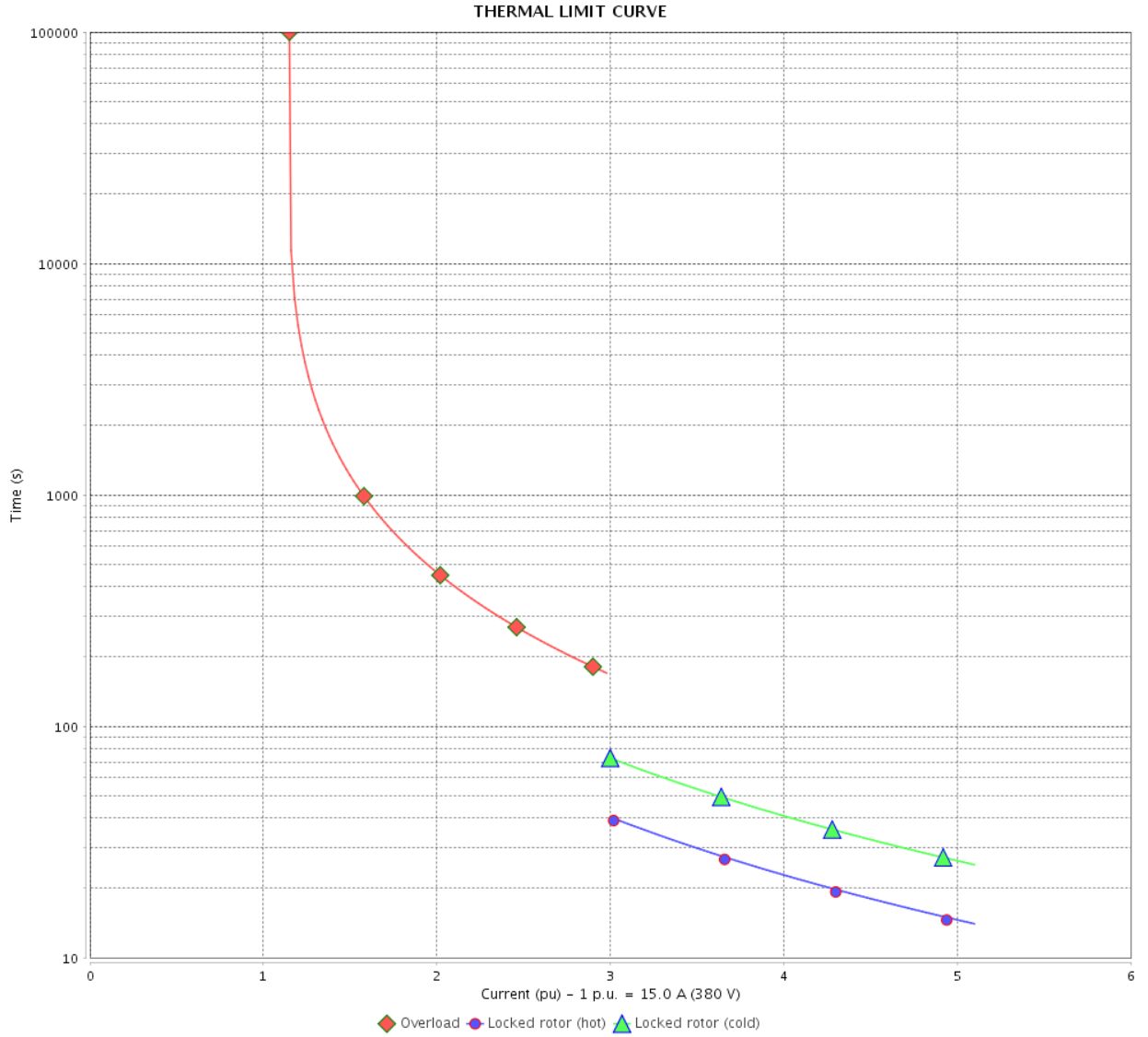

Rev.	Changes Summary	Performed	Checked	Date
Performed by				
Checked by				
Date				
			Page	Revision
			25 / 36	

THERMAL LIMIT CURVE



Three Phase Induction Motor - Squirrel Cage

Customer :

Product line : NEMA Premium Efficiency Three-Phase
Product code : 11431640
Catalog # : 01018ST3QIE215T-W22

Performance : 400 V 50 Hz 4P IE2

Rated current	: 14.2 A	Moment of inertia (J)	: 1.51 sq.ft.lb
LRC	: 5.6	Duty cycle	: Cont.(S1)
Rated torque	: 36.1 ft.lb	Insulation class	: F
Locked rotor torque	: 180 %	Service factor	: 1.15
Breakdown torque	: 250 %	Temperature rise	: 80 K
Rated speed	: 1455 rpm	Design	: B

Heating constant

Cooling constant

Rev.	Changes Summary	Performed	Checked	Date
Performed by				
Checked by			Page	Revision
Date	12/04/2022		26 / 36	

THERMAL LIMIT CURVE

Three Phase Induction Motor - Squirrel Cage



Customer : _____

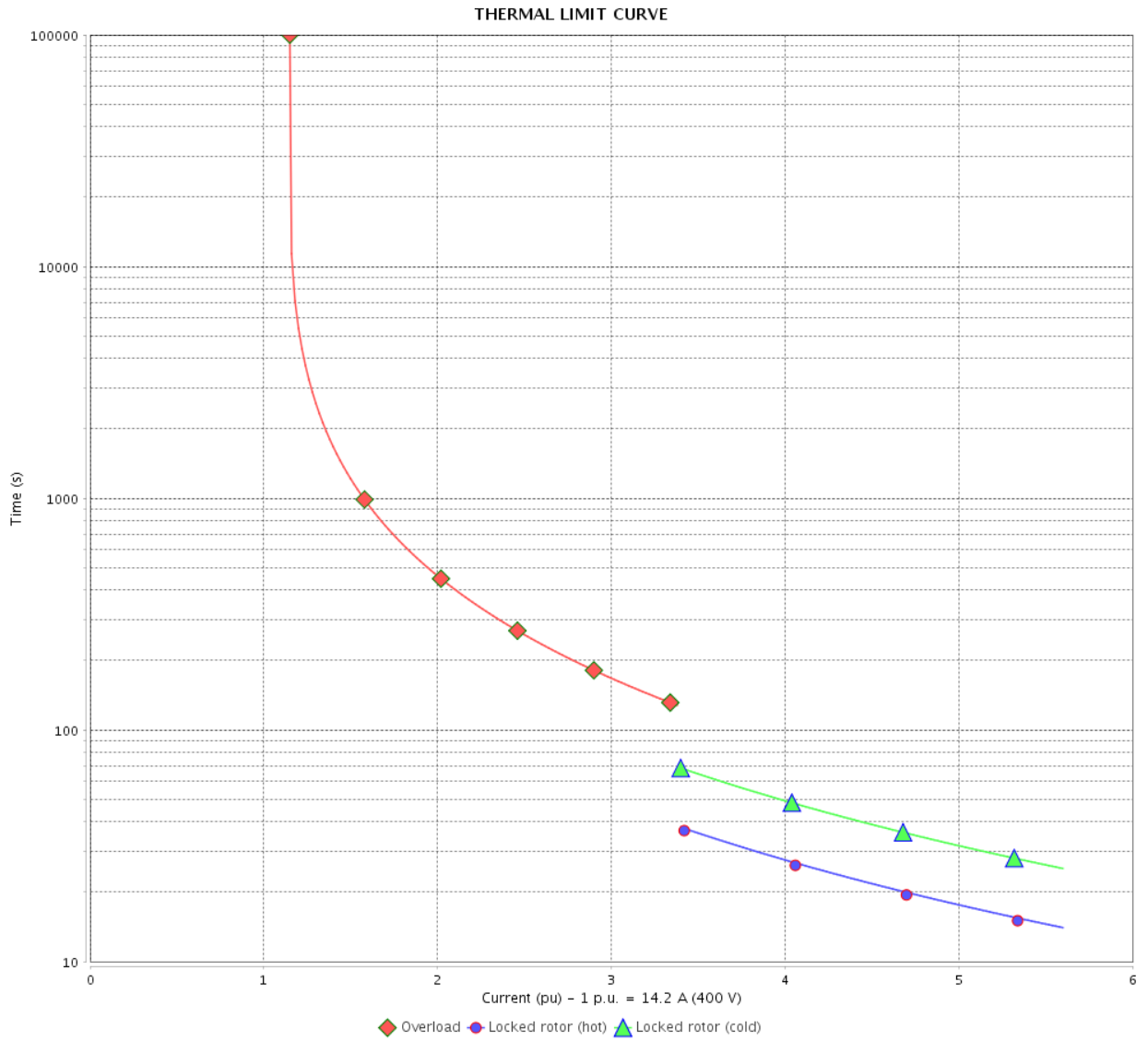

Rev.	Changes Summary	Performed	Checked	Date
Performed by		Page 27 / 36		Revision
Checked by				
Date				

THERMAL LIMIT CURVE



Three Phase Induction Motor - Squirrel Cage

Customer :

Product line : NEMA Premium Efficiency Three-Phase
Product code : 11431640
Catalog # : 01018ST3QIE215T-W22

Performance : 415 V 50 Hz 4P IE2

Rated current	: 13.8 A	Moment of inertia (J)	: 1.51 sq.ft.lb
LRC	: 6.0	Duty cycle	: Cont.(S1)
Rated torque	: 36.0 ft.lb	Insulation class	: F
Locked rotor torque	: 190 %	Service factor	: 1.15
Breakdown torque	: 270 %	Temperature rise	: 80 K
Rated speed	: 1460 rpm	Design	: B

Heating constant

Cooling constant

Rev.	Changes Summary	Performed	Checked	Date
Performed by				
Checked by			Page	Revision
Date	12/04/2022		28 / 36	

THERMAL LIMIT CURVE

Three Phase Induction Motor - Squirrel Cage



Customer : _____

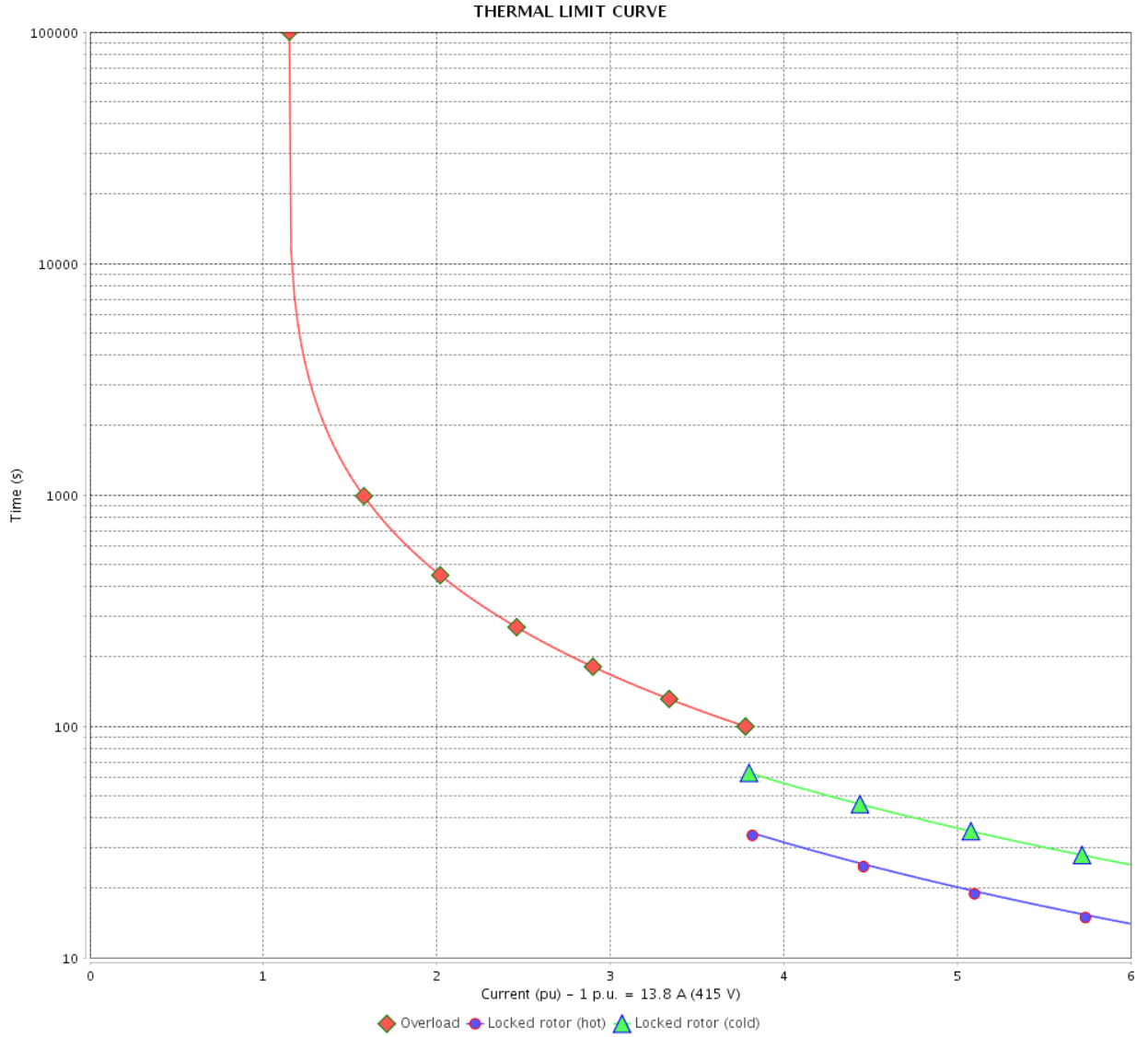

Rev.	Changes Summary	Performed	Checked	Date
Performed by		Page 29 / 36		Revision
Checked by				
Date				

VFD OPERATION CURVE

Three Phase Induction Motor - Squirrel Cage



Customer :

Product line : NEMA Premium Efficiency Three-Phase

Product code : 11431640

Catalog # : 01018ST3QIE215T-W22

VFD OPERATION CURVE

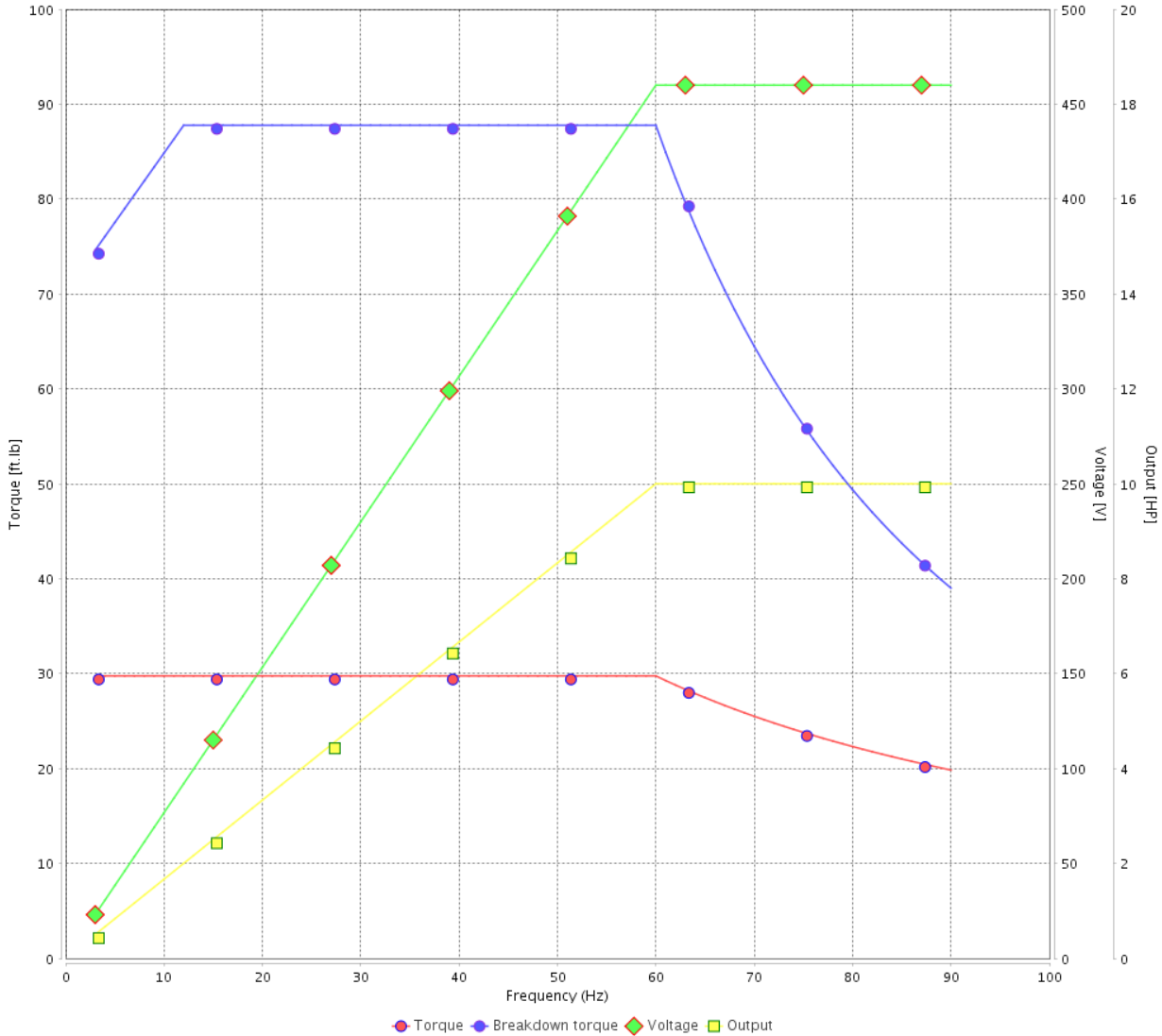

Performance : 460 V 60 Hz 4P

Rated current : 12.4 A
 LRC : 6.4
 Rated torque : 29.8 ft.lb
 Locked rotor torque : 200 %
 Breakdown torque : 295 %
 Rated speed : 1765 rpm

Moment of inertia (J) : 1.51 sq.ft.lb
 Duty cycle : Cont.(S1)
 Insulation class : F
 Service factor : 1.25
 Temperature rise : 80 K
 Design : B

Rev.	Changes Summary	Performed	Checked	Date
Performed by			Page	Revision
Checked by				
Date				

VFD OPERATION CURVE

Three Phase Induction Motor - Squirrel Cage



Customer : _____

Product line : NEMA Premium Efficiency Three-Phase

Product code : 11431640

Catalog # : 01018ST3QIE215T-W22

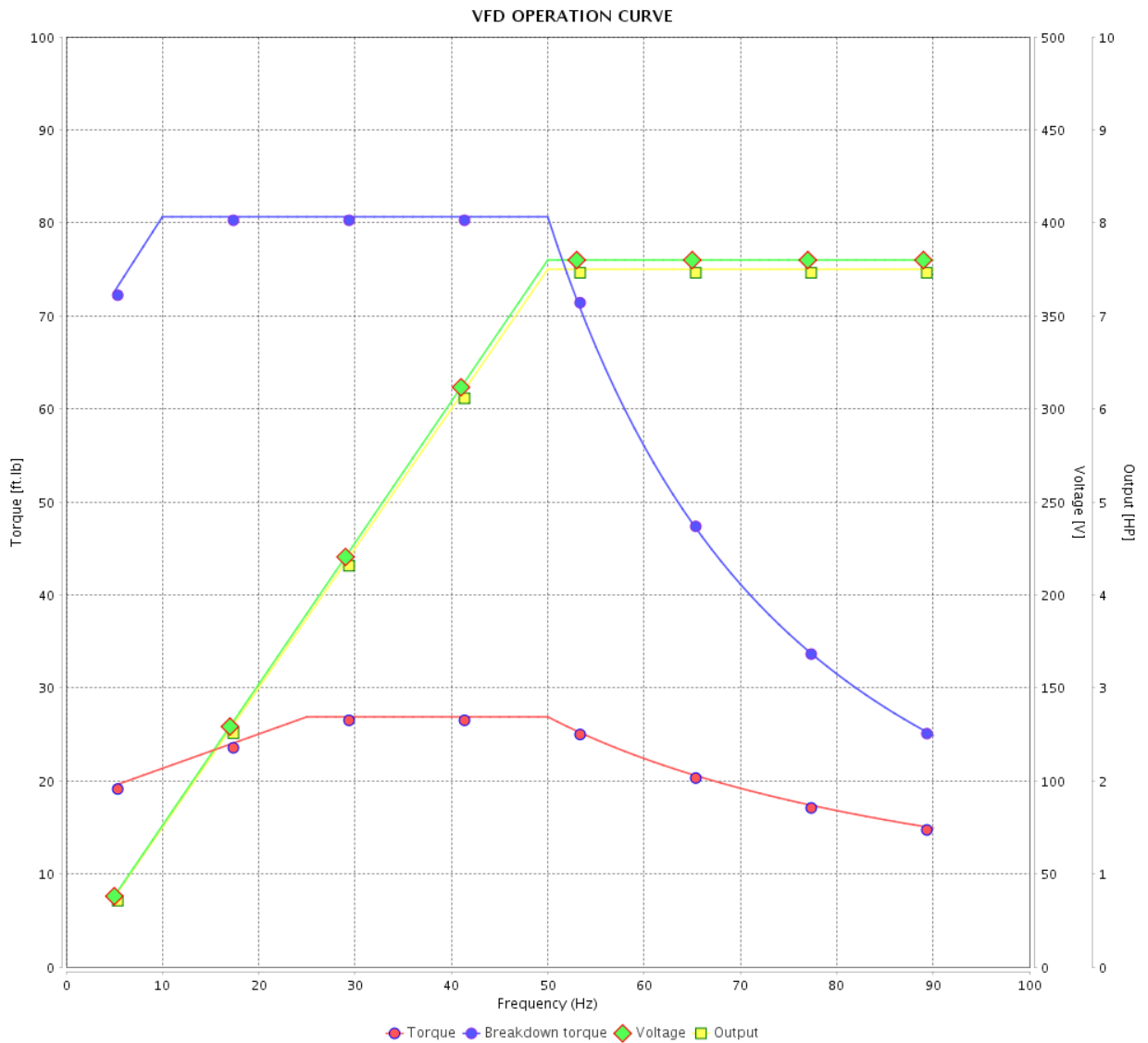

Performance : 380 V 50 Hz 4P IE3

Rated current : 11.2 A
 LRC : 6.7
 Rated torque : 26.9 ft.lb
 Locked rotor torque : 200 %
 Breakdown torque : 300 %
 Rated speed : 1465 rpm

Moment of inertia (J) : 1.51 sq.ft.lb
 Duty cycle : Cont.(S1)
 Insulation class : F
 Service factor : 1.15
 Temperature rise : 80 K
 Design : B

Rev.	Changes Summary	Performed	Checked	Date
Performed by			Page	Revision
Checked by				
Date				

VFD OPERATION CURVE

Three Phase Induction Motor - Squirrel Cage



Customer :

Product line : NEMA Premium Efficiency Three-Phase

Product code : 11431640

Catalog # : 01018ST3QIE215T-W22

VFD OPERATION CURVE

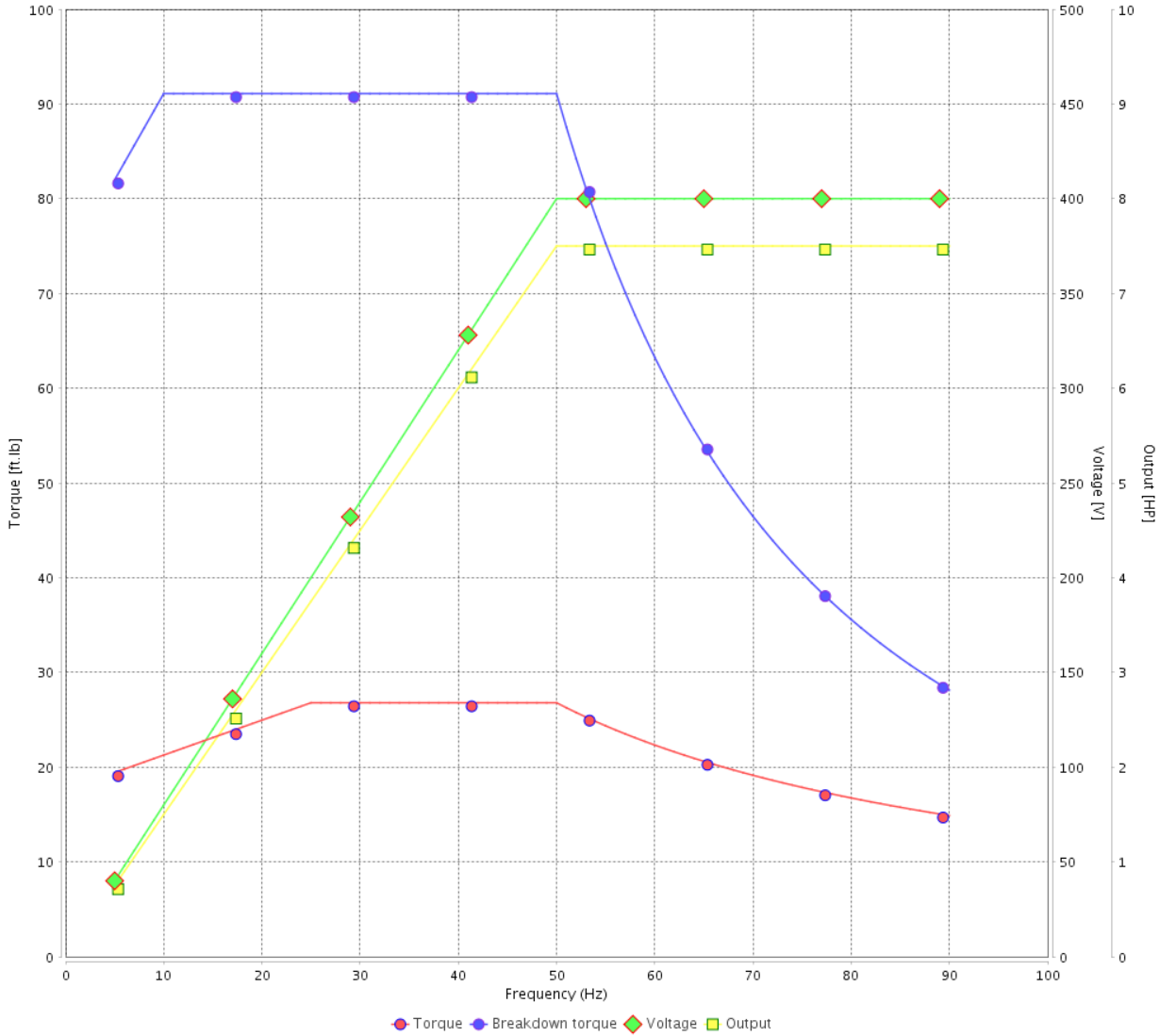

Performance : 400 V 50 Hz 4P IE3

Rated current : 11.0 A
 LRC : 7.1
 Rated torque : 26.8 ft.lb
 Locked rotor torque : 240 %
 Breakdown torque : 340 %
 Rated speed : 1470 rpm

Moment of inertia (J) : 1.51 sq.ft.lb
 Duty cycle : Cont.(S1)
 Insulation class : F
 Service factor : 1.15
 Temperature rise : 80 K
 Design : B

Rev.	Changes Summary	Performed	Checked	Date
Performed by			Page	Revision
Checked by				
Date				

VFD OPERATION CURVE

Three Phase Induction Motor - Squirrel Cage



Customer :

Product line : NEMA Premium Efficiency Three-Phase

Product code : 11431640

Catalog # : 01018ST3QIE215T-W22

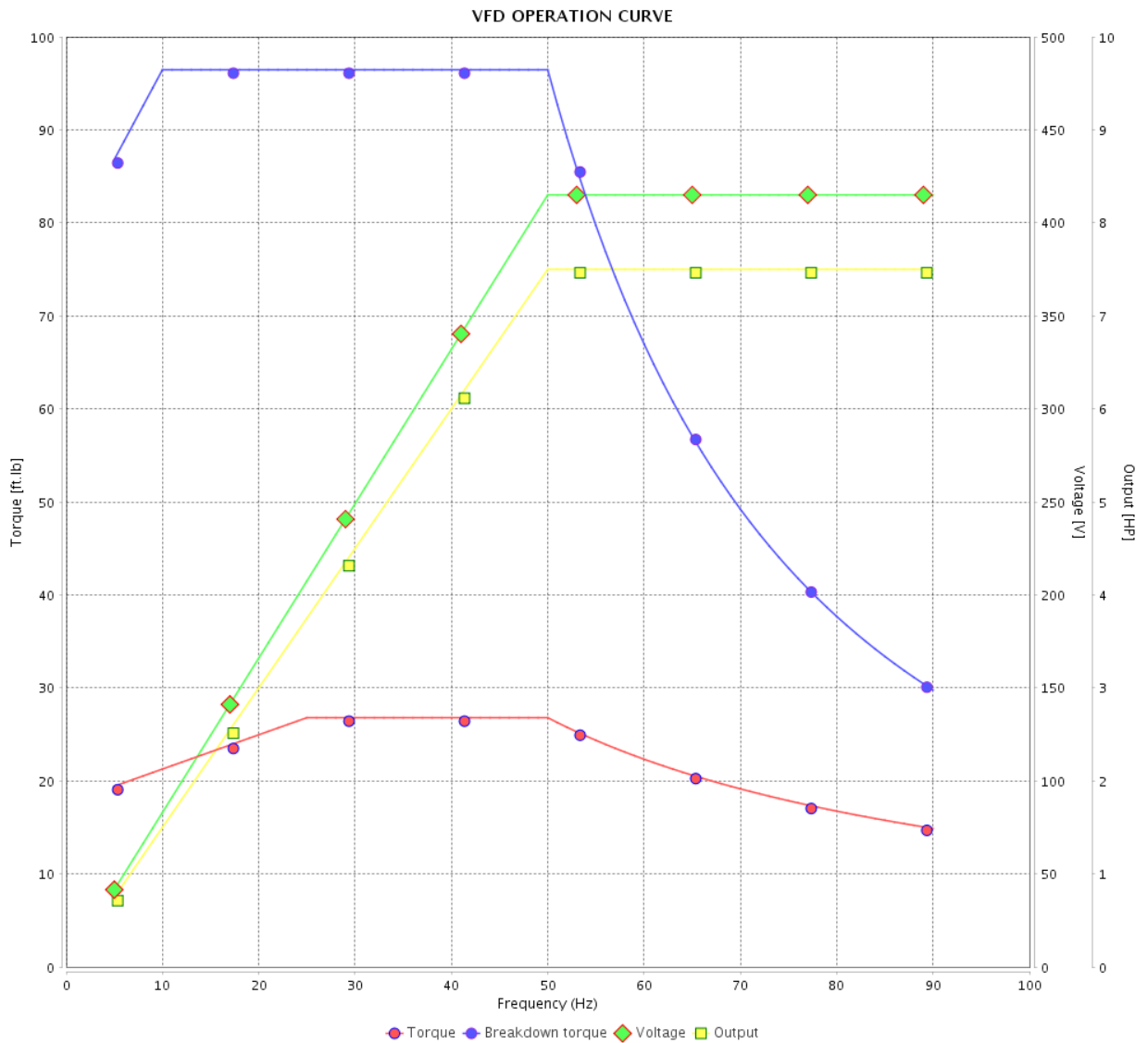

Performance : 415 V 50 Hz 4P IE3

Rated current : 10.9 A
 LRC : 7.5
 Rated torque : 26.8 ft.lb
 Locked rotor torque : 260 %
 Breakdown torque : 360 %
 Rated speed : 1470 rpm

Moment of inertia (J) : 1.51 sq.ft.lb
 Duty cycle : Cont.(S1)
 Insulation class : F
 Service factor : 1.15
 Temperature rise : 80 K
 Design : B

Rev.	Changes Summary	Performed	Checked	Date
Performed by		Page		Revision
Checked by		33 / 36		
Date	12/04/2022			

VFD OPERATION CURVE

Three Phase Induction Motor - Squirrel Cage



Customer :

Product line : NEMA Premium Efficiency Three-Phase

Product code : 11431640

Catalog # : 01018ST3QIE215T-W22

VFD OPERATION CURVE

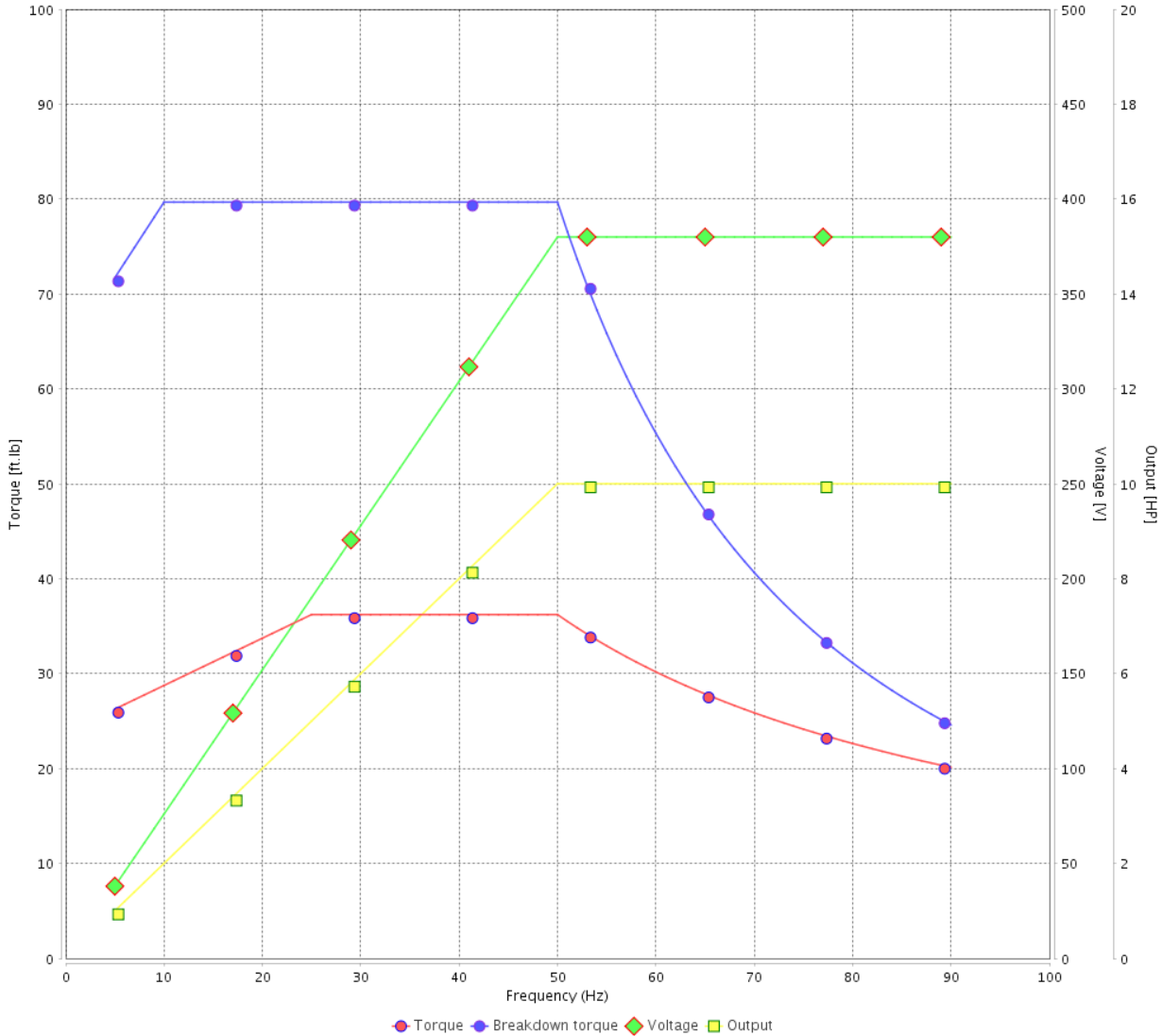

Performance : 380 V 50 Hz 4P IE1

Rated current : 15.0 A
 LRC : 5.1
 Rated torque : 36.2 ft.lb
 Locked rotor torque : 150 %
 Breakdown torque : 220 %
 Rated speed : 1450 rpm

Moment of inertia (J) : 1.51 sq.ft.lb
 Duty cycle : Cont.(S1)
 Insulation class : F
 Service factor : 1.15
 Temperature rise : 80 K
 Design : B

Rev.	Changes Summary	Performed	Checked	Date
Performed by			Page 34 / 36	Revision
Checked by				
Date	12/04/2022			

VFD OPERATION CURVE

Three Phase Induction Motor - Squirrel Cage



Customer :

Product line : NEMA Premium Efficiency Three-Phase

Product code : 11431640

Catalog # : 01018ST3QIE215T-W22

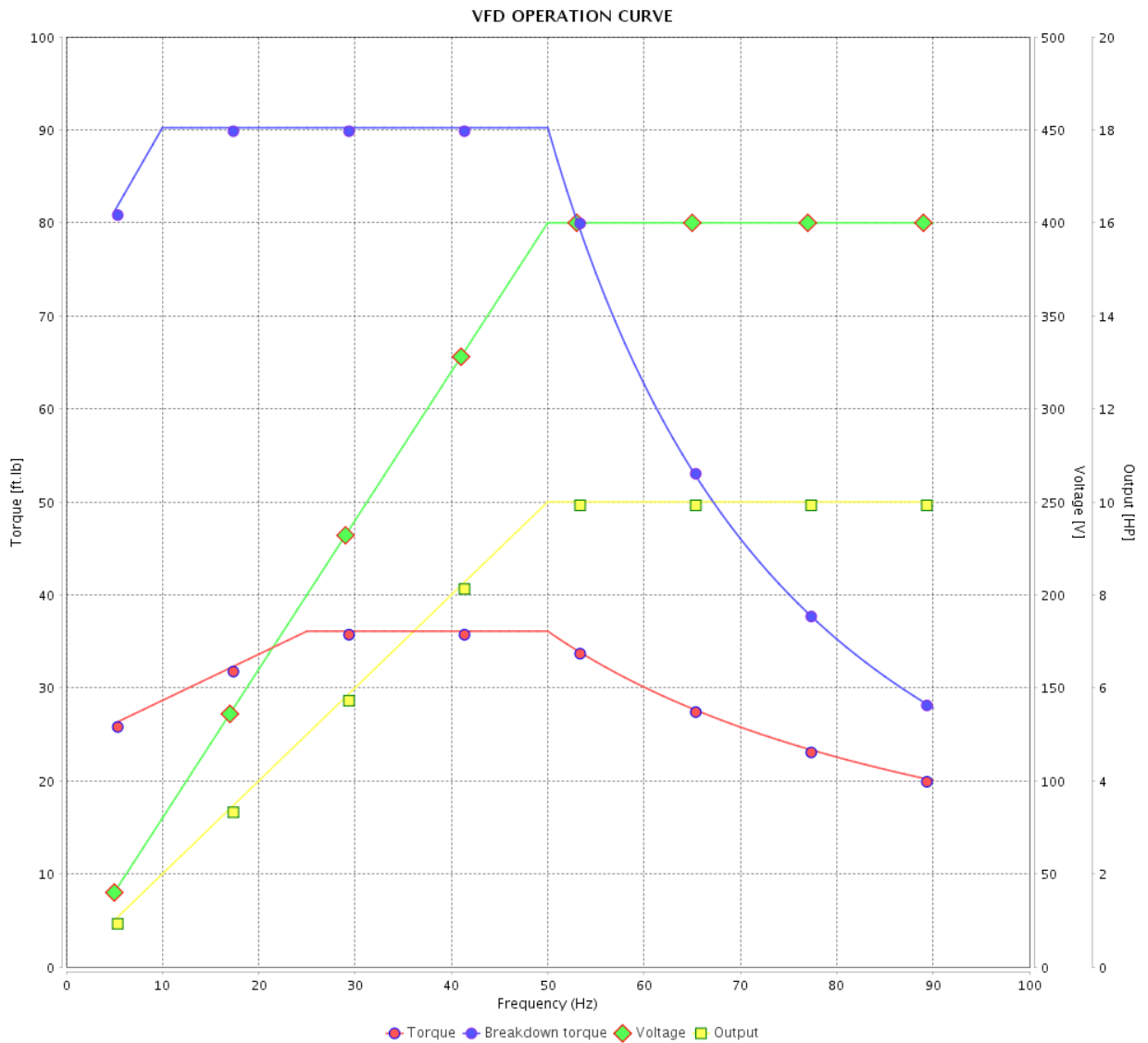

Performance : 400 V 50 Hz 4P IE2

Rated current : 14.2 A
 LRC : 5.6
 Rated torque : 36.1 ft.lb
 Locked rotor torque : 180 %
 Breakdown torque : 250 %
 Rated speed : 1455 rpm

Moment of inertia (J) : 1.51 sq.ft.lb
 Duty cycle : Cont.(S1)
 Insulation class : F
 Service factor : 1.15
 Temperature rise : 80 K
 Design : B

Rev.	Changes Summary	Performed	Checked	Date
Performed by			Page	Revision
Checked by			35 / 36	
Date	12/04/2022			

VFD OPERATION CURVE

Three Phase Induction Motor - Squirrel Cage



Customer :

Product line : NEMA Premium Efficiency Three-Phase

Product code : 11431640

Catalog # : 01018ST3QIE215T-W22

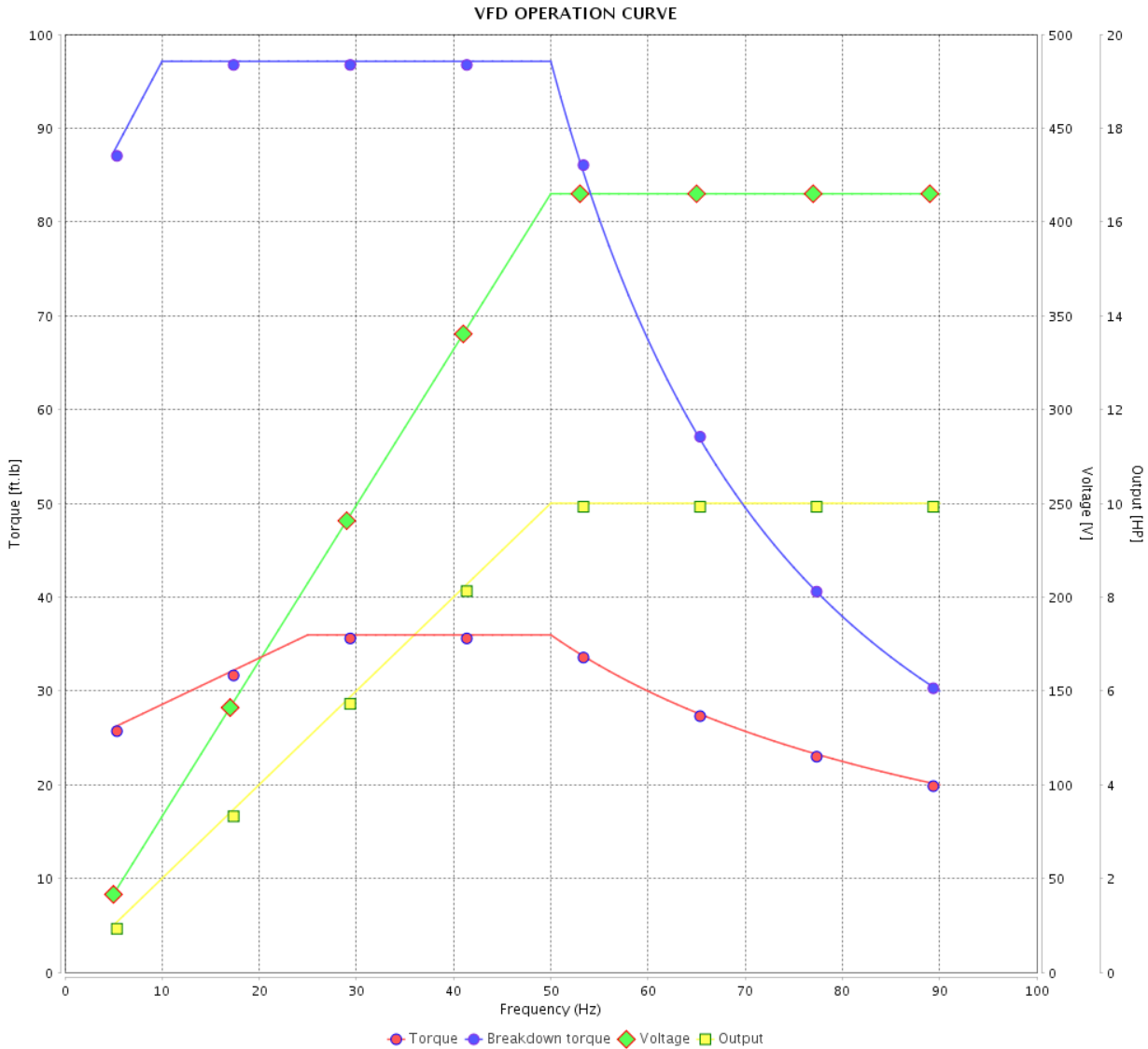

Performance : 415 V 50 Hz 4P IE2

Rated current : 13.8 A
 LRC : 6.0
 Rated torque : 36.0 ft.lb
 Locked rotor torque : 190 %
 Breakdown torque : 270 %
 Rated speed : 1460 rpm

Moment of inertia (J) : 1.51 sq.ft.lb
 Duty cycle : Cont.(S1)
 Insulation class : F
 Service factor : 1.15
 Temperature rise : 80 K
 Design : B

Rev.	Changes Summary	Performed	Checked	Date
Performed by			Page 36 / 36	Revision
Checked by				
Date	12/04/2022			

1 2 3 4 5 6

A

B

C

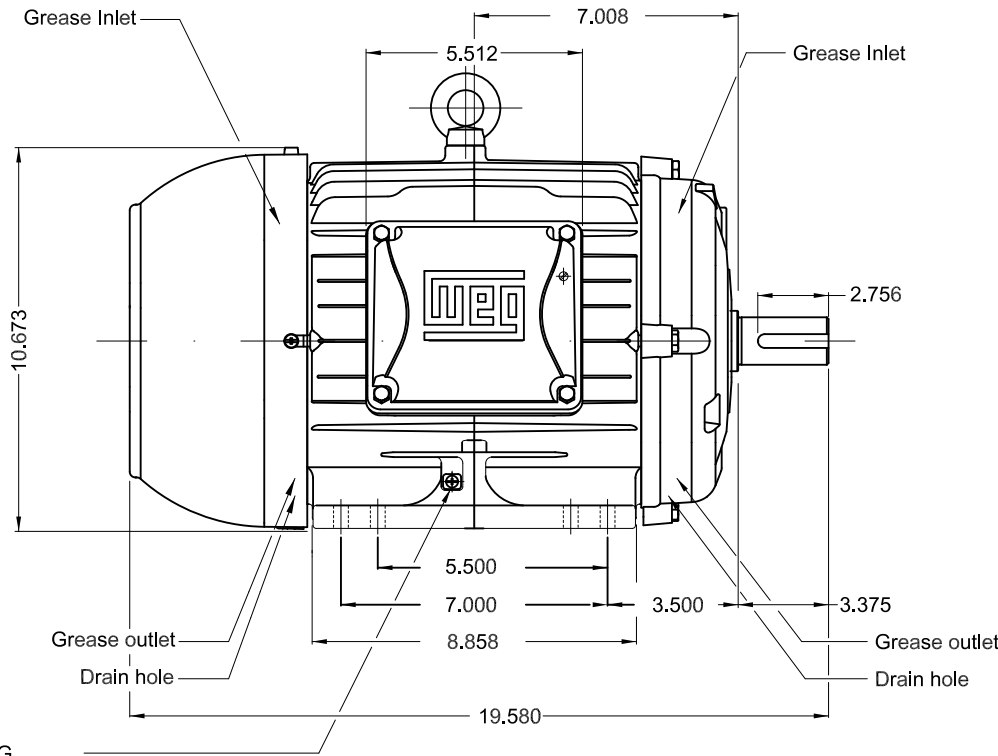
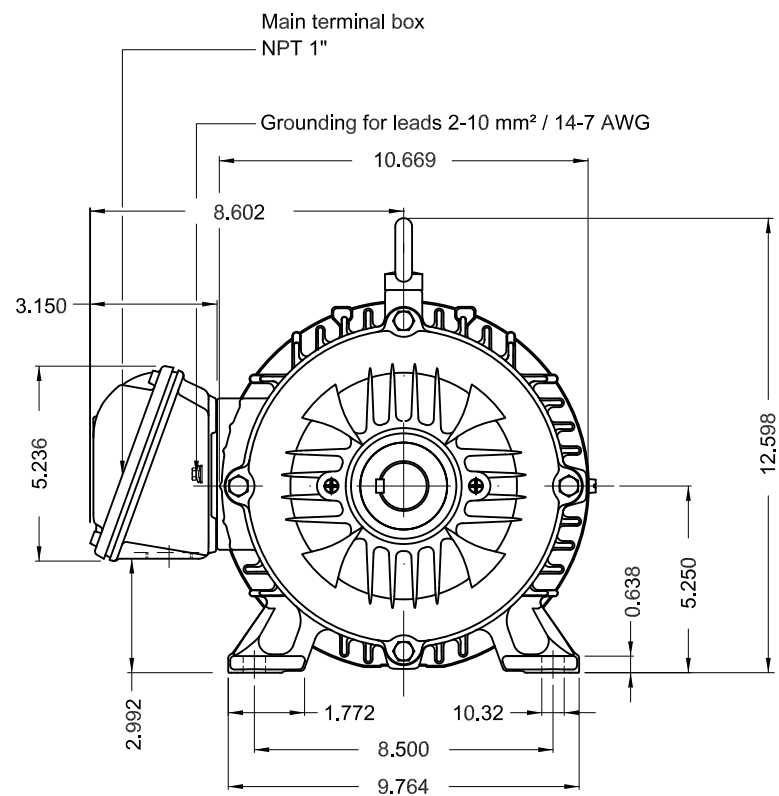

Grounding for leads 2-10 mm² / 14-7 AWG

D

E

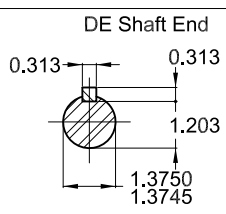

Color RAL 5009
Painting plan 202E
Mounting B3R(D)

10 HP 04 Poles 60 Hz A

ECM	LOC	SUMMARY OF MODIFICATIONS	EXECUTED	CHECKED	RELEASED	DATE	VER
EXECUTED	PIRWBUSER	THREE PH. MOTOR IEEE 841 W22 PREM. EFF.					
CHECKED		FRAME 213/5T IP55 TEFC					
RELEASED							
REL DT.	WMO	Jaragua do Sul	Product Engineering	SHEET	1 / 1		

PREVIEW
WDD



Dimensions in inches XME A3

MADE IN BRAZIL
11431640



NEMA
Premium



Class I, Div 2, Gr A, B, C and D - T3
Class I, Zone 2, IIC - T3
Class II, Div 2, Gr F and G - T4
For use on PWM: Gr. A, B, C, D and F,
VT 1000:1, CT 20:1, 1.00SF - T3A

MODEL 01018ST3QIE215T-W22

Inverter Duty Motor
Severe Duty

IEEE
841-2009



FOR SAFE AREA
Mod. TE1BFOXON
CC029A

PH3 60Hz Fr. 213/5T 1000m.a.s.l. IP55 TEFC 187lb

V 460

A 12.4

HP 10

kW 7.5

SF 1.25

SFA 15.5

RPM 1765

PF 0.83

AMB 40°C

INS cl. F DT80K

NEMA NOM EFF 91.7%

DUTY CONT.

DES B Code H

GUARANT. EFF 90.2%

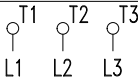

460V



→ 6308-C3 (11g) 40BC03X30

→ 6207-C3 (7g) 35BC02X30

MOBIL POLYREX EM (20000h)

