

# DATA SHEET



## Three Phase Induction Motor - Squirrel Cage

Customer							
Product line	: NEMA Premium Efficiency Three-Phase			Product code :	11431991		
				Catalog # :	01018ST3QIE215TC-W22		
Frame	: 213/5TC			Cooling method	: IC411 - TEFC		
Insulation class	: F			Mounting	: F-1		
Duty cycle	: Cont.(S1)			Rotation <sup>1</sup>	: Both (CW and CCW)		
Ambient temperature	: -20°C to +40°C			Starting method	: Direct On Line		
Altitude	: 1000 m.a.s.l.			Approx. weight <sup>2</sup>	: 191 lb		
Protection degree	: IP55			Moment of inertia (J)	: 1.51 sq.ft.lb		
Design	: B						
Output [HP]	10	7.5	7.5	7.5	10	10	10
Poles	4	4	4	4	4	4	4
Frequency [Hz]	60	50	50	50	50	50	50
Rated voltage [V]	460	380	400	415	380	400	415
Rated current [A]	12.4	11.2	11.0	10.9	15.0	14.2	13.8
L. R. Amperes [A]	79.4	75.0	78.1	81.7	76.5	79.5	82.8
LRC [A]	6.4x(Code H)	6.7x(Code H)	7.1x(Code J)	7.5x(Code J)	5.1x(Code F)	5.6x(Code F)	6.0x(Code G)
No load current [A]	5.65	5.60	6.00	6.35	5.60	6.00	6.35
Rated speed [RPM]	1765	1465	1470	1470	1450	1455	1460
Slip [%]	1.94	2.33	2.00	2.00	3.33	3.00	2.67
Rated torque [ft.lb]	29.8	26.9	26.8	26.8	36.2	36.1	36.0
Locked rotor torque [%]	200	200	240	260	150	180	190
Breakdown torque [%]	295	300	340	360	220	250	270
Service factor	1.25	1.15	1.15	1.15	1.15	1.15	1.15
Temperature rise	80 K	80 K	80 K	80 K	80 K	80 K	80 K
Locked rotor time	30s (cold) 17s (hot)	25s (cold) 14s (hot)	25s (cold) 14s (hot)	25s (cold) 14s (hot)	25s (cold) 14s (hot)	25s (cold) 14s (hot)	25s (cold) 14s (hot)
Noise level <sup>2</sup>	58.0 dB(A)	56.0 dB(A)	56.0 dB(A)	56.0 dB(A)	56.0 dB(A)	56.0 dB(A)	56.0 dB(A)
Efficiency (%)	25%						
	50%	91.0	90.0	89.2	88.7	90.3	90.3
	75%	91.7	90.0	89.9	89.8	90.2	90.2
	100%	91.7	89.8	90.1	90.3	88.5	89.5
Power Factor	25%						
	50%	0.66	0.62	0.58	0.55	0.73	0.69
	75%	0.77	0.76	0.73	0.70	0.82	0.80
	100%	0.83	0.83	0.80	0.78	0.86	0.85
Bearing type	: Drive end 6308 C3 Non drive end 6207 C3		Foundation loads				
Sealing	: Inpro/Seal Inpro/Seal		Max. traction : 452 lb				
Lubrication interval	: 20000 h 20000 h		Max. compression : 643 lb				
Lubricant amount	: 11 g 7 g						
Lubricant type	: Mobil Polyrex EM						
Notes							
This revision replaces and cancel the previous one, which must be eliminated. (1) Looking the motor from the shaft end. (2) Measured at 1m and with tolerance of +3dB(A). (3) Approximate weight subject to changes after manufacturing process. (4) At 100% of full load.				These are average values based on tests with sinusoidal power supply, subject to the tolerances stipulated in NEMA MG-1.			
Rev.	Changes Summary			Performed	Checked	Date	
Performed by							
Checked by					Page	Revision	
Date	01/06/2022				1 / 36		

# TORQUE AND CURRENT VS SPEED CURVE

Three Phase Induction Motor - Squirrel Cage



Customer :

Product line : NEMA Premium Efficiency Three-Phase

Product code : 11431991

Catalog # : 01018ST3QIE215TC-W22

TORQUE AND CURRENT VS SPEED CURVE

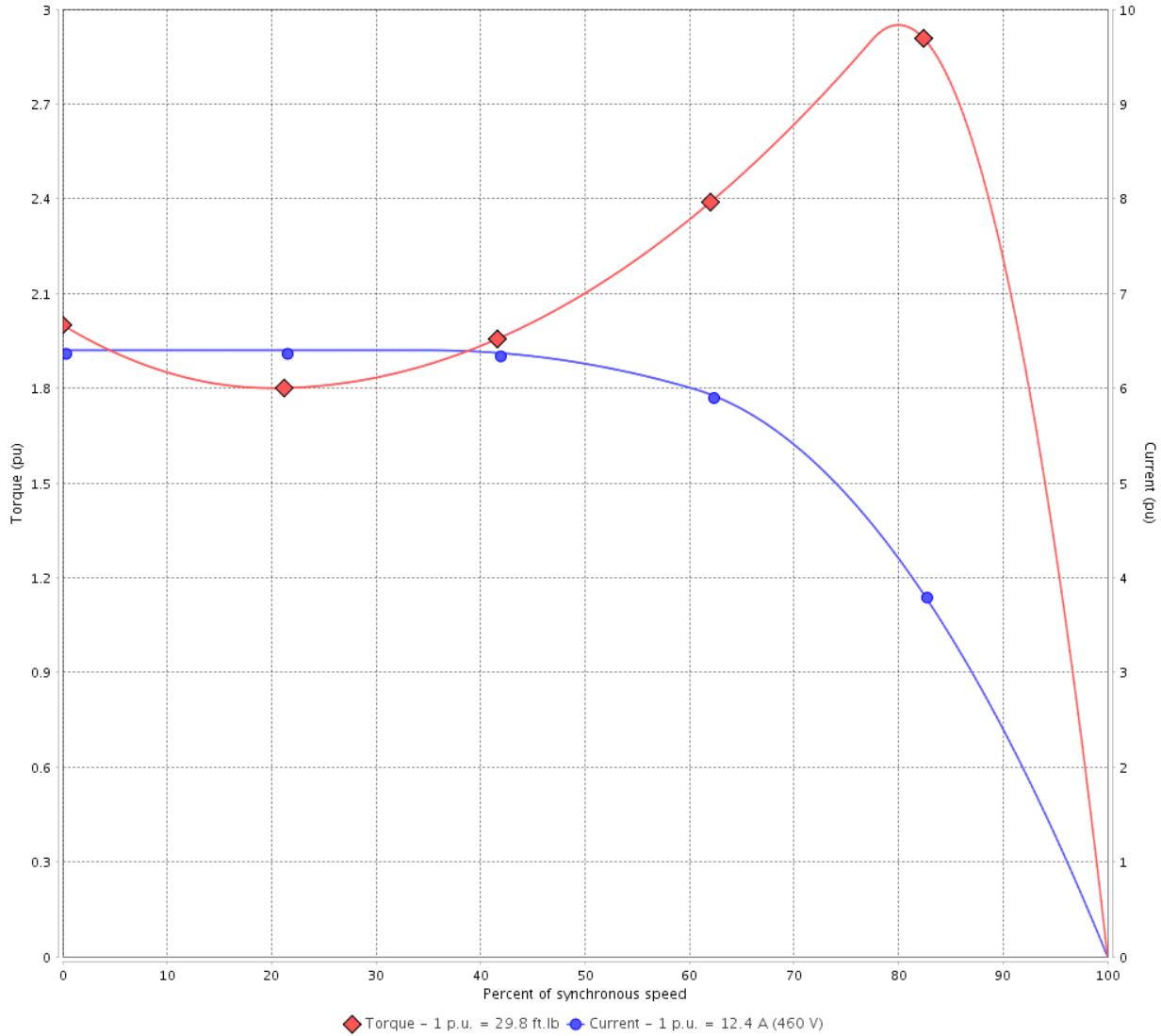

Performance : 460 V 60 Hz 4P

Rated current	: 12.4 A	Moment of inertia (J)	: 1.51 sq.ft.lb
LRC	: 6.4	Duty cycle	: Cont.(S1)
Rated torque	: 29.8 ft.lb	Insulation class	: F
Locked rotor torque	: 200 %	Service factor	: 1.25
Breakdown torque	: 295 %	Temperature rise	: 80 K
Rated speed	: 1765 rpm	Design	: B

Locked rotor time : 30s (cold) 17s (hot)

Rev.	Changes Summary	Performed	Checked	Date
Performed by			Page 2 / 36	Revision
Checked by				
Date	01/06/2022			

# TORQUE AND CURRENT VS SPEED CURVE



## Three Phase Induction Motor - Squirrel Cage

Customer :

Product line : NEMA Premium Efficiency Three-Phase

Product code : 11431991

Catalog # : 01018ST3QIE215TC-W22

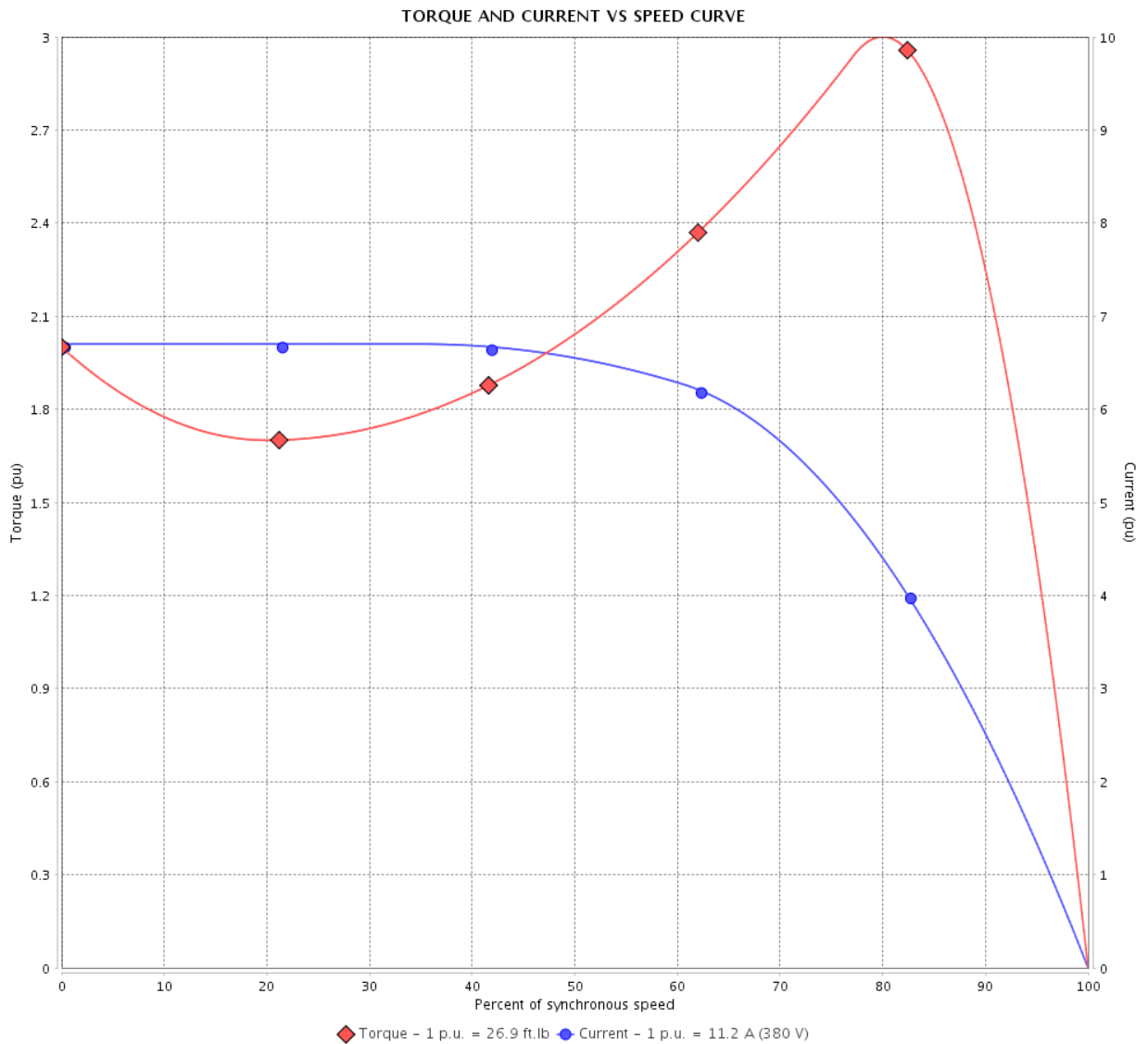

Performance : 380 V 50 Hz 4P IE3

Rated current : 11.2 A  
 LRC : 6.7  
 Rated torque : 26.9 ft.lb  
 Locked rotor torque : 200 %  
 Breakdown torque : 300 %  
 Rated speed : 1465 rpm

Moment of inertia (J) : 1.51 sq.ft.lb  
 Duty cycle : Cont.(S1)  
 Insulation class : F  
 Service factor : 1.15  
 Temperature rise : 80 K  
 Design : B

Locked rotor time : 25s (cold) 14s (hot)

Rev.	Changes Summary	Performed	Checked	Date
Performed by			Page 3 / 36	Revision
Checked by				
Date	01/06/2022			

# TORQUE AND CURRENT VS SPEED CURVE

## Three Phase Induction Motor - Squirrel Cage



Customer :

Product line : NEMA Premium Efficiency Three-Phase

Product code : 11431991

Catalog # : 01018ST3QIE215TC-W22

TORQUE AND CURRENT VS SPEED CURVE

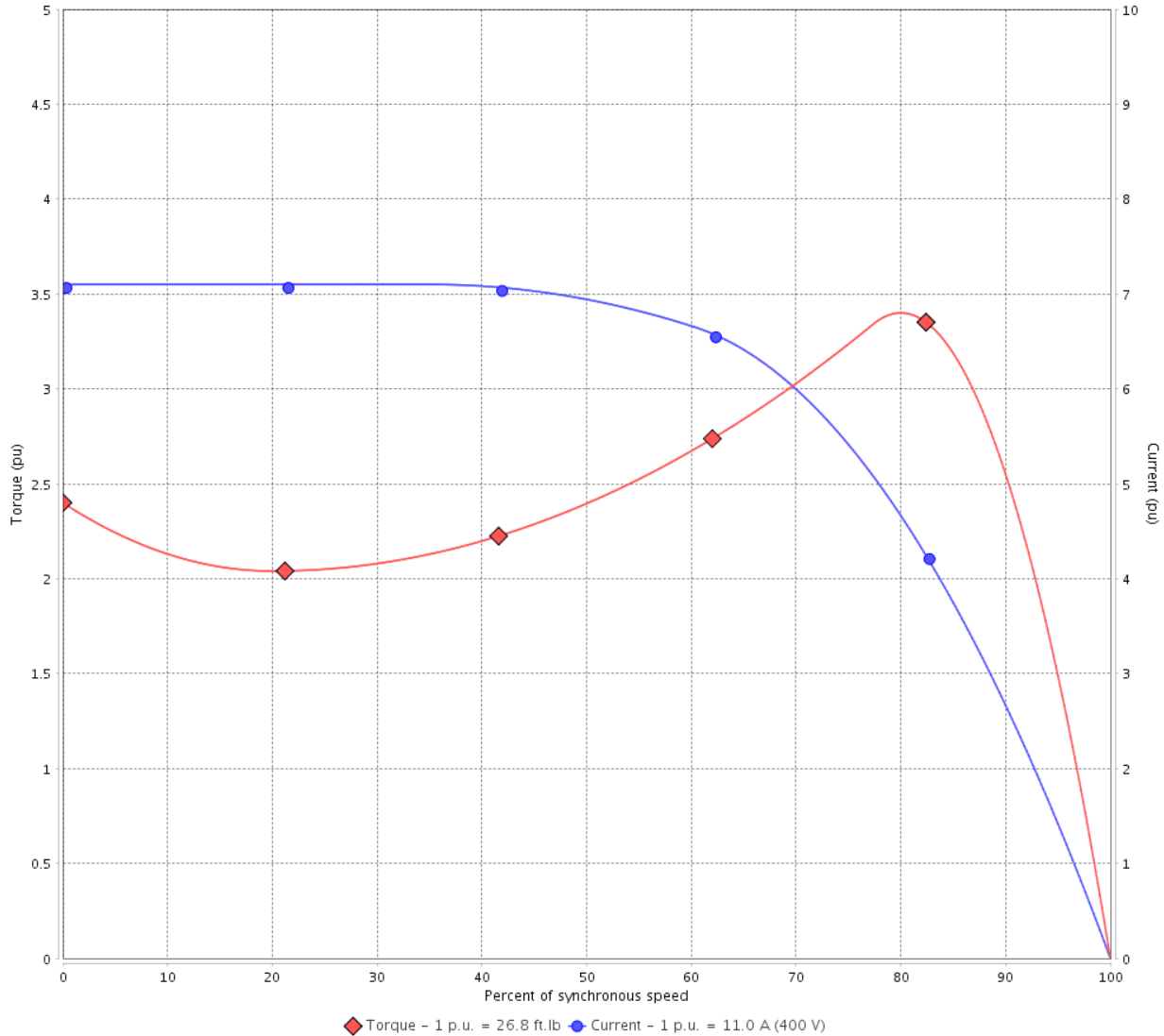

Performance : 400 V 50 Hz 4P IE3

Rated current	: 11.0 A	Moment of inertia (J)	: 1.51 sq.ft.lb
LRC	: 7.1	Duty cycle	: Cont.(S1)
Rated torque	: 26.8 ft.lb	Insulation class	: F
Locked rotor torque	: 240 %	Service factor	: 1.15
Breakdown torque	: 340 %	Temperature rise	: 80 K
Rated speed	: 1470 rpm	Design	: B

Locked rotor time : 25s (cold) 14s (hot)

Rev.	Changes Summary	Performed	Checked	Date
Performed by			Page 4 / 36	Revision
Checked by				
Date	01/06/2022			

# TORQUE AND CURRENT VS SPEED CURVE



## Three Phase Induction Motor - Squirrel Cage

Customer :

Product line : NEMA Premium Efficiency Three-Phase

Product code : 11431991

Catalog # : 01018ST3QIE215TC-W22

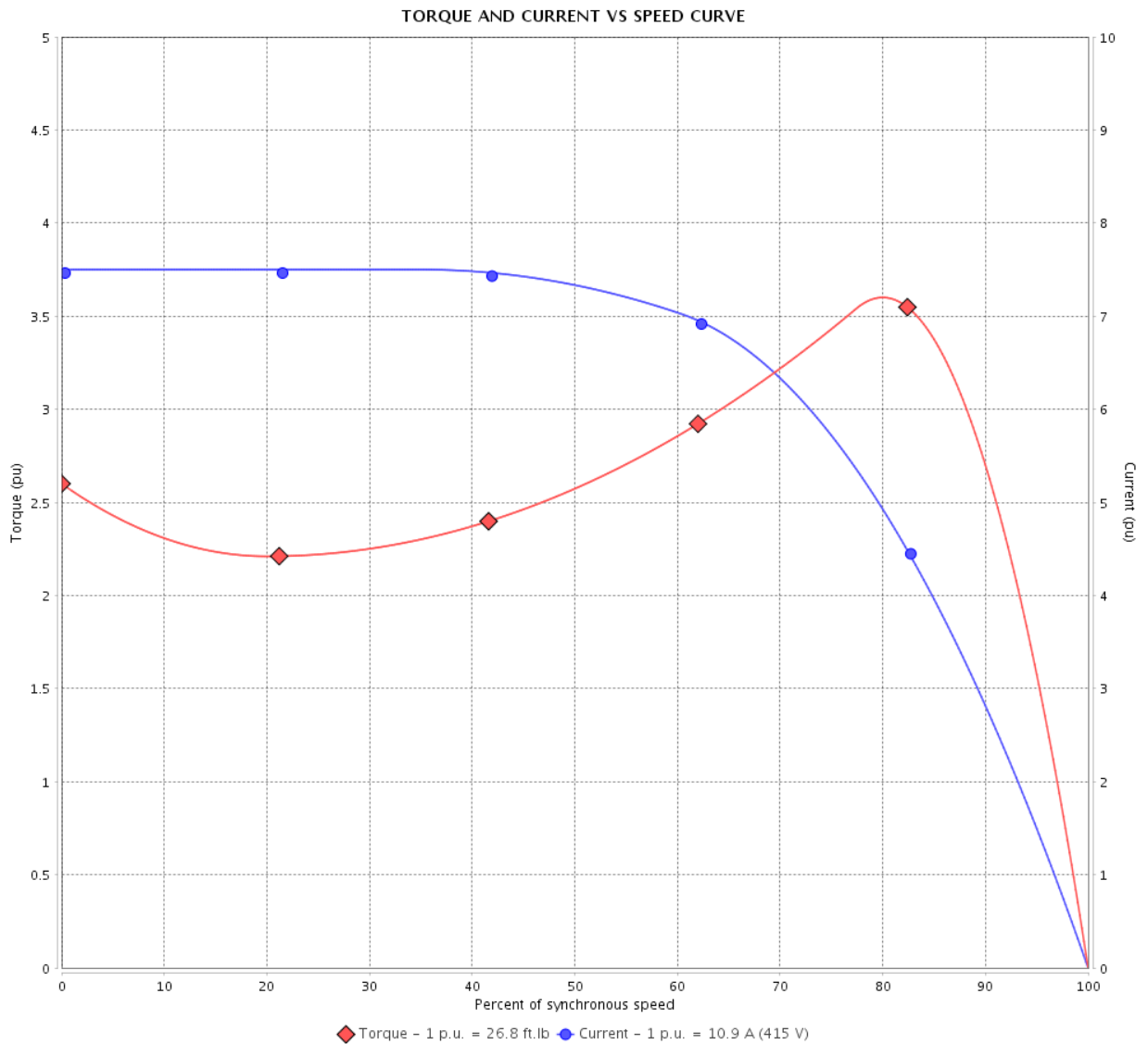

Performance : 415 V 50 Hz 4P IE3

Rated current : 10.9 A  
 LRC : 7.5  
 Rated torque : 26.8 ft.lb  
 Locked rotor torque : 260 %  
 Breakdown torque : 360 %  
 Rated speed : 1470 rpm

Moment of inertia (J) : 1.51 sq.ft.lb  
 Duty cycle : Cont.(S1)  
 Insulation class : F  
 Service factor : 1.15  
 Temperature rise : 80 K  
 Design : B

Locked rotor time : 25s (cold) 14s (hot)

Rev.	Changes Summary	Performed	Checked	Date
Performed by		Page		Revision
Checked by		5 / 36		
Date	01/06/2022			

# TORQUE AND CURRENT VS SPEED CURVE

## Three Phase Induction Motor - Squirrel Cage



Customer :

Product line : NEMA Premium Efficiency Three-Phase

Product code : 11431991

Catalog # : 01018ST3QIE215TC-W22

TORQUE AND CURRENT VS SPEED CURVE

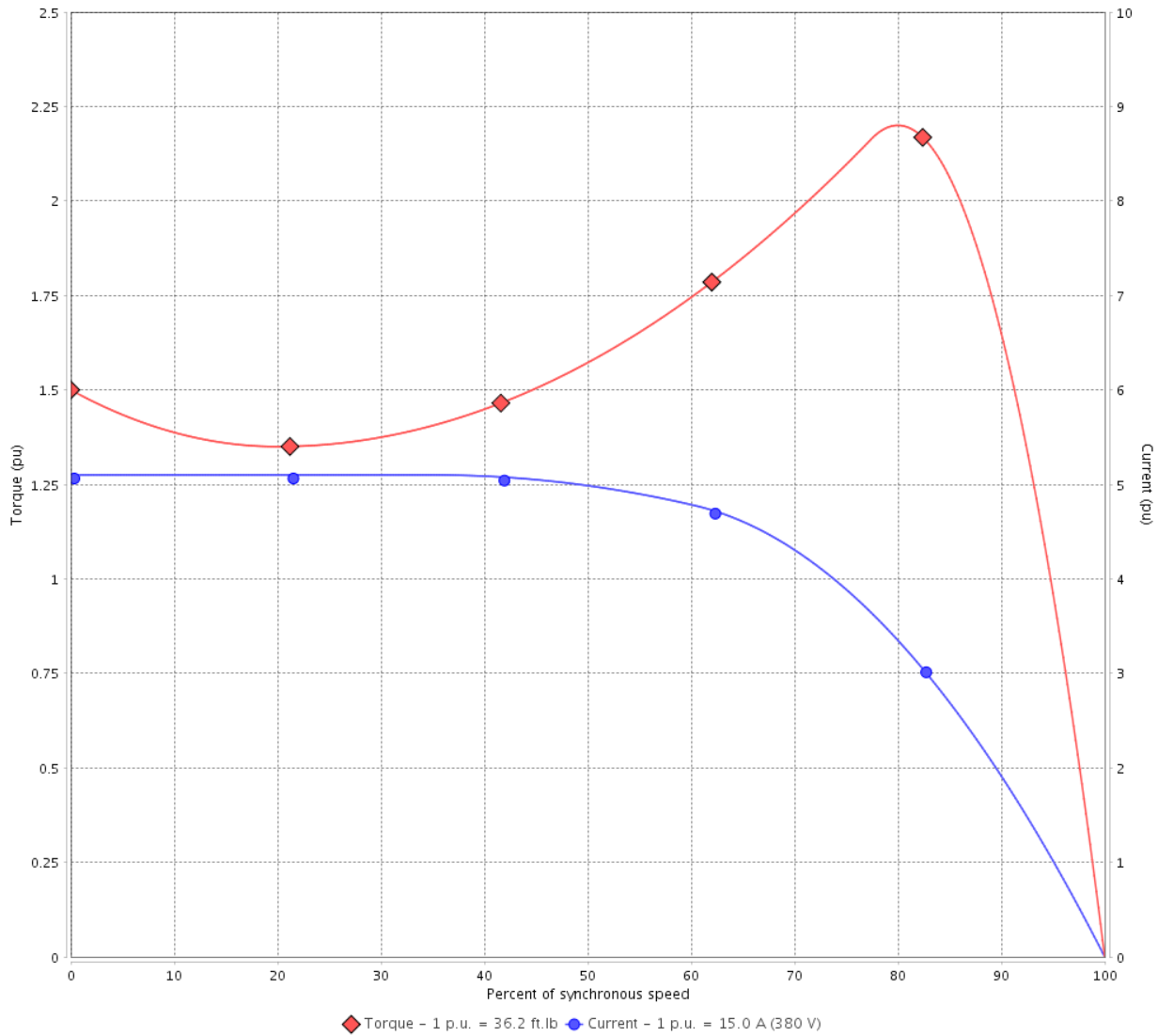

Performance : 380 V 50 Hz 4P IE1

Rated current	: 15.0 A	Moment of inertia (J)	: 1.51 sq.ft.lb
LRC	: 5.1	Duty cycle	: Cont.(S1)
Rated torque	: 36.2 ft.lb	Insulation class	: F
Locked rotor torque	: 150 %	Service factor	: 1.15
Breakdown torque	: 220 %	Temperature rise	: 80 K
Rated speed	: 1450 rpm	Design	: B

Locked rotor time : 25s (cold) 14s (hot)

Rev.	Changes Summary	Performed	Checked	Date
Performed by			Page 6 / 36	Revision
Checked by				
Date	01/06/2022			

# TORQUE AND CURRENT VS SPEED CURVE



## Three Phase Induction Motor - Squirrel Cage

Customer :

Product line : NEMA Premium Efficiency Three-Phase

Product code : 11431991

Catalog # : 01018ST3QIE215TC-W22

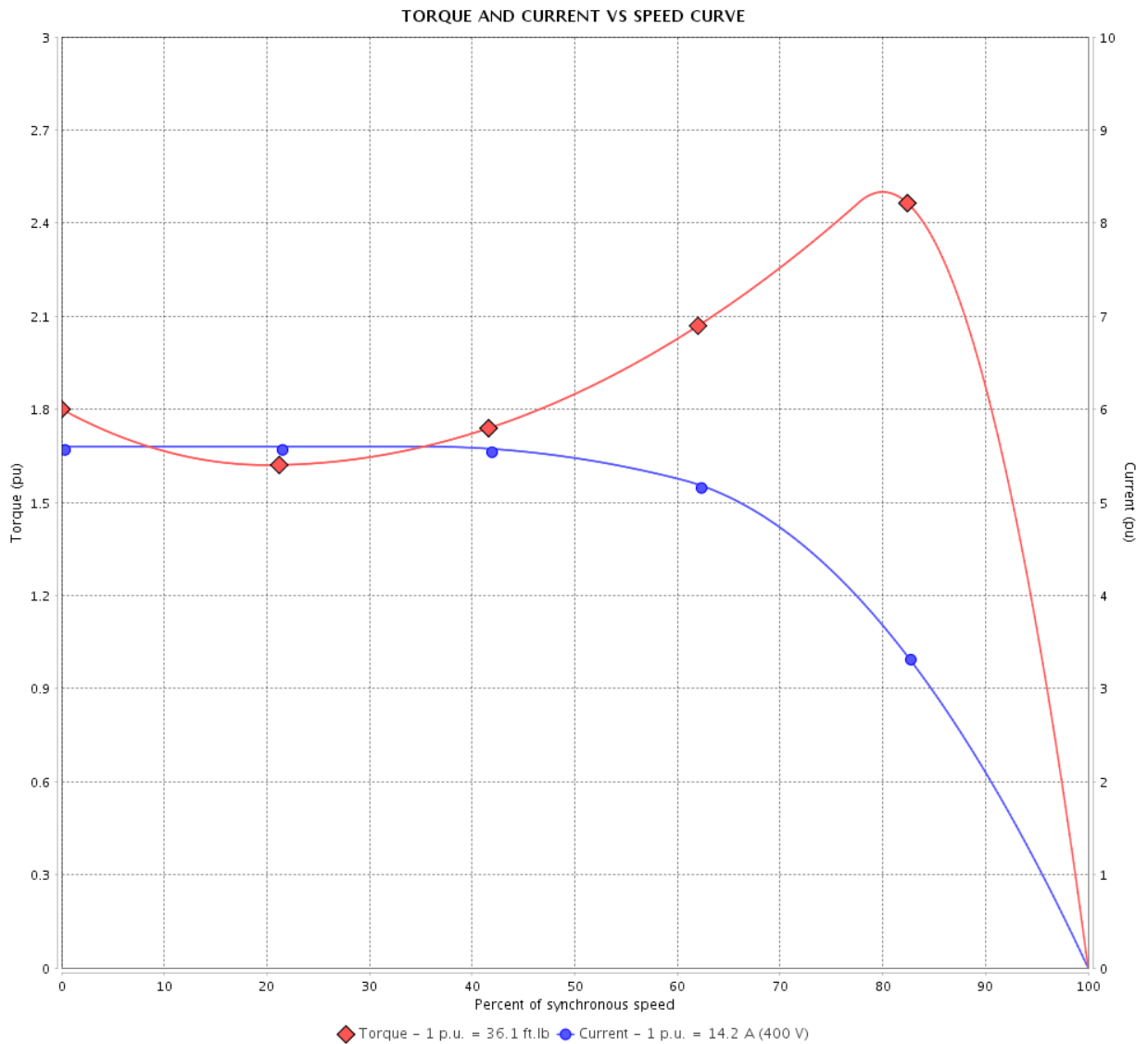

Performance : 400 V 50 Hz 4P IE2

Rated current	: 14.2 A	Moment of inertia (J)	: 1.51 sq.ft.lb
LRC	: 5.6	Duty cycle	: Cont.(S1)
Rated torque	: 36.1 ft.lb	Insulation class	: F
Locked rotor torque	: 180 %	Service factor	: 1.15
Breakdown torque	: 250 %	Temperature rise	: 80 K
Rated speed	: 1455 rpm	Design	: B

Locked rotor time : 25s (cold) 14s (hot)

Rev.	Changes Summary	Performed	Checked	Date
Performed by			Page 7 / 36	Revision
Checked by				
Date	01/06/2022			

# TORQUE AND CURRENT VS SPEED CURVE

## Three Phase Induction Motor - Squirrel Cage



Customer :

Product line : NEMA Premium Efficiency Three-Phase

Product code : 11431991

Catalog # : 01018ST3QIE215TC-W22

TORQUE AND CURRENT VS SPEED CURVE

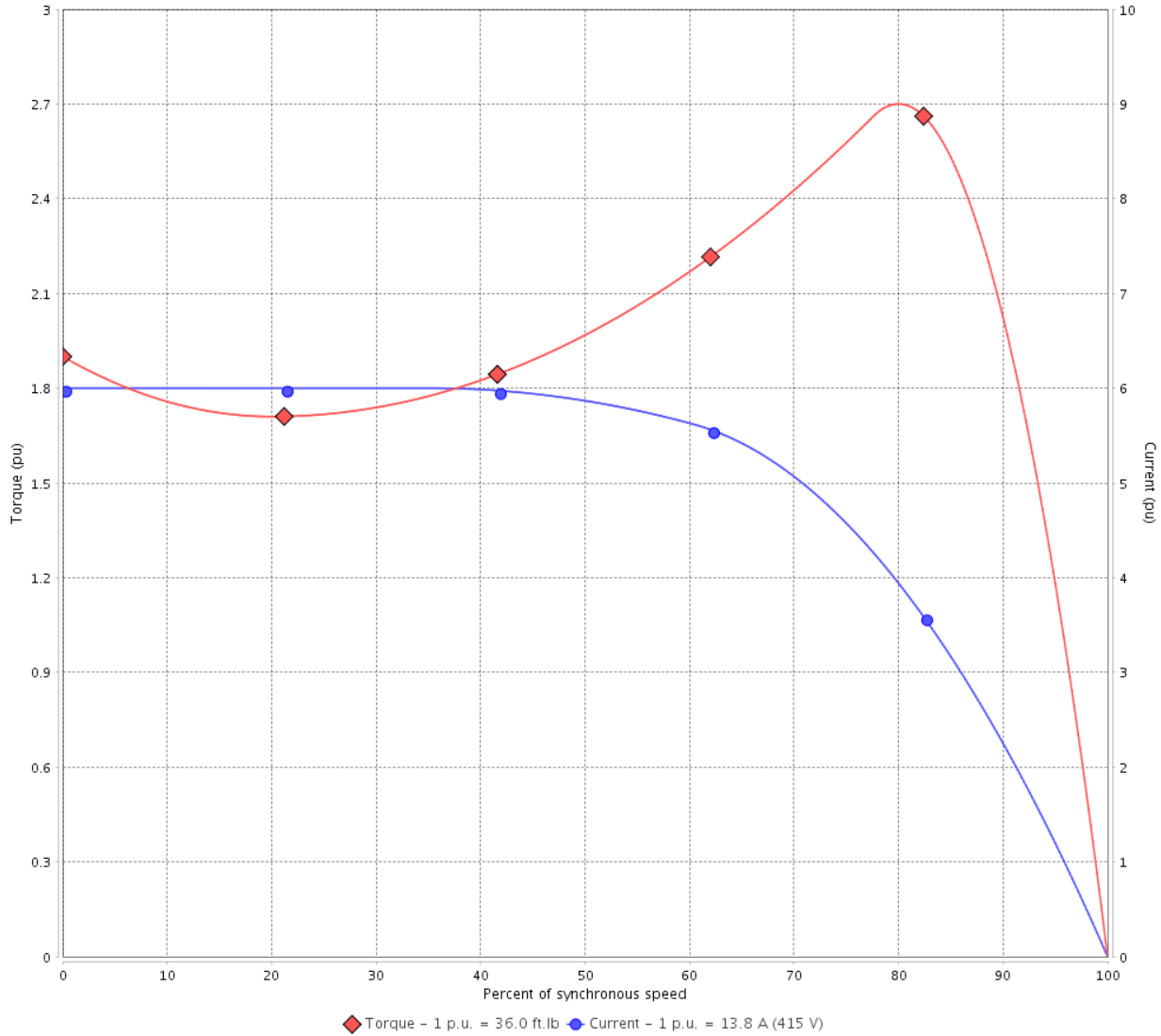

Performance : 415 V 50 Hz 4P IE2

Rated current	: 13.8 A	Moment of inertia (J)	: 1.51 sq.ft.lb
LRC	: 6.0	Duty cycle	: Cont.(S1)
Rated torque	: 36.0 ft.lb	Insulation class	: F
Locked rotor torque	: 190 %	Service factor	: 1.15
Breakdown torque	: 270 %	Temperature rise	: 80 K
Rated speed	: 1460 rpm	Design	: B

Locked rotor time : 25s (cold) 14s (hot)

Rev.	Changes Summary	Performed	Checked	Date
Performed by			Page 8 / 36	Revision
Checked by				
Date	01/06/2022			



# LOAD PERFORMANCE CURVE

## Three Phase Induction Motor - Squirrel Cage



Customer : \_\_\_\_\_

Product line : NEMA Premium Efficiency Three-Phase

Product code : 11431991

Catalog # : 01018ST3QIE215TC-W22

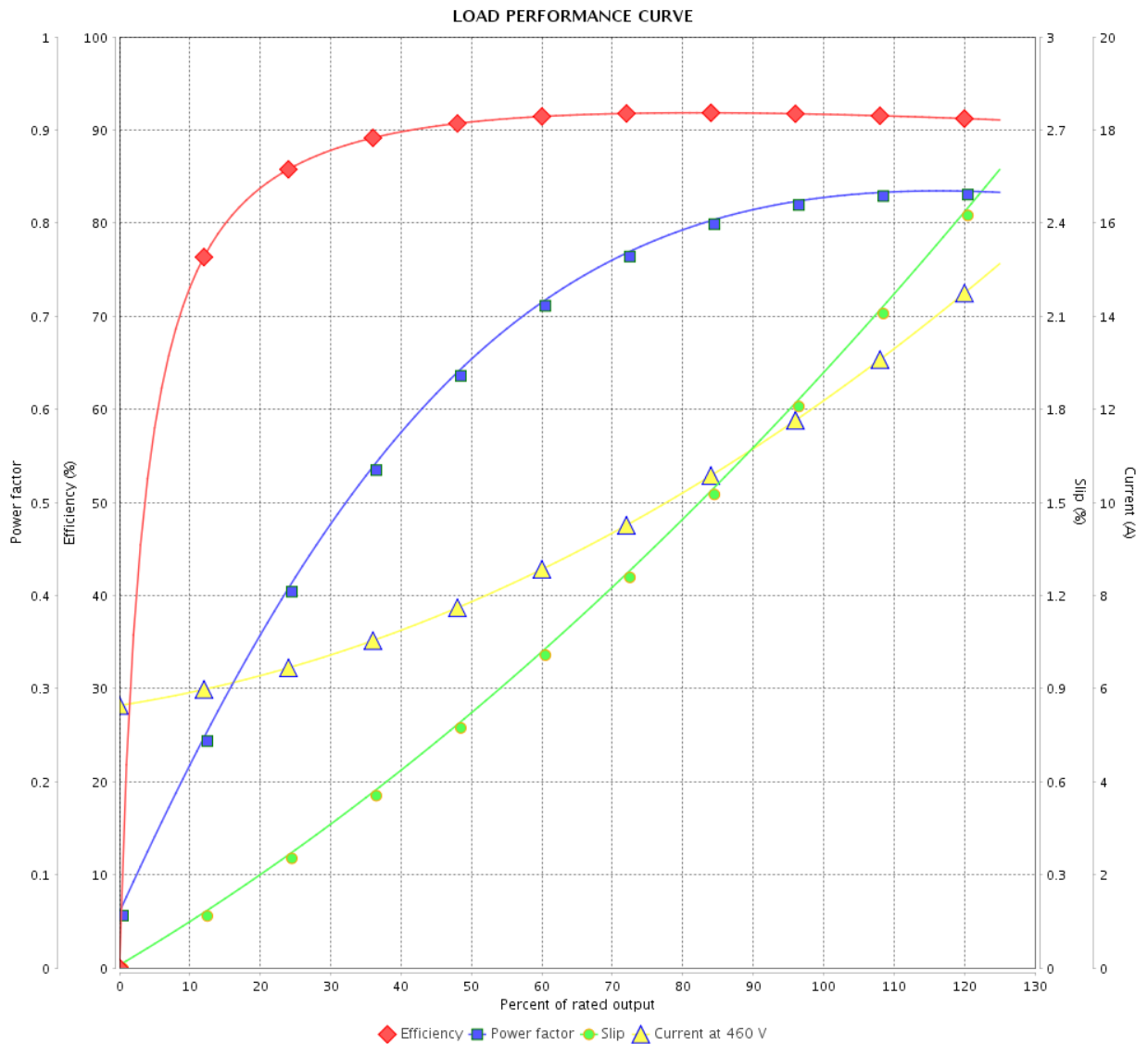

Performance : 460 V 60 Hz 4P

Rated current : 12.4 A  
 LRC : 6.4  
 Rated torque : 29.8 ft.lb  
 Locked rotor torque : 200 %  
 Breakdown torque : 295 %  
 Rated speed : 1765 rpm

Moment of inertia (J) : 1.51 sq.ft.lb  
 Duty cycle : Cont.(S1)  
 Insulation class : F  
 Service factor : 1.25  
 Temperature rise : 80 K  
 Design : B

Rev.	Changes Summary	Performed	Checked	Date
Performed by		Page		Revision
Checked by		9 / 36		
Date		01/06/2022		

# LOAD PERFORMANCE CURVE

Three Phase Induction Motor - Squirrel Cage



Customer :

Product line : NEMA Premium Efficiency Three-Phase

Product code : 11431991

Catalog # : 01018ST3QIE215TC-W22

LOAD PERFORMANCE CURVE

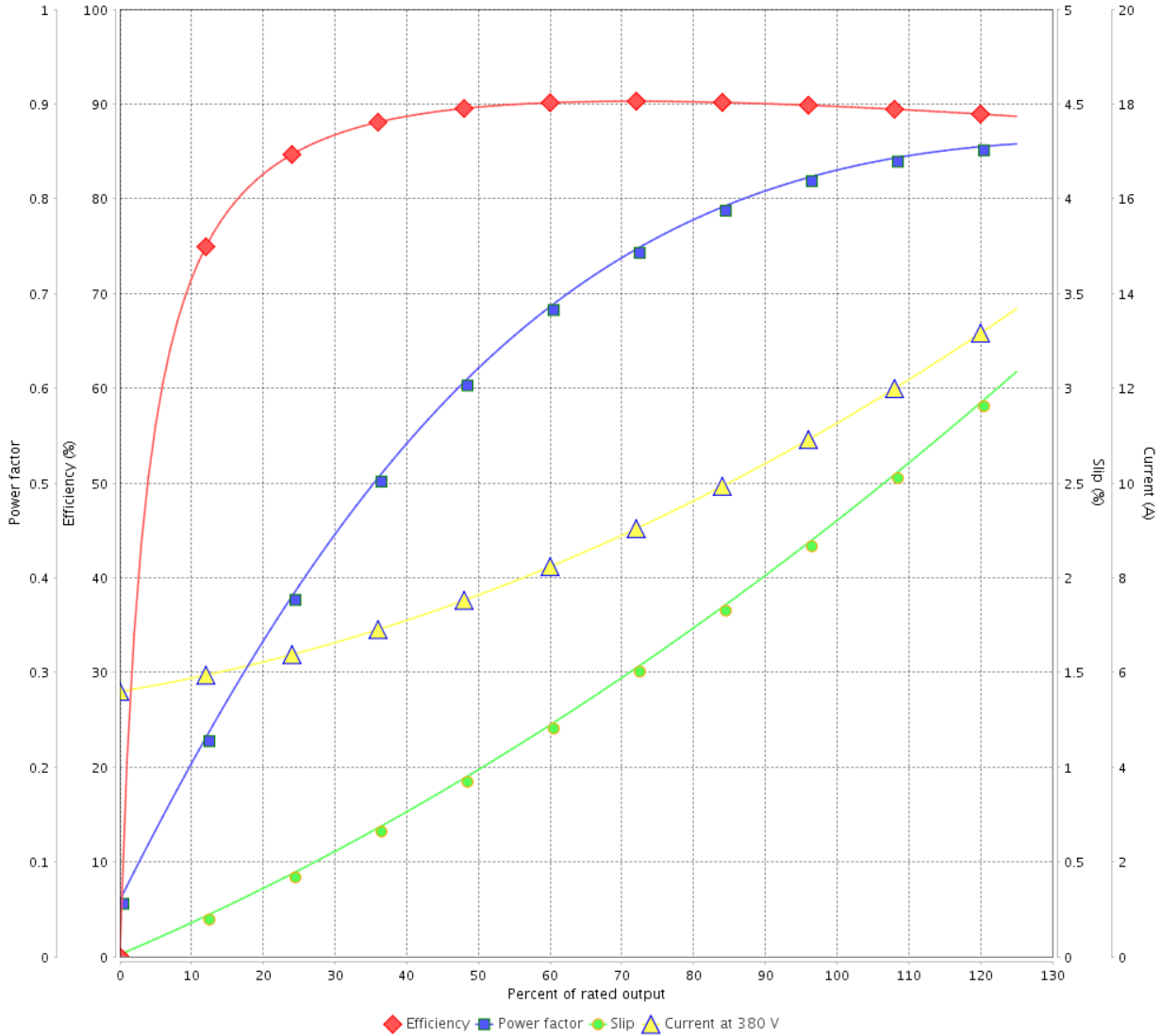

Performance : 380 V 50 Hz 4P IE3

Rated current : 11.2 A  
 LRC : 6.7  
 Rated torque : 26.9 ft.lb  
 Locked rotor torque : 200 %  
 Breakdown torque : 300 %  
 Rated speed : 1465 rpm

Moment of inertia (J) : 1.51 sq.ft.lb  
 Duty cycle : Cont.(S1)  
 Insulation class : F  
 Service factor : 1.15  
 Temperature rise : 80 K  
 Design : B

Rev.	Changes Summary	Performed	Checked	Date
Performed by			Page 10 / 36	Revision
Checked by				
Date	01/06/2022			

# LOAD PERFORMANCE CURVE

## Three Phase Induction Motor - Squirrel Cage



Customer : \_\_\_\_\_

Product line : NEMA Premium Efficiency Three-Phase

Product code : 11431991

Catalog # : 01018ST3QIE215TC-W22

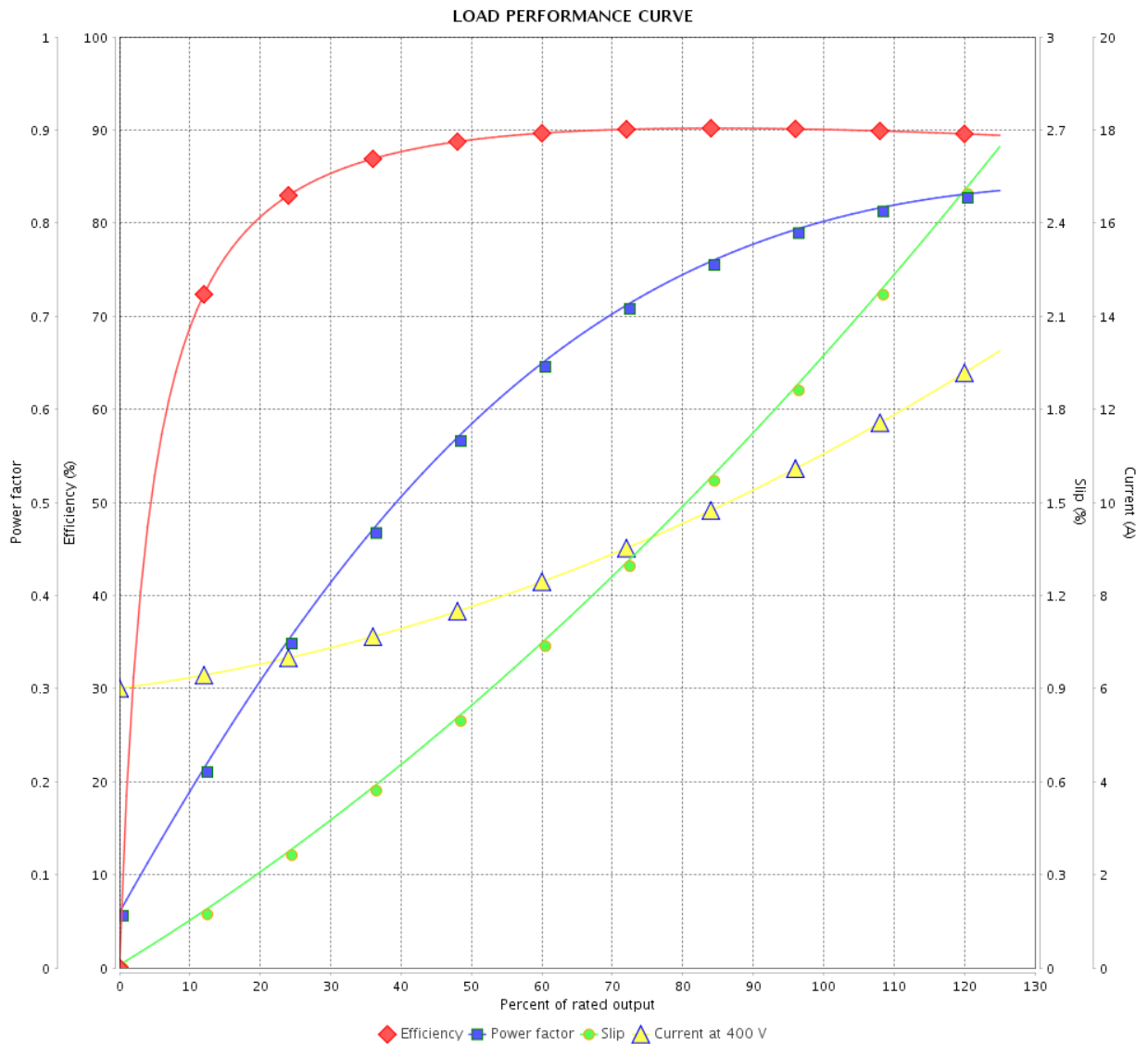

Performance : 400 V 50 Hz 4P IE3

Rated current : 11.0 A  
 LRC : 7.1  
 Rated torque : 26.8 ft.lb  
 Locked rotor torque : 240 %  
 Breakdown torque : 340 %  
 Rated speed : 1470 rpm

Moment of inertia (J) : 1.51 sq.ft.lb  
 Duty cycle : Cont.(S1)  
 Insulation class : F  
 Service factor : 1.15  
 Temperature rise : 80 K  
 Design : B

Rev.	Changes Summary	Performed	Checked	Date
Performed by		Page		Revision
Checked by		11 / 36		
Date		01/06/2022		

# LOAD PERFORMANCE CURVE

Three Phase Induction Motor - Squirrel Cage



Customer :

Product line : NEMA Premium Efficiency Three-Phase

Product code : 11431991

Catalog # : 01018ST3QIE215TC-W22

LOAD PERFORMANCE CURVE

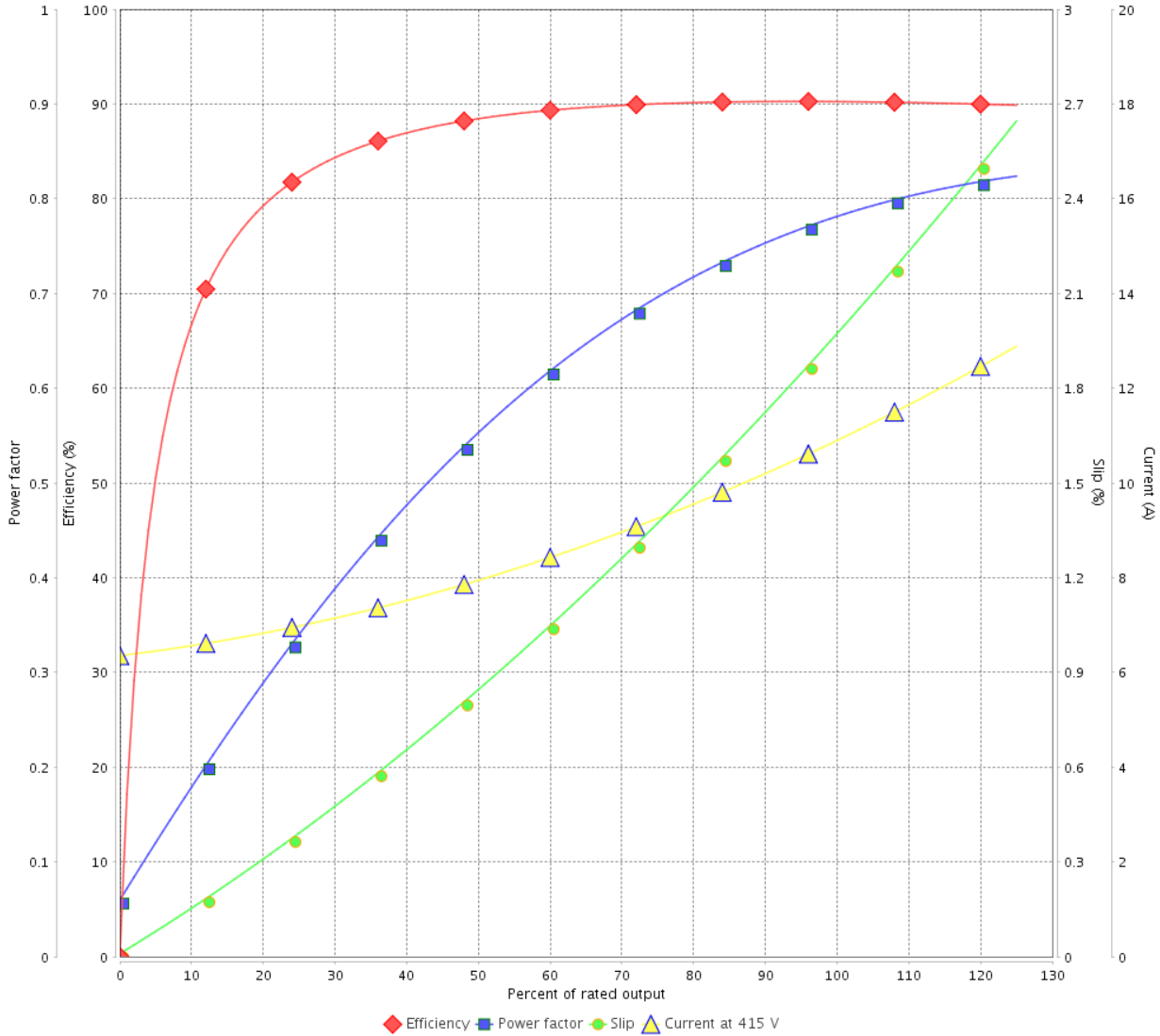

Performance : 415 V 50 Hz 4P IE3

Rated current : 10.9 A  
 LRC : 7.5  
 Rated torque : 26.8 ft.lb  
 Locked rotor torque : 260 %  
 Breakdown torque : 360 %  
 Rated speed : 1470 rpm

Moment of inertia (J) : 1.51 sq.ft.lb  
 Duty cycle : Cont.(S1)  
 Insulation class : F  
 Service factor : 1.15  
 Temperature rise : 80 K  
 Design : B

Rev.	Changes Summary	Performed	Checked	Date
Performed by			Page 12 / 36	Revision
Checked by				
Date	01/06/2022			

# LOAD PERFORMANCE CURVE

Three Phase Induction Motor - Squirrel Cage



Customer :

Product line : NEMA Premium Efficiency Three-Phase

Product code : 11431991

Catalog # : 01018ST3QIE215TC-W22

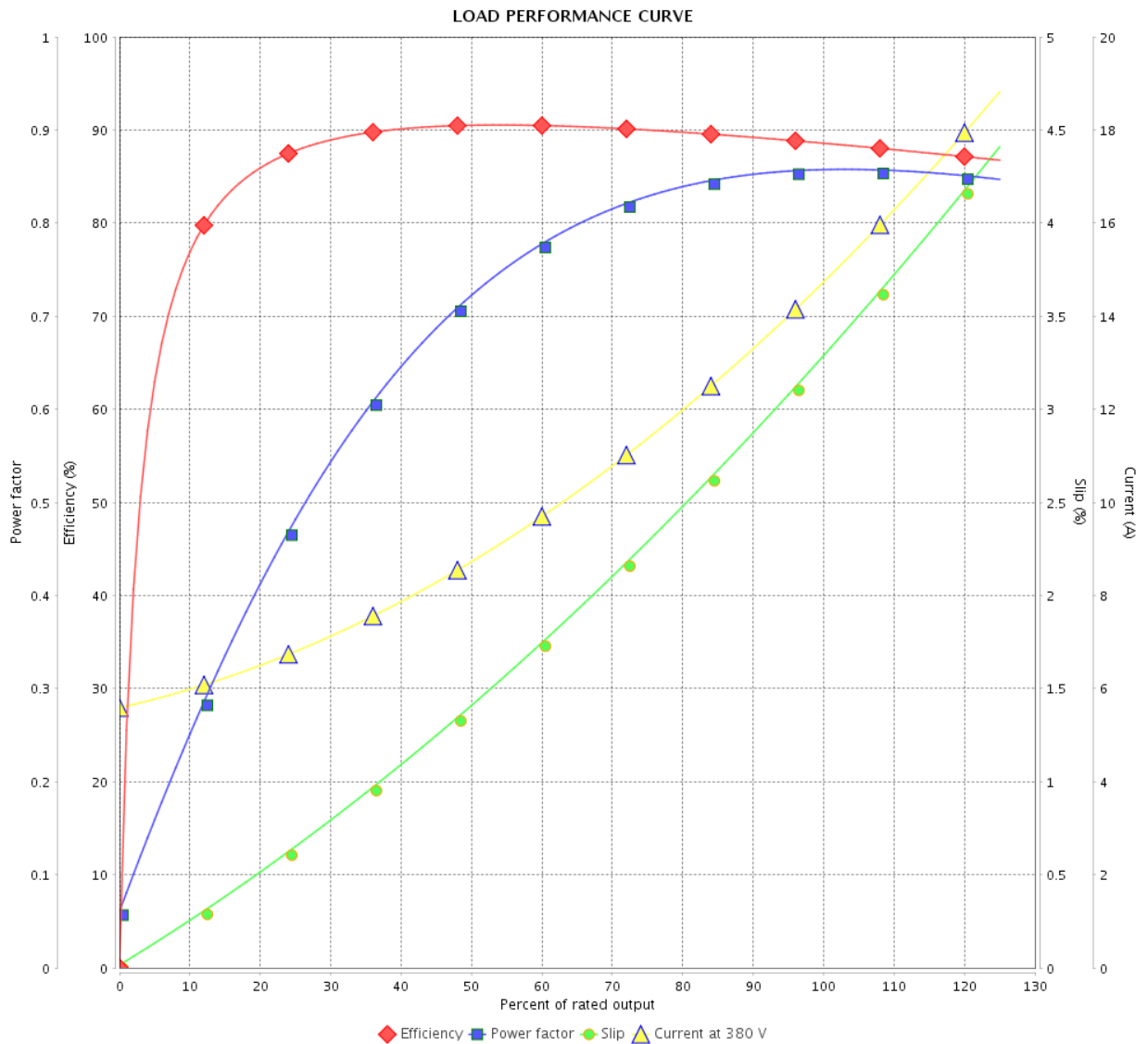

Performance : 380 V 50 Hz 4P IE1

Rated current : 15.0 A  
 LRC : 5.1  
 Rated torque : 36.2 ft.lb  
 Locked rotor torque : 150 %  
 Breakdown torque : 220 %  
 Rated speed : 1450 rpm

Moment of inertia (J) : 1.51 sq.ft.lb  
 Duty cycle : Cont.(S1)  
 Insulation class : F  
 Service factor : 1.15  
 Temperature rise : 80 K  
 Design : B

Rev.	Changes Summary	Performed	Checked	Date
Performed by		Page		Revision
Checked by		13 / 36		
Date		01/06/2022		

# LOAD PERFORMANCE CURVE

Three Phase Induction Motor - Squirrel Cage



Customer :

Product line : NEMA Premium Efficiency Three-Phase

Product code : 11431991

Catalog # : 01018ST3QIE215TC-W22

LOAD PERFORMANCE CURVE

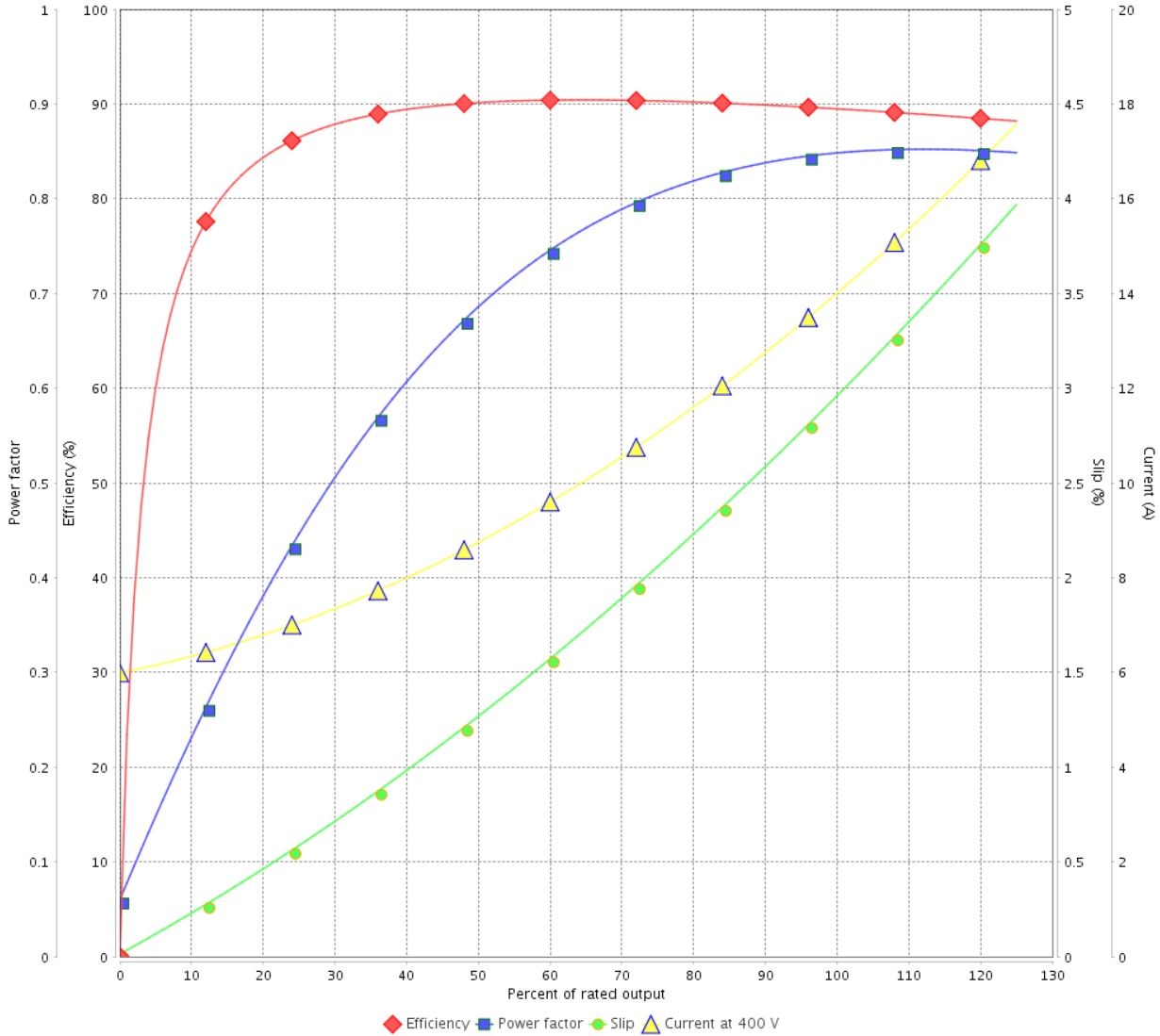

Performance : 400 V 50 Hz 4P IE2

Rated current : 14.2 A  
 LRC : 5.6  
 Rated torque : 36.1 ft.lb  
 Locked rotor torque : 180 %  
 Breakdown torque : 250 %  
 Rated speed : 1455 rpm

Moment of inertia (J) : 1.51 sq.ft.lb  
 Duty cycle : Cont.(S1)  
 Insulation class : F  
 Service factor : 1.15  
 Temperature rise : 80 K  
 Design : B

Rev.	Changes Summary	Performed	Checked	Date
Performed by			Page 14 / 36	Revision
Checked by				
Date	01/06/2022			

# LOAD PERFORMANCE CURVE

## Three Phase Induction Motor - Squirrel Cage



Customer : \_\_\_\_\_

Product line : NEMA Premium Efficiency Three-Phase

Product code : 11431991

Catalog # : 01018ST3QIE215TC-W22

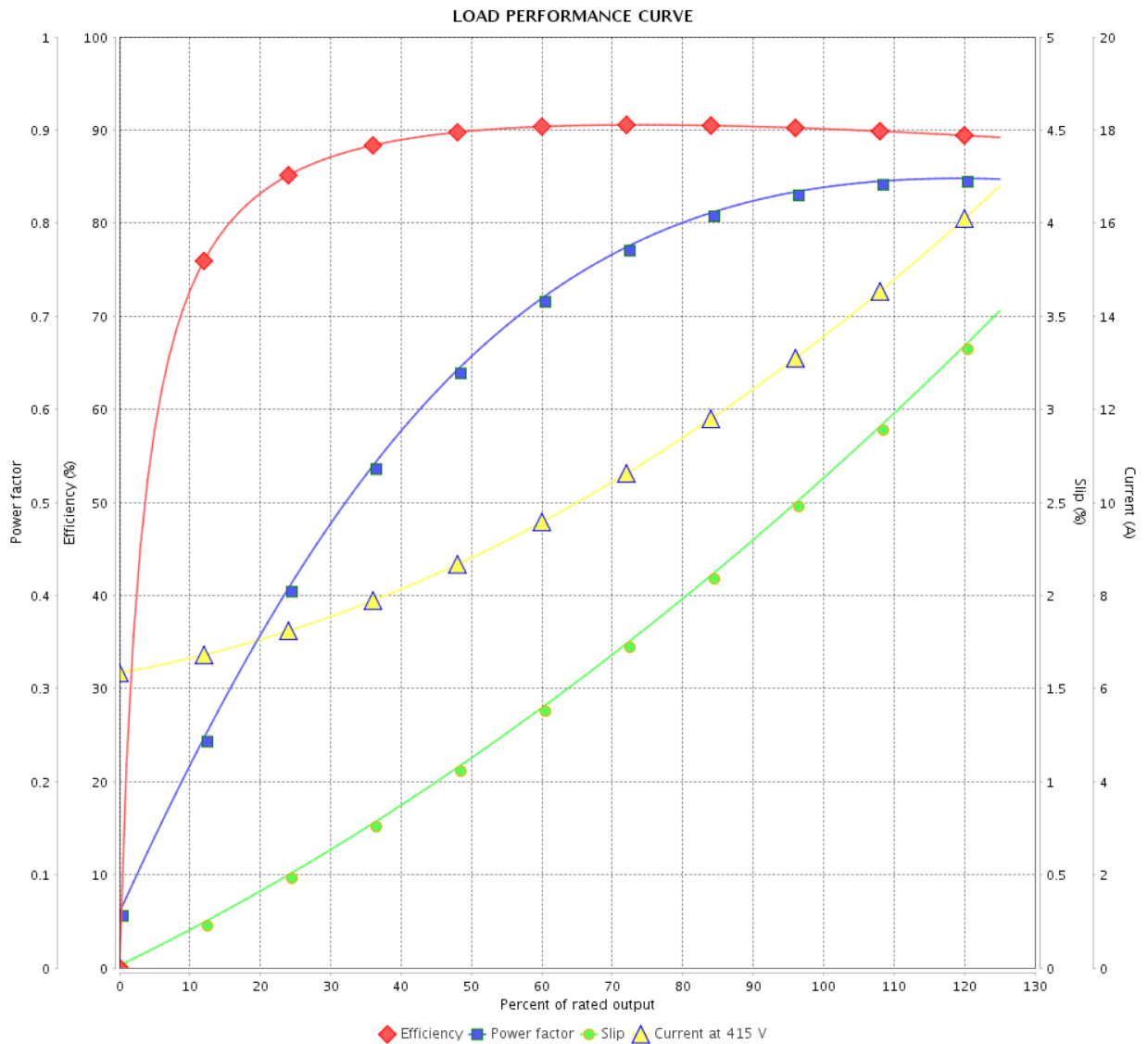

Performance : 415 V 50 Hz 4P IE2

Rated current : 13.8 A  
 LRC : 6.0  
 Rated torque : 36.0 ft.lb  
 Locked rotor torque : 190 %  
 Breakdown torque : 270 %  
 Rated speed : 1460 rpm

Moment of inertia (J) : 1.51 sq.ft.lb  
 Duty cycle : Cont.(S1)  
 Insulation class : F  
 Service factor : 1.15  
 Temperature rise : 80 K  
 Design : B

Rev.	Changes Summary	Performed	Checked	Date
Performed by		Page		Revision
Checked by		15 / 36		
Date		01/06/2022		

# THERMAL LIMIT CURVE



## Three Phase Induction Motor - Squirrel Cage

Customer :

Product line : NEMA Premium Efficiency Three-Phase  
 Product code : 11431991  
 Catalog # : 01018ST3QIE215TC-W22

Performance : 460 V 60 Hz 4P

Rated current : 12.4 A	Moment of inertia (J) : 1.51 sq.ft.lb
LRC : 6.4	Duty cycle : Cont.(S1)
Rated torque : 29.8 ft.lb	Insulation class : F
Locked rotor torque : 200 %	Service factor : 1.25
Breakdown torque : 295 %	Temperature rise : 80 K
Rated speed : 1765 rpm	Design : B

Heating constant

Cooling constant

Rev.	Changes Summary	Performed	Checked	Date
Performed by			Page 16 / 36	Revision
Checked by				
Date	01/06/2022			



# THERMAL LIMIT CURVE

Three Phase Induction Motor - Squirrel Cage



Customer : \_\_\_\_\_

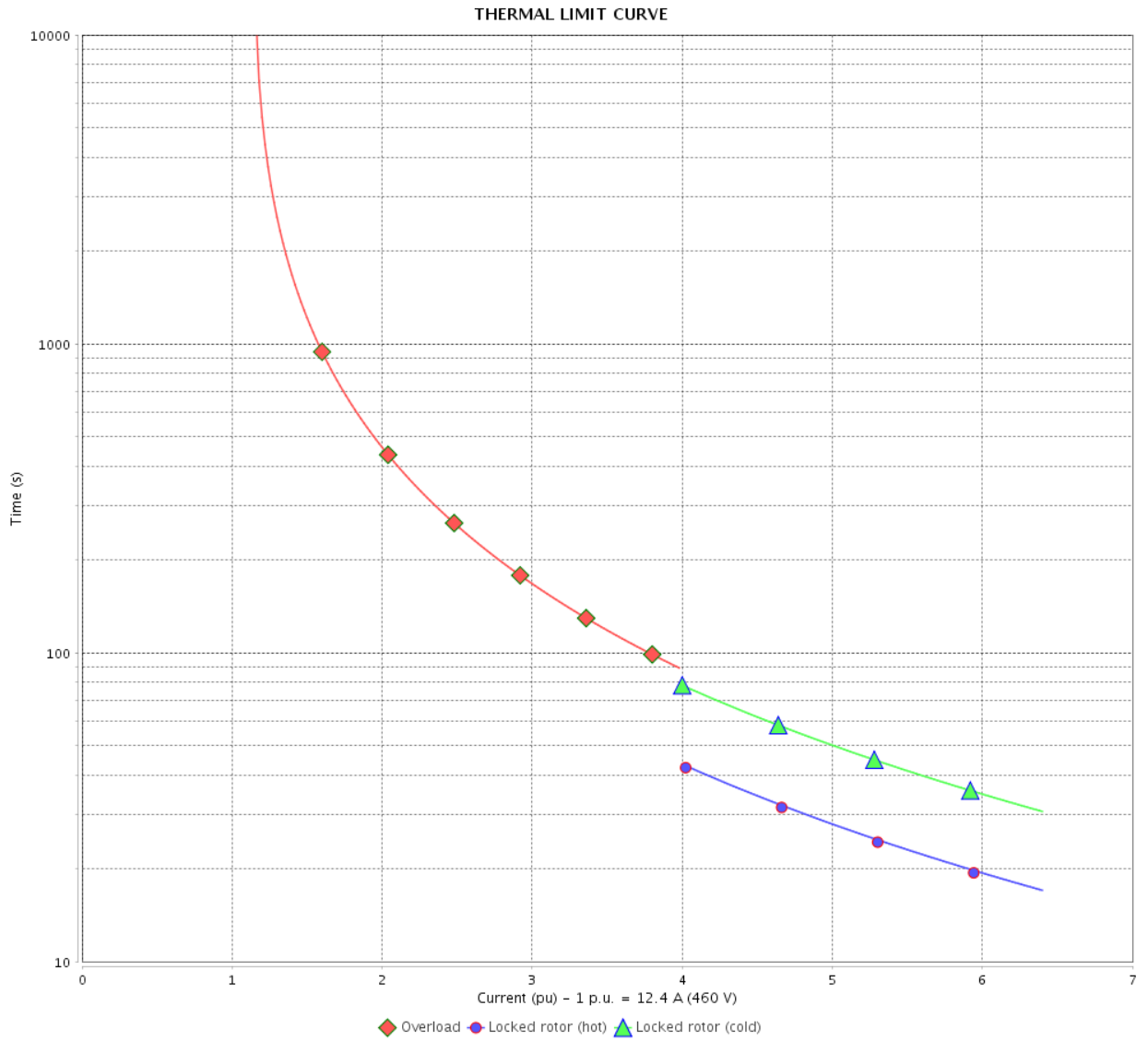

Rev.	Changes Summary	Performed	Checked	Date
Performed by		Page		Revision
Checked by		17 / 36		
Date	01/06/2022			

# THERMAL LIMIT CURVE



## Three Phase Induction Motor - Squirrel Cage

Customer :

Product line : NEMA Premium Efficiency Three-Phase  
Product code : 11431991  
Catalog # : 01018ST3QIE215TC-W22

Performance : 380 V 50 Hz 4P IE3

Rated current	: 11.2 A	Moment of inertia (J)	: 1.51 sq.ft.lb
LRC	: 6.7	Duty cycle	: Cont.(S1)
Rated torque	: 26.9 ft.lb	Insulation class	: F
Locked rotor torque	: 200 %	Service factor	: 1.15
Breakdown torque	: 300 %	Temperature rise	: 80 K
Rated speed	: 1465 rpm	Design	: B

Heating constant

Cooling constant

Rev.	Changes Summary	Performed	Checked	Date
Performed by				
Checked by			Page	Revision
Date	01/06/2022		18 / 36	

# THERMAL LIMIT CURVE

Three Phase Induction Motor - Squirrel Cage



Customer : \_\_\_\_\_

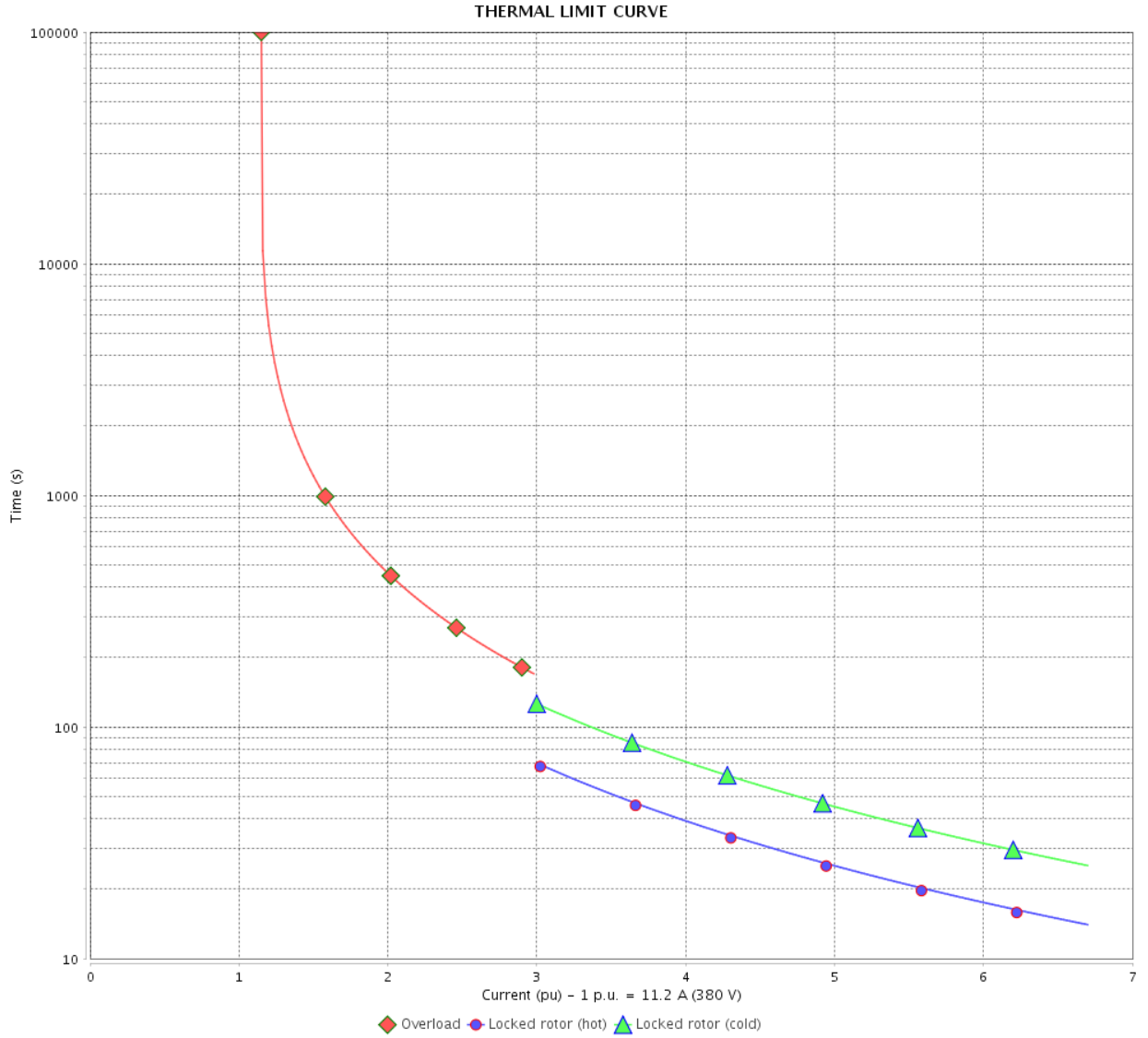

Rev.	Changes Summary	Performed	Checked	Date
Performed by		Page		Revision
Checked by		19 / 36		
Date		01/06/2022		

# THERMAL LIMIT CURVE



## Three Phase Induction Motor - Squirrel Cage

Customer :

Product line : NEMA Premium Efficiency Three-Phase  
 Product code : 11431991  
 Catalog # : 01018ST3QIE215TC-W22

Performance : 400 V 50 Hz 4P IE3

Rated current : 11.0 A	Moment of inertia (J) : 1.51 sq.ft.lb
LRC : 7.1	Duty cycle : Cont.(S1)
Rated torque : 26.8 ft.lb	Insulation class : F
Locked rotor torque : 240 %	Service factor : 1.15
Breakdown torque : 340 %	Temperature rise : 80 K
Rated speed : 1470 rpm	Design : B

Heating constant

Cooling constant

Rev.	Changes Summary	Performed	Checked	Date
Performed by			Page 20 / 36	Revision
Checked by				
Date	01/06/2022			

# THERMAL LIMIT CURVE

Three Phase Induction Motor - Squirrel Cage



Customer : \_\_\_\_\_

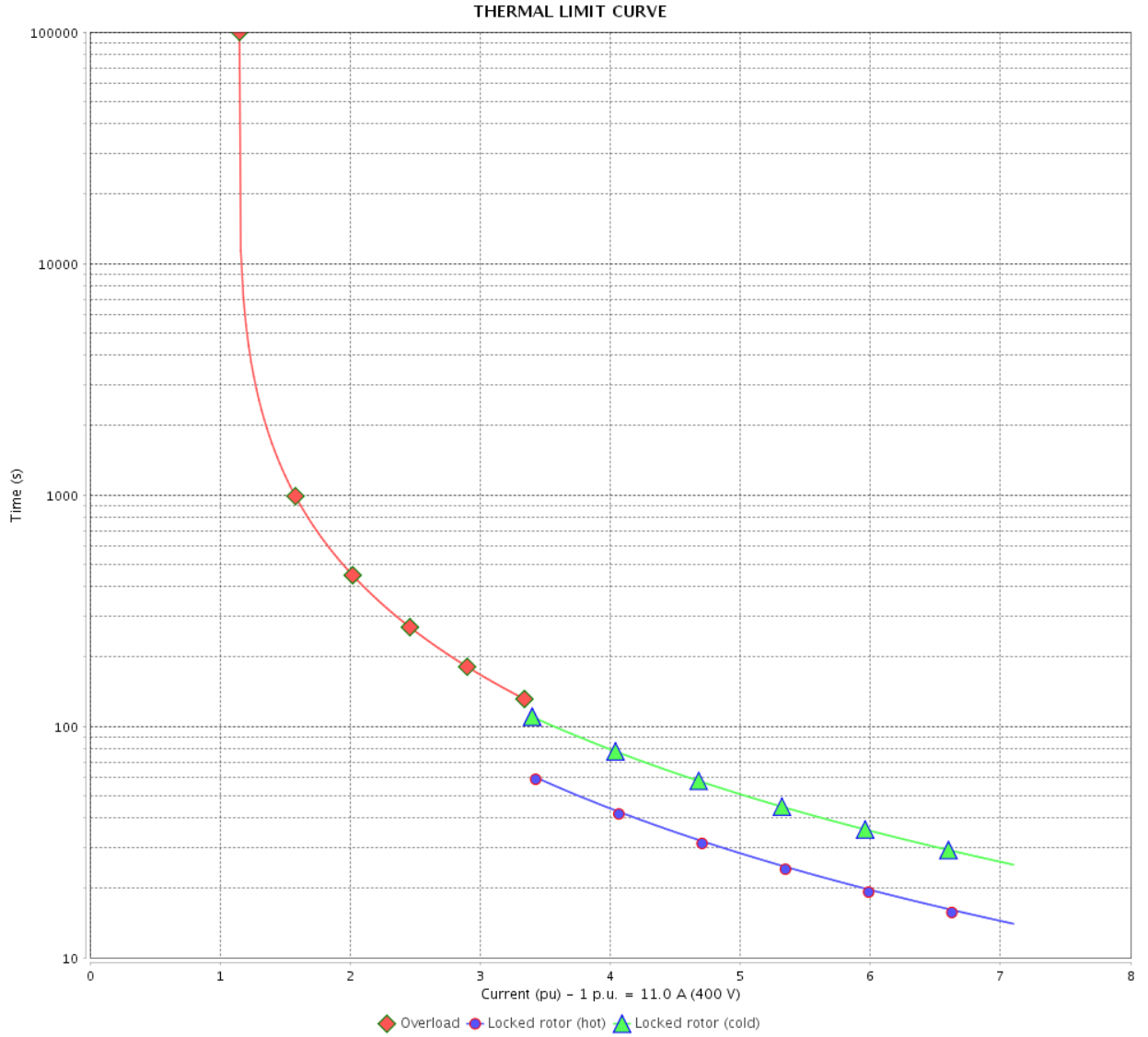

Rev.	Changes Summary	Performed	Checked	Date
Performed by		Page 21 / 36		Revision
Checked by				
Date				

# THERMAL LIMIT CURVE



## Three Phase Induction Motor - Squirrel Cage

Customer :

Product line : NEMA Premium Efficiency Three-Phase  
Product code : 11431991  
Catalog # : 01018ST3QIE215TC-W22

Performance : 415 V 50 Hz 4P IE3

Rated current	: 10.9 A	Moment of inertia (J)	: 1.51 sq.ft.lb
LRC	: 7.5	Duty cycle	: Cont.(S1)
Rated torque	: 26.8 ft.lb	Insulation class	: F
Locked rotor torque	: 260 %	Service factor	: 1.15
Breakdown torque	: 360 %	Temperature rise	: 80 K
Rated speed	: 1470 rpm	Design	: B

Heating constant

Cooling constant

Rev.	Changes Summary	Performed	Checked	Date
Performed by				
Checked by			Page	Revision
Date	01/06/2022		22 / 36	

# THERMAL LIMIT CURVE

Three Phase Induction Motor - Squirrel Cage



Customer : \_\_\_\_\_

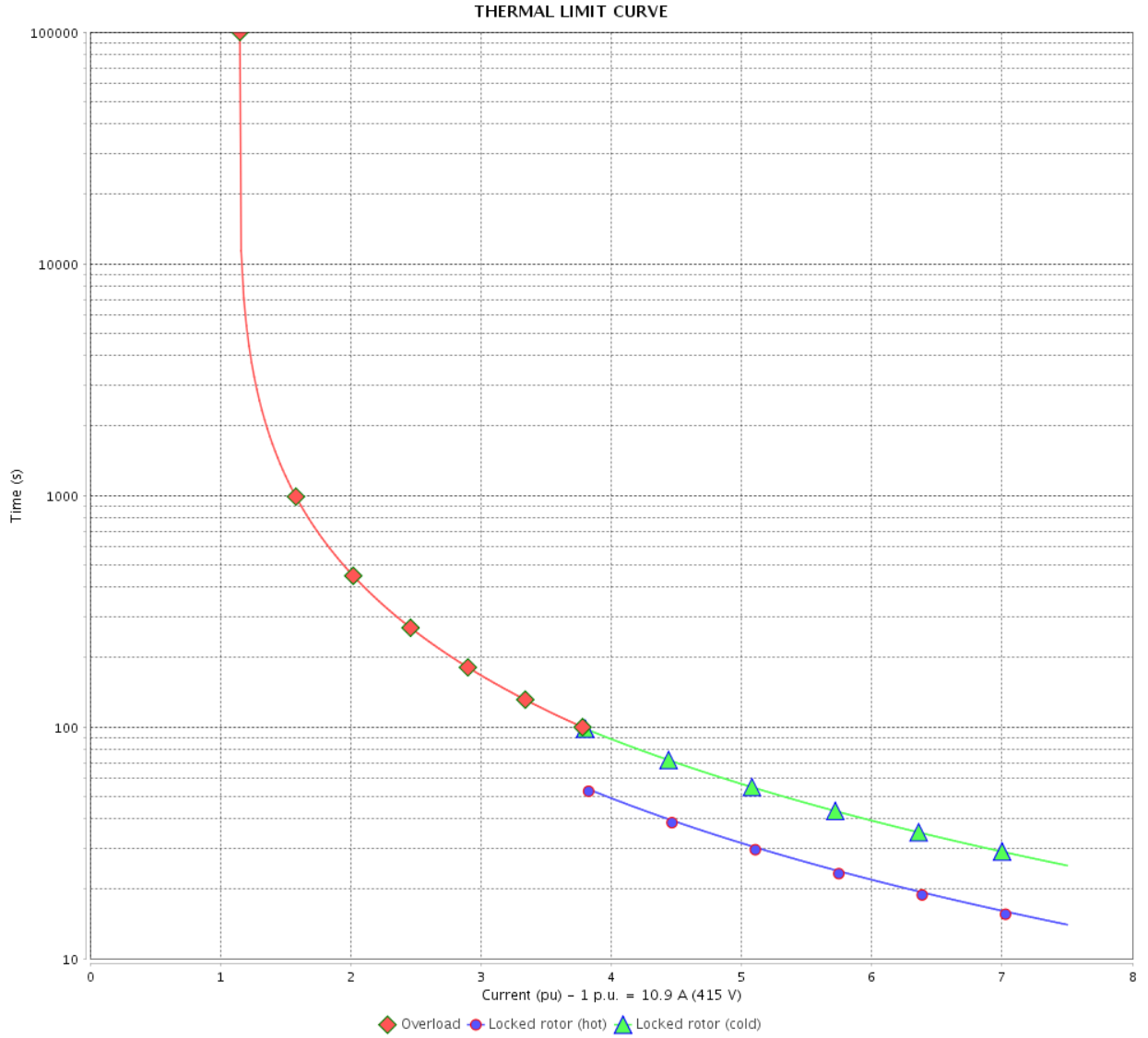

Rev.	Changes Summary	Performed	Checked	Date
Performed by		Page 23 / 36		Revision
Checked by				
Date				

# THERMAL LIMIT CURVE



## Three Phase Induction Motor - Squirrel Cage

Customer :

Product line : NEMA Premium Efficiency Three-Phase  
 Product code : 11431991  
 Catalog # : 01018ST3QIE215TC-W22

Performance : 380 V 50 Hz 4P IE1

Rated current : 15.0 A	Moment of inertia (J) : 1.51 sq.ft.lb
LRC : 5.1	Duty cycle : Cont.(S1)
Rated torque : 36.2 ft.lb	Insulation class : F
Locked rotor torque : 150 %	Service factor : 1.15
Breakdown torque : 220 %	Temperature rise : 80 K
Rated speed : 1450 rpm	Design : B

Heating constant

Cooling constant

Rev.	Changes Summary	Performed	Checked	Date
Performed by			Page	Revision
Checked by				
Date				



# THERMAL LIMIT CURVE

Three Phase Induction Motor - Squirrel Cage



Customer : \_\_\_\_\_

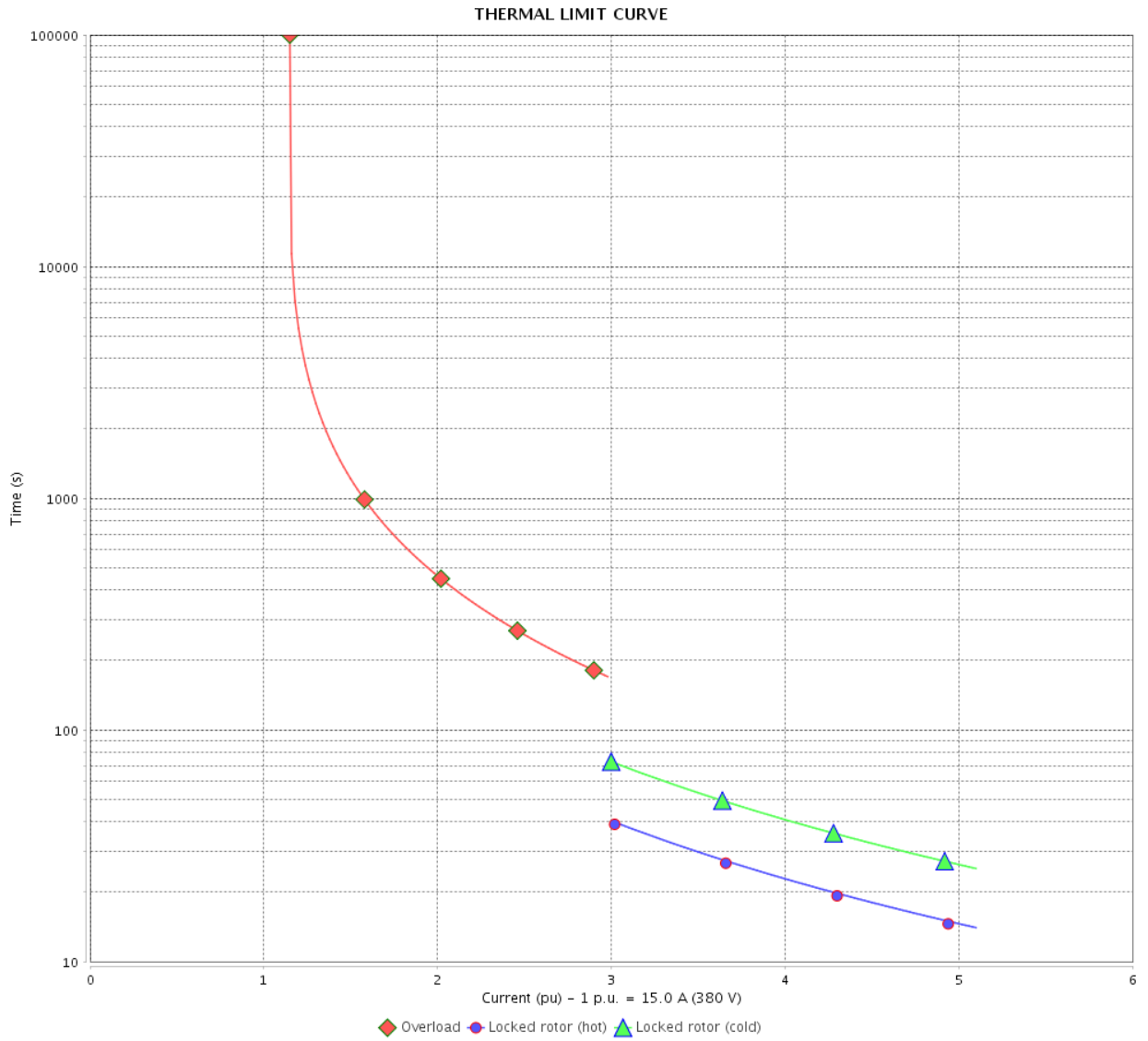

Rev.	Changes Summary	Performed	Checked	Date
Performed by		Page 25 / 36		Revision
Checked by				
Date				

# THERMAL LIMIT CURVE



## Three Phase Induction Motor - Squirrel Cage

Customer :

Product line : NEMA Premium Efficiency Three-Phase  
Product code : 11431991  
Catalog # : 01018ST3QIE215TC-W22

Performance : 400 V 50 Hz 4P IE2

Rated current	: 14.2 A	Moment of inertia (J)	: 1.51 sq.ft.lb
LRC	: 5.6	Duty cycle	: Cont.(S1)
Rated torque	: 36.1 ft.lb	Insulation class	: F
Locked rotor torque	: 180 %	Service factor	: 1.15
Breakdown torque	: 250 %	Temperature rise	: 80 K
Rated speed	: 1455 rpm	Design	: B

Heating constant

Cooling constant

Rev.	Changes Summary	Performed	Checked	Date
Performed by				
Checked by			Page	Revision
Date	01/06/2022		26 / 36	

# THERMAL LIMIT CURVE

Three Phase Induction Motor - Squirrel Cage



Customer : \_\_\_\_\_

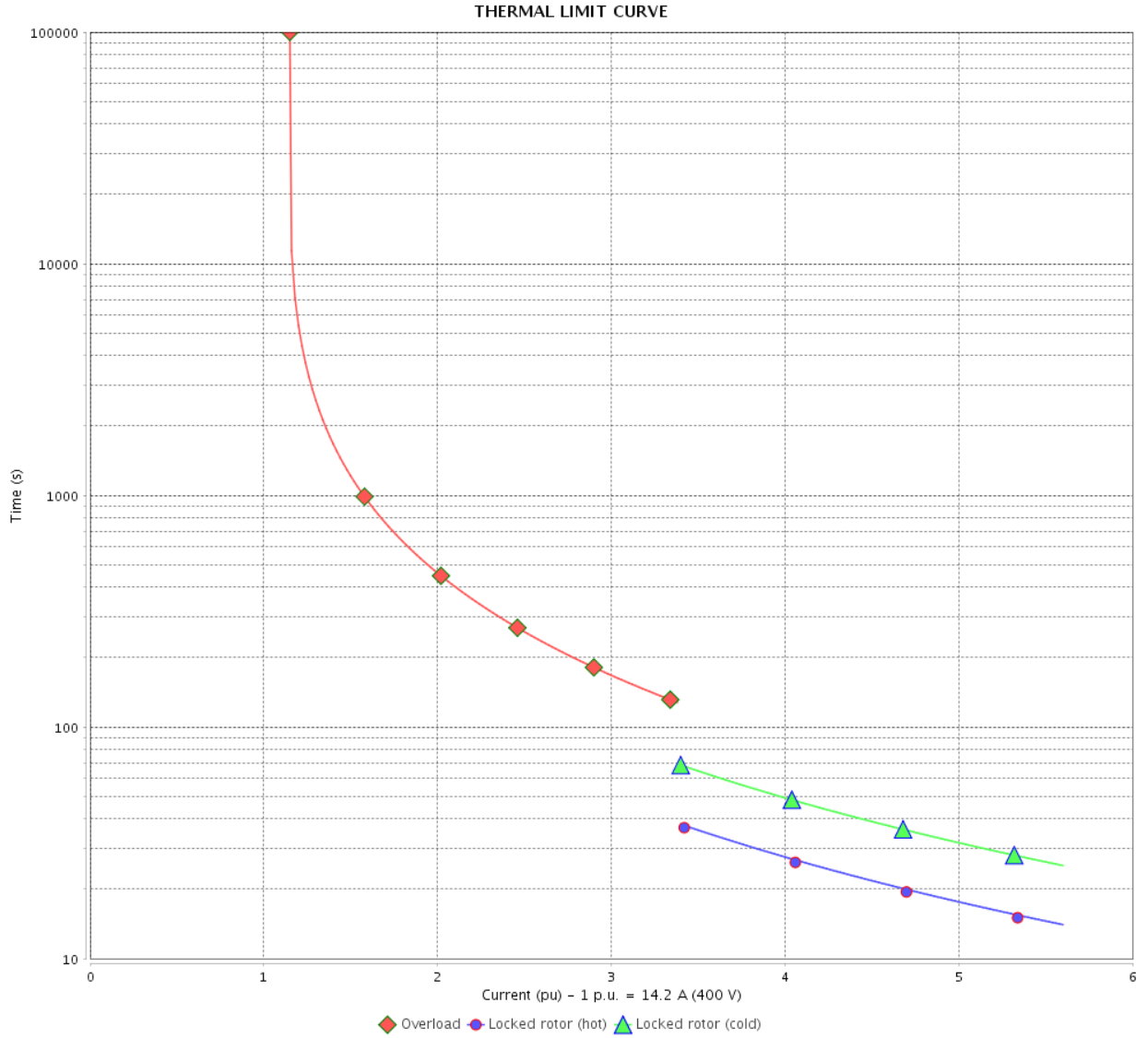

Rev.	Changes Summary	Performed	Checked	Date
Performed by		Page 27 / 36		Revision
Checked by				
Date				

# THERMAL LIMIT CURVE



## Three Phase Induction Motor - Squirrel Cage

Customer :

Product line : NEMA Premium Efficiency Three-Phase

Product code : 11431991

Catalog # : 01018ST3QIE215TC-W22

Performance : 415 V 50 Hz 4P IE2

Rated current	: 13.8 A	Moment of inertia (J)	: 1.51 sq.ft.lb
LRC	: 6.0	Duty cycle	: Cont.(S1)
Rated torque	: 36.0 ft.lb	Insulation class	: F
Locked rotor torque	: 190 %	Service factor	: 1.15
Breakdown torque	: 270 %	Temperature rise	: 80 K
Rated speed	: 1460 rpm	Design	: B

Heating constant

Cooling constant

Rev.	Changes Summary	Performed	Checked	Date
Performed by				
Checked by			Page	Revision
Date	01/06/2022		28 / 36	

# THERMAL LIMIT CURVE

Three Phase Induction Motor - Squirrel Cage



Customer : \_\_\_\_\_

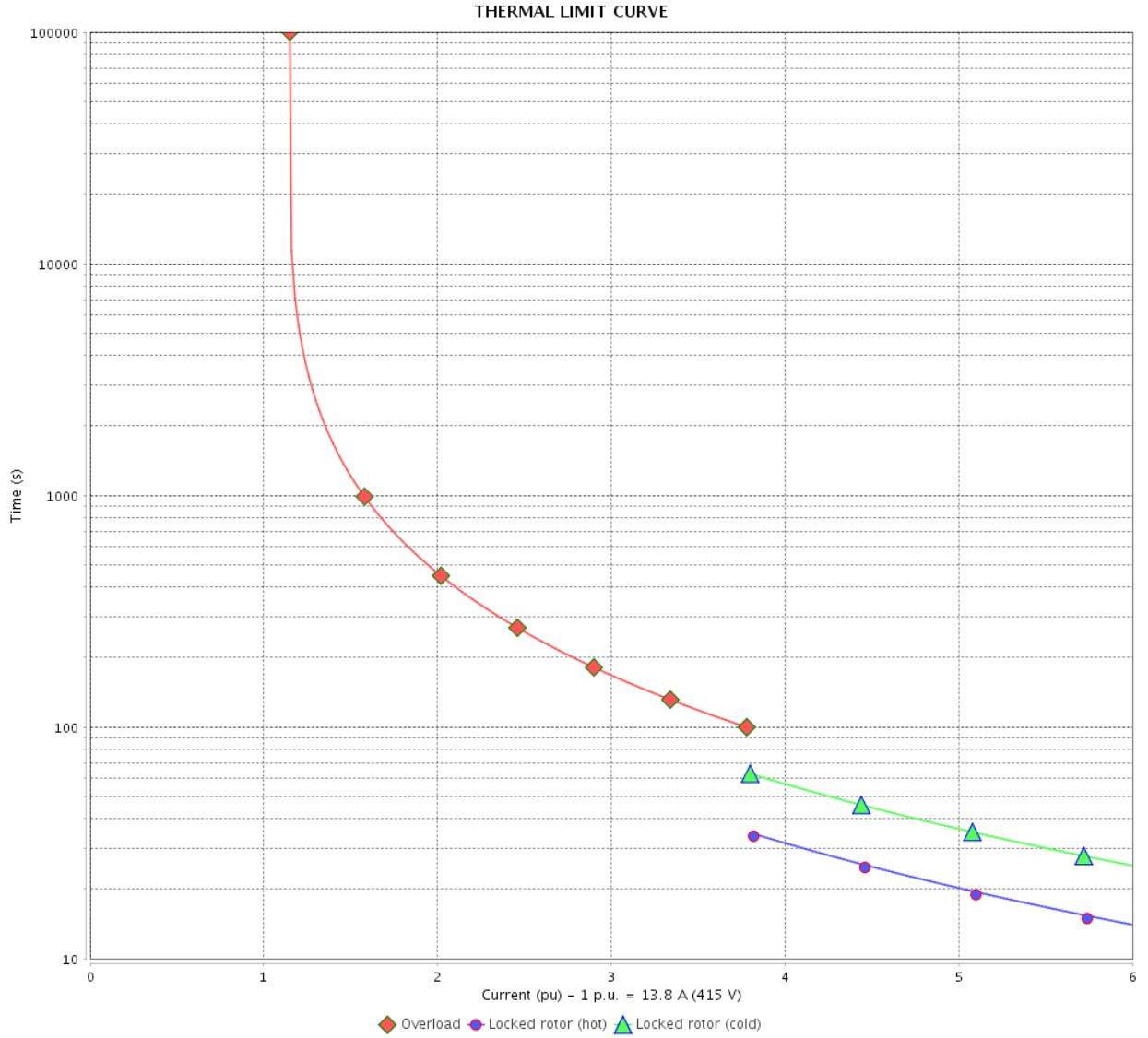

Rev.	Changes Summary	Performed	Checked	Date
Performed by		Page 29 / 36		Revision
Checked by				
Date				

# VFD OPERATION CURVE

Three Phase Induction Motor - Squirrel Cage



Customer :

Product line : NEMA Premium Efficiency Three-Phase

Product code : 11431991

Catalog # : 01018ST3QIE215TC-W22

VFD OPERATION CURVE

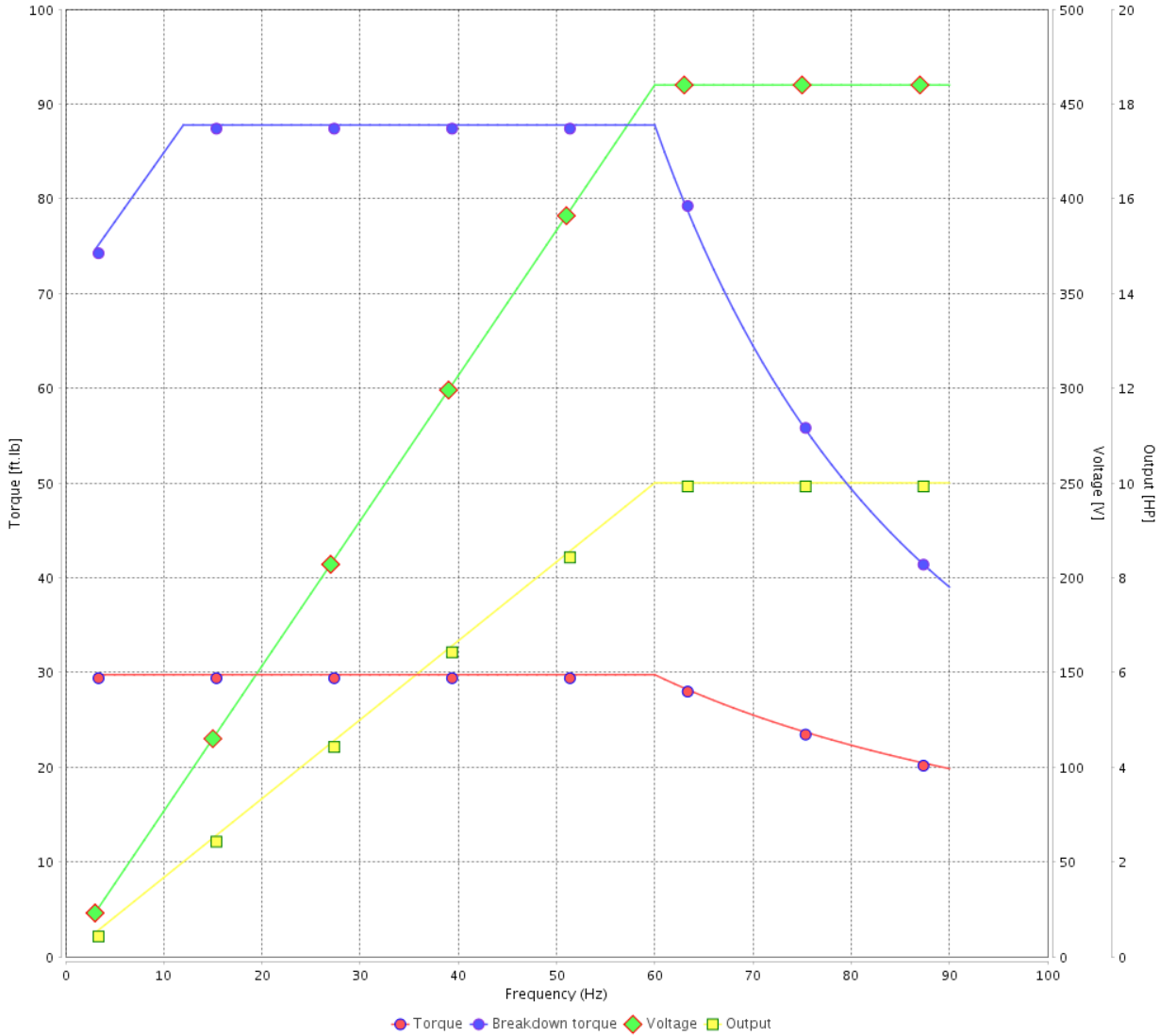

Performance : 460 V 60 Hz 4P

Rated current : 12.4 A  
 LRC : 6.4  
 Rated torque : 29.8 ft.lb  
 Locked rotor torque : 200 %  
 Breakdown torque : 295 %  
 Rated speed : 1765 rpm

Moment of inertia (J) : 1.51 sq.ft.lb  
 Duty cycle : Cont.(S1)  
 Insulation class : F  
 Service factor : 1.25  
 Temperature rise : 80 K  
 Design : B

Rev.	Changes Summary	Performed	Checked	Date
Performed by			Page	Revision
Checked by				
Date				

# VFD OPERATION CURVE

## Three Phase Induction Motor - Squirrel Cage



Customer :

Product line : NEMA Premium Efficiency Three-Phase

Product code : 11431991

Catalog # : 01018ST3QIE215TC-W22

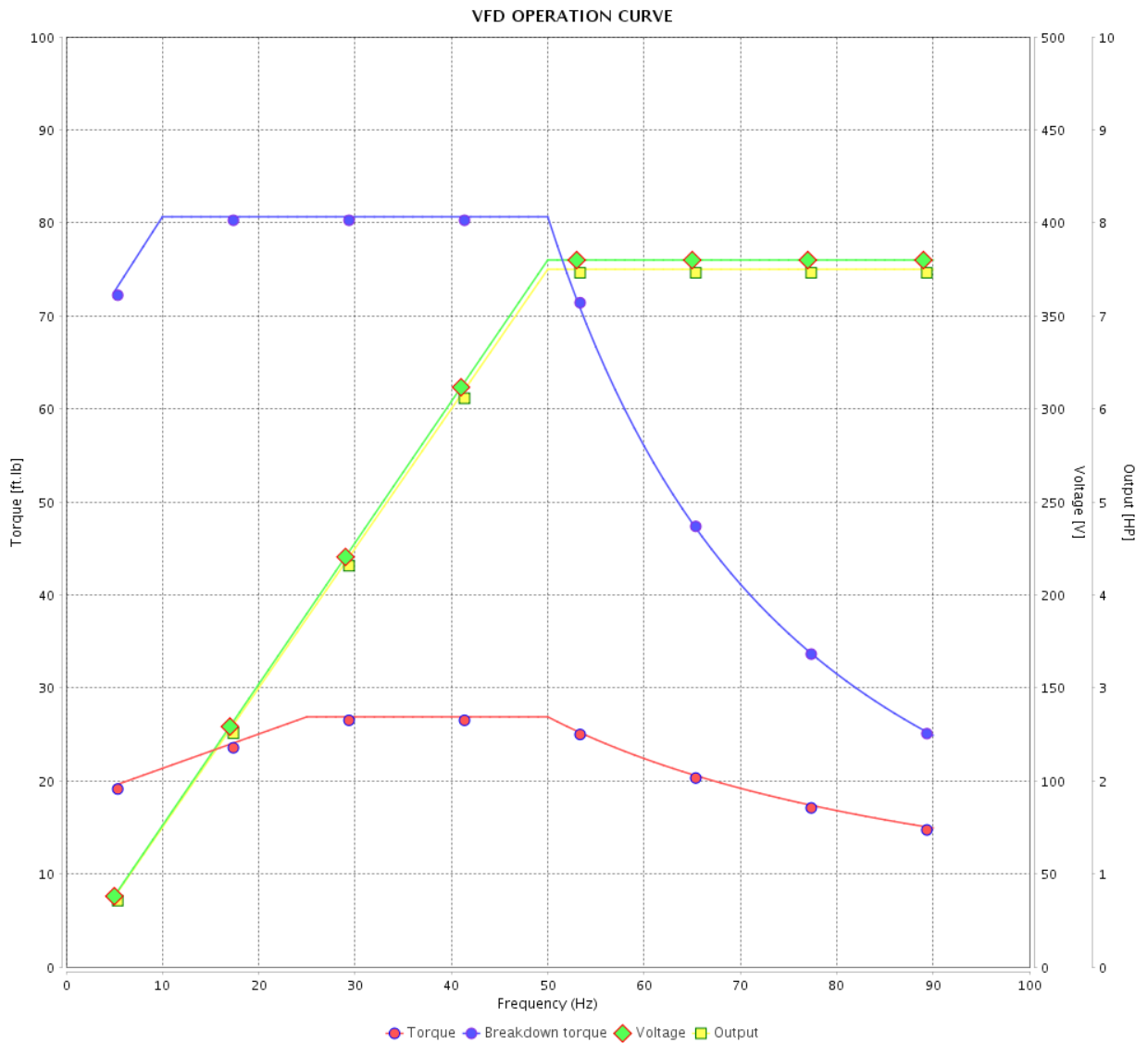

Performance : 380 V 50 Hz 4P IE3

Rated current : 11.2 A  
 LRC : 6.7  
 Rated torque : 26.9 ft.lb  
 Locked rotor torque : 200 %  
 Breakdown torque : 300 %  
 Rated speed : 1465 rpm

Moment of inertia (J) : 1.51 sq.ft.lb  
 Duty cycle : Cont.(S1)  
 Insulation class : F  
 Service factor : 1.15  
 Temperature rise : 80 K  
 Design : B

Rev.	Changes Summary	Performed	Checked	Date
Performed by			Page 31 / 36	Revision
Checked by				
Date	01/06/2022			

# VFD OPERATION CURVE

Three Phase Induction Motor - Squirrel Cage



Customer : \_\_\_\_\_

Product line : NEMA Premium Efficiency Three-Phase

Product code : 11431991

Catalog # : 01018ST3QIE215TC-W22

VFD OPERATION CURVE

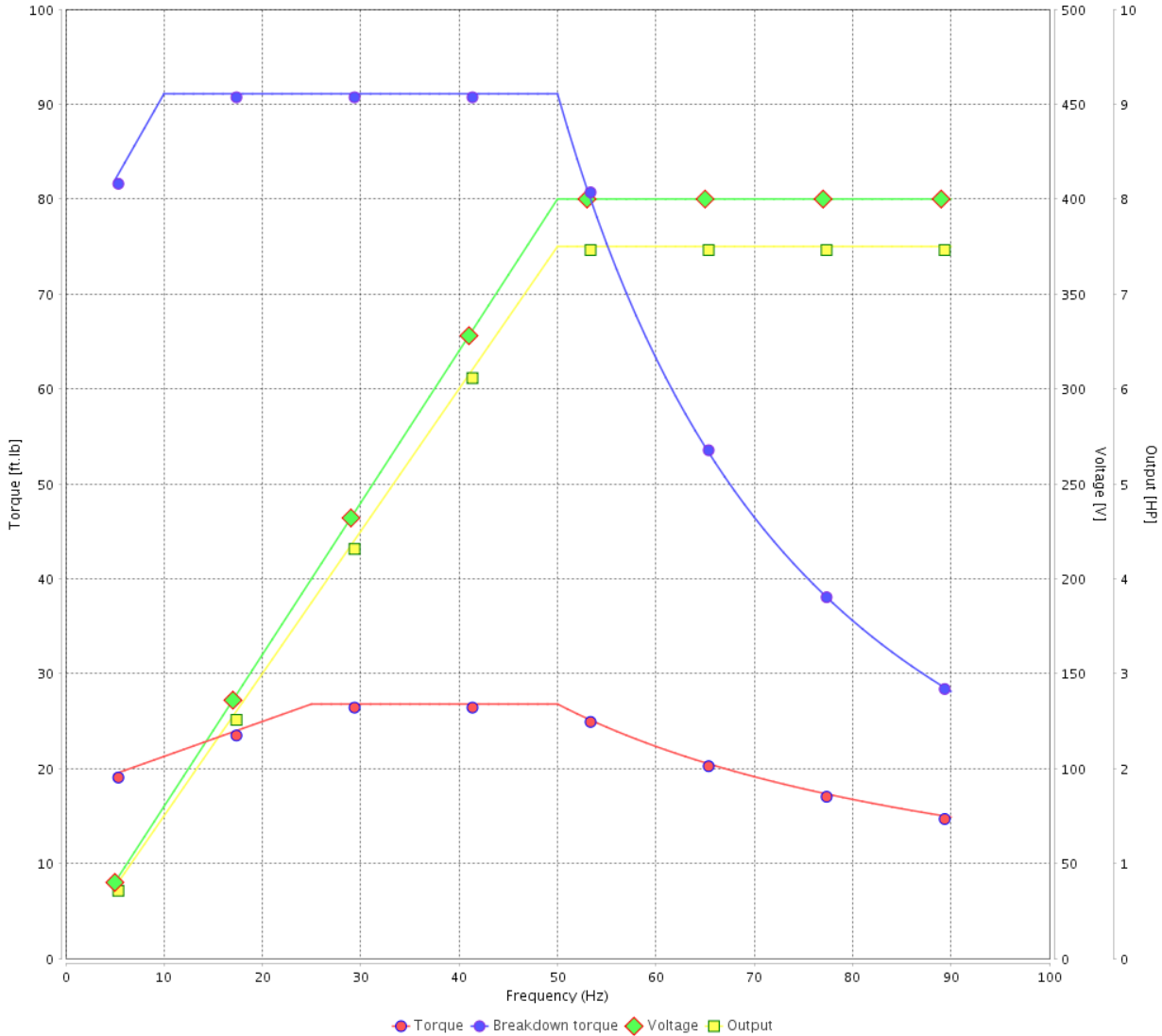

Performance : 400 V 50 Hz 4P IE3

Rated current : 11.0 A  
 LRC : 7.1  
 Rated torque : 26.8 ft.lb  
 Locked rotor torque : 240 %  
 Breakdown torque : 340 %  
 Rated speed : 1470 rpm

Moment of inertia (J) : 1.51 sq.ft.lb  
 Duty cycle : Cont.(S1)  
 Insulation class : F  
 Service factor : 1.15  
 Temperature rise : 80 K  
 Design : B

Rev.	Changes Summary	Performed	Checked	Date
Performed by			Page 32 / 36	Revision
Checked by				
Date	01/06/2022			



# VFD OPERATION CURVE

## Three Phase Induction Motor - Squirrel Cage



Customer : \_\_\_\_\_

Product line : NEMA Premium Efficiency Three-Phase

Product code : 11431991

Catalog # : 01018ST3QIE215TC-W22

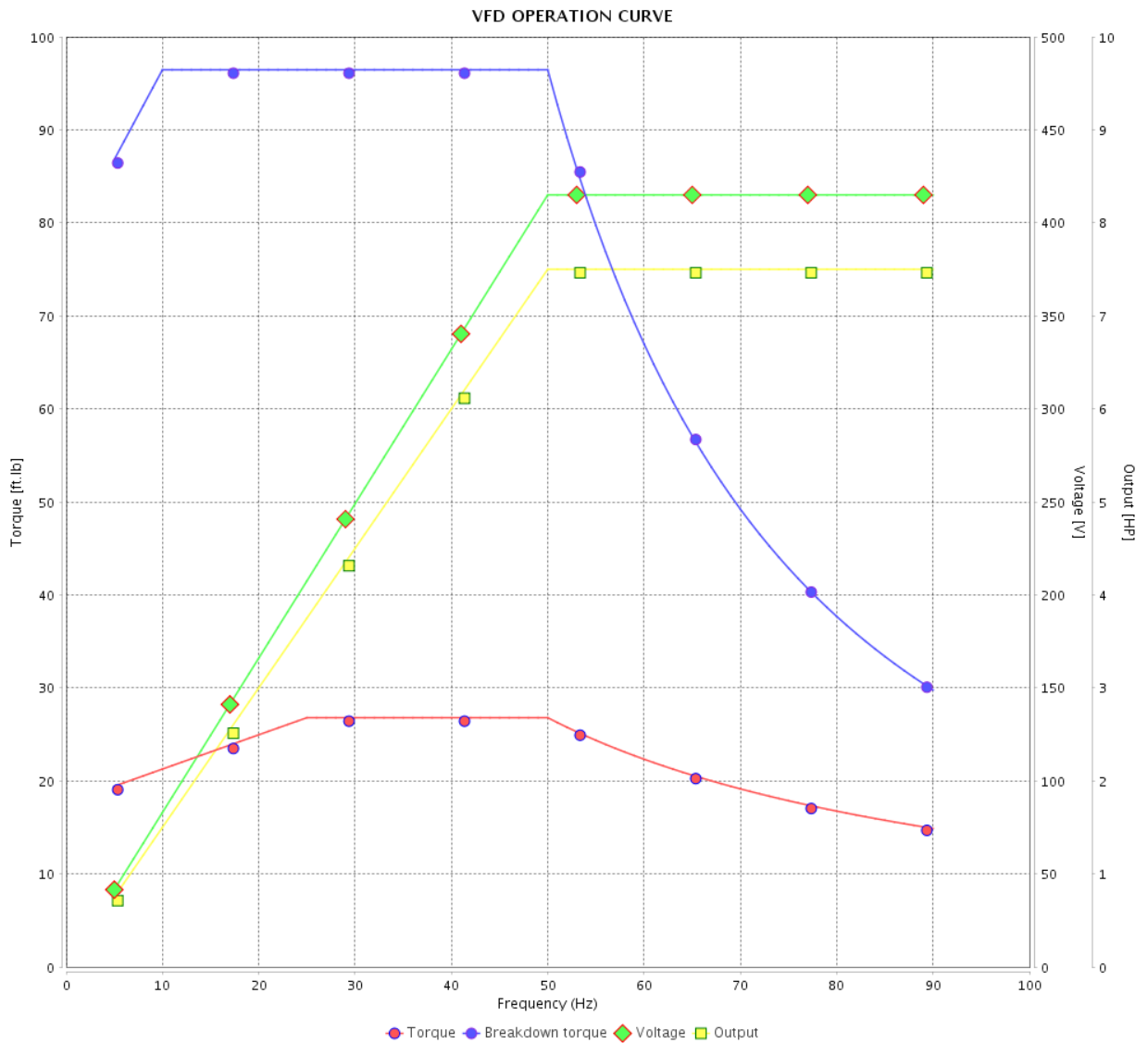

Performance : 415 V 50 Hz 4P IE3

Rated current : 10.9 A  
 LRC : 7.5  
 Rated torque : 26.8 ft.lb  
 Locked rotor torque : 260 %  
 Breakdown torque : 360 %  
 Rated speed : 1470 rpm

Moment of inertia (J) : 1.51 sq.ft.lb  
 Duty cycle : Cont.(S1)  
 Insulation class : F  
 Service factor : 1.15  
 Temperature rise : 80 K  
 Design : B

Rev.	Changes Summary	Performed	Checked	Date
Performed by			Page 33 / 36	Revision
Checked by				
Date	01/06/2022			

# VFD OPERATION CURVE

Three Phase Induction Motor - Squirrel Cage



Customer :

Product line : NEMA Premium Efficiency Three-Phase

Product code : 11431991

Catalog # : 01018ST3QIE215TC-W22

VFD OPERATION CURVE

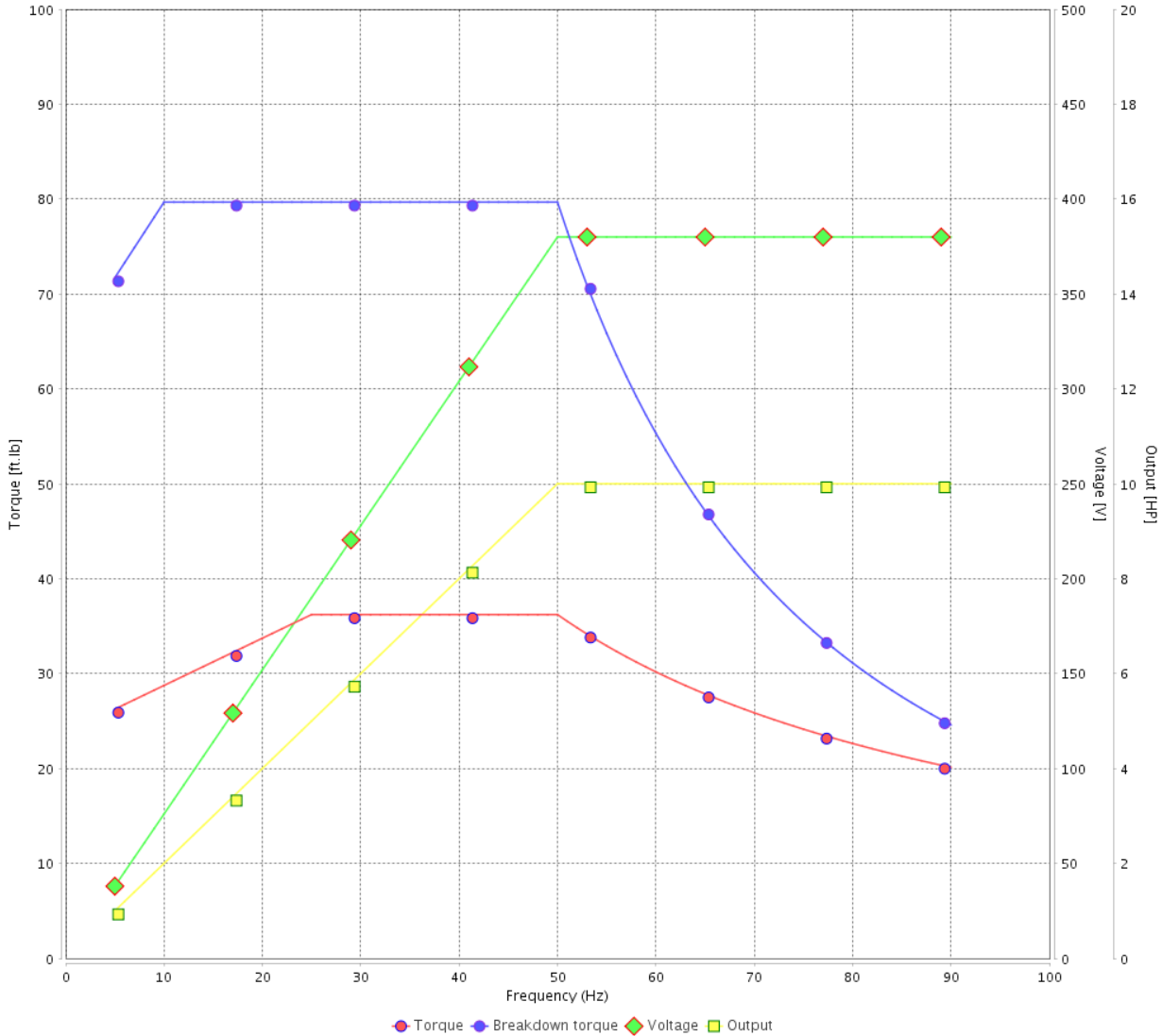

Performance : 380 V 50 Hz 4P IE1

Rated current : 15.0 A  
 LRC : 5.1  
 Rated torque : 36.2 ft.lb  
 Locked rotor torque : 150 %  
 Breakdown torque : 220 %  
 Rated speed : 1450 rpm

Moment of inertia (J) : 1.51 sq.ft.lb  
 Duty cycle : Cont.(S1)  
 Insulation class : F  
 Service factor : 1.15  
 Temperature rise : 80 K  
 Design : B

Rev.	Changes Summary	Performed	Checked	Date
Performed by			Page 34 / 36	Revision
Checked by				
Date	01/06/2022			

# VFD OPERATION CURVE

## Three Phase Induction Motor - Squirrel Cage



Customer : \_\_\_\_\_

Product line : NEMA Premium Efficiency Three-Phase

Product code : 11431991

Catalog # : 01018ST3QIE215TC-W22

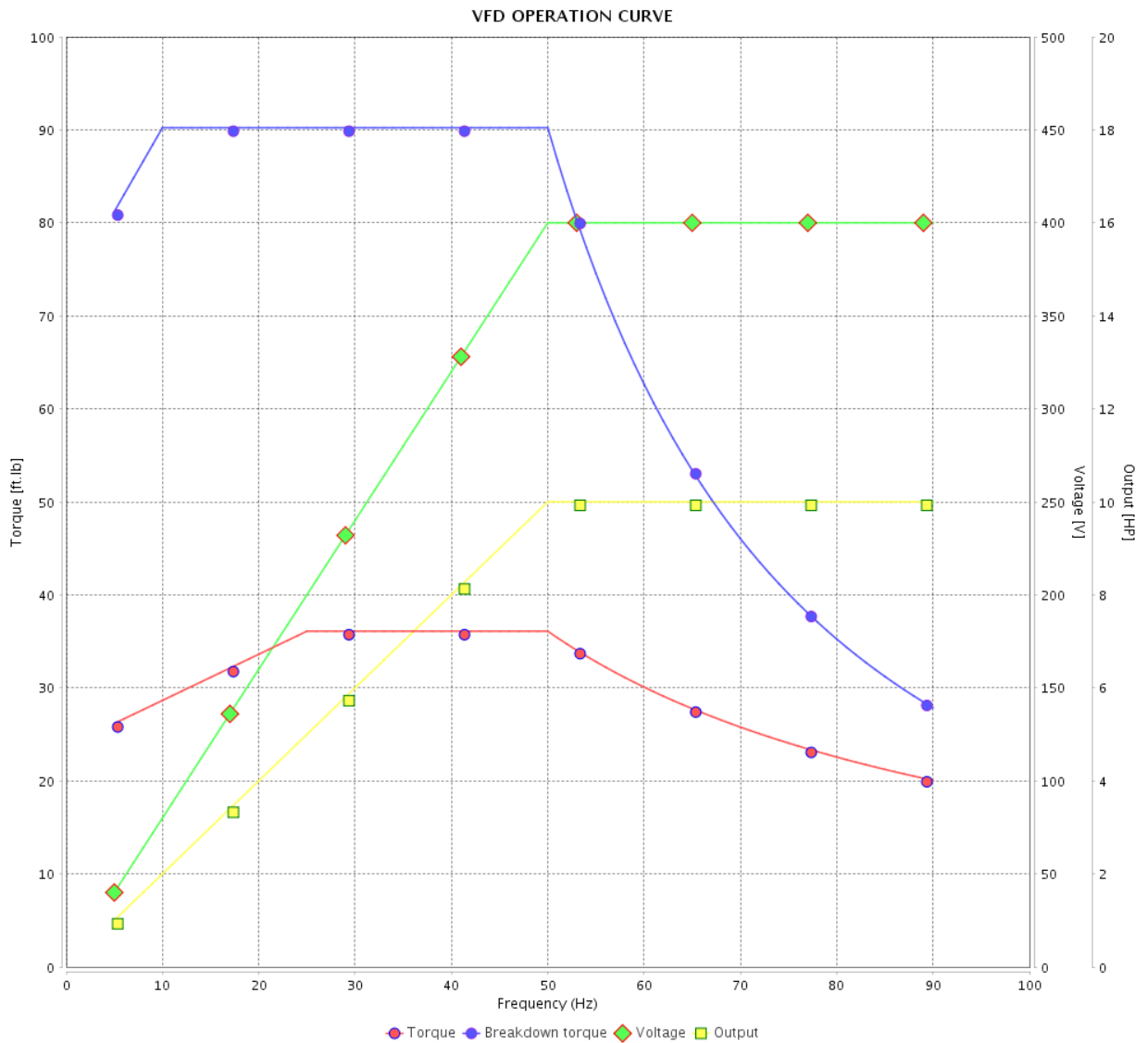

Performance : 400 V 50 Hz 4P IE2

Rated current : 14.2 A  
 LRC : 5.6  
 Rated torque : 36.1 ft.lb  
 Locked rotor torque : 180 %  
 Breakdown torque : 250 %  
 Rated speed : 1455 rpm

Moment of inertia (J) : 1.51 sq.ft.lb  
 Duty cycle : Cont.(S1)  
 Insulation class : F  
 Service factor : 1.15  
 Temperature rise : 80 K  
 Design : B

Rev.	Changes Summary	Performed	Checked	Date
Performed by		Page		Revision
Checked by		35 / 36		
Date	01/06/2022			

# VFD OPERATION CURVE

Three Phase Induction Motor - Squirrel Cage



Customer :

Product line : NEMA Premium Efficiency Three-Phase

Product code : 11431991

Catalog # : 01018ST3QIE215TC-W22

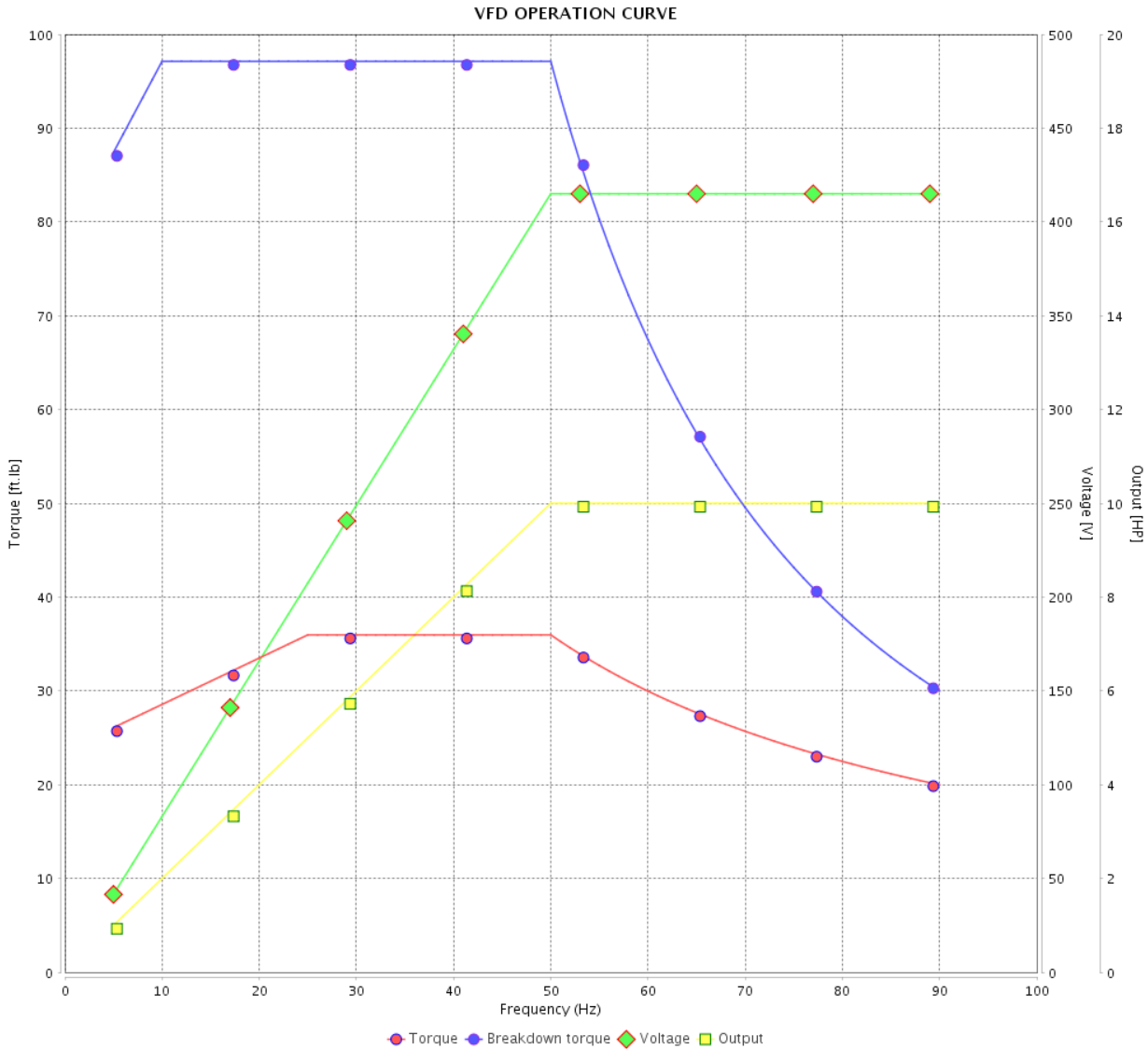

Performance : 415 V 50 Hz 4P IE2

Rated current : 13.8 A  
 LRC : 6.0  
 Rated torque : 36.0 ft.lb  
 Locked rotor torque : 190 %  
 Breakdown torque : 270 %  
 Rated speed : 1460 rpm

Moment of inertia (J) : 1.51 sq.ft.lb  
 Duty cycle : Cont.(S1)  
 Insulation class : F  
 Service factor : 1.15  
 Temperature rise : 80 K  
 Design : B

Rev.	Changes Summary	Performed	Checked	Date
Performed by			Page 36 / 36	Revision
Checked by				
Date	01/06/2022			

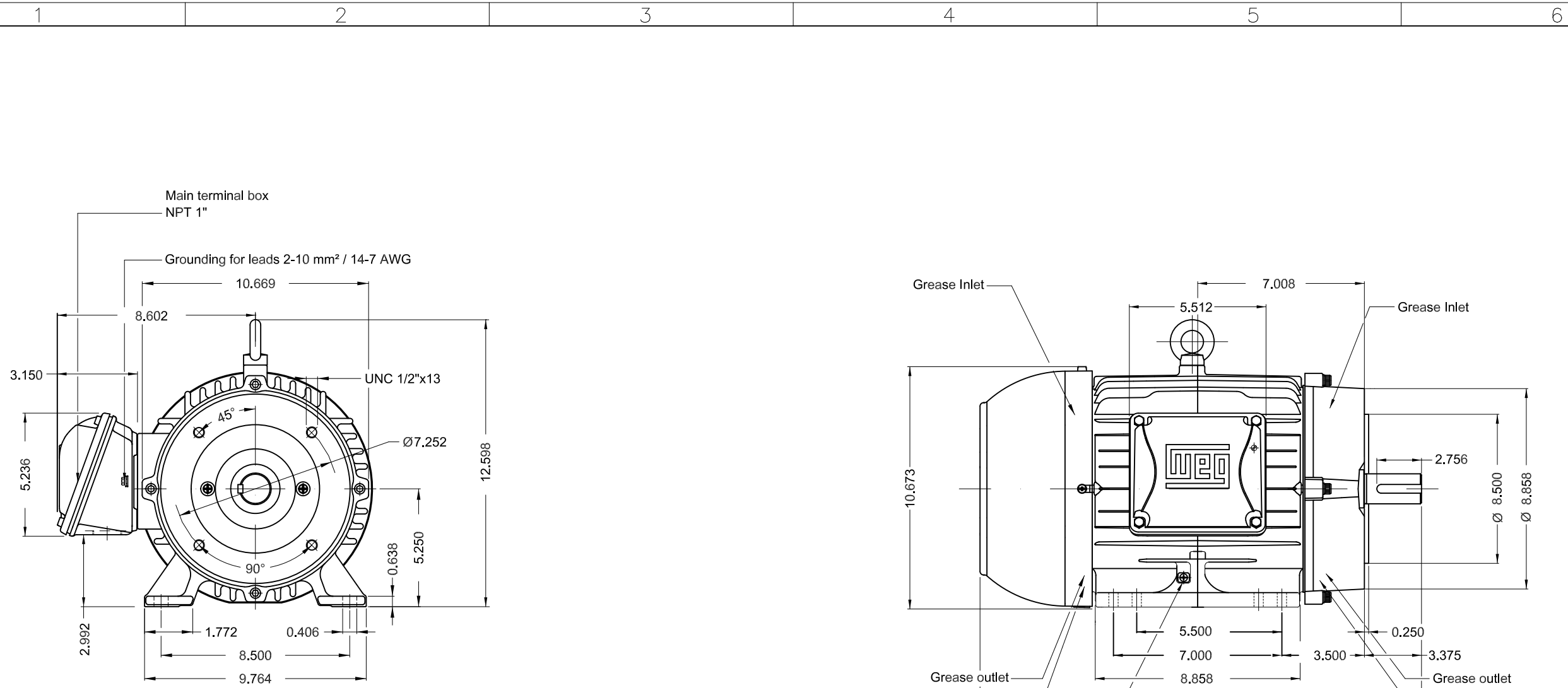

Grounding for leads 2-10 mm<sup>2</sup> / 14-7 AWG

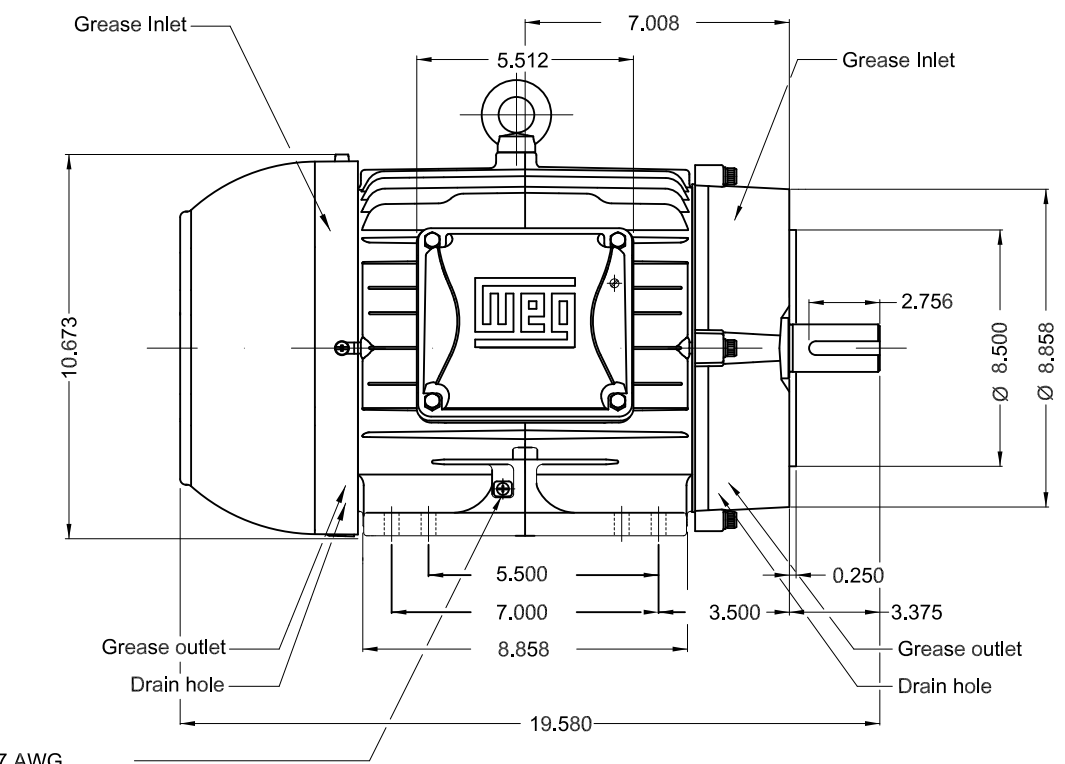

10 HP 04 Poles 60 Hz A

Color RAL 5009  
 Painting plan 202E  
 Mounting B34R(D)

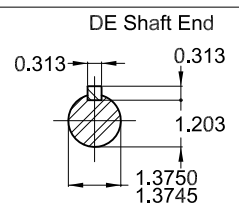

ECM	LOC	SUMMARY OF MODIFICATIONS	EXECUTED	CHECKED	RELEASED	DATE	VER
EXECUTED	HYBRISUSER	THREE PH. MOTOR IEEE 841 W22 PREM. EFF.					
CHECKED		FRAME 213/5TC IP55 TEFC					
RELEASED							
REL DT.	WMO	Jaragua do Sul	Product Engineering				

**PREVIEW**  
 WDD  
 SHEET 1 / 1



MADE IN BRAZIL  
11431991



**NEMA**  
Premium

**W22**

IE010404W22CIS

Inverter Duty Motor  
Severe Duty

**IEEE**  
841-2009



Class I, Div 2, Gr A, B, C and D - T3  
Class I, Zone 2, IIC - T3  
Class II, Div 2, Gr F and G - T4  
For use on PWM: Gr. A, B, C, D and F,  
VT 1000:1, CT 20:1, 1.00SF - T3A



FOR SAFE AREA  
Mod. TE1BFOXON  
CC029A

PH3 60Hz Fr. 213/5TC 1000m.a.s.l. IP55 TEFC 191lb

V 460

A 12.4

HP 10

kW 7.5

SF 1.25

SFA 15.5

RPM 1765

PF 0.83

AMB 40°C

INS cl. F DT80K

NEMA NOM EFF 91.7%

DUTY CONT.

DES B Code H

GUARANT. EFF 90.2%

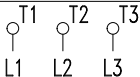

460V



→ 6308-C3 (11g) 40BC03X30

→ 6207-C3 (7g) 35BC02X30

MOBIL POLYREX EM (20000h)

