

DATA SHEET



Three Phase Induction Motor - Squirrel Cage

Customer :							
Product line	: NEMA Premium Efficiency Three-Phase						
Product code :	11441768						
Catalog # :	01036ET3E215T-W22						
Frame	: 213/5T						
Insulation class	: F						
Duty cycle	: Cont.(S1)						
Ambient temperature	: -20°C to +40°C						
Altitude	: 1000 m.a.s.l.						
Protection degree	: IP55						
Design	: B						
Cooling method	: IC411 - TEFC						
Mounting	: F-1						
Rotation ¹	: Both (CW and CCW)						
Starting method	: Direct On Line						
Approx. weight ²	: 176 lb						
Moment of inertia (J)	: 0.6362 sq.ft.lb						
Output [HP]	10	7.5	7.5	7.5	10	10	10
Poles	2	2	2	2	2	2	2
Frequency [Hz]	60	50	50	50	50	50	50
Rated voltage [V]	230/460	380	400	415	380	400	415
Rated current [A]	23.2/11.6	10.4	10.1	9.91	14.1	13.4	13.1
L. R. Amperes [A]	167/83.5	77.0	84.8	90.2	79.0	85.8	90.4
LRC [A]	7.2x(Code H)	7.4x(Code H)	8.4x(Code J)	9.1x(Code K)	5.6x(Code F)	6.4x(Code G)	6.9x(Code H)
No load current [A]	6.80/3.40	3.40	3.70	3.90	3.40	3.70	3.90
Rated speed [RPM]	3510	2925	2935	2940	2870	2890	2900
Slip [%]	2.50	2.50	2.17	2.00	4.33	3.67	3.33
Rated torque [ft.lb]	15.0	13.5	13.4	13.4	18.3	18.2	18.1
Locked rotor torque [%]	220	240	270	290	170	200	220
Breakdown torque [%]	290	300	340	360	220	250	270
Service factor	1.25	1.25	1.25	1.25	1.00	1.00	1.00
Temperature rise	80 K	80 K	80 K	80 K	105 K	105 K	105 K
Locked rotor time	43s (cold) 24s (hot)	32s (cold) 18s (hot)	32s (cold) 18s (hot)	50s (cold) 28s (hot)	32s (cold) 18s (hot)	32s (cold) 18s (hot)	32s (cold) 18s (hot)
Noise level ²	68.0 dB(A)	63.0 dB(A)	63.0 dB(A)	63.0 dB(A)	63.0 dB(A)	63.0 dB(A)	63.0 dB(A)
Efficiency (%)	25%						
	50%	89.5	88.6	88.4	87.7	89.5	89.5
	75%	90.2	89.6	89.6	89.5	89.5	89.5
	100%	90.2	89.5	89.5	89.8	88.5	88.5
Power Factor	25%						
	50%	0.79	0.75	0.72	0.70	0.83	0.81
	75%	0.87	0.86	0.83	0.82	0.90	0.88
	100%	0.90	0.90	0.88	0.86	0.91	0.91
Bearing type	: Drive end : 6308 ZZ	Non drive end : 6207 ZZ	Foundation loads				
Sealing	: V'Ring	V'Ring	Max. traction : 188 lb				
Lubrication interval	: -	-	Max. compression : 364 lb				
Lubricant amount	: -	-					
Lubricant type	: Mobil Polyrex EM						
Notes USABLE @208V 25.7A SF 1.15 SFA 29.5A							
This revision replaces and cancel the previous one, which must be eliminated. (1) Looking the motor from the shaft end. (2) Measured at 1m and with tolerance of +3dB(A). (3) Approximate weight subject to changes after manufacturing process. (4) At 100% of full load.				These are average values based on tests with sinusoidal power supply, subject to the tolerances stipulated in NEMA MG-1.			
Rev.	Changes Summary			Performed	Checked	Date	
Performed by							
Checked by						Page	Revision
Date	12/04/2022					1 / 36	

TORQUE AND CURRENT VS SPEED CURVE

Three Phase Induction Motor - Squirrel Cage



Customer :

Product line : NEMA Premium Efficiency Three-Phase

Product code : 11441768

Catalog # : 01036ET3E215T-W22

TORQUE AND CURRENT VS SPEED CURVE

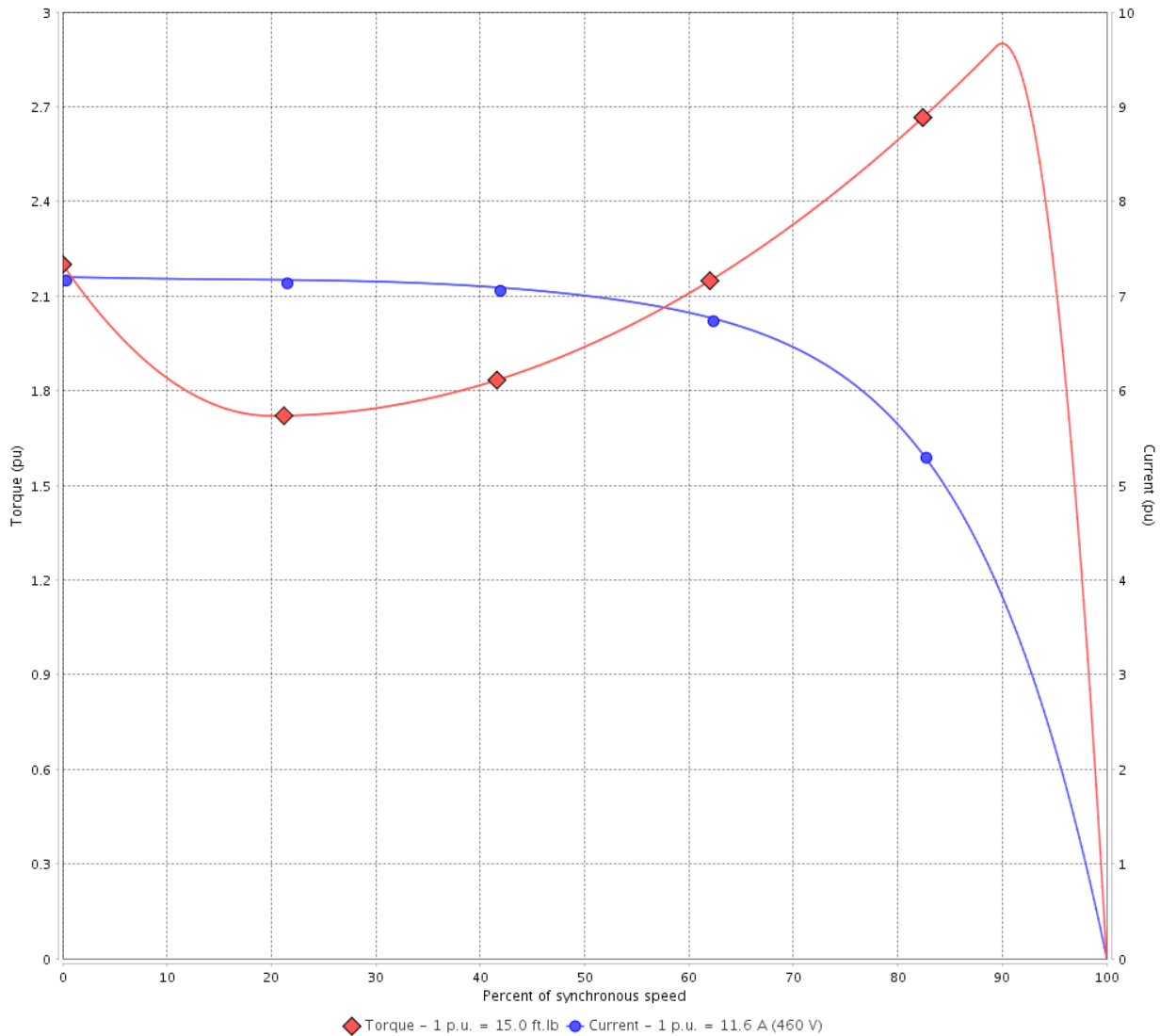

Performance : 230/460 V 60 Hz 2P

Rated current	: 23.2/11.6 A	Moment of inertia (J)	: 0.6362 sq.ft.lb
LRC	: 7.2	Duty cycle	: Cont.(S1)
Rated torque	: 15.0 ft.lb	Insulation class	: F
Locked rotor torque	: 220 %	Service factor	: 1.25
Breakdown torque	: 290 %	Temperature rise	: 80 K
Rated speed	: 3510 rpm	Design	: B

Locked rotor time : 43s (cold) 24s (hot)

Rev.	Changes Summary	Performed	Checked	Date
Performed by			Page 2 / 36	Revision
Checked by				
Date	12/04/2022			

TORQUE AND CURRENT VS SPEED CURVE



Three Phase Induction Motor - Squirrel Cage

Customer :

Product line : NEMA Premium Efficiency Three-Phase

Product code : 11441768

Catalog # : 01036ET3E215T-W22

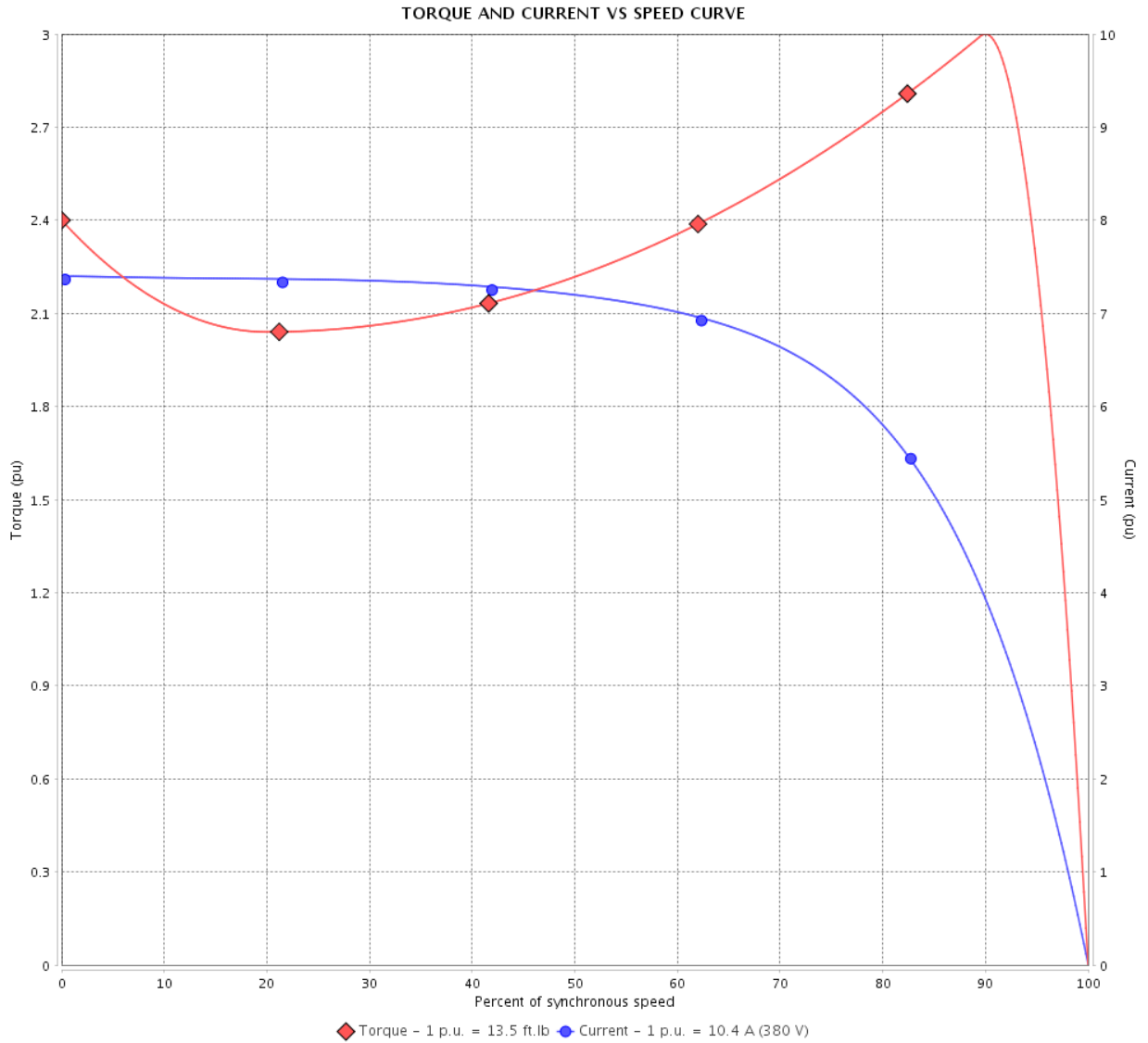

Performance : 380 V 50 Hz 2P IE3

Rated current	: 10.4 A	Moment of inertia (J)	: 0.6362 sq.ft.lb
LRC	: 7.4	Duty cycle	: Cont.(S1)
Rated torque	: 13.5 ft.lb	Insulation class	: F
Locked rotor torque	: 240 %	Service factor	: 1.25
Breakdown torque	: 300 %	Temperature rise	: 80 K
Rated speed	: 2925 rpm	Design	: B

Locked rotor time : 32s (cold) 18s (hot)

Rev.	Changes Summary	Performed	Checked	Date
Performed by		Page		Revision
Checked by		3 / 36		
Date	12/04/2022			

TORQUE AND CURRENT VS SPEED CURVE

Three Phase Induction Motor - Squirrel Cage



Customer :

Product line : NEMA Premium Efficiency Three-Phase

Product code : 11441768

Catalog # : 01036ET3E215T-W22

TORQUE AND CURRENT VS SPEED CURVE

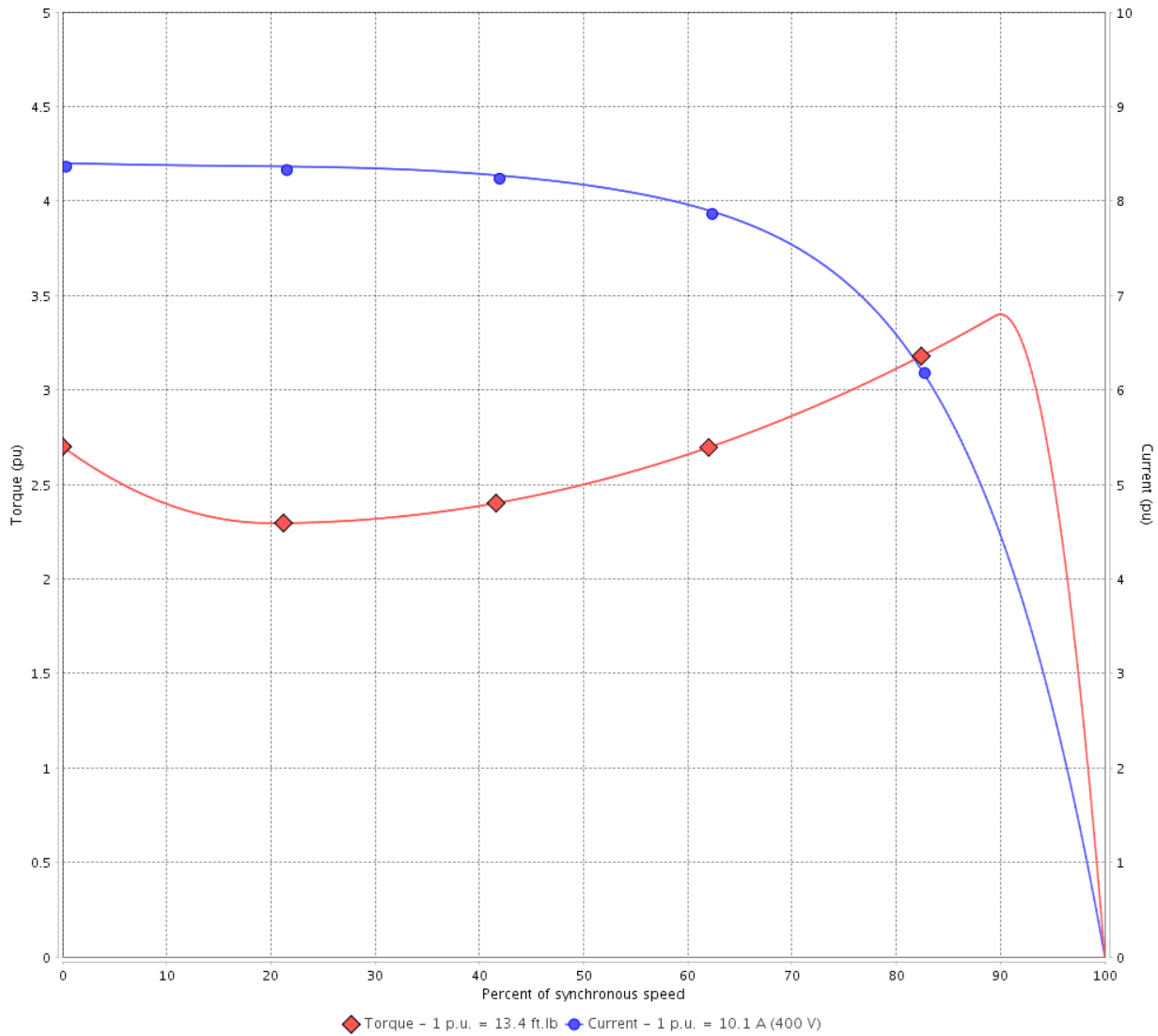

Performance : 400 V 50 Hz 2P IE3

Rated current	: 10.1 A	Moment of inertia (J)	: 0.6362 sq.ft.lb
LRC	: 8.4	Duty cycle	: Cont.(S1)
Rated torque	: 13.4 ft.lb	Insulation class	: F
Locked rotor torque	: 270 %	Service factor	: 1.25
Breakdown torque	: 340 %	Temperature rise	: 80 K
Rated speed	: 2935 rpm	Design	: B

Locked rotor time : 32s (cold) 18s (hot)

Rev.	Changes Summary	Performed	Checked	Date
Performed by			Page 4 / 36	Revision
Checked by				
Date	12/04/2022			

TORQUE AND CURRENT VS SPEED CURVE



Three Phase Induction Motor - Squirrel Cage

Customer :

Product line : NEMA Premium Efficiency Three-Phase

Product code : 11441768

Catalog # : 01036ET3E215T-W22

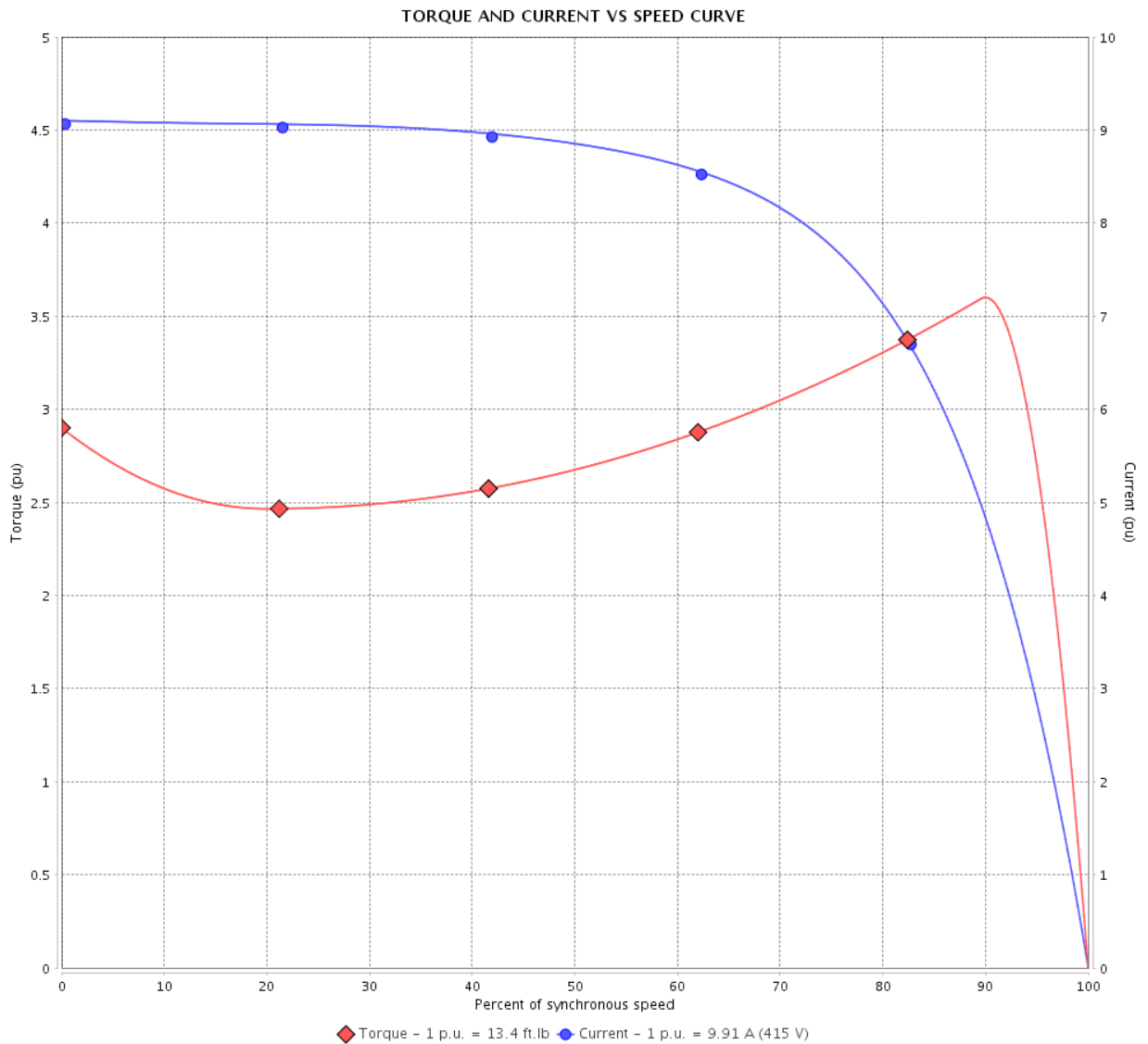

Performance : 415 V 50 Hz 2P IE3

Rated current	: 9.91 A	Moment of inertia (J)	: 0.6362 sq.ft.lb
LRC	: 9.1	Duty cycle	: Cont.(S1)
Rated torque	: 13.4 ft.lb	Insulation class	: F
Locked rotor torque	: 290 %	Service factor	: 1.25
Breakdown torque	: 360 %	Temperature rise	: 80 K
Rated speed	: 2940 rpm	Design	: B

Locked rotor time : 50s (cold) 28s (hot)

Rev.	Changes Summary	Performed	Checked	Date
Performed by			Page	Revision
Checked by			5 / 36	
Date	12/04/2022			

TORQUE AND CURRENT VS SPEED CURVE

Three Phase Induction Motor - Squirrel Cage



Customer :

Product line : NEMA Premium Efficiency Three-Phase

Product code : 11441768

Catalog # : 01036ET3E215T-W22

TORQUE AND CURRENT VS SPEED CURVE

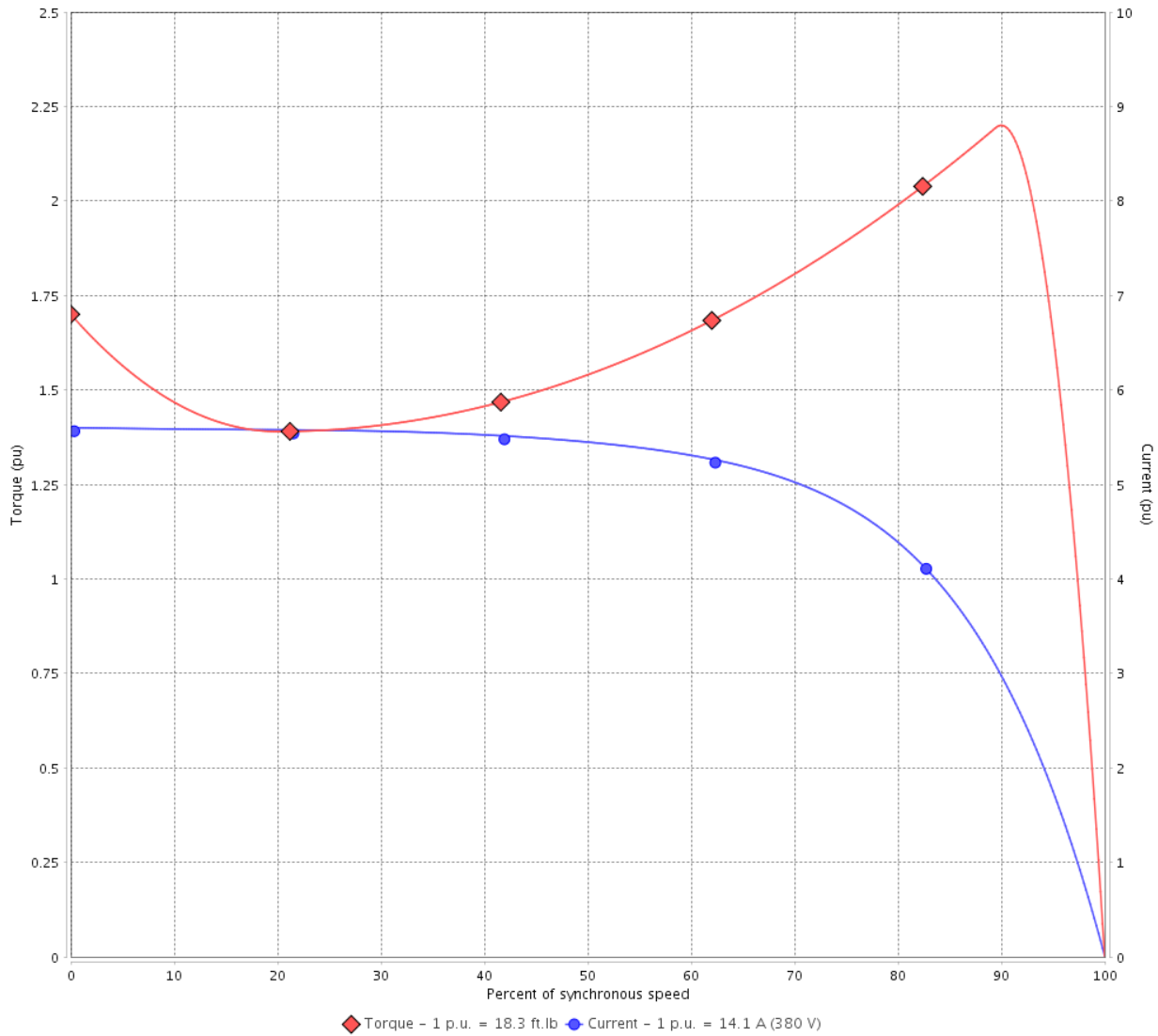

Performance : 380 V 50 Hz 2P IE2

Rated current	: 14.1 A	Moment of inertia (J)	: 0.6362 sq.ft.lb
LRC	: 5.6	Duty cycle	: Cont.(S1)
Rated torque	: 18.3 ft.lb	Insulation class	: F
Locked rotor torque	: 170 %	Service factor	: 1.00
Breakdown torque	: 220 %	Temperature rise	: 105 K
Rated speed	: 2870 rpm	Design	: B

Locked rotor time : 32s (cold) 18s (hot)

Rev.	Changes Summary	Performed	Checked	Date
Performed by			Page 6 / 36	Revision
Checked by				
Date	12/04/2022			

TORQUE AND CURRENT VS SPEED CURVE



Three Phase Induction Motor - Squirrel Cage

Customer :

Product line : NEMA Premium Efficiency Three-Phase

Product code : 11441768

Catalog # : 01036ET3E215T-W22

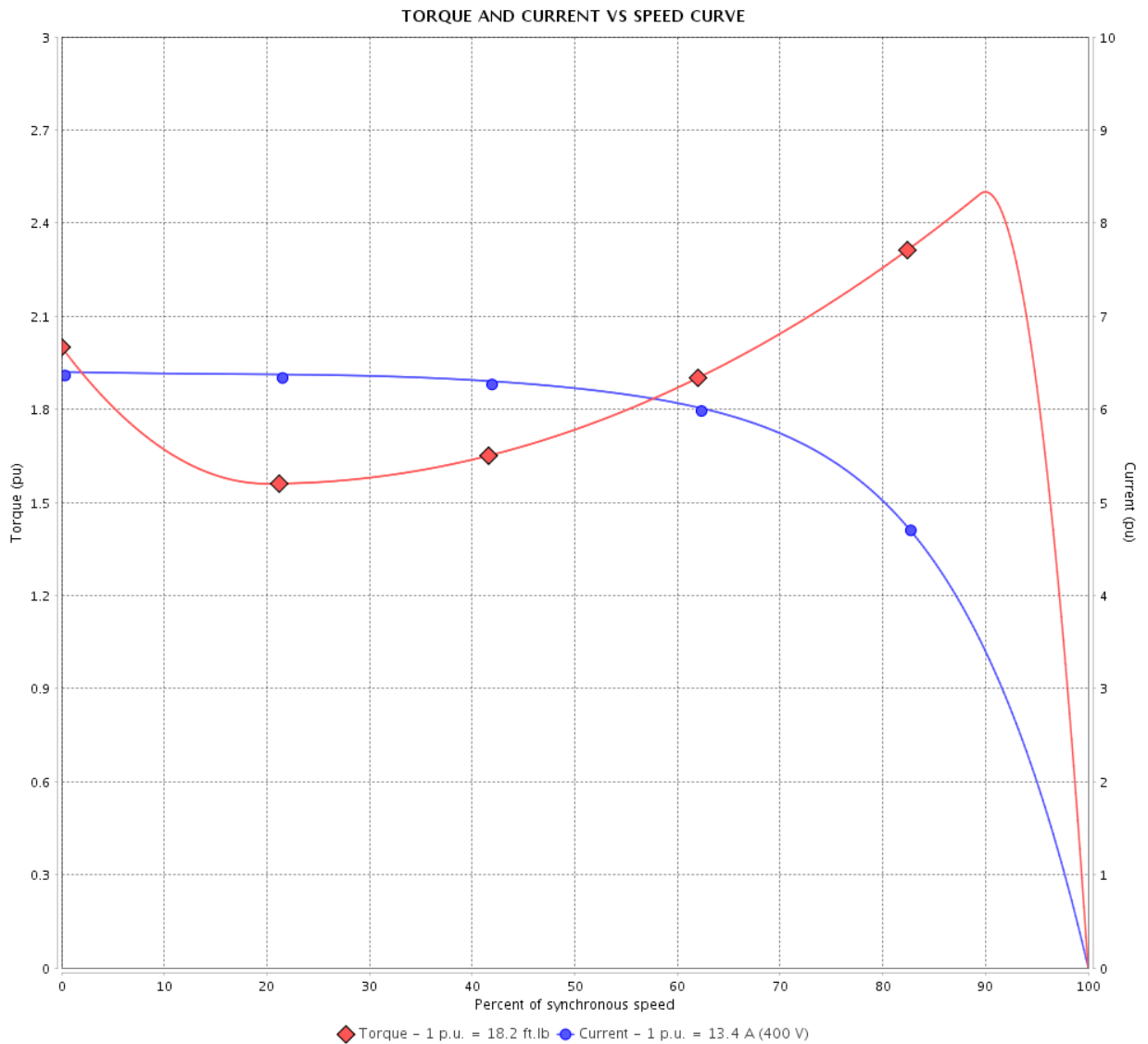

Performance : 400 V 50 Hz 2P IE2

Rated current	: 13.4 A	Moment of inertia (J)	: 0.6362 sq.ft.lb
LRC	: 6.4	Duty cycle	: Cont.(S1)
Rated torque	: 18.2 ft.lb	Insulation class	: F
Locked rotor torque	: 200 %	Service factor	: 1.00
Breakdown torque	: 250 %	Temperature rise	: 105 K
Rated speed	: 2890 rpm	Design	: B

Locked rotor time : 32s (cold) 18s (hot)

Rev.	Changes Summary	Performed	Checked	Date
Performed by			Page 7 / 36	Revision
Checked by				
Date	12/04/2022			

TORQUE AND CURRENT VS SPEED CURVE

Three Phase Induction Motor - Squirrel Cage



Customer :

Product line : NEMA Premium Efficiency Three-Phase

Product code : 11441768

Catalog # : 01036ET3E215T-W22

TORQUE AND CURRENT VS SPEED CURVE

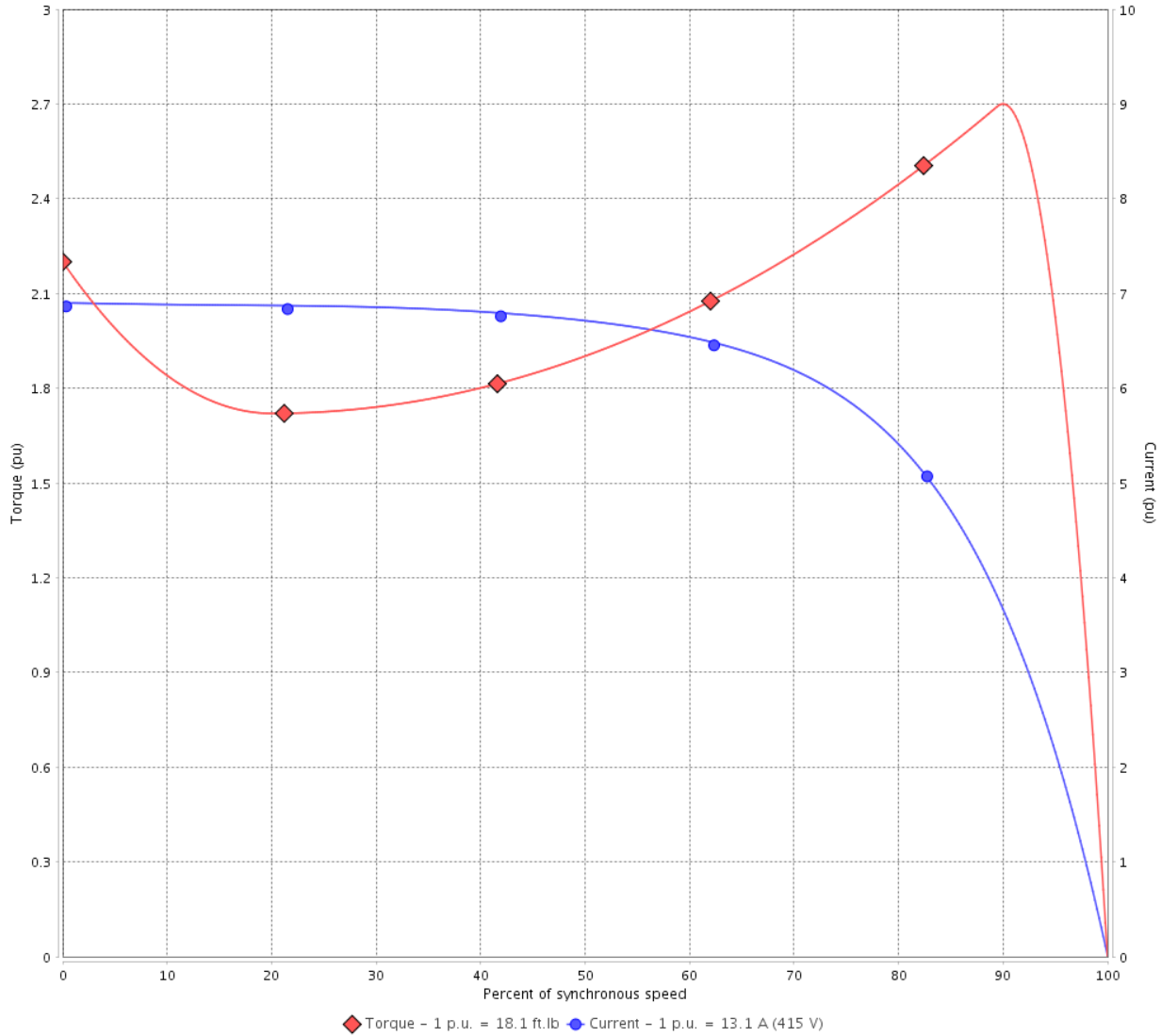

Performance : 415 V 50 Hz 2P IE2

Rated current	: 13.1 A	Moment of inertia (J)	: 0.6362 sq.ft.lb
LRC	: 6.9	Duty cycle	: Cont.(S1)
Rated torque	: 18.1 ft.lb	Insulation class	: F
Locked rotor torque	: 220 %	Service factor	: 1.00
Breakdown torque	: 270 %	Temperature rise	: 105 K
Rated speed	: 2900 rpm	Design	: B

Locked rotor time : 32s (cold) 18s (hot)

Rev.	Changes Summary	Performed	Checked	Date
Performed by			Page 8 / 36	Revision
Checked by				
Date	12/04/2022			

LOAD PERFORMANCE CURVE

Three Phase Induction Motor - Squirrel Cage



Customer : _____

Product line : NEMA Premium Efficiency Three-Phase

Product code : 11441768

Catalog # : 01036ET3E215T-W22

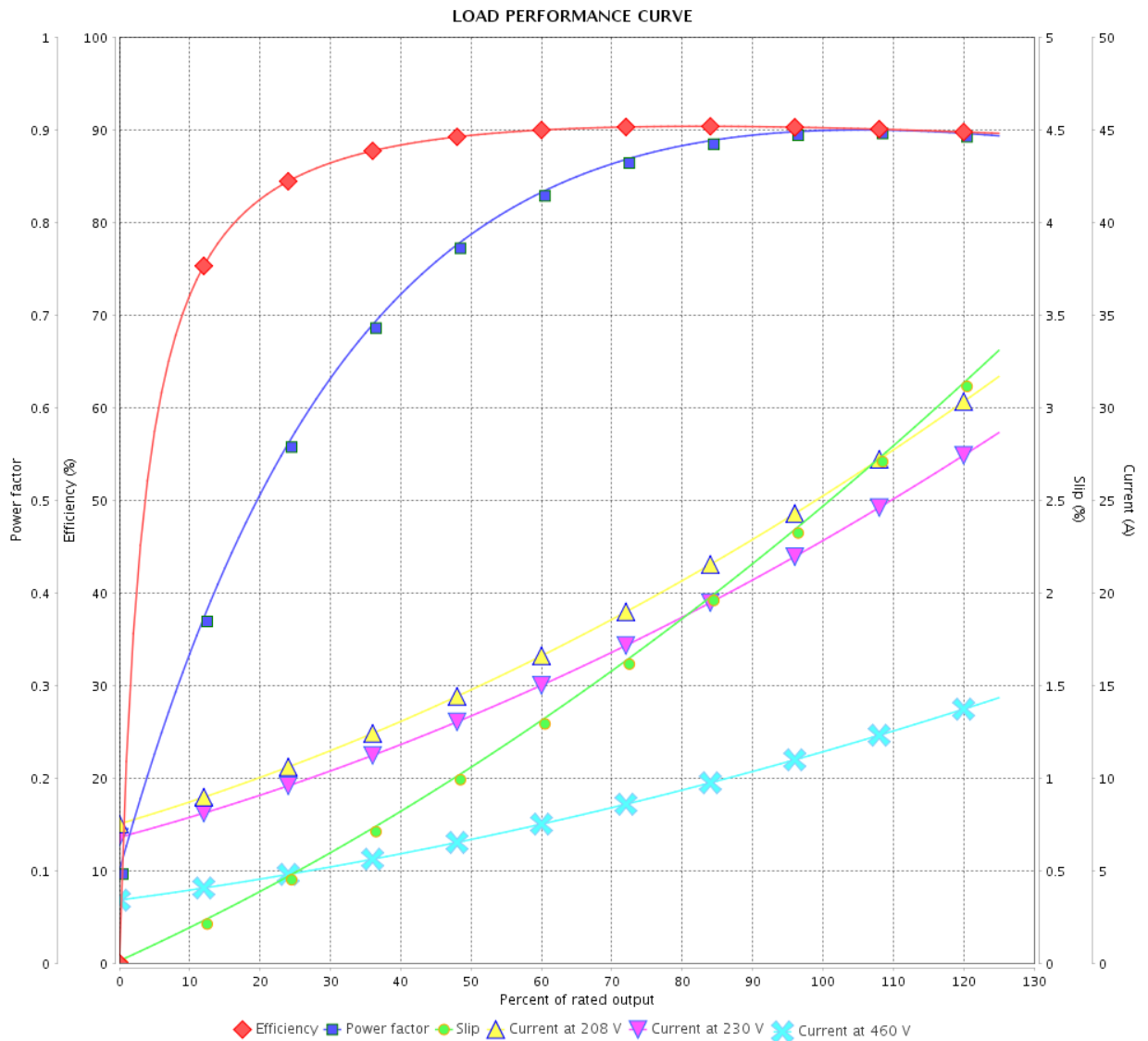

Performance : 230/460 V 60 Hz 2P

Rated current : 23.2/11.6 A
 LRC : 7.2
 Rated torque : 15.0 ft.lb
 Locked rotor torque : 220 %
 Breakdown torque : 290 %
 Rated speed : 3510 rpm

Moment of inertia (J) : 0.6362 sq.ft.lb
 Duty cycle : Cont.(S1)
 Insulation class : F
 Service factor : 1.25
 Temperature rise : 80 K
 Design : B

Rev.	Changes Summary	Performed	Checked	Date
Performed by			Page	Revision
Checked by				
Date				

LOAD PERFORMANCE CURVE

Three Phase Induction Motor - Squirrel Cage



Customer :

Product line : NEMA Premium Efficiency Three-Phase

Product code : 11441768

Catalog # : 01036ET3E215T-W22

LOAD PERFORMANCE CURVE

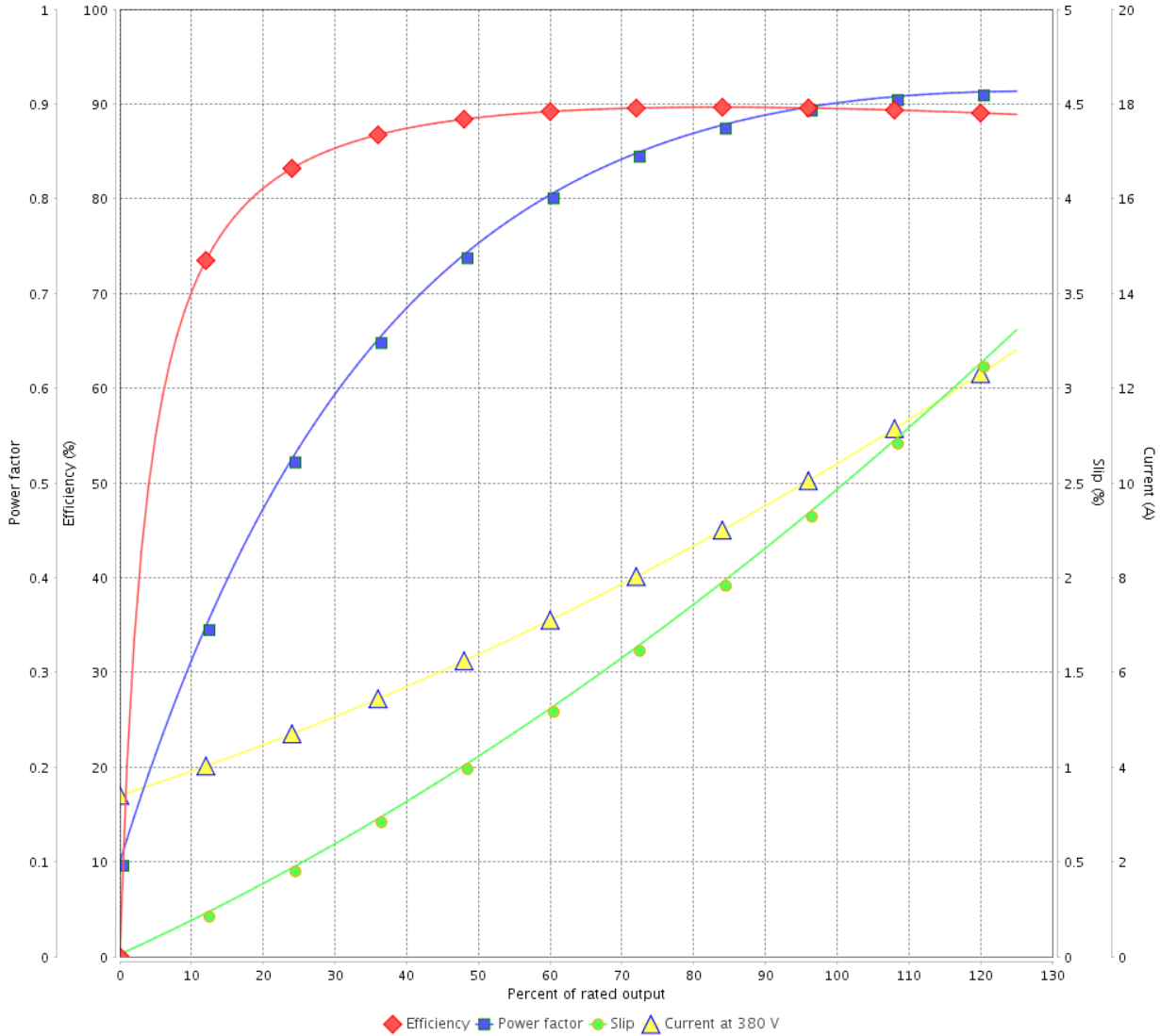

Performance : 380 V 50 Hz 2P IE3

Rated current : 10.4 A
 LRC : 7.4
 Rated torque : 13.5 ft.lb
 Locked rotor torque : 240 %
 Breakdown torque : 300 %
 Rated speed : 2925 rpm

Moment of inertia (J) : 0.6362 sq.ft.lb
 Duty cycle : Cont.(S1)
 Insulation class : F
 Service factor : 1.25
 Temperature rise : 80 K
 Design : B

Rev.	Changes Summary	Performed	Checked	Date
Performed by			Page 10 / 36	Revision
Checked by				
Date	12/04/2022			

LOAD PERFORMANCE CURVE

Three Phase Induction Motor - Squirrel Cage



Customer :

Product line : NEMA Premium Efficiency Three-Phase

Product code : 11441768

Catalog # : 01036ET3E215T-W22

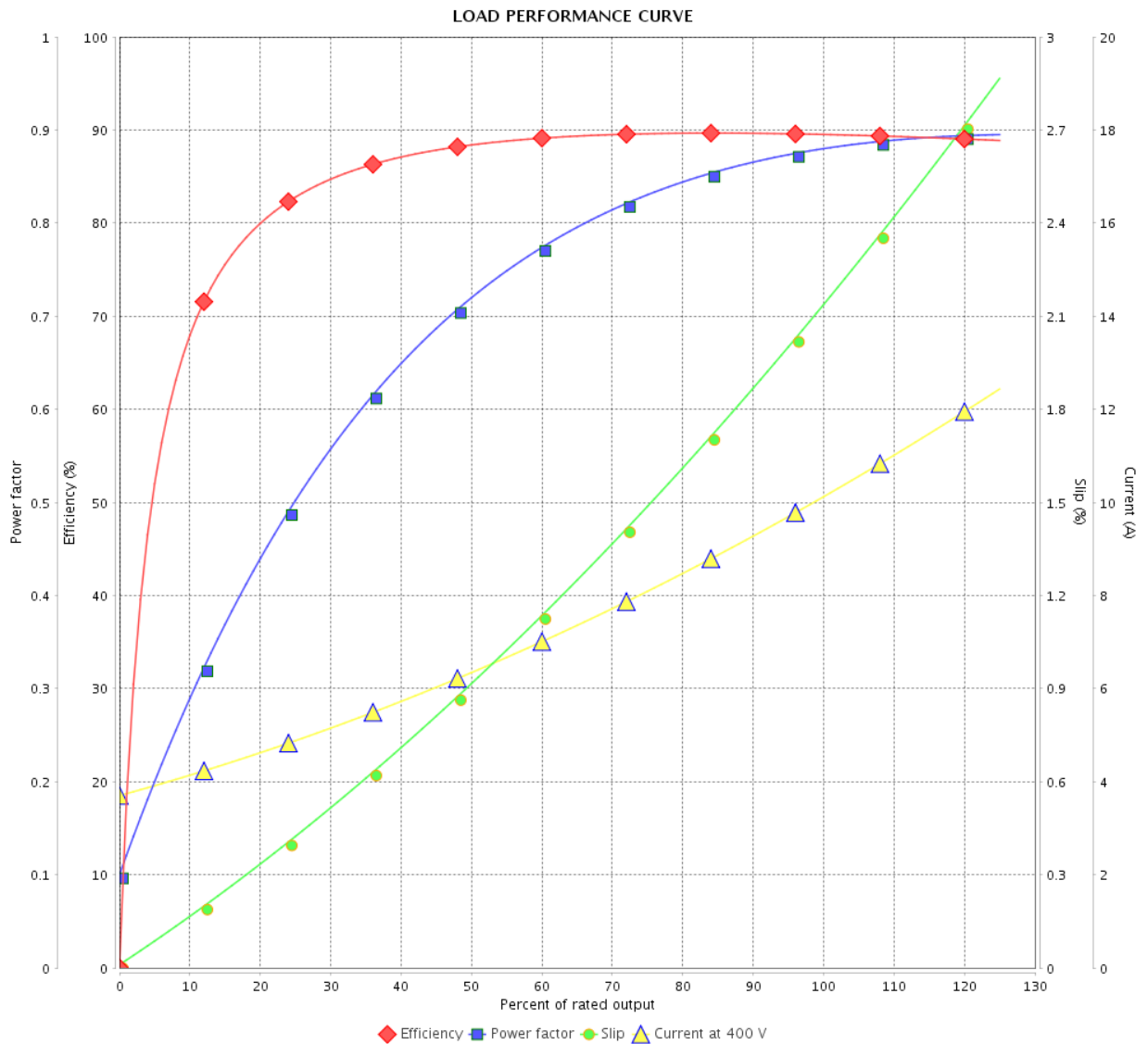

Performance : 400 V 50 Hz 2P IE3

Rated current : 10.1 A
 LRC : 8.4
 Rated torque : 13.4 ft.lb
 Locked rotor torque : 270 %
 Breakdown torque : 340 %
 Rated speed : 2935 rpm

Moment of inertia (J) : 0.6362 sq.ft.lb
 Duty cycle : Cont.(S1)
 Insulation class : F
 Service factor : 1.25
 Temperature rise : 80 K
 Design : B

Rev.	Changes Summary	Performed	Checked	Date
Performed by			Page	Revision
Checked by			11 / 36	
Date	12/04/2022			

LOAD PERFORMANCE CURVE

Three Phase Induction Motor - Squirrel Cage



Customer :

Product line : NEMA Premium Efficiency Three-Phase

Product code : 11441768

Catalog # : 01036ET3E215T-W22

LOAD PERFORMANCE CURVE

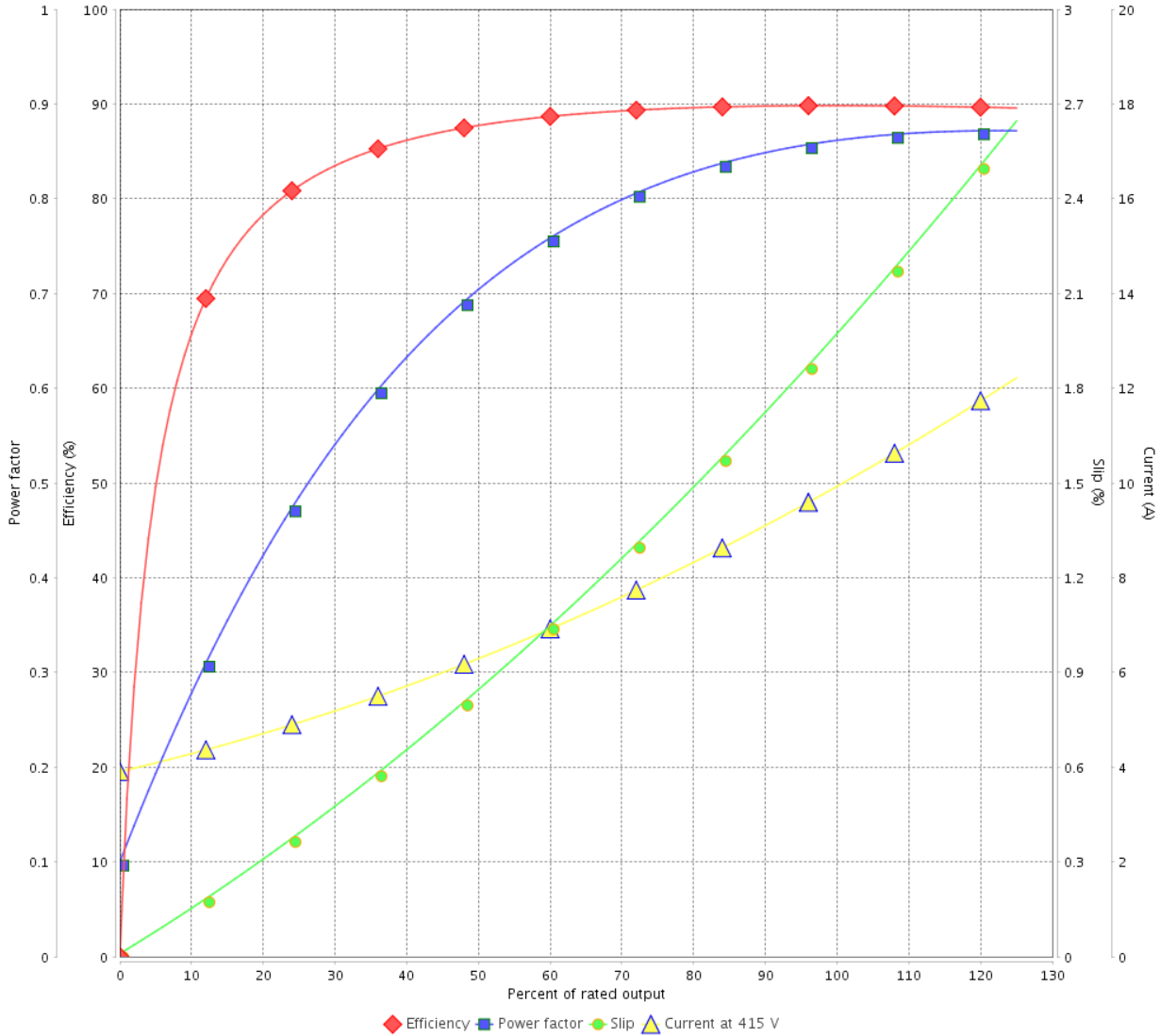

Performance : 415 V 50 Hz 2P IE3

Rated current : 9.91 A
 LRC : 9.1
 Rated torque : 13.4 ft.lb
 Locked rotor torque : 290 %
 Breakdown torque : 360 %
 Rated speed : 2940 rpm

Moment of inertia (J) : 0.6362 sq.ft.lb
 Duty cycle : Cont.(S1)
 Insulation class : F
 Service factor : 1.25
 Temperature rise : 80 K
 Design : B

Rev.	Changes Summary	Performed	Checked	Date
Performed by		Page		Revision
Checked by		12 / 36		
Date	12/04/2022			

LOAD PERFORMANCE CURVE

Three Phase Induction Motor - Squirrel Cage



Customer : _____

Product line : NEMA Premium Efficiency Three-Phase

Product code : 11441768

Catalog # : 01036ET3E215T-W22

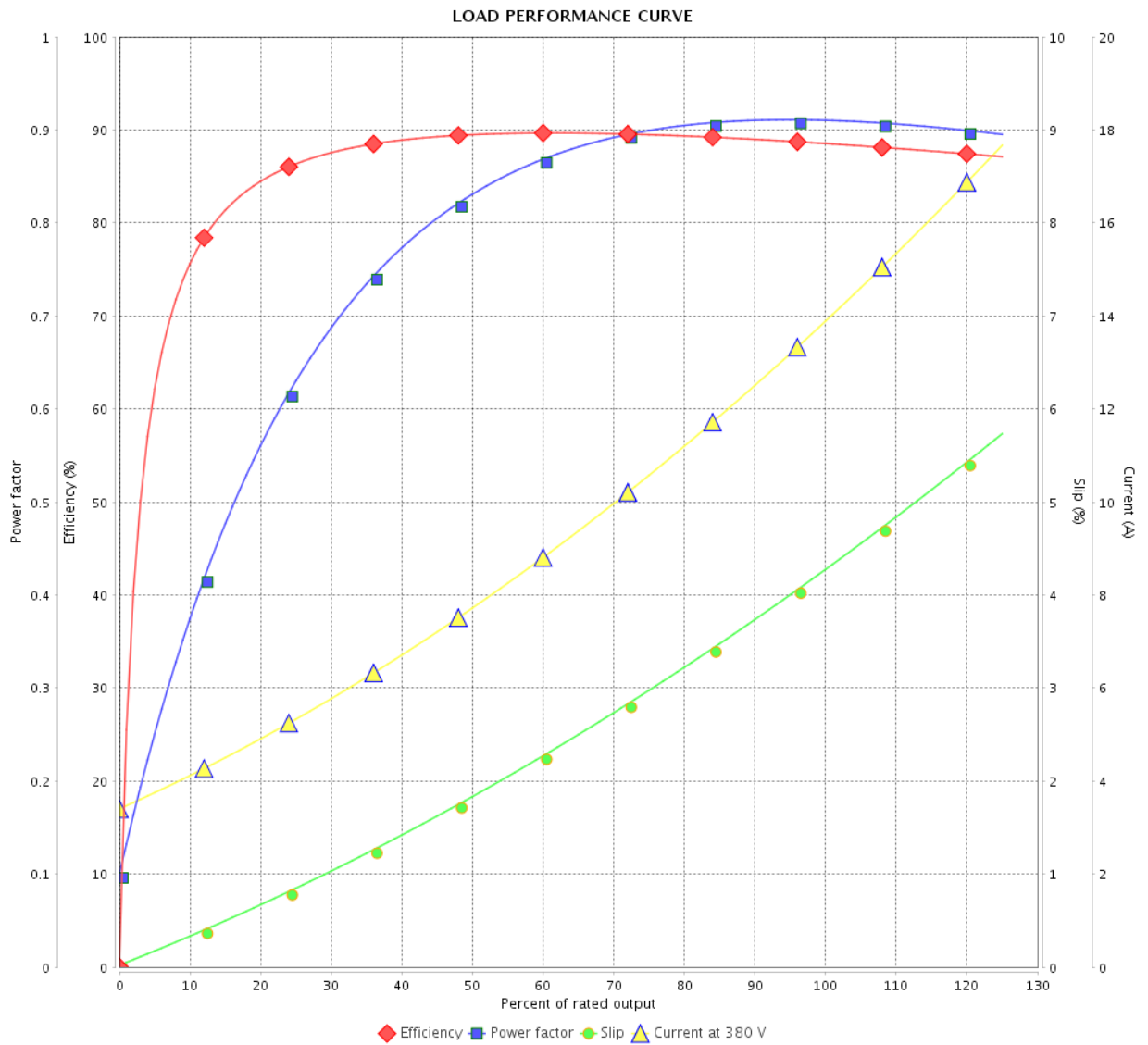

Performance : 380 V 50 Hz 2P IE2

Rated current : 14.1 A
 LRC : 5.6
 Rated torque : 18.3 ft.lb
 Locked rotor torque : 170 %
 Breakdown torque : 220 %
 Rated speed : 2870 rpm

Moment of inertia (J) : 0.6362 sq.ft.lb
 Duty cycle : Cont.(S1)
 Insulation class : F
 Service factor : 1.00
 Temperature rise : 105 K
 Design : B

Rev.	Changes Summary	Performed	Checked	Date
Performed by		Page		Revision
Checked by		13 / 36		
Date		12/04/2022		

LOAD PERFORMANCE CURVE

Three Phase Induction Motor - Squirrel Cage



Customer :

Product line : NEMA Premium Efficiency Three-Phase

Product code : 11441768

Catalog # : 01036ET3E215T-W22

LOAD PERFORMANCE CURVE

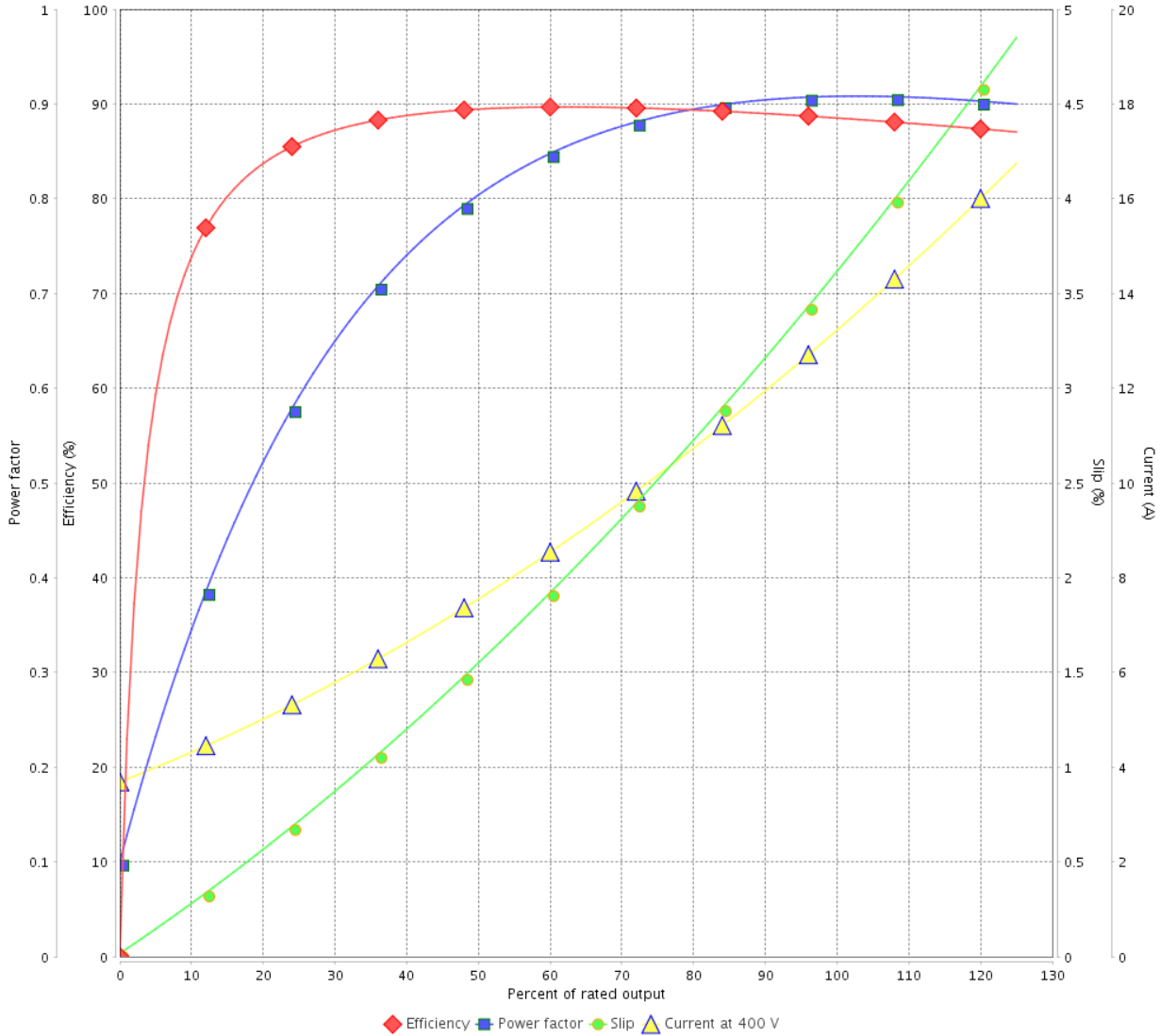

Performance : 400 V 50 Hz 2P IE2

Rated current : 13.4 A
 LRC : 6.4
 Rated torque : 18.2 ft.lb
 Locked rotor torque : 200 %
 Breakdown torque : 250 %
 Rated speed : 2890 rpm

Moment of inertia (J) : 0.6362 sq.ft.lb
 Duty cycle : Cont.(S1)
 Insulation class : F
 Service factor : 1.00
 Temperature rise : 105 K
 Design : B

Rev.	Changes Summary	Performed	Checked	Date
Performed by			Page 14 / 36	Revision
Checked by				
Date	12/04/2022			

LOAD PERFORMANCE CURVE

Three Phase Induction Motor - Squirrel Cage



Customer : _____

Product line : NEMA Premium Efficiency Three-Phase

Product code : 11441768

Catalog # : 01036ET3E215T-W22

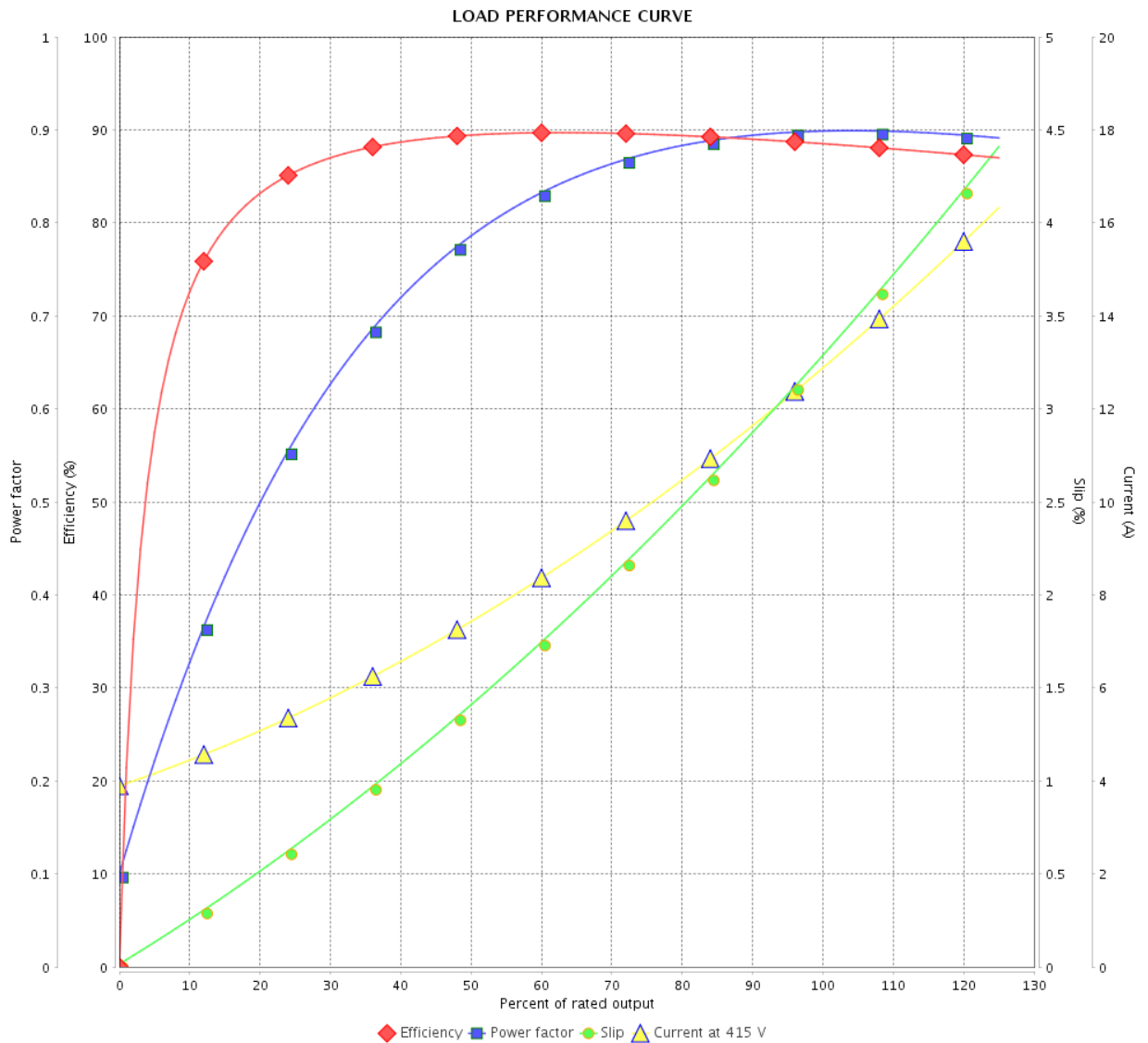

Performance : 415 V 50 Hz 2P IE2

Rated current : 13.1 A
 LRC : 6.9
 Rated torque : 18.1 ft.lb
 Locked rotor torque : 220 %
 Breakdown torque : 270 %
 Rated speed : 2900 rpm

Moment of inertia (J) : 0.6362 sq.ft.lb
 Duty cycle : Cont.(S1)
 Insulation class : F
 Service factor : 1.00
 Temperature rise : 105 K
 Design : B

Rev.	Changes Summary	Performed	Checked	Date
Performed by		Page		Revision
Checked by		15 / 36		
Date		12/04/2022		

THERMAL LIMIT CURVE



Three Phase Induction Motor - Squirrel Cage

Customer :

Product line : NEMA Premium Efficiency Three-Phase
 Product code : 11441768
 Catalog # : 01036ET3E215T-W22

Performance : 230/460 V 60 Hz 2P

Rated current : 23.2/11.6 A	Moment of inertia (J) : 0.6362 sq.ft.lb
LRC : 7.2	Duty cycle : Cont.(S1)
Rated torque : 15.0 ft.lb	Insulation class : F
Locked rotor torque : 220 %	Service factor : 1.25
Breakdown torque : 290 %	Temperature rise : 80 K
Rated speed : 3510 rpm	Design : B

Heating constant

Cooling constant

Rev.	Changes Summary	Performed	Checked	Date
Performed by			Page 16 / 36	Revision
Checked by				
Date	12/04/2022			

THERMAL LIMIT CURVE

Three Phase Induction Motor - Squirrel Cage



Customer : _____

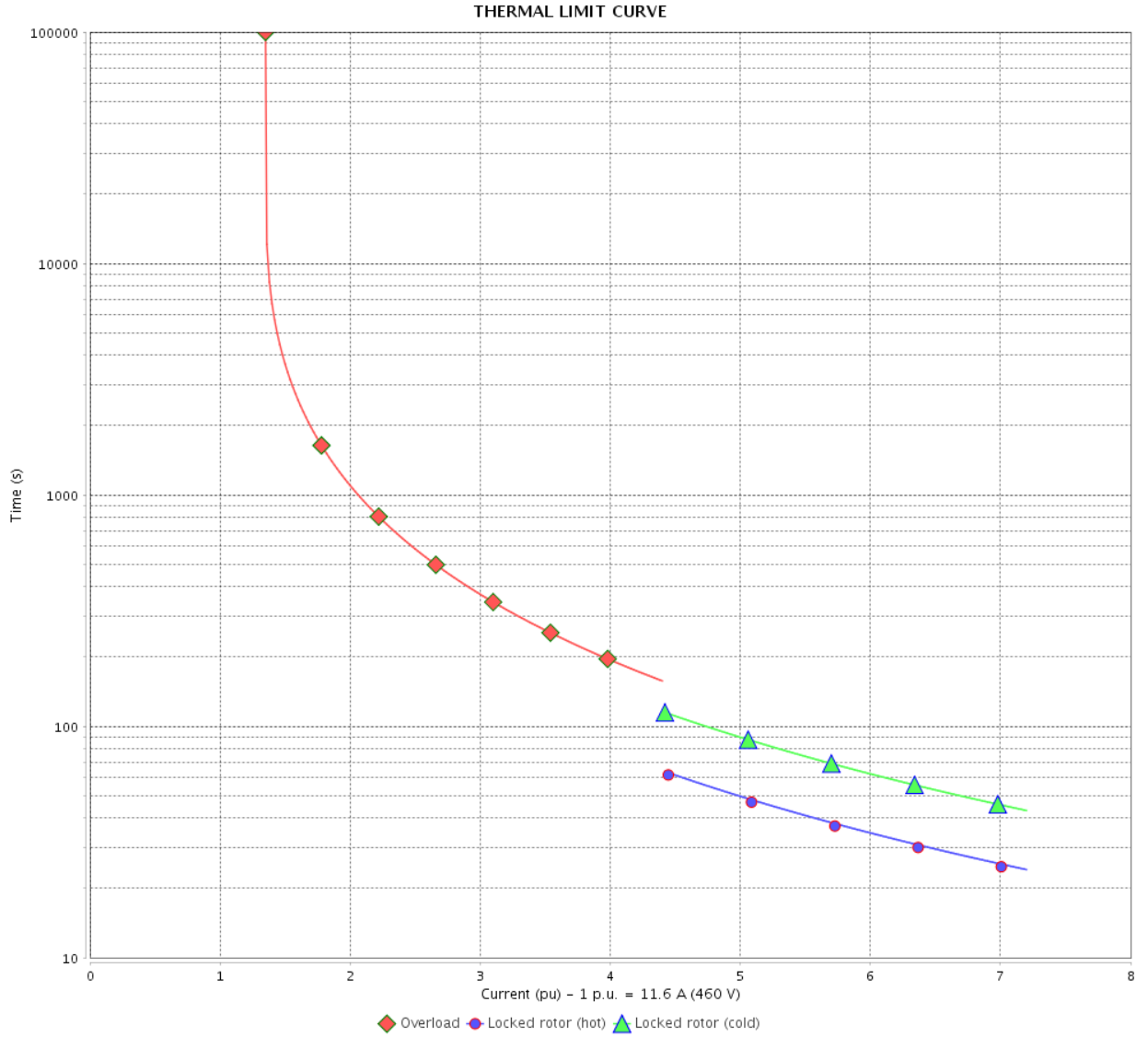

Rev.	Changes Summary	Performed	Checked	Date
Performed by		Page 17 / 36		Revision
Checked by				
Date				

THERMAL LIMIT CURVE



Three Phase Induction Motor - Squirrel Cage

Customer :

Product line : NEMA Premium Efficiency Three-Phase
Product code : 11441768
Catalog # : 01036ET3E215T-W22

Performance : 380 V 50 Hz 2P IE3

Rated current : 10.4 A	Moment of inertia (J) : 0.6362 sq.ft.lb
LRC : 7.4	Duty cycle : Cont.(S1)
Rated torque : 13.5 ft.lb	Insulation class : F
Locked rotor torque : 240 %	Service factor : 1.25
Breakdown torque : 300 %	Temperature rise : 80 K
Rated speed : 2925 rpm	Design : B

Heating constant

Cooling constant

Rev.	Changes Summary	Performed	Checked	Date
Performed by			Page	Revision
Checked by			18 / 36	
Date	12/04/2022			

THERMAL LIMIT CURVE

Three Phase Induction Motor - Squirrel Cage



Customer : _____

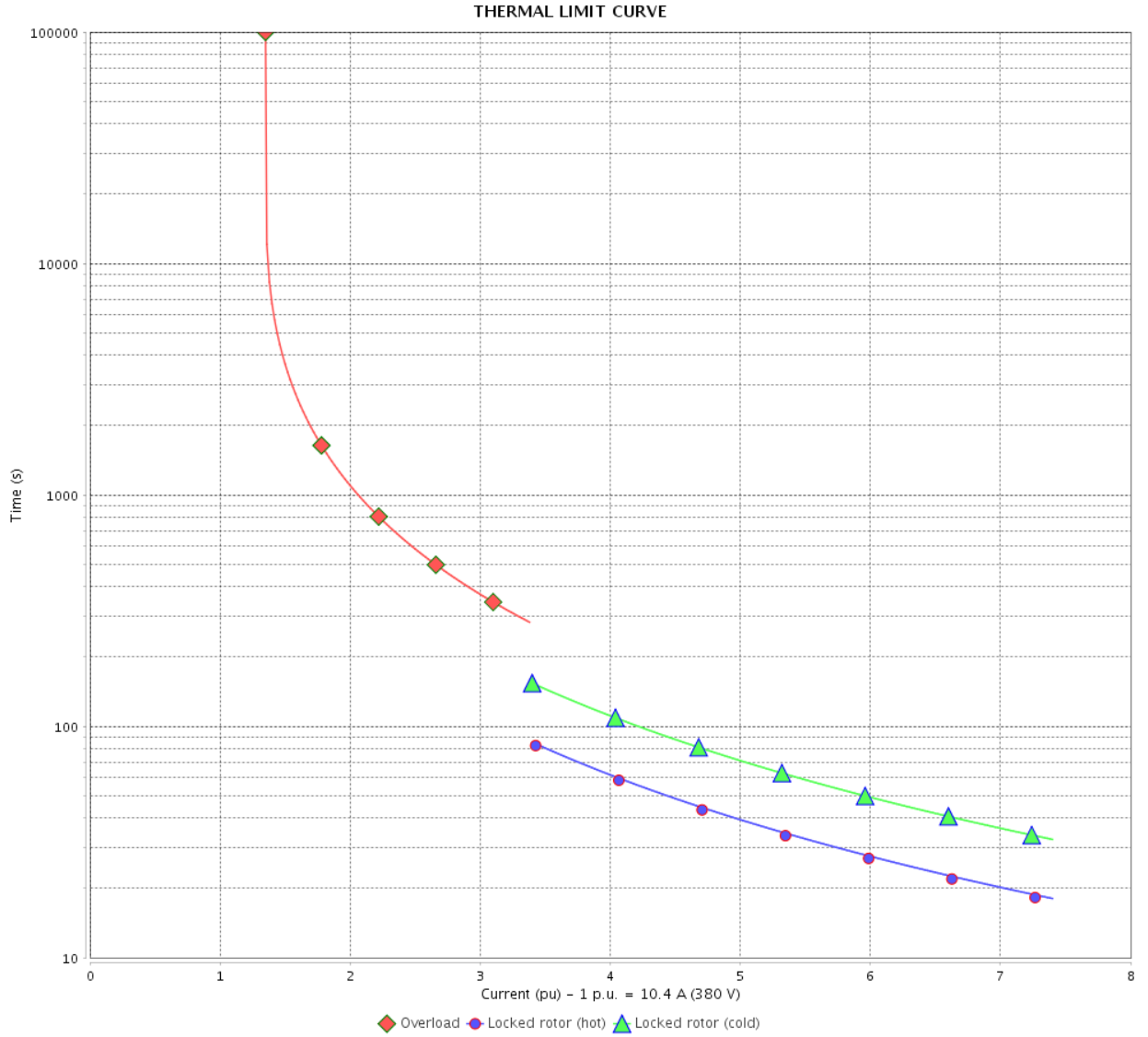

Rev.	Changes Summary	Performed	Checked	Date
Performed by		Page 19 / 36		Revision
Checked by				
Date				

THERMAL LIMIT CURVE



Three Phase Induction Motor - Squirrel Cage

Customer :

Product line : NEMA Premium Efficiency Three-Phase
 Product code : 11441768
 Catalog # : 01036ET3E215T-W22

Performance : 400 V 50 Hz 2P IE3

Rated current : 10.1 A	Moment of inertia (J) : 0.6362 sq.ft.lb
LRC : 8.4	Duty cycle : Cont.(S1)
Rated torque : 13.4 ft.lb	Insulation class : F
Locked rotor torque : 270 %	Service factor : 1.25
Breakdown torque : 340 %	Temperature rise : 80 K
Rated speed : 2935 rpm	Design : B

Heating constant

Cooling constant

Rev.	Changes Summary	Performed	Checked	Date
Performed by			Page 20 / 36	Revision
Checked by				
Date	12/04/2022			

THERMAL LIMIT CURVE

Three Phase Induction Motor - Squirrel Cage



Customer : _____

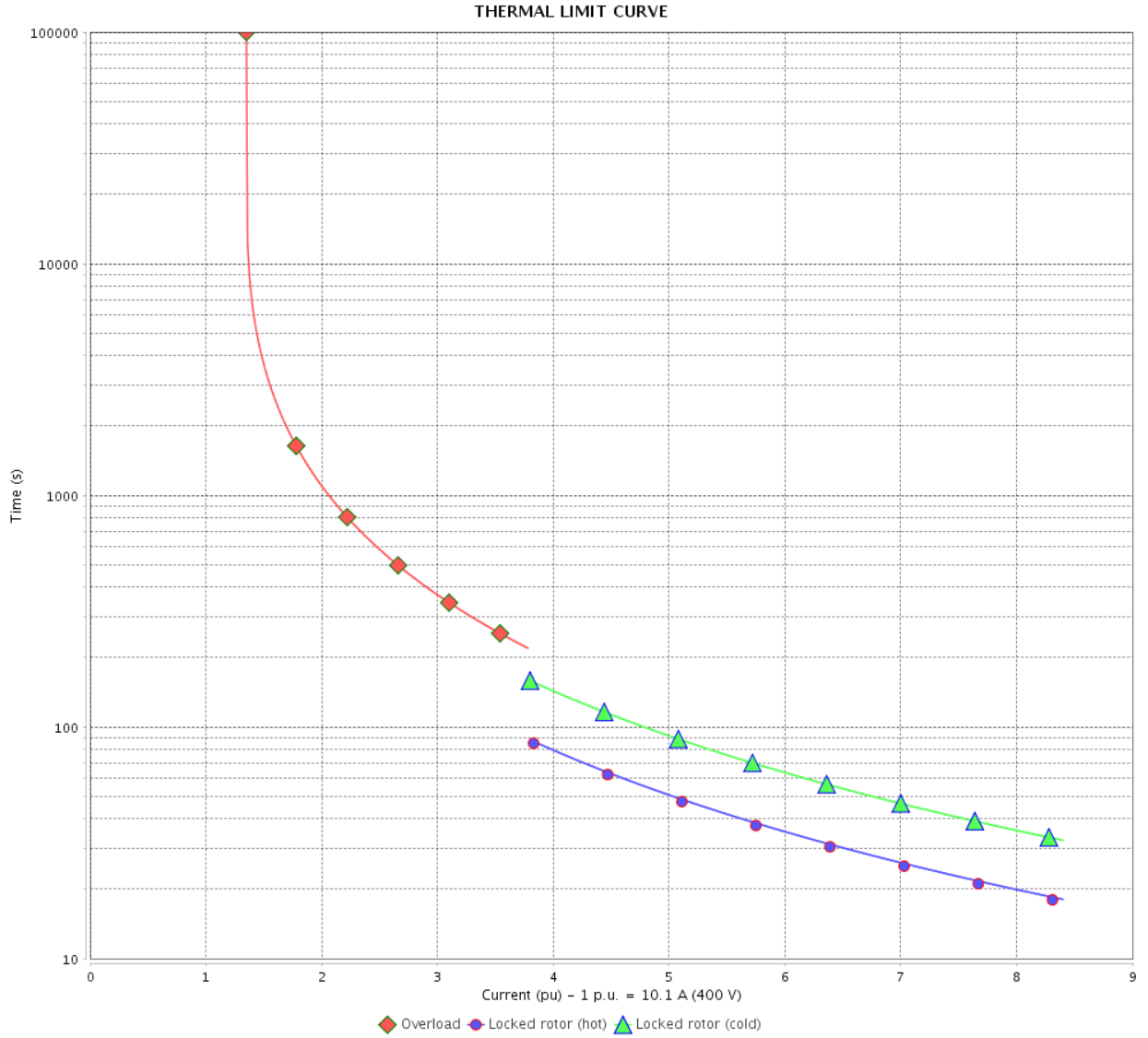

Rev.	Changes Summary	Performed	Checked	Date
Performed by		Page		Revision
Checked by		21 / 36		
Date		12/04/2022		

THERMAL LIMIT CURVE



Three Phase Induction Motor - Squirrel Cage

Customer :

Product line : NEMA Premium Efficiency Three-Phase
Product code : 11441768
Catalog # : 01036ET3E215T-W22

Performance : 415 V 50 Hz 2P IE3

Rated current	: 9.91 A	Moment of inertia (J)	: 0.6362 sq.ft.lb
LRC	: 9.1	Duty cycle	: Cont.(S1)
Rated torque	: 13.4 ft.lb	Insulation class	: F
Locked rotor torque	: 290 %	Service factor	: 1.25
Breakdown torque	: 360 %	Temperature rise	: 80 K
Rated speed	: 2940 rpm	Design	: B

Heating constant

Cooling constant

Rev.	Changes Summary	Performed	Checked	Date
Performed by				
Checked by			Page	Revision
Date	12/04/2022		22 / 36	

THERMAL LIMIT CURVE

Three Phase Induction Motor - Squirrel Cage



Customer : _____

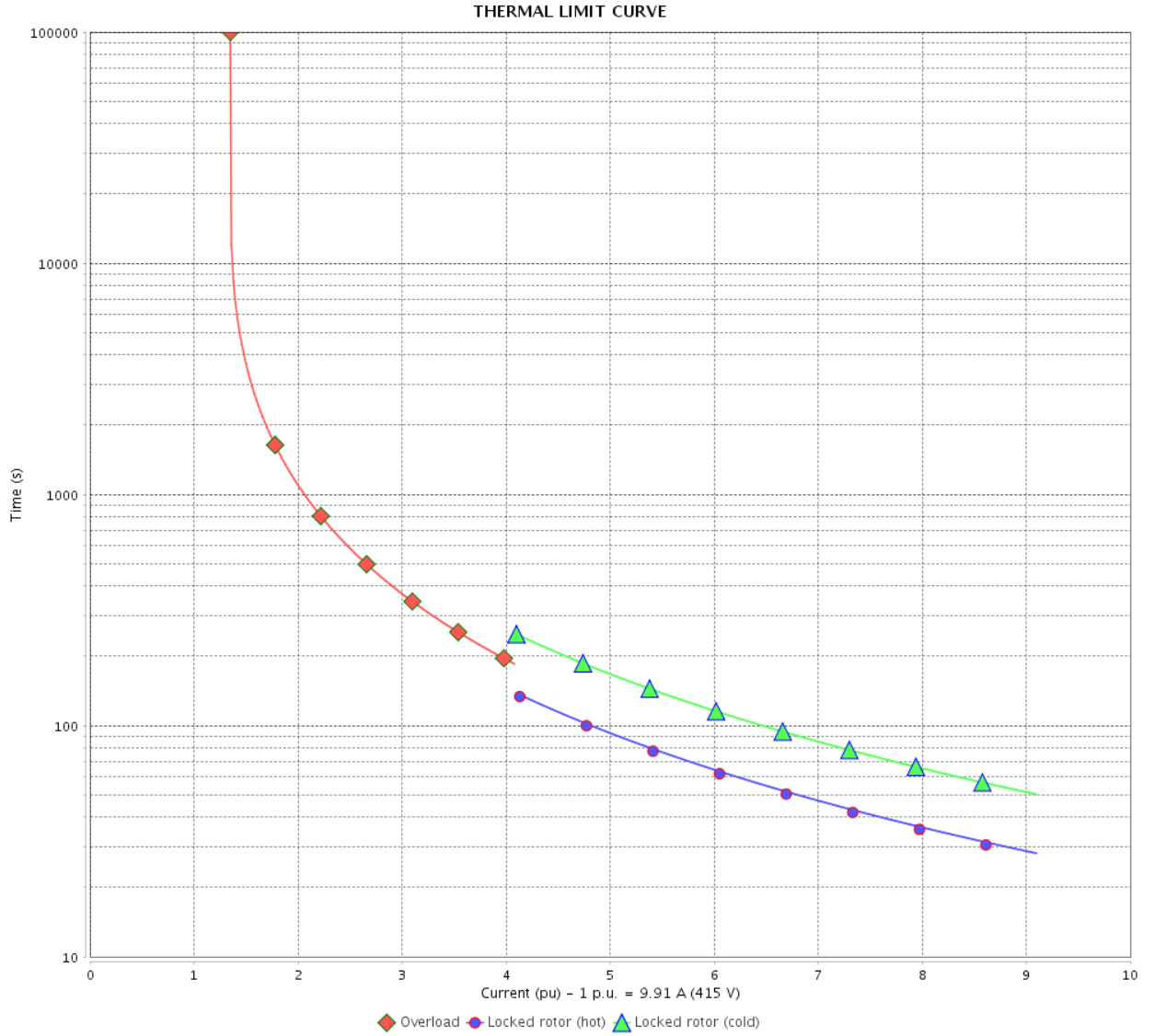

Rev.	Changes Summary	Performed	Checked	Date
Performed by		Page		Revision
Checked by		23 / 36		
Date		12/04/2022		

THERMAL LIMIT CURVE



Three Phase Induction Motor - Squirrel Cage

Customer :

Product line : NEMA Premium Efficiency Three-Phase
Product code : 11441768
Catalog # : 01036ET3E215T-W22

Performance : 380 V 50 Hz 2P IE2

Rated current	: 14.1 A	Moment of inertia (J)	: 0.6362 sq.ft.lb
LRC	: 5.6	Duty cycle	: Cont.(S1)
Rated torque	: 18.3 ft.lb	Insulation class	: F
Locked rotor torque	: 170 %	Service factor	: 1.00
Breakdown torque	: 220 %	Temperature rise	: 105 K
Rated speed	: 2870 rpm	Design	: B

Heating constant

Cooling constant

Rev.	Changes Summary	Performed	Checked	Date
Performed by				
Checked by			Page	Revision
Date	12/04/2022		24 / 36	

THERMAL LIMIT CURVE

Three Phase Induction Motor - Squirrel Cage



Customer : _____

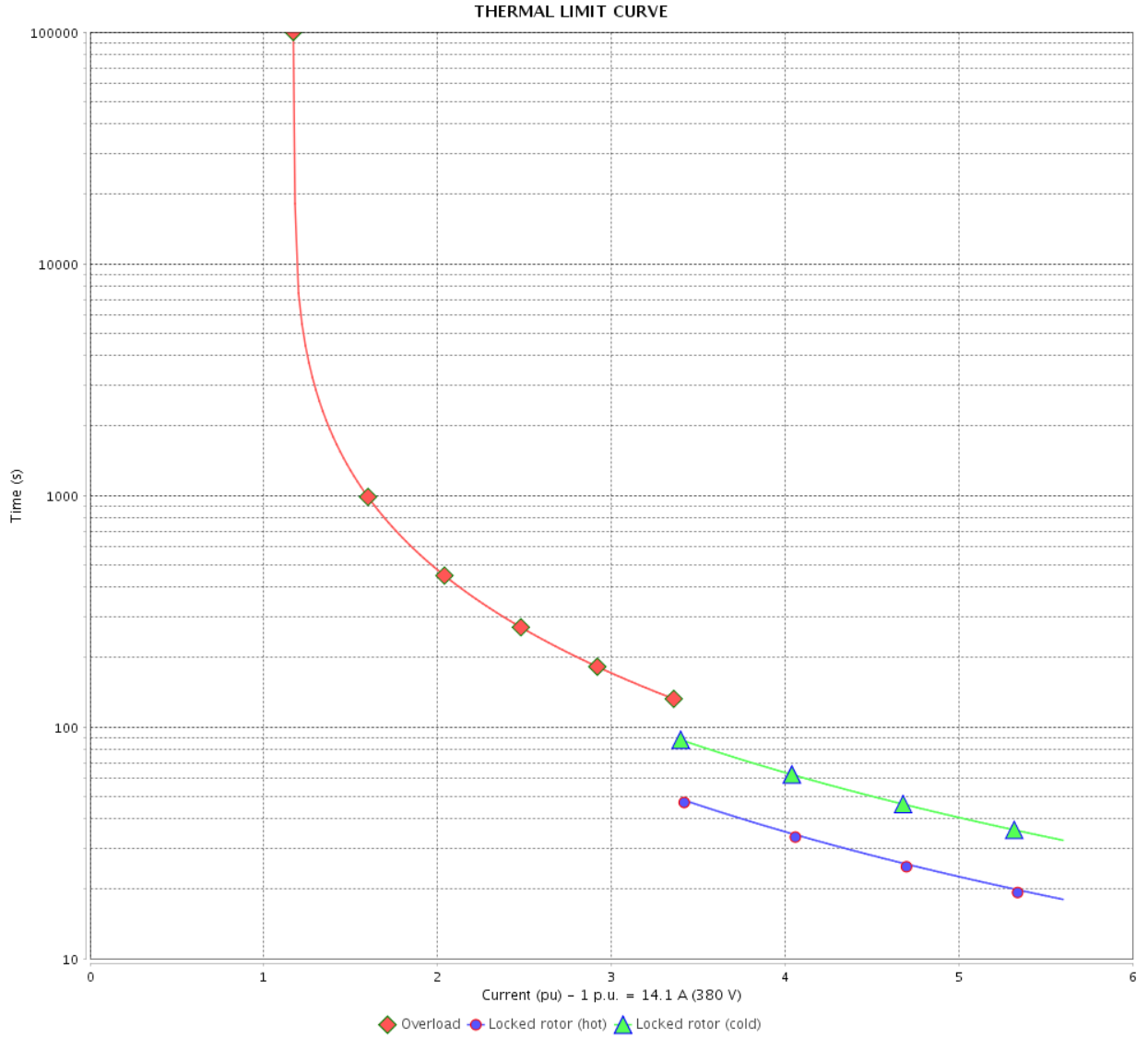

Rev.	Changes Summary	Performed	Checked	Date
Performed by		Page 25 / 36		Revision
Checked by				
Date				

THERMAL LIMIT CURVE



Three Phase Induction Motor - Squirrel Cage

Customer :

Product line : NEMA Premium Efficiency Three-Phase
 Product code : 11441768
 Catalog # : 01036ET3E215T-W22

Performance : 400 V 50 Hz 2P IE2

Rated current : 13.4 A	Moment of inertia (J) : 0.6362 sq.ft.lb
LRC : 6.4	Duty cycle : Cont.(S1)
Rated torque : 18.2 ft.lb	Insulation class : F
Locked rotor torque : 200 %	Service factor : 1.00
Breakdown torque : 250 %	Temperature rise : 105 K
Rated speed : 2890 rpm	Design : B

Heating constant

Cooling constant

Rev.	Changes Summary	Performed	Checked	Date
Performed by			Page 26 / 36	Revision
Checked by				
Date	12/04/2022			

THERMAL LIMIT CURVE

Three Phase Induction Motor - Squirrel Cage



Customer : _____

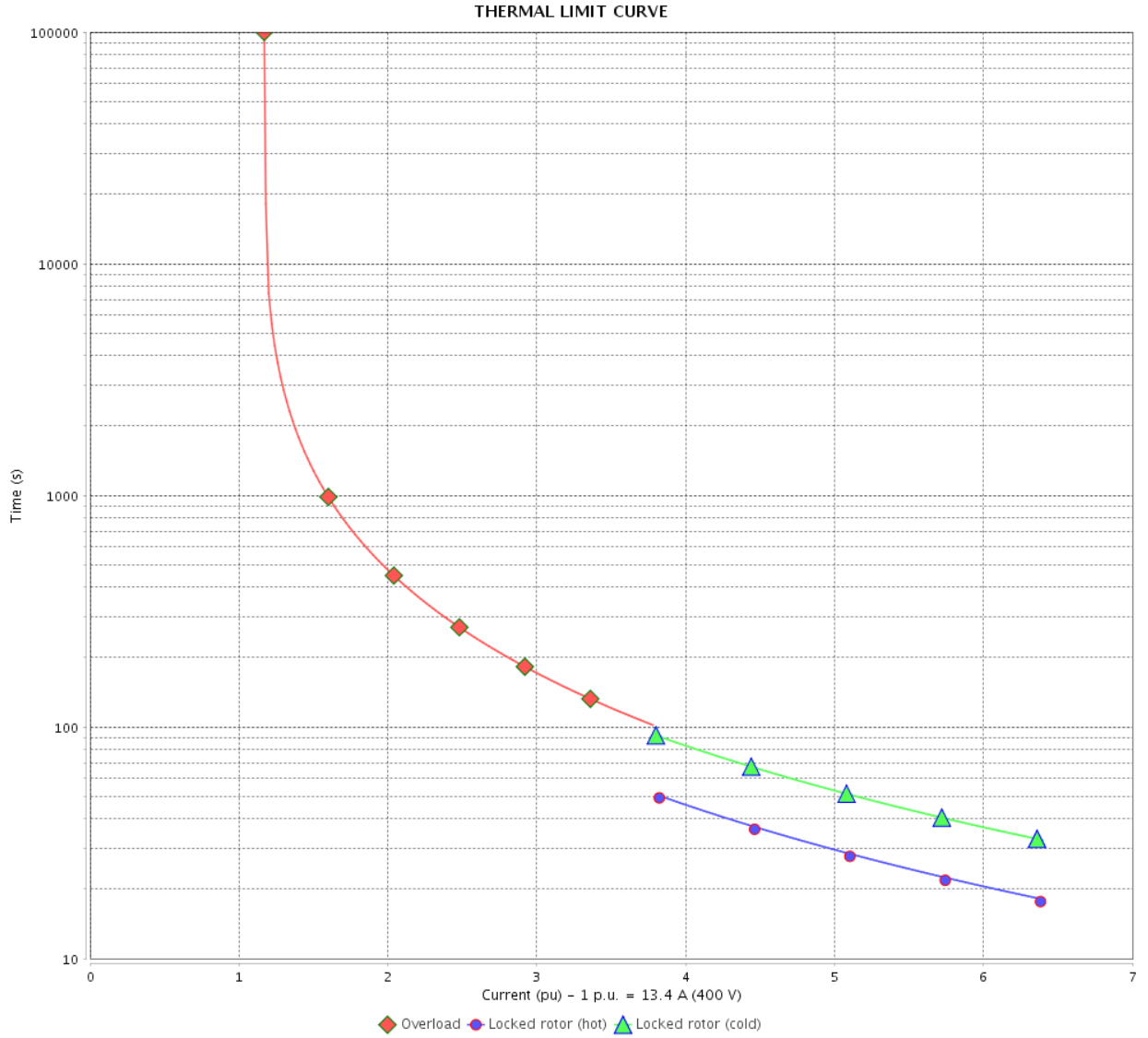

Rev.	Changes Summary	Performed	Checked	Date
Performed by		Page 27 / 36		Revision
Checked by				
Date				

THERMAL LIMIT CURVE



Three Phase Induction Motor - Squirrel Cage

Customer :

Product line : NEMA Premium Efficiency Three-Phase
Product code : 11441768
Catalog # : 01036ET3E215T-W22

Performance : 415 V 50 Hz 2P IE2

Rated current	: 13.1 A	Moment of inertia (J)	: 0.6362 sq.ft.lb
LRC	: 6.9	Duty cycle	: Cont.(S1)
Rated torque	: 18.1 ft.lb	Insulation class	: F
Locked rotor torque	: 220 %	Service factor	: 1.00
Breakdown torque	: 270 %	Temperature rise	: 105 K
Rated speed	: 2900 rpm	Design	: B

Heating constant

Cooling constant

Rev.	Changes Summary	Performed	Checked	Date
Performed by				
Checked by			Page	Revision
Date	12/04/2022		28 / 36	

THERMAL LIMIT CURVE

Three Phase Induction Motor - Squirrel Cage



Customer : _____

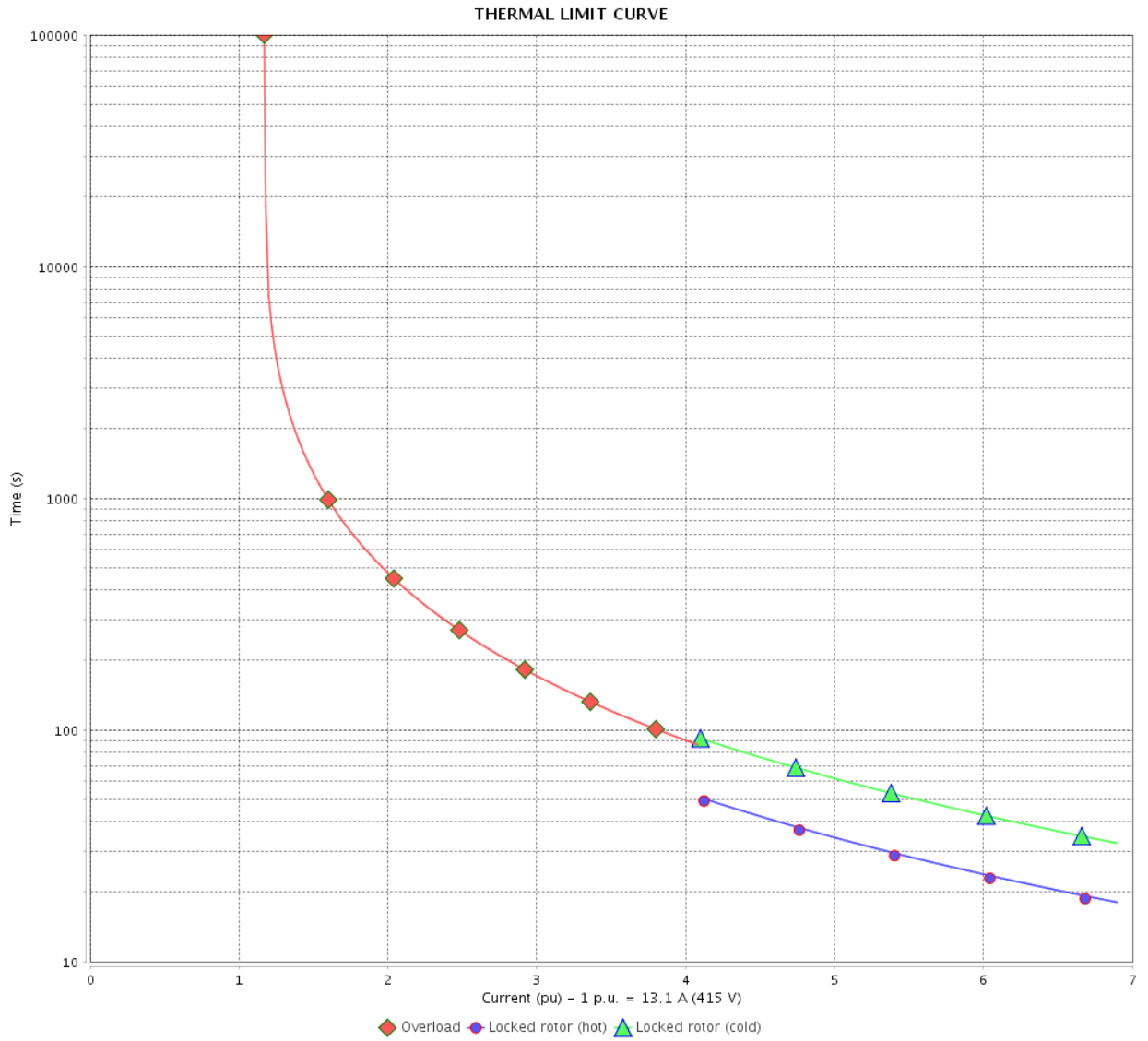

Rev.	Changes Summary	Performed	Checked	Date
Performed by		Page		Revision
Checked by		29 / 36		
Date	12/04/2022			

VFD OPERATION CURVE

Three Phase Induction Motor - Squirrel Cage



Customer :

Product line : NEMA Premium Efficiency Three-Phase

Product code : 11441768

Catalog # : 01036ET3E215T-W22

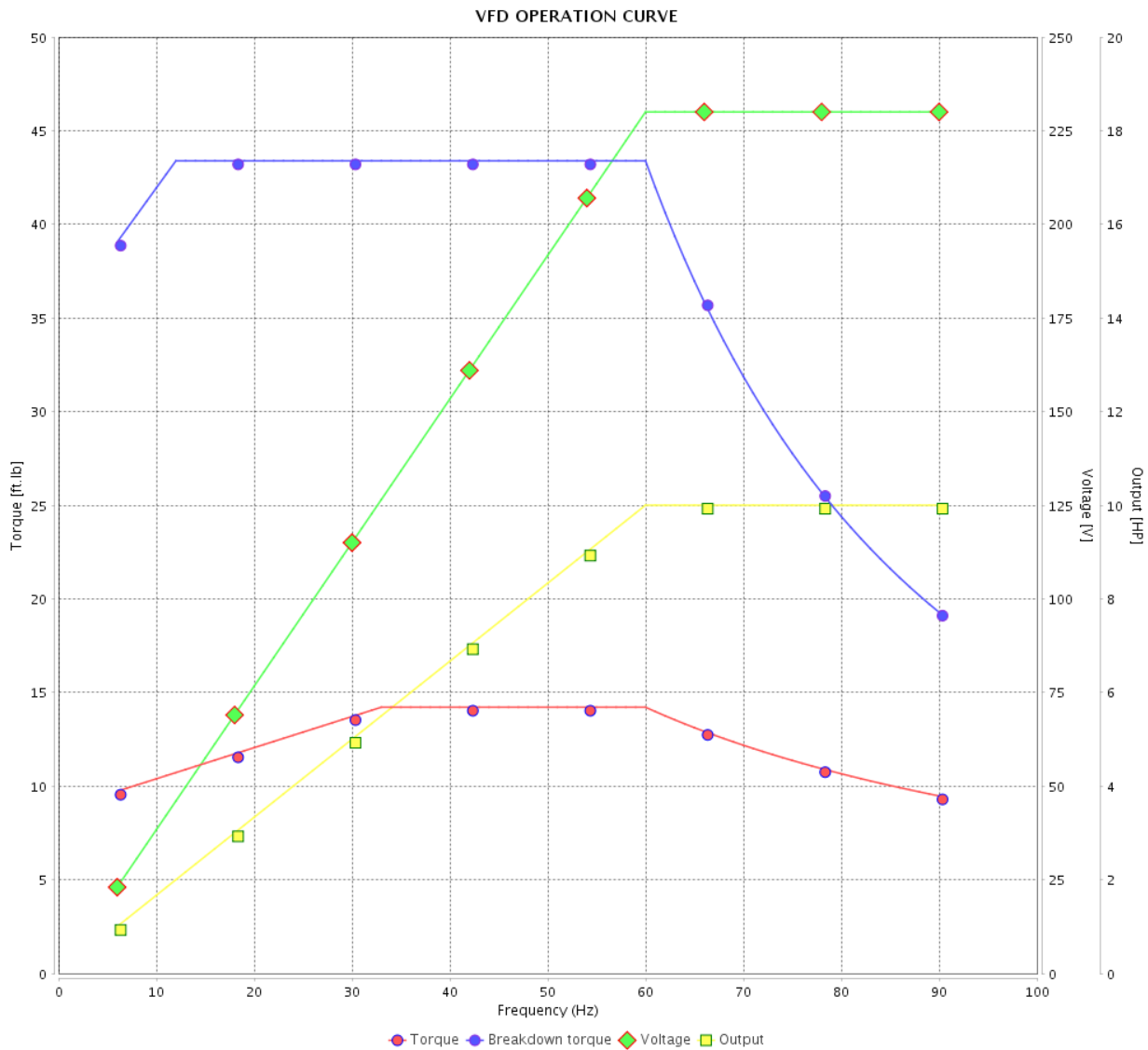

Performance : 230/460 V 60 Hz 2P

Rated current : 23.2/11.6 A
 LRC : 7.2
 Rated torque : 15.0 ft.lb
 Locked rotor torque : 220 %
 Breakdown torque : 290 %
 Rated speed : 3510 rpm

Moment of inertia (J) : 0.6362 sq.ft.lb
 Duty cycle : Cont.(S1)
 Insulation class : F
 Service factor : 1.25
 Temperature rise : 80 K
 Design : B

Rev.	Changes Summary	Performed	Checked	Date
Performed by			Page 30 / 36	Revision
Checked by				
Date	12/04/2022			

VFD OPERATION CURVE

Three Phase Induction Motor - Squirrel Cage



Customer : _____

Product line : NEMA Premium Efficiency Three-Phase

Product code : 11441768

Catalog # : 01036ET3E215T-W22

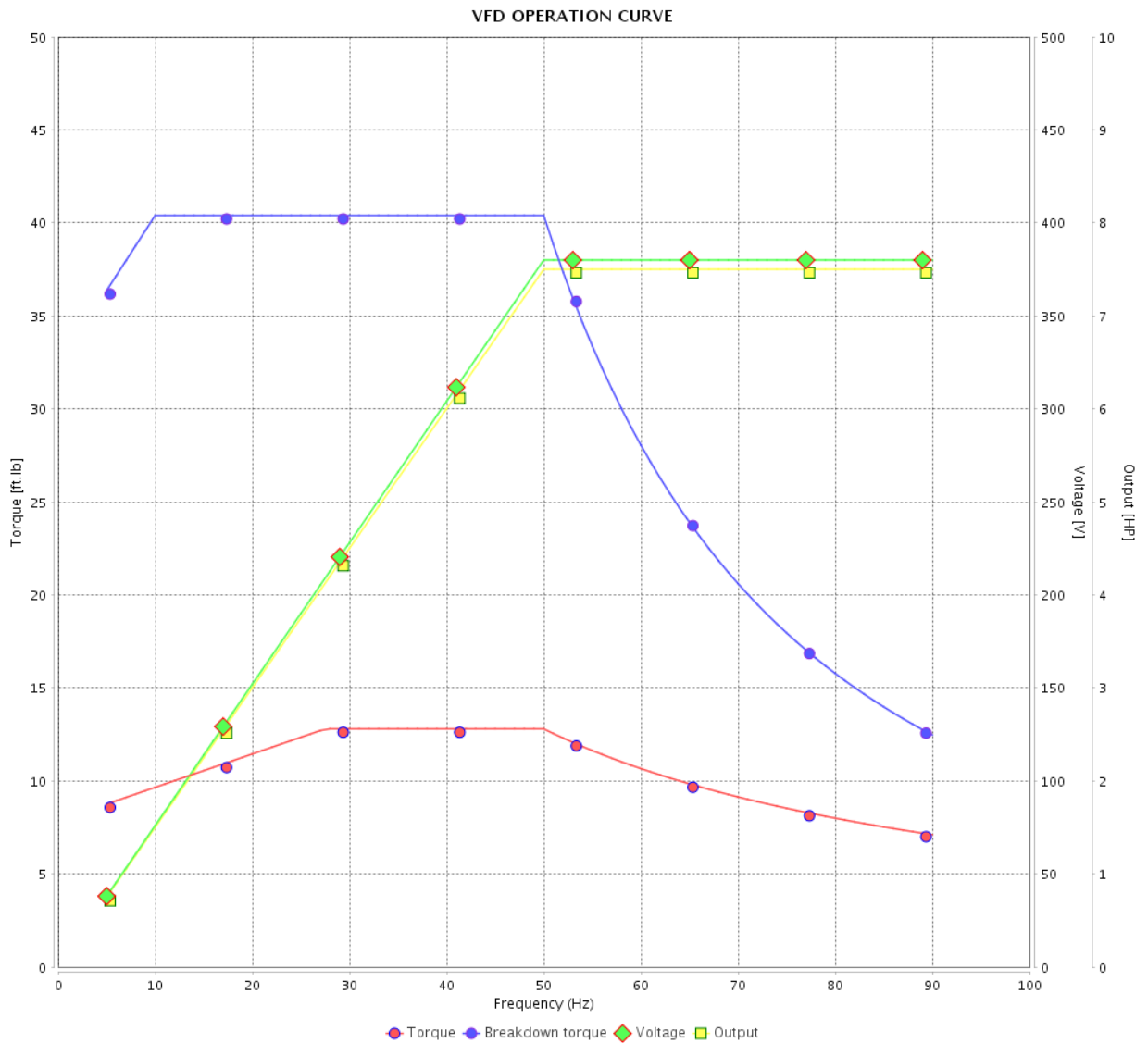

Performance : 380 V 50 Hz 2P IE3

Rated current : 10.4 A
 LRC : 7.4
 Rated torque : 13.5 ft.lb
 Locked rotor torque : 240 %
 Breakdown torque : 300 %
 Rated speed : 2925 rpm

Moment of inertia (J) : 0.6362 sq.ft.lb
 Duty cycle : Cont.(S1)
 Insulation class : F
 Service factor : 1.25
 Temperature rise : 80 K
 Design : B

Rev.	Changes Summary	Performed	Checked	Date
Performed by		Page		Revision
Checked by		31 / 36		
Date	12/04/2022			

VFD OPERATION CURVE

Three Phase Induction Motor - Squirrel Cage



Customer :

Product line : NEMA Premium Efficiency Three-Phase

Product code : 11441768

Catalog # : 01036ET3E215T-W22

VFD OPERATION CURVE

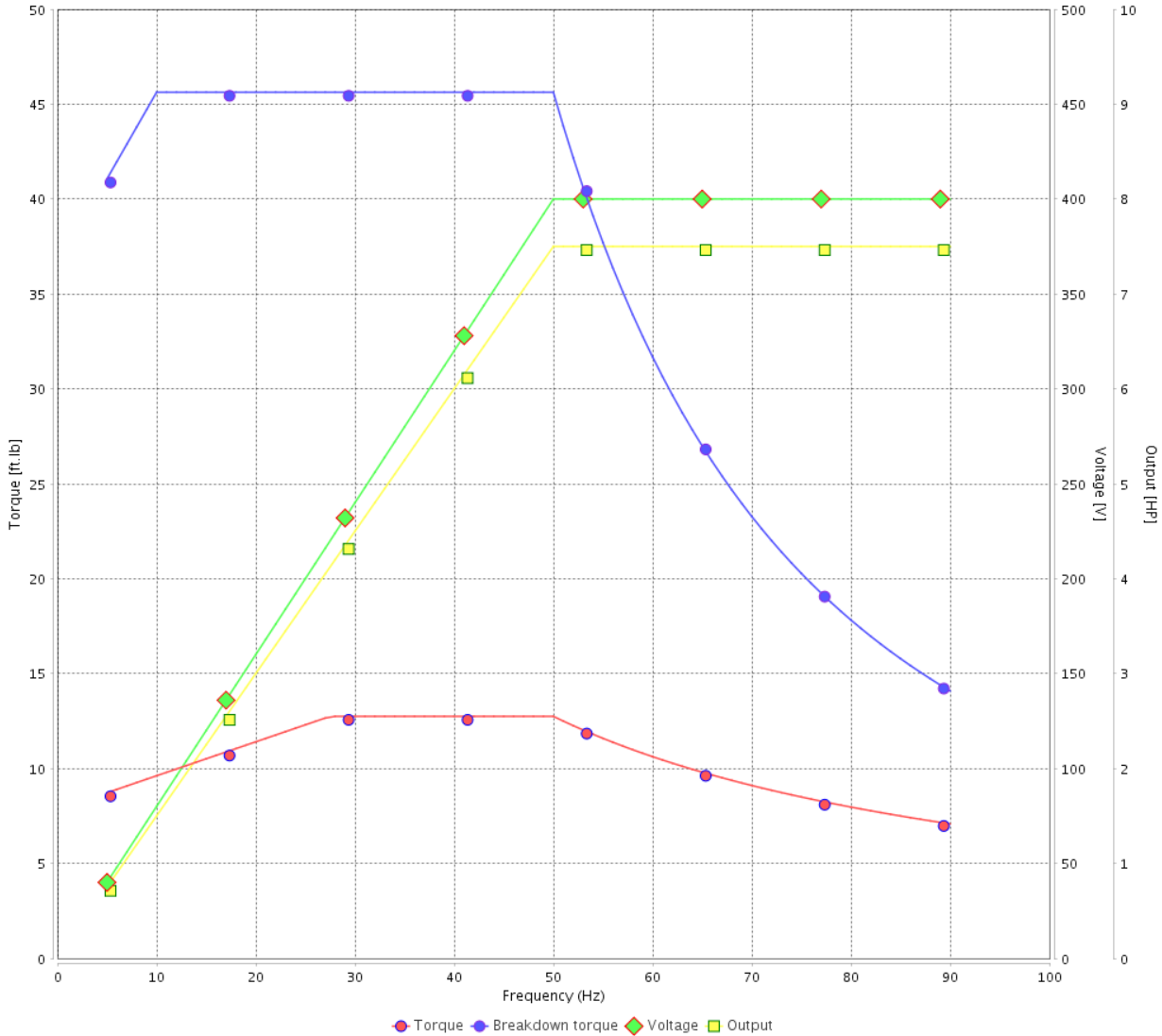

Performance : 400 V 50 Hz 2P IE3

Rated current : 10.1 A
 LRC : 8.4
 Rated torque : 13.4 ft.lb
 Locked rotor torque : 270 %
 Breakdown torque : 340 %
 Rated speed : 2935 rpm

Moment of inertia (J) : 0.6362 sq.ft.lb
 Duty cycle : Cont.(S1)
 Insulation class : F
 Service factor : 1.25
 Temperature rise : 80 K
 Design : B

Rev.	Changes Summary	Performed	Checked	Date
Performed by			Page 32 / 36	Revision
Checked by				
Date	12/04/2022			

VFD OPERATION CURVE

Three Phase Induction Motor - Squirrel Cage



Customer : _____

Product line : NEMA Premium Efficiency Three-Phase

Product code : 11441768

Catalog # : 01036ET3E215T-W22

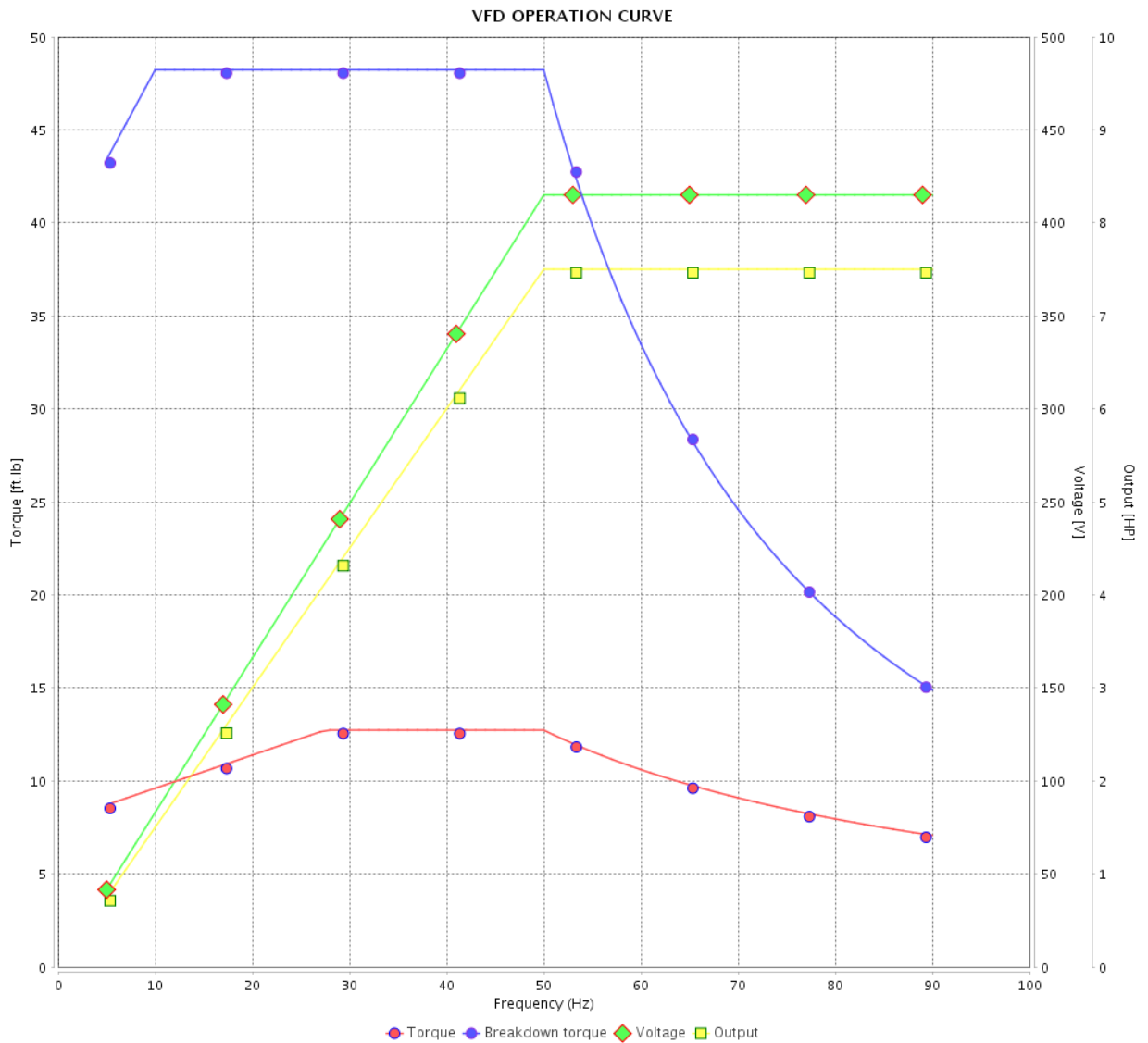

Performance : 415 V 50 Hz 2P IE3

Rated current : 9.91 A
 LRC : 9.1
 Rated torque : 13.4 ft.lb
 Locked rotor torque : 290 %
 Breakdown torque : 360 %
 Rated speed : 2940 rpm

Moment of inertia (J) : 0.6362 sq.ft.lb
 Duty cycle : Cont.(S1)
 Insulation class : F
 Service factor : 1.25
 Temperature rise : 80 K
 Design : B

Rev.	Changes Summary	Performed	Checked	Date
Performed by			Page	Revision
Checked by				
Date				
			33 / 36	

VFD OPERATION CURVE

Three Phase Induction Motor - Squirrel Cage



Customer :

Product line : NEMA Premium Efficiency Three-Phase

Product code : 11441768

Catalog # : 01036ET3E215T-W22

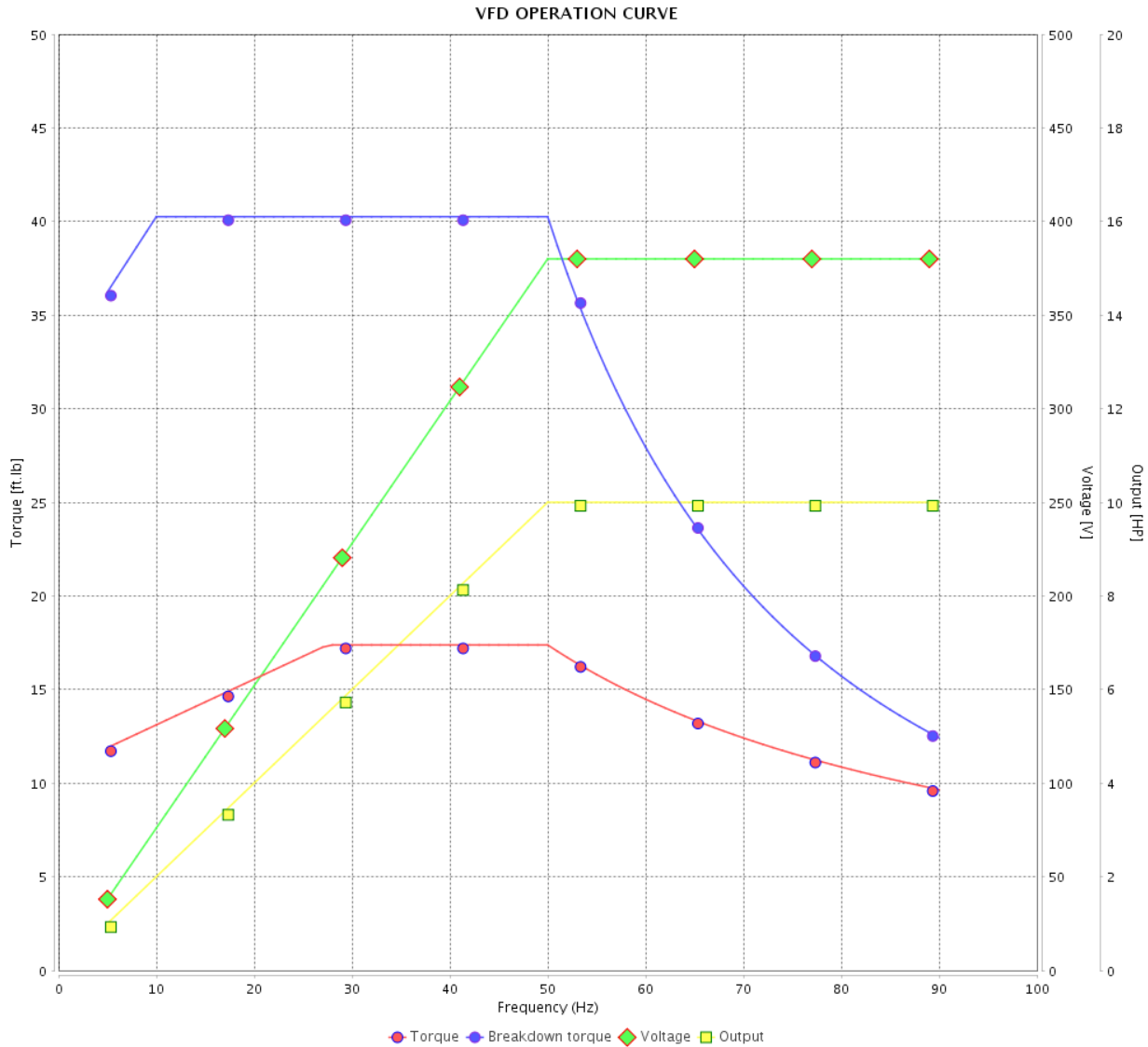

Performance : 380 V 50 Hz 2P IE2

Rated current : 14.1 A
 LRC : 5.6
 Rated torque : 18.3 ft.lb
 Locked rotor torque : 170 %
 Breakdown torque : 220 %
 Rated speed : 2870 rpm

Moment of inertia (J) : 0.6362 sq.ft.lb
 Duty cycle : Cont.(S1)
 Insulation class : F
 Service factor : 1.00
 Temperature rise : 105 K
 Design : B

Rev.	Changes Summary	Performed	Checked	Date
Performed by			Page 34 / 36	Revision
Checked by				
Date	12/04/2022			

VFD OPERATION CURVE

Three Phase Induction Motor - Squirrel Cage



Customer :

Product line : NEMA Premium Efficiency Three-Phase

Product code : 11441768

Catalog # : 01036ET3E215T-W22

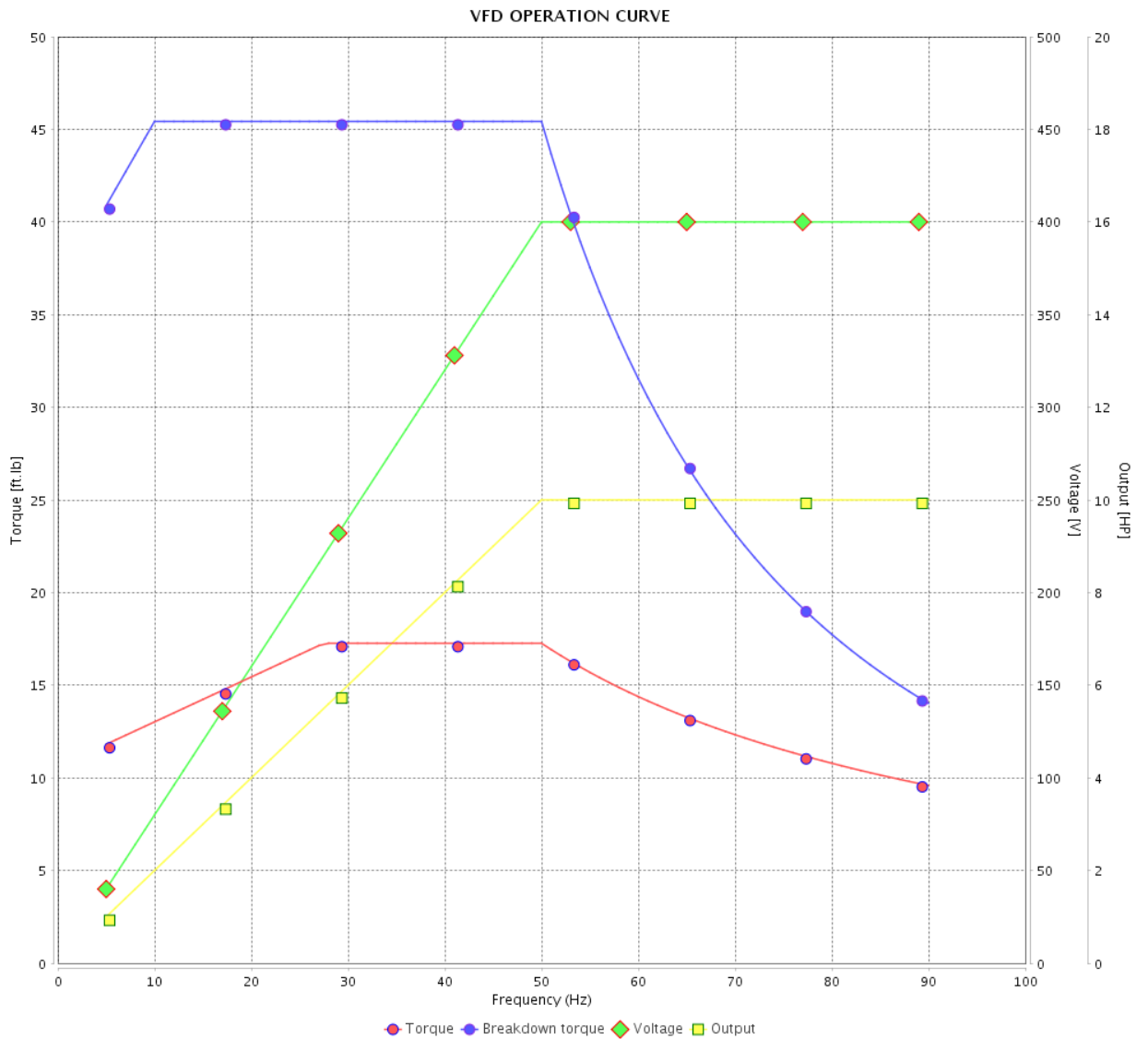

Performance : 400 V 50 Hz 2P IE2

Rated current : 13.4 A
 LRC : 6.4
 Rated torque : 18.2 ft.lb
 Locked rotor torque : 200 %
 Breakdown torque : 250 %
 Rated speed : 2890 rpm

Moment of inertia (J) : 0.6362 sq.ft.lb
 Duty cycle : Cont.(S1)
 Insulation class : F
 Service factor : 1.00
 Temperature rise : 105 K
 Design : B

Rev.	Changes Summary	Performed	Checked	Date
Performed by			Page 35 / 36	Revision
Checked by				
Date	12/04/2022			

VFD OPERATION CURVE

Three Phase Induction Motor - Squirrel Cage



Customer :

Product line : NEMA Premium Efficiency Three-Phase

Product code : 11441768

Catalog # : 01036ET3E215T-W22

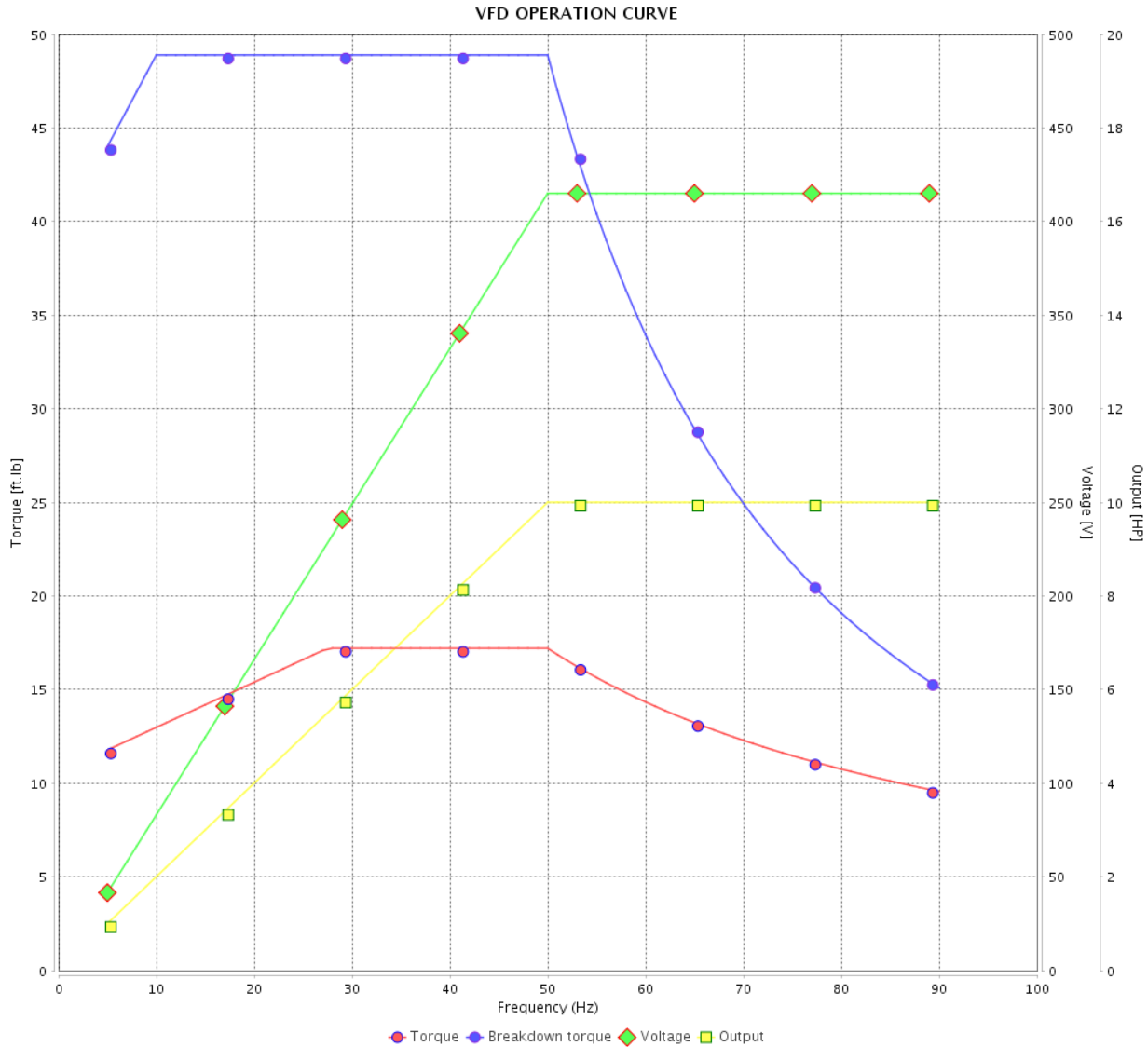

Performance : 415 V 50 Hz 2P IE2

Rated current : 13.1 A
 LRC : 6.9
 Rated torque : 18.1 ft.lb
 Locked rotor torque : 220 %
 Breakdown torque : 270 %
 Rated speed : 2900 rpm

Moment of inertia (J) : 0.6362 sq.ft.lb
 Duty cycle : Cont.(S1)
 Insulation class : F
 Service factor : 1.00
 Temperature rise : 105 K
 Design : B

Rev.	Changes Summary	Performed	Checked	Date
Performed by			Page	Revision
Checked by				
Date				
			36 / 36	

1 2 3 4 5 6

A

B

C

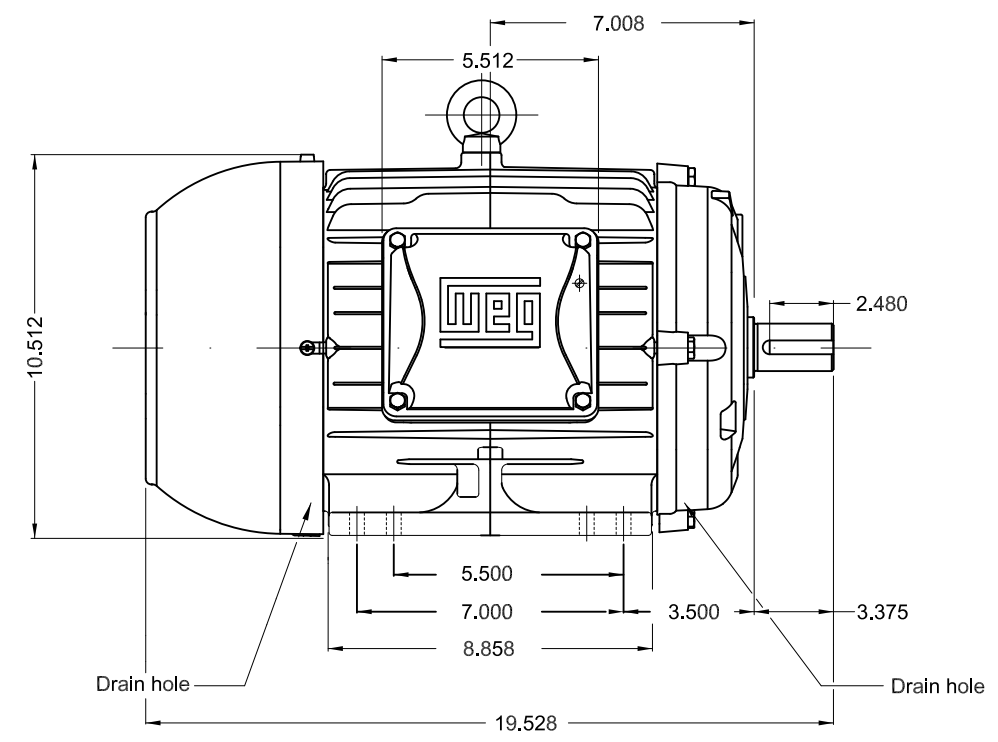
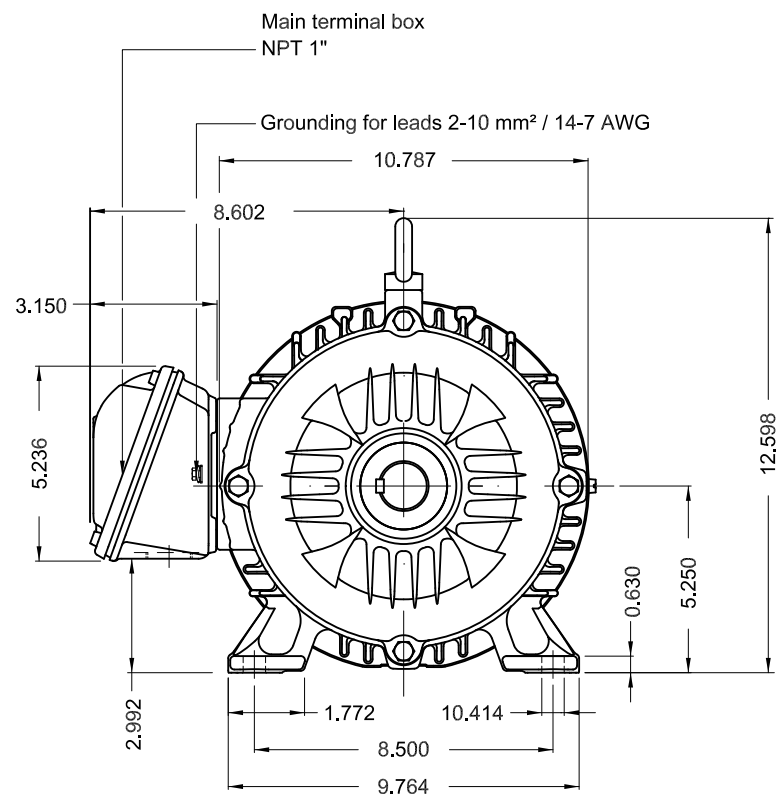

D

E

Color RAL 5009
 Painting plan 207A
 Mounting B3R(D)

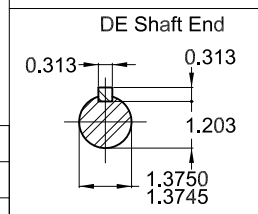

10 HP 02 Poles 60 Hz A

ECM	LOC	SUMMARY OF MODIFICATIONS	EXECUTED	CHECKED	RELEASED	DATE	VER
EXECUTED	PIRWBUSER	THREE PH. MOTOR W22 PREM. EFF.					
CHECKED		FRAME 213/5T IP55 TEFC					
RELEASED							
REL DT.	WMO	Jaragua do Sul	Product Engineering	SHEET	1 / 1		

PREVIEW
 WDD



MADE IN BRAZIL
11441768



MODEL 01036ET3E215T-W22

Inverter Duty Motor
Severe Duty



For use on 60Hz
Class I, Div 2, Gr A, B, C and D - T3
Class I, Zone 2, IIC - T3
Class II, Div 2, Gr F and G - T4
For use on PWM: Gr. A, B, C, D and F,
VT 1000:1, CT 20:1, 1.00SF - T3A



FOR SAFE AREA
Mod. TE1BFOXON
CC029A

PH3 60Hz Fr. 213/5T 1000m.a.s.l. IP55 TEFC 161lb

V 230/460

A 23.2/11.6

HP 10

kW 7.5

SF 1.25

SFA 29.0/14.5

RPM 3530

PF 0.90

AMB 40°C

INS cl. F DT80K

NEMA NOM EFF 90.2%

DUTY CONT.

DES B Code H

USABLE @208V 25.7A SF 1.15 SFA 29.6

10HP 7.5kW 50Hz 380V 14.1A 2900RPM SF 1.00 EFF 88.5% (IE2)

