

# DATA SHEET



## Three Phase Induction Motor - Squirrel Cage

Customer :								
Product line	: NEMA Premium Efficiency Three-Phase	Product code :	12598765					
		Catalog # :	01512ET3E284JM-W22					
Frame	: 284/6JM	Cooling method	: IC411 - TEFC					
Insulation class	: F	Mounting	: F-1					
Duty cycle	: Cont.(S1)	Rotation <sup>1</sup>	: Both (CW and CCW)					
Ambient temperature	: -20°C to +40°C	Starting method	: Direct On Line					
Altitude	: 1000 m.a.s.l.	Approx. weight <sup>2</sup>	: 422 lb					
Protection degree	: IP55	Moment of inertia (J)	: 7.85 sq.ft.lb					
Design	: B							
Output [HP]	15	10	10	10	15	15	15	
Poles	6	6	6	6	6	6	6	
Frequency [Hz]	60	50	50	50	50	50	50	
Rated voltage [V]	230/460	380	400	415	380	400	415	
Rated current [A]	35.8/17.9	15.5	15.1	14.9	22.0	20.9	20.2	
L. R. Amperes [A]	229/115	112	119	124	103	111	115	
LRC [A]	6.4x(Code G)	7.2x(Code J)	7.9x(Code K)	8.3x(Code K)	4.7x(Code E)	5.3x(Code F)	5.7x(Code F)	
No load current [A]	14.0/7.00	7.00	7.40	7.70	7.00	7.40	7.70	
Rated speed [RPM]	1175	985	985	985	965	970	975	
Slip [%]	2.08	1.50	1.50	1.50	3.50	3.00	2.50	
Rated torque [ft.lb]	67.0	53.3	53.3	53.3	81.6	81.2	80.8	
Locked rotor torque [%]	229	270	300	330	170	200	220	
Breakdown torque [%]	260	300	340	360	210	229	250	
Service factor	1.25	1.25	1.25	1.25	1.00	1.15	1.15	
Temperature rise	80 K	80 K	80 K	80 K	80 K	80 K	80 K	
Locked rotor time	36s (cold) 20s (hot)	61s (cold) 34s (hot)	54s (cold) 30s (hot)	52s (cold) 29s (hot)	27s (cold) 15s (hot)	27s (cold) 15s (hot)	27s (cold) 15s (hot)	
Noise level <sup>2</sup>	59.0 dB(A)	56.0 dB(A)	56.0 dB(A)	56.0 dB(A)	56.0 dB(A)	56.0 dB(A)	56.0 dB(A)	
Efficiency (%)	25%	90.8	88.9	89.0	89.0	92.4	90.6	90.7
	50%	91.0	89.0	89.1	89.1	91.0	90.2	90.2
	75%	91.7	89.4	89.5	89.5	90.2	90.2	91.0
	100%	91.7	89.4	89.5	89.5	88.5	89.5	90.2
Power Factor	25%	0.44	0.39	0.36	0.34	0.50	0.47	0.45
	50%	0.69	0.64	0.61	0.58	0.75	0.72	0.70
	75%	0.80	0.76	0.73	0.71	0.84	0.82	0.81
	100%	0.84	0.82	0.80	0.78	0.86	0.85	0.84
Bearing type	: Drive end : 6311 C3	Non drive end : 6211 C3	Foundation loads					
Sealing	: V'Ring	V'Ring	Max. traction	: 670 lb				
Lubrication interval	: 20000 h	20000 h	Max. compression	: 1092 lb				
Lubricant amount	: 18 g	11 g						
Lubricant type	: Mobil Polyrex EM							
Notes								
USABLE @208V 39.6A SF 1.15 SFA 45.5A								
This revision replaces and cancel the previous one, which must be eliminated. (1) Looking the motor from the shaft end. (2) Measured at 1m and with tolerance of +3dB(A). (3) Approximate weight subject to changes after manufacturing process. (4) At 100% of full load.				These are average values based on tests with sinusoidal power supply, subject to the tolerances stipulated in NEMA MG-1.				
Rev.	Changes Summary			Performed	Checked	Date		
Performed by								
Checked by					Page	Revision		
Date	13/04/2022				1 / 36			

# TORQUE AND CURRENT VS SPEED CURVE

Three Phase Induction Motor - Squirrel Cage



Customer :

Product line : NEMA Premium Efficiency Three-Phase

Product code : 12598765

Catalog # : 01512ET3E284JM-W22

TORQUE AND CURRENT VS SPEED CURVE

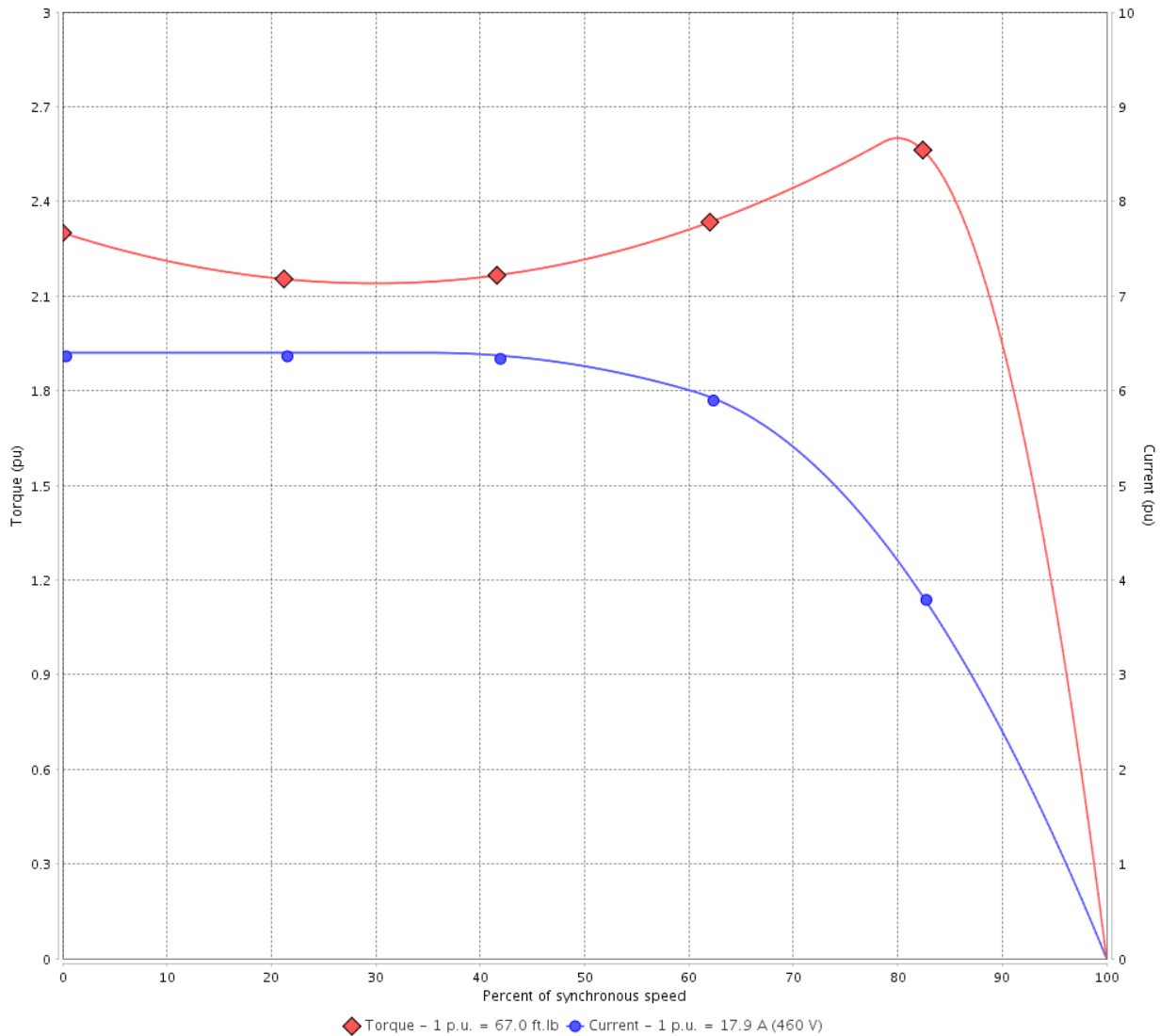

Performance : 230/460 V 60 Hz 6P

Rated current	: 35.8/17.9 A	Moment of inertia (J)	: 7.85 sq.ft.lb
LRC	: 6.4	Duty cycle	: Cont.(S1)
Rated torque	: 67.0 ft.lb	Insulation class	: F
Locked rotor torque	: 229 %	Service factor	: 1.25
Breakdown torque	: 260 %	Temperature rise	: 80 K
Rated speed	: 1175 rpm	Design	: B

Locked rotor time : 36s (cold) 20s (hot)

Rev.	Changes Summary	Performed	Checked	Date
Performed by			Page 2 / 36	Revision
Checked by				
Date	13/04/2022			

# TORQUE AND CURRENT VS SPEED CURVE



## Three Phase Induction Motor - Squirrel Cage

Customer :

Product line : NEMA Premium Efficiency Three-Phase

Product code : 12598765

Catalog # : 01512ET3E284JM-W22

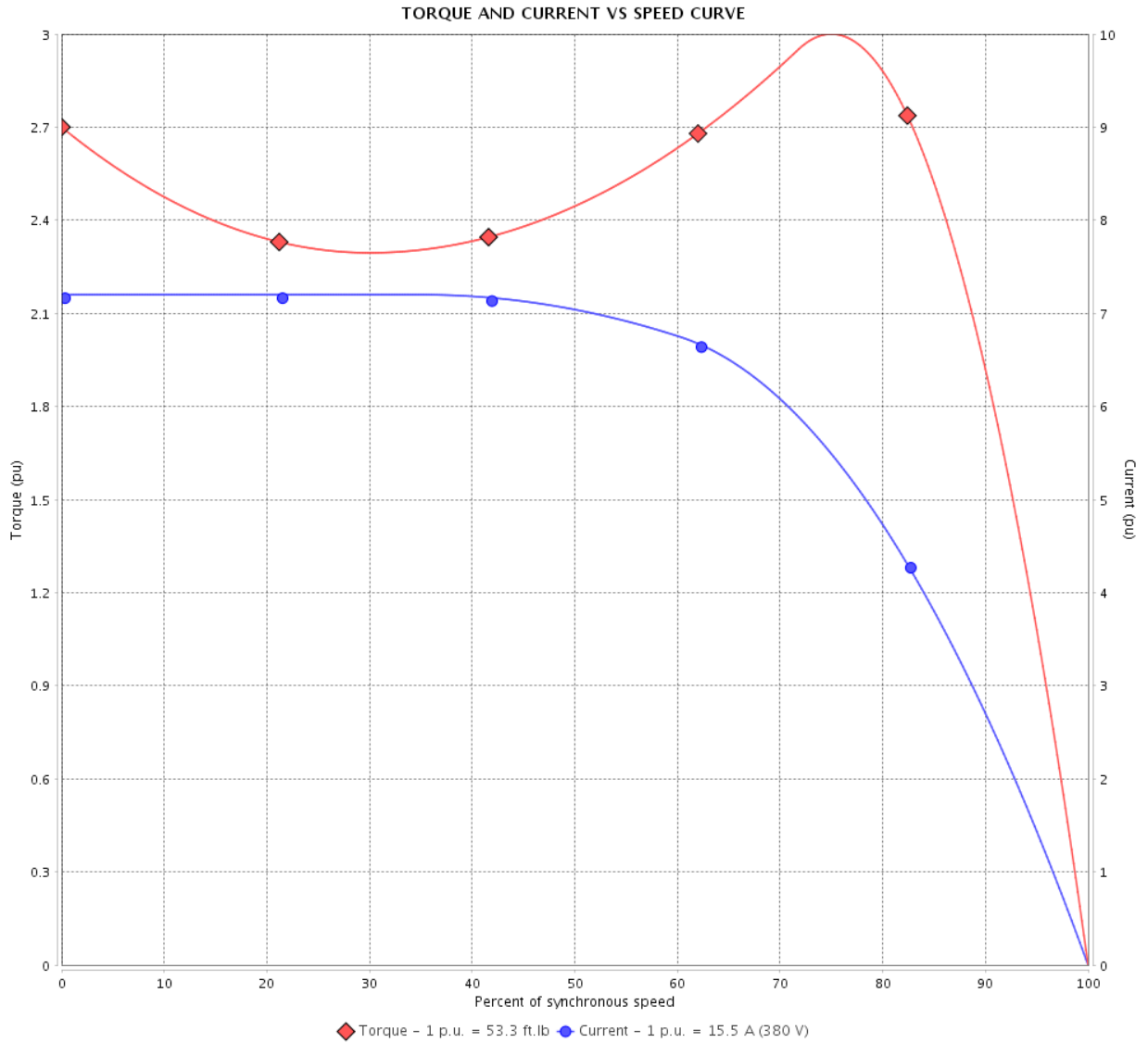

Performance : 380 V 50 Hz 6P IE3

Rated current	: 15.5 A	Moment of inertia (J)	: 7.85 sq.ft.lb
LRC	: 7.2	Duty cycle	: Cont.(S1)
Rated torque	: 53.3 ft.lb	Insulation class	: F
Locked rotor torque	: 270 %	Service factor	: 1.25
Breakdown torque	: 300 %	Temperature rise	: 80 K
Rated speed	: 985 rpm	Design	: B

Locked rotor time : 61s (cold) 34s (hot)

Rev.	Changes Summary	Performed	Checked	Date
Performed by		Page		Revision
Checked by		3 / 36		
Date	13/04/2022			

# TORQUE AND CURRENT VS SPEED CURVE

Three Phase Induction Motor - Squirrel Cage



Customer :

Product line : NEMA Premium Efficiency Three-Phase

Product code : 12598765

Catalog # : 01512ET3E284JM-W22

TORQUE AND CURRENT VS SPEED CURVE

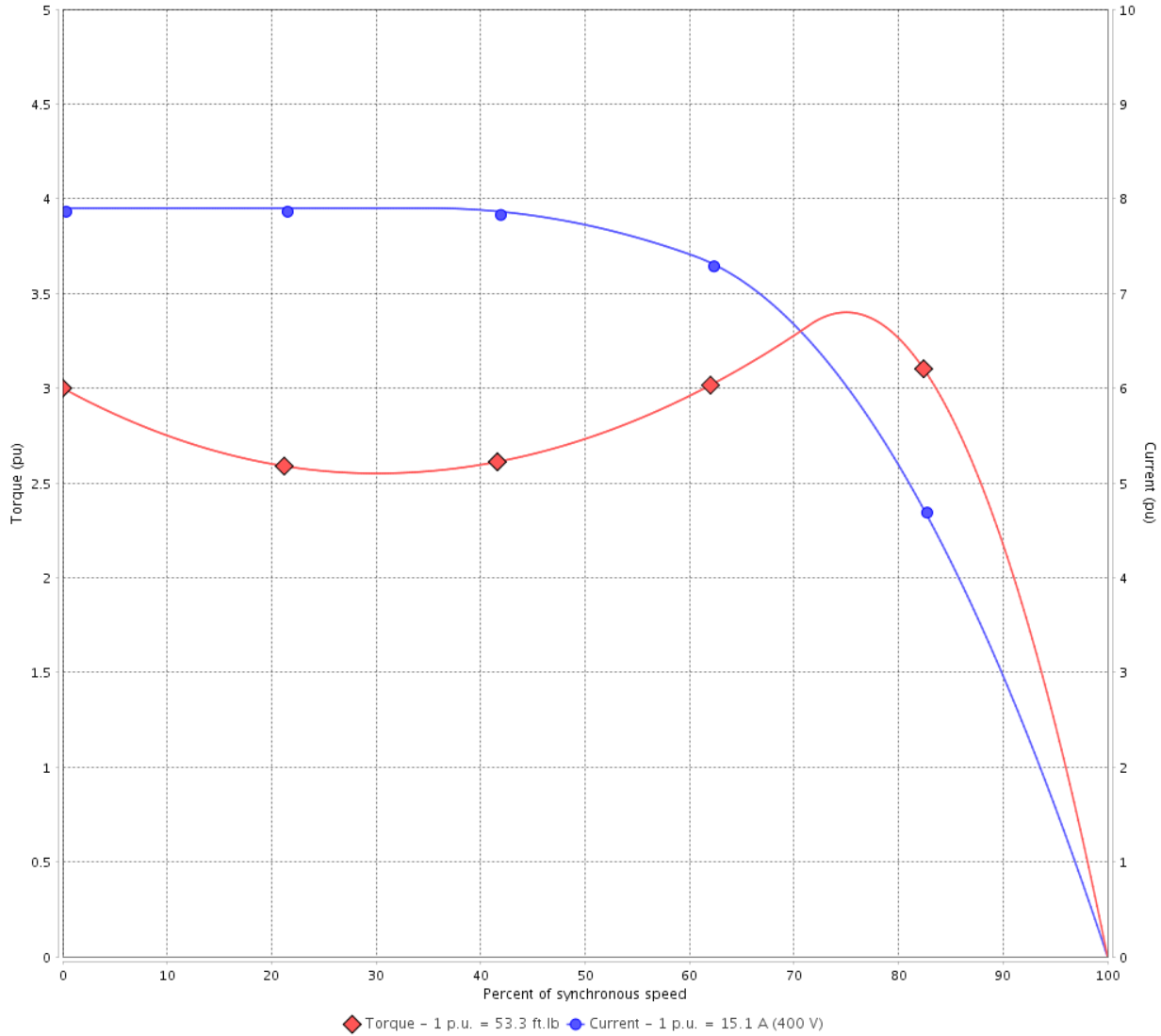

Performance : 400 V 50 Hz 6P IE3

Rated current	: 15.1 A	Moment of inertia (J)	: 7.85 sq.ft.lb
LRC	: 7.9	Duty cycle	: Cont.(S1)
Rated torque	: 53.3 ft.lb	Insulation class	: F
Locked rotor torque	: 300 %	Service factor	: 1.25
Breakdown torque	: 340 %	Temperature rise	: 80 K
Rated speed	: 985 rpm	Design	: B

Locked rotor time : 54s (cold) 30s (hot)

Rev.	Changes Summary	Performed	Checked	Date
Performed by			Page 4 / 36	Revision
Checked by				
Date	13/04/2022			

# TORQUE AND CURRENT VS SPEED CURVE



## Three Phase Induction Motor - Squirrel Cage

Customer :

Product line : NEMA Premium Efficiency Three-Phase

Product code : 12598765

Catalog # : 01512ET3E284JM-W22

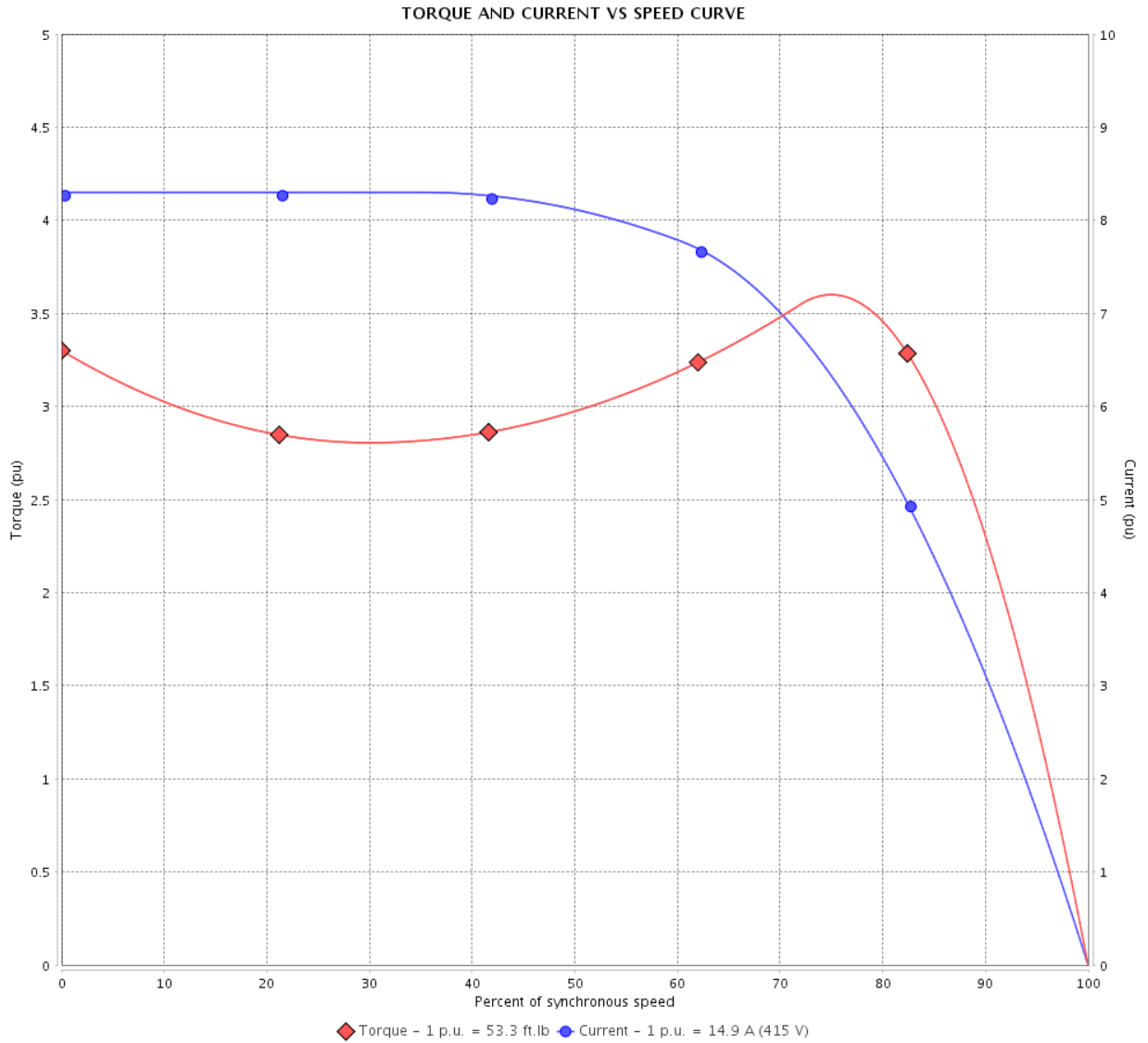

Performance : 415 V 50 Hz 6P IE3

Rated current	: 14.9 A	Moment of inertia (J)	: 7.85 sq.ft.lb
LRC	: 8.3	Duty cycle	: Cont.(S1)
Rated torque	: 53.3 ft.lb	Insulation class	: F
Locked rotor torque	: 330 %	Service factor	: 1.25
Breakdown torque	: 360 %	Temperature rise	: 80 K
Rated speed	: 985 rpm	Design	: B

Locked rotor time : 52s (cold) 29s (hot)

Rev.	Changes Summary	Performed	Checked	Date
Performed by			Page 5 / 36	Revision
Checked by				
Date	13/04/2022			

# TORQUE AND CURRENT VS SPEED CURVE

Three Phase Induction Motor - Squirrel Cage



Customer :

Product line : NEMA Premium Efficiency Three-Phase

Product code : 12598765

Catalog # : 01512ET3E284JM-W22

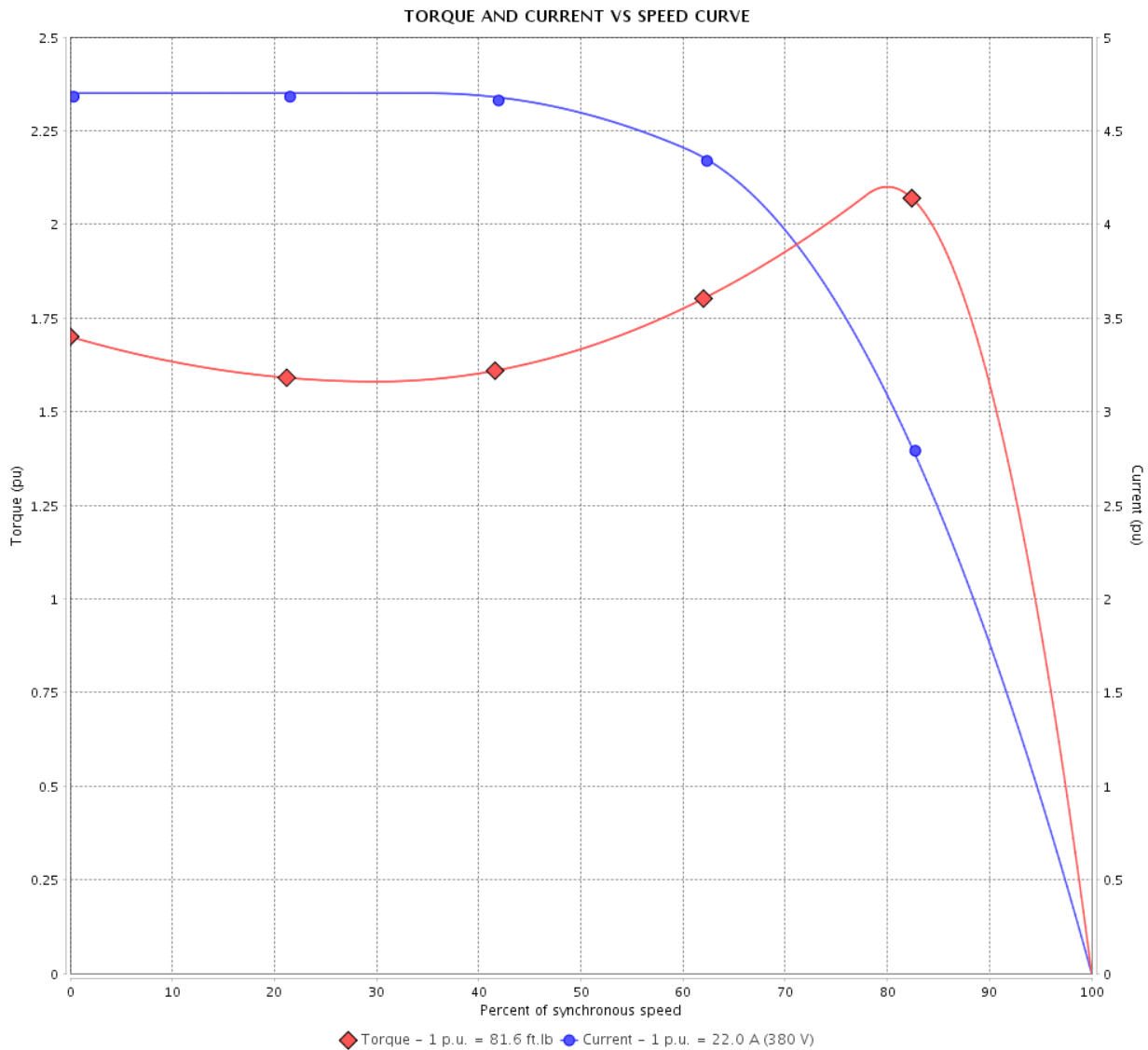

Performance : 380 V 50 Hz 6P IE1

Rated current	: 22.0 A	Moment of inertia (J)	: 7.85 sq.ft.lb
LRC	: 4.7	Duty cycle	: Cont.(S1)
Rated torque	: 81.6 ft.lb	Insulation class	: F
Locked rotor torque	: 170 %	Service factor	: 1.00
Breakdown torque	: 210 %	Temperature rise	: 80 K
Rated speed	: 965 rpm	Design	: B

Locked rotor time : 27s (cold) 15s (hot)

Rev.	Changes Summary	Performed	Checked	Date
Performed by			Page 6 / 36	Revision
Checked by				
Date	13/04/2022			

# TORQUE AND CURRENT VS SPEED CURVE



## Three Phase Induction Motor - Squirrel Cage

Customer :

Product line : NEMA Premium Efficiency Three-Phase

Product code : 12598765

Catalog # : 01512ET3E284JM-W22

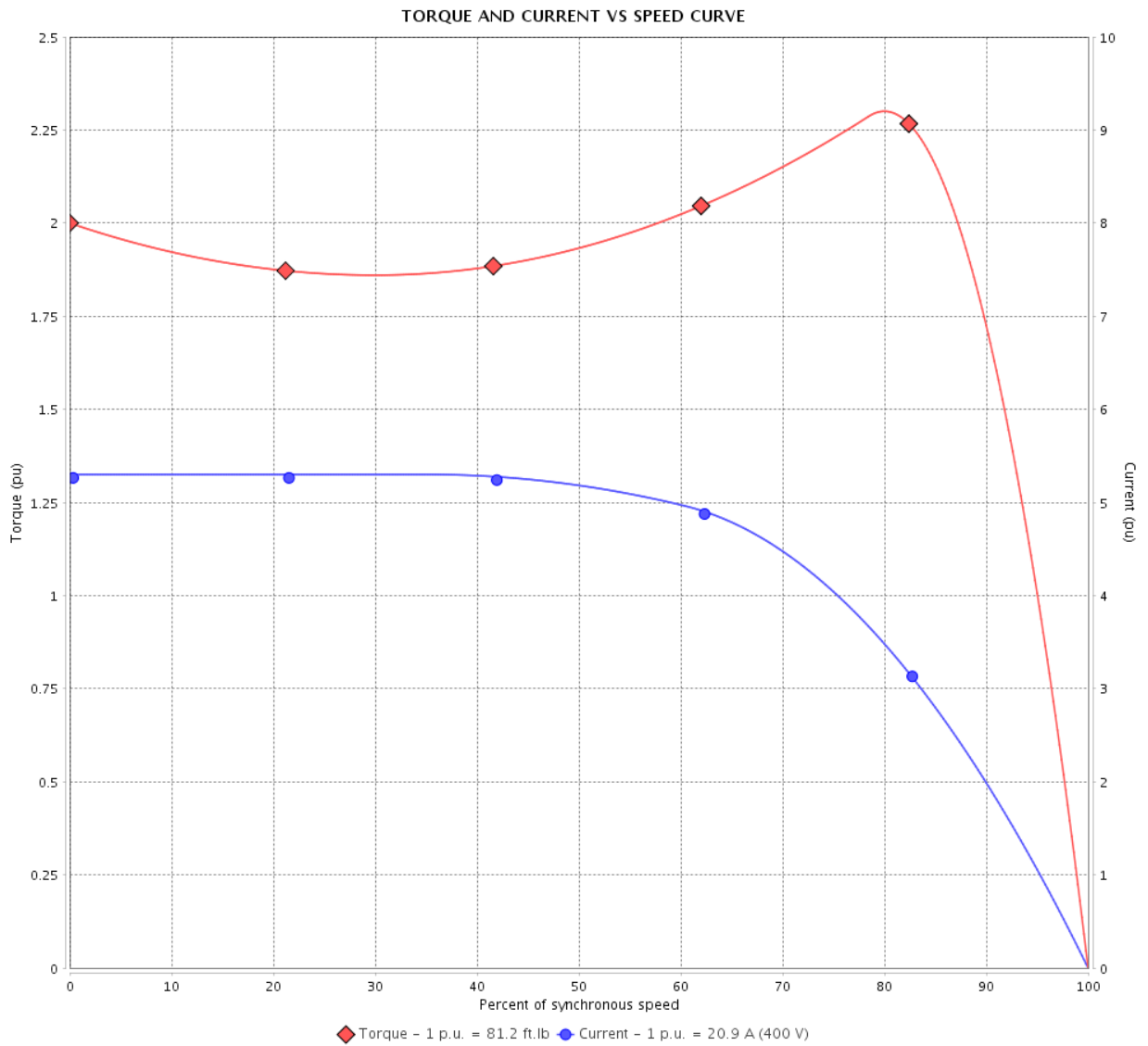

Performance : 400 V 50 Hz 6P IE2

Rated current	: 20.9 A	Moment of inertia (J)	: 7.85 sq.ft.lb
LRC	: 5.3	Duty cycle	: Cont.(S1)
Rated torque	: 81.2 ft.lb	Insulation class	: F
Locked rotor torque	: 200 %	Service factor	: 1.15
Breakdown torque	: 229 %	Temperature rise	: 80 K
Rated speed	: 970 rpm	Design	: B

Locked rotor time : 27s (cold) 15s (hot)

Rev.	Changes Summary	Performed	Checked	Date
Performed by			Page 7 / 36	Revision
Checked by				
Date	13/04/2022			

# TORQUE AND CURRENT VS SPEED CURVE

## Three Phase Induction Motor - Squirrel Cage



Customer :

Product line : NEMA Premium Efficiency Three-Phase

Product code : 12598765

Catalog # : 01512ET3E284JM-W22

TORQUE AND CURRENT VS SPEED CURVE

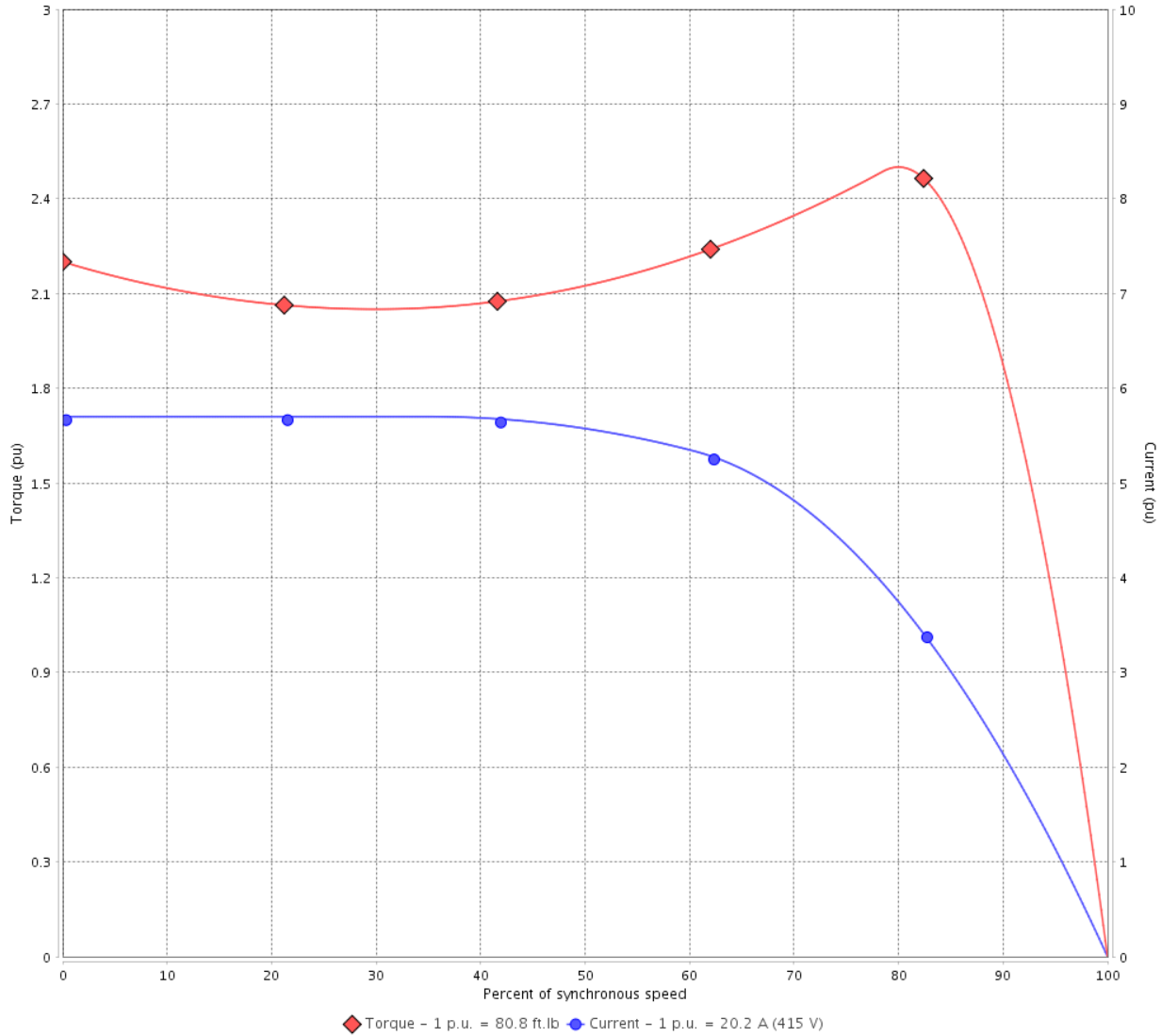

Performance : 415 V 50 Hz 6P IE2

Rated current	: 20.2 A	Moment of inertia (J)	: 7.85 sq.ft.lb
LRC	: 5.7	Duty cycle	: Cont.(S1)
Rated torque	: 80.8 ft.lb	Insulation class	: F
Locked rotor torque	: 220 %	Service factor	: 1.15
Breakdown torque	: 250 %	Temperature rise	: 80 K
Rated speed	: 975 rpm	Design	: B

Locked rotor time : 27s (cold) 15s (hot)

Rev.	Changes Summary	Performed	Checked	Date
Performed by			Page 8 / 36	Revision
Checked by				
Date	13/04/2022			



# LOAD PERFORMANCE CURVE

## Three Phase Induction Motor - Squirrel Cage



Customer :

Product line : NEMA Premium Efficiency Three-Phase

Product code : 12598765

Catalog # : 01512ET3E284JM-W22

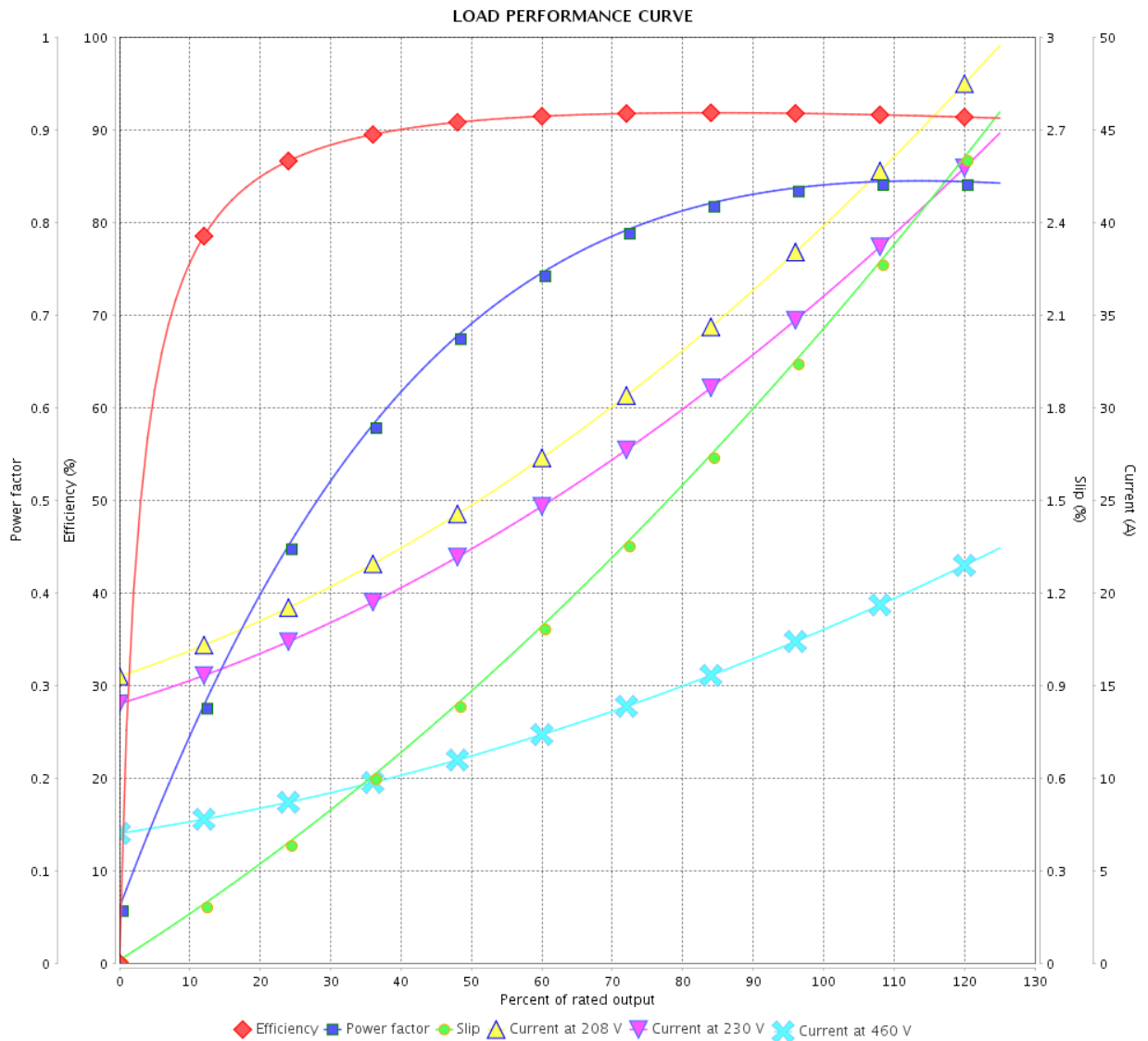

Performance : 230/460 V 60 Hz 6P

Rated current : 35.8/17.9 A  
 LRC : 6.4  
 Rated torque : 67.0 ft.lb  
 Locked rotor torque : 229 %  
 Breakdown torque : 260 %  
 Rated speed : 1175 rpm

Moment of inertia (J) : 7.85 sq.ft.lb  
 Duty cycle : Cont.(S1)  
 Insulation class : F  
 Service factor : 1.25  
 Temperature rise : 80 K  
 Design : B

Rev.	Changes Summary	Performed	Checked	Date
Performed by			Page	Revision
Checked by				
Date				

# LOAD PERFORMANCE CURVE

Three Phase Induction Motor - Squirrel Cage



Customer :

Product line : NEMA Premium Efficiency Three-Phase

Product code : 12598765

Catalog # : 01512ET3E284JM-W22

LOAD PERFORMANCE CURVE

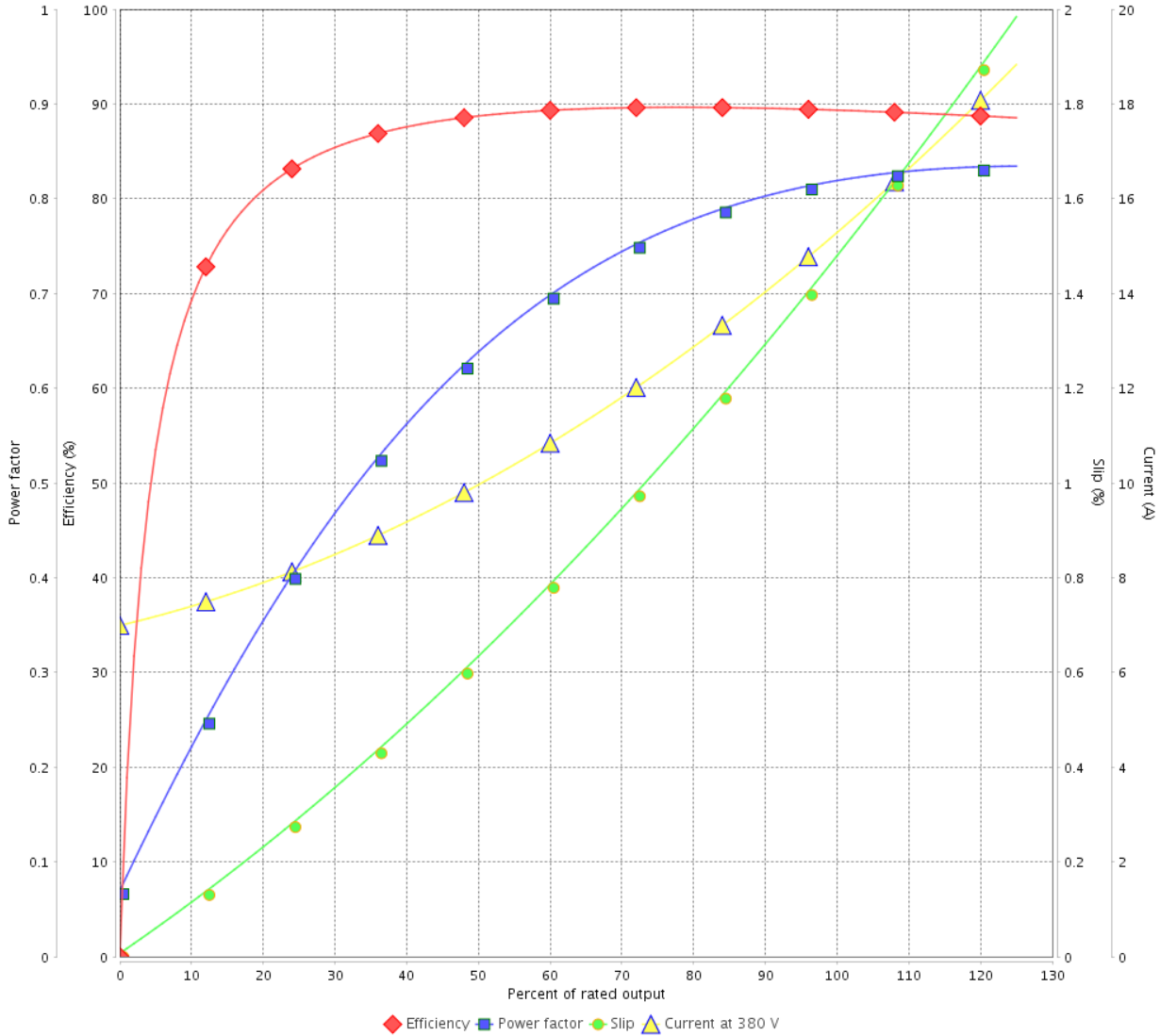

Performance : 380 V 50 Hz 6P IE3

Rated current : 15.5 A  
 LRC : 7.2  
 Rated torque : 53.3 ft.lb  
 Locked rotor torque : 270 %  
 Breakdown torque : 300 %  
 Rated speed : 985 rpm

Moment of inertia (J) : 7.85 sq.ft.lb  
 Duty cycle : Cont.(S1)  
 Insulation class : F  
 Service factor : 1.25  
 Temperature rise : 80 K  
 Design : B

Rev.	Changes Summary	Performed	Checked	Date
Performed by		Page		Revision
Checked by		10 / 36		
Date	13/04/2022			

# LOAD PERFORMANCE CURVE

## Three Phase Induction Motor - Squirrel Cage



Customer :

Product line : NEMA Premium Efficiency Three-Phase

Product code : 12598765

Catalog # : 01512ET3E284JM-W22

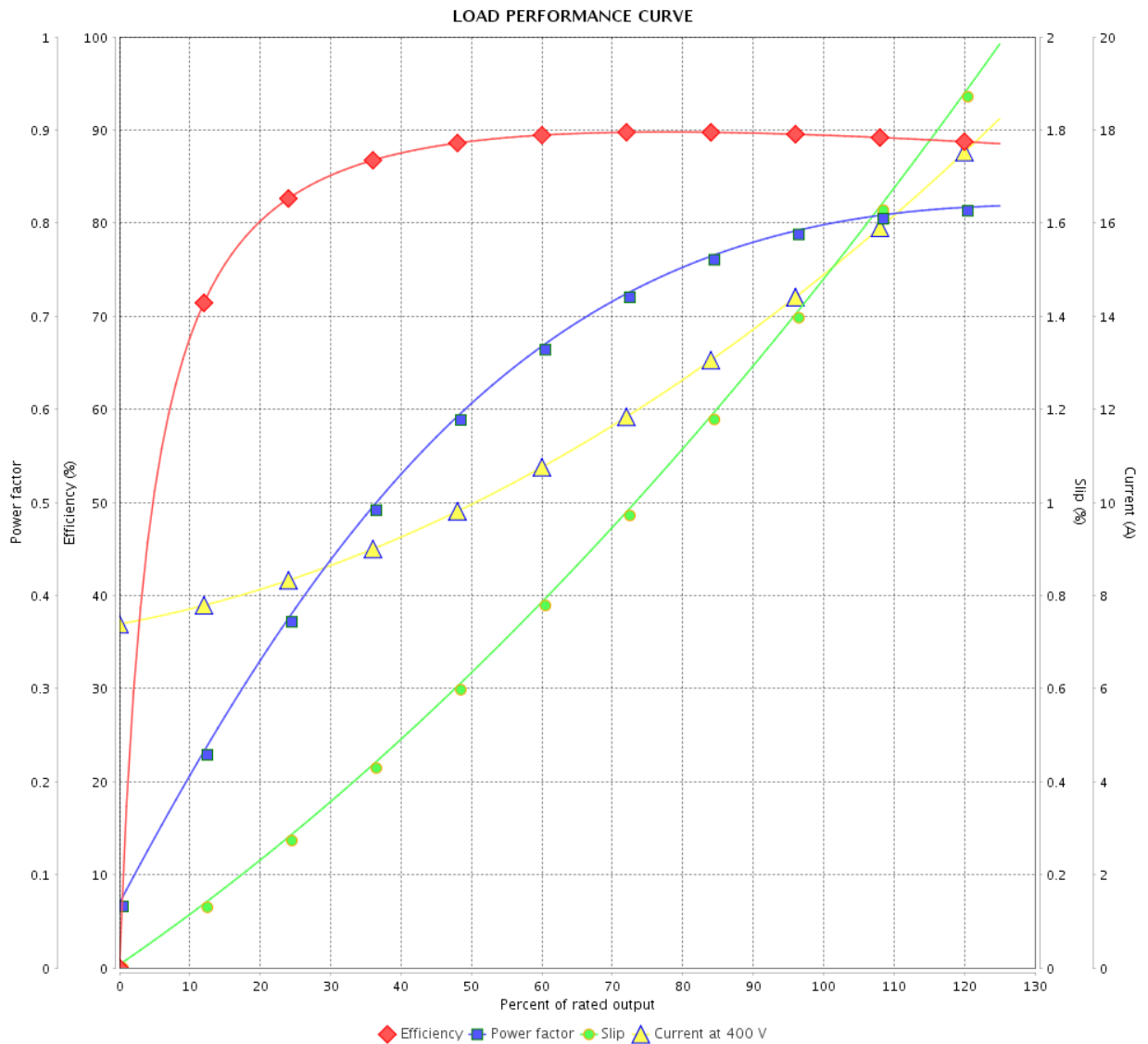

Performance : 400 V 50 Hz 6P IE3

Rated current : 15.1 A  
 LRC : 7.9  
 Rated torque : 53.3 ft.lb  
 Locked rotor torque : 300 %  
 Breakdown torque : 340 %  
 Rated speed : 985 rpm

Moment of inertia (J) : 7.85 sq.ft.lb  
 Duty cycle : Cont.(S1)  
 Insulation class : F  
 Service factor : 1.25  
 Temperature rise : 80 K  
 Design : B

Rev.	Changes Summary	Performed	Checked	Date
Performed by		Page		Revision
Checked by		11 / 36		
Date		13/04/2022		

# LOAD PERFORMANCE CURVE

Three Phase Induction Motor - Squirrel Cage



Customer :

Product line : NEMA Premium Efficiency Three-Phase

Product code : 12598765

Catalog # : 01512ET3E284JM-W22

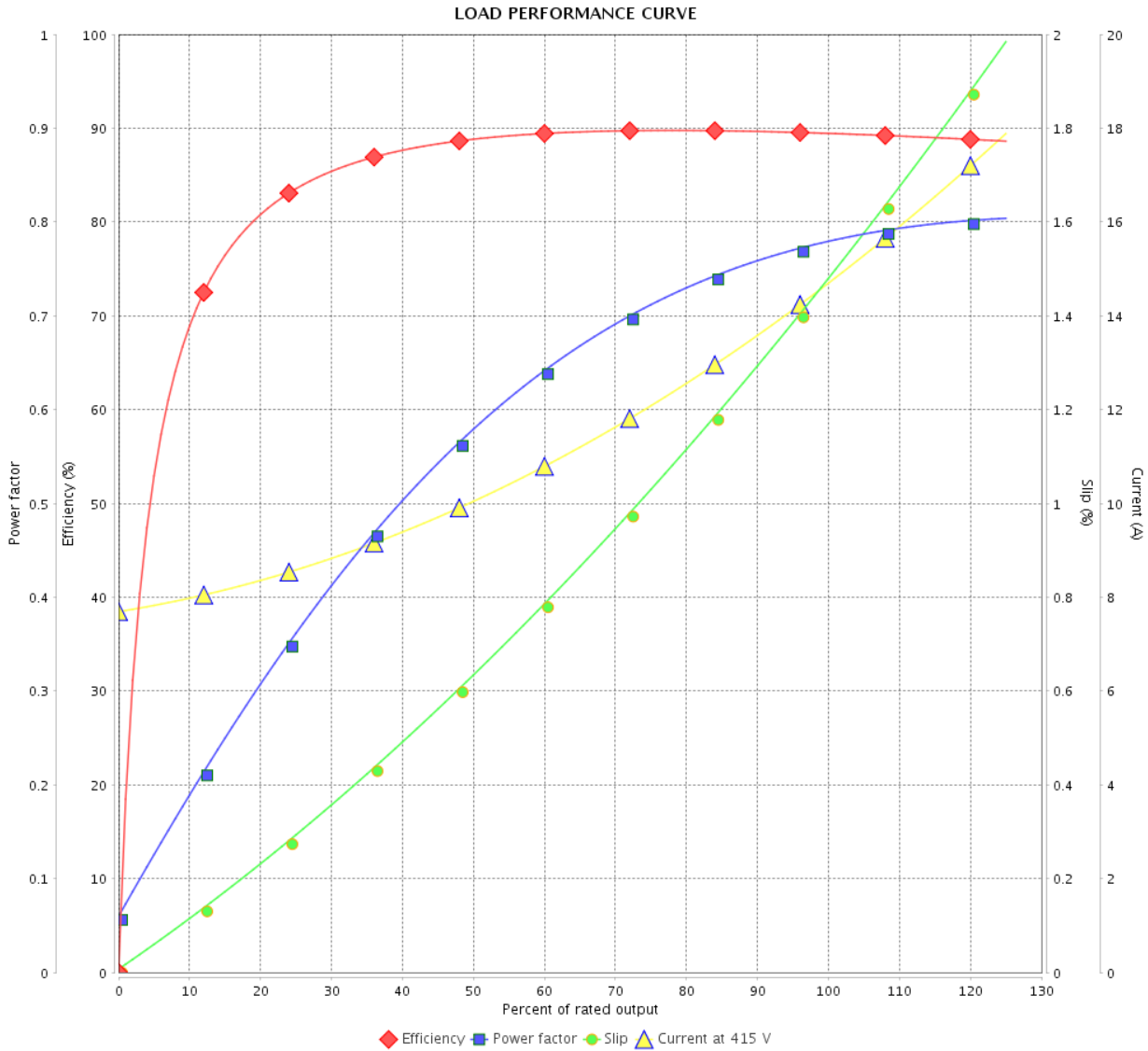

Performance : 415 V 50 Hz 6P IE3

Rated current	: 14.9 A	Moment of inertia (J)	: 7.85 sq.ft.lb
LRC	: 8.3	Duty cycle	: Cont.(S1)
Rated torque	: 53.3 ft.lb	Insulation class	: F
Locked rotor torque	: 330 %	Service factor	: 1.25
Breakdown torque	: 360 %	Temperature rise	: 80 K
Rated speed	: 985 rpm	Design	: B

Rev.	Changes Summary	Performed	Checked	Date
Performed by			Page 12 / 36	Revision
Checked by				
Date	13/04/2022			

# LOAD PERFORMANCE CURVE

## Three Phase Induction Motor - Squirrel Cage



Customer : \_\_\_\_\_

Product line : NEMA Premium Efficiency Three-Phase

Product code : 12598765

Catalog # : 01512ET3E284JM-W22

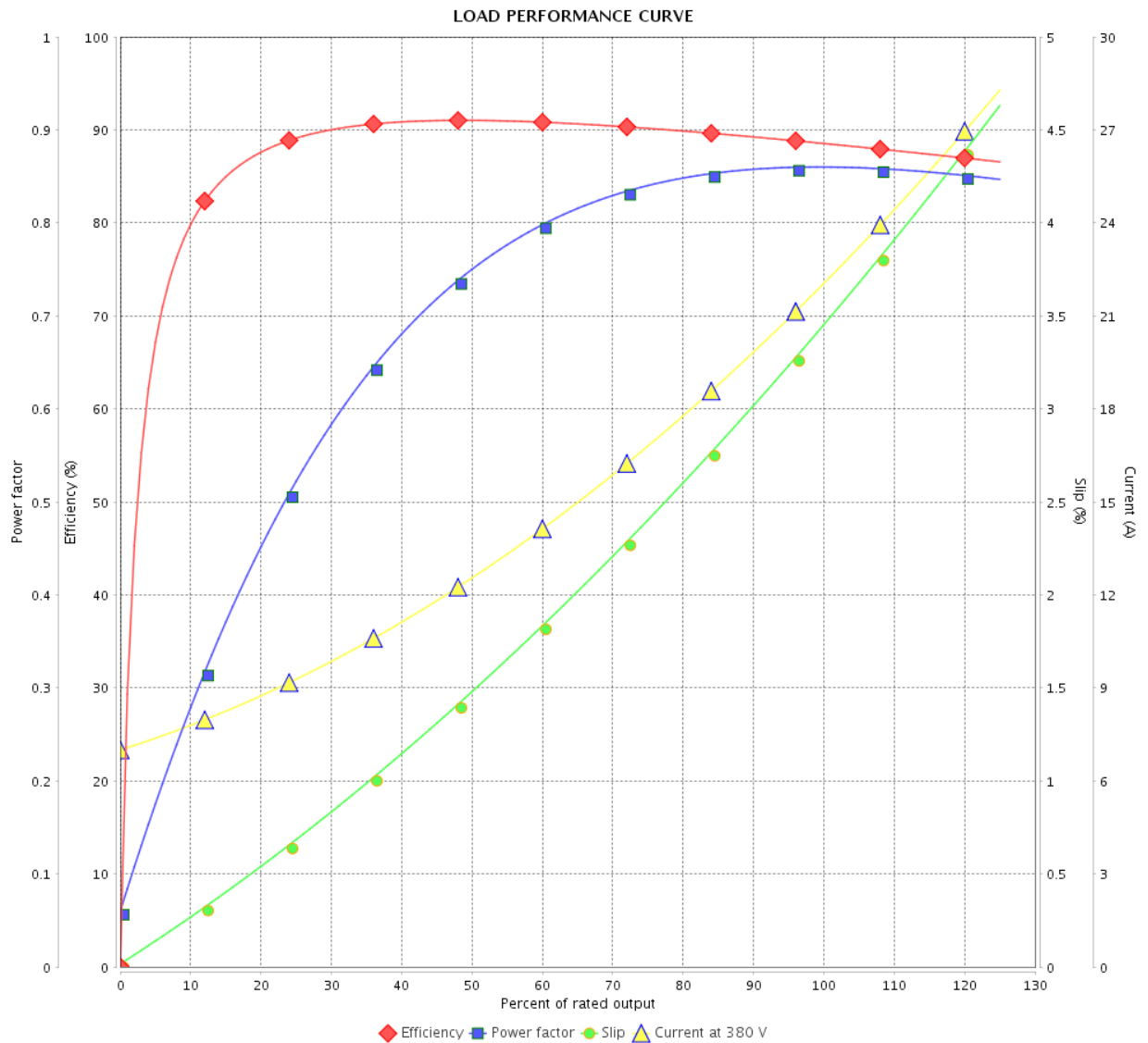

Performance : 380 V 50 Hz 6P IE1

Rated current : 22.0 A  
 LRC : 4.7  
 Rated torque : 81.6 ft.lb  
 Locked rotor torque : 170 %  
 Breakdown torque : 210 %  
 Rated speed : 965 rpm

Moment of inertia (J) : 7.85 sq.ft.lb  
 Duty cycle : Cont.(S1)  
 Insulation class : F  
 Service factor : 1.00  
 Temperature rise : 80 K  
 Design : B

Rev.	Changes Summary	Performed	Checked	Date
Performed by		Page		Revision
Checked by		13 / 36		
Date		13/04/2022		

# LOAD PERFORMANCE CURVE

Three Phase Induction Motor - Squirrel Cage



Customer :

Product line : NEMA Premium Efficiency Three-Phase

Product code : 12598765

Catalog # : 01512ET3E284JM-W22

LOAD PERFORMANCE CURVE

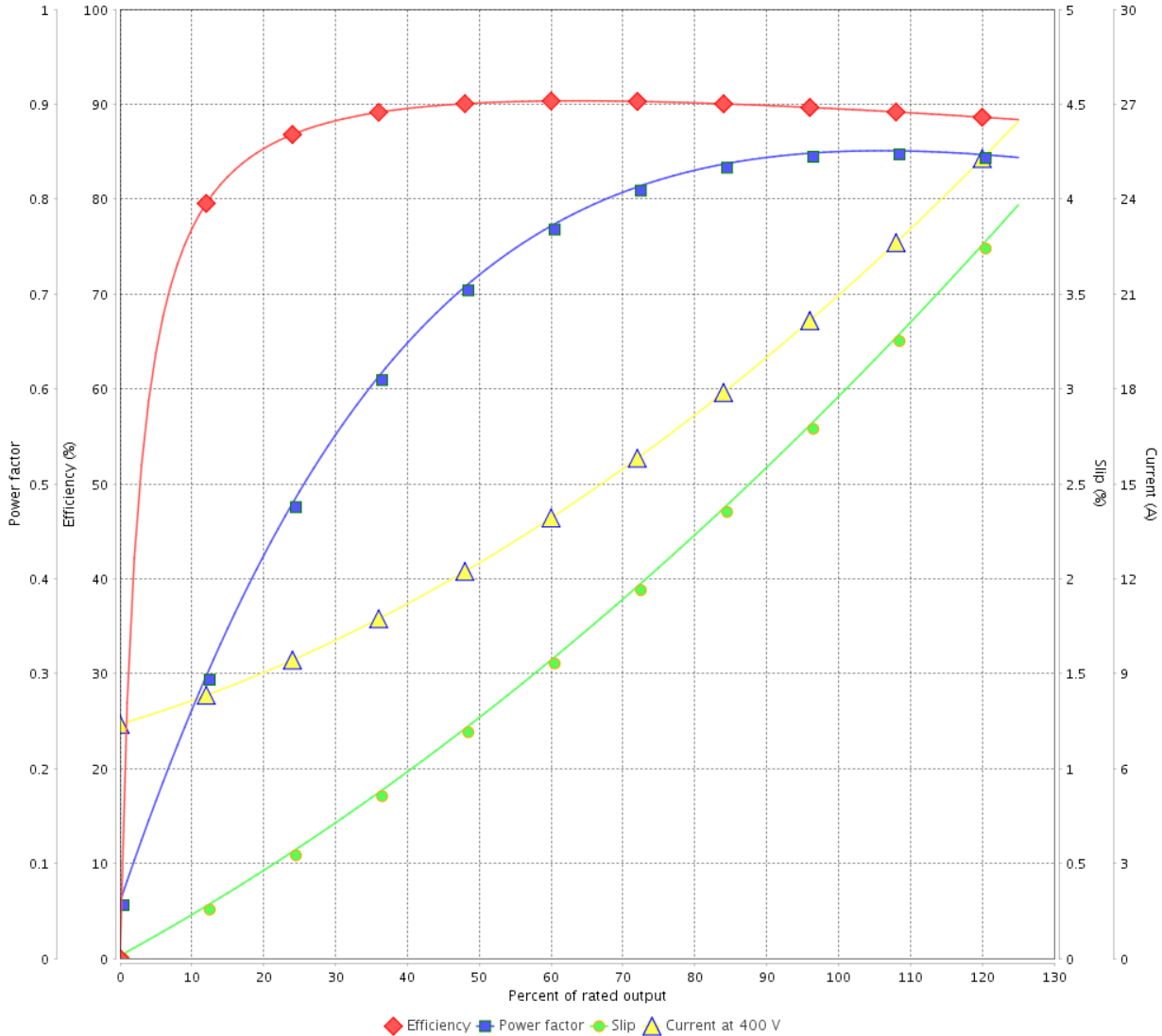

Performance : 400 V 50 Hz 6P IE2

Rated current : 20.9 A  
 LRC : 5.3  
 Rated torque : 81.2 ft.lb  
 Locked rotor torque : 200 %  
 Breakdown torque : 229 %  
 Rated speed : 970 rpm

Moment of inertia (J) : 7.85 sq.ft.lb  
 Duty cycle : Cont.(S1)  
 Insulation class : F  
 Service factor : 1.15  
 Temperature rise : 80 K  
 Design : B

Rev.	Changes Summary	Performed	Checked	Date
Performed by			Page 14 / 36	Revision
Checked by				
Date	13/04/2022			

# LOAD PERFORMANCE CURVE

## Three Phase Induction Motor - Squirrel Cage



Customer :

Product line : NEMA Premium Efficiency Three-Phase

Product code : 12598765

Catalog # : 01512ET3E284JM-W22

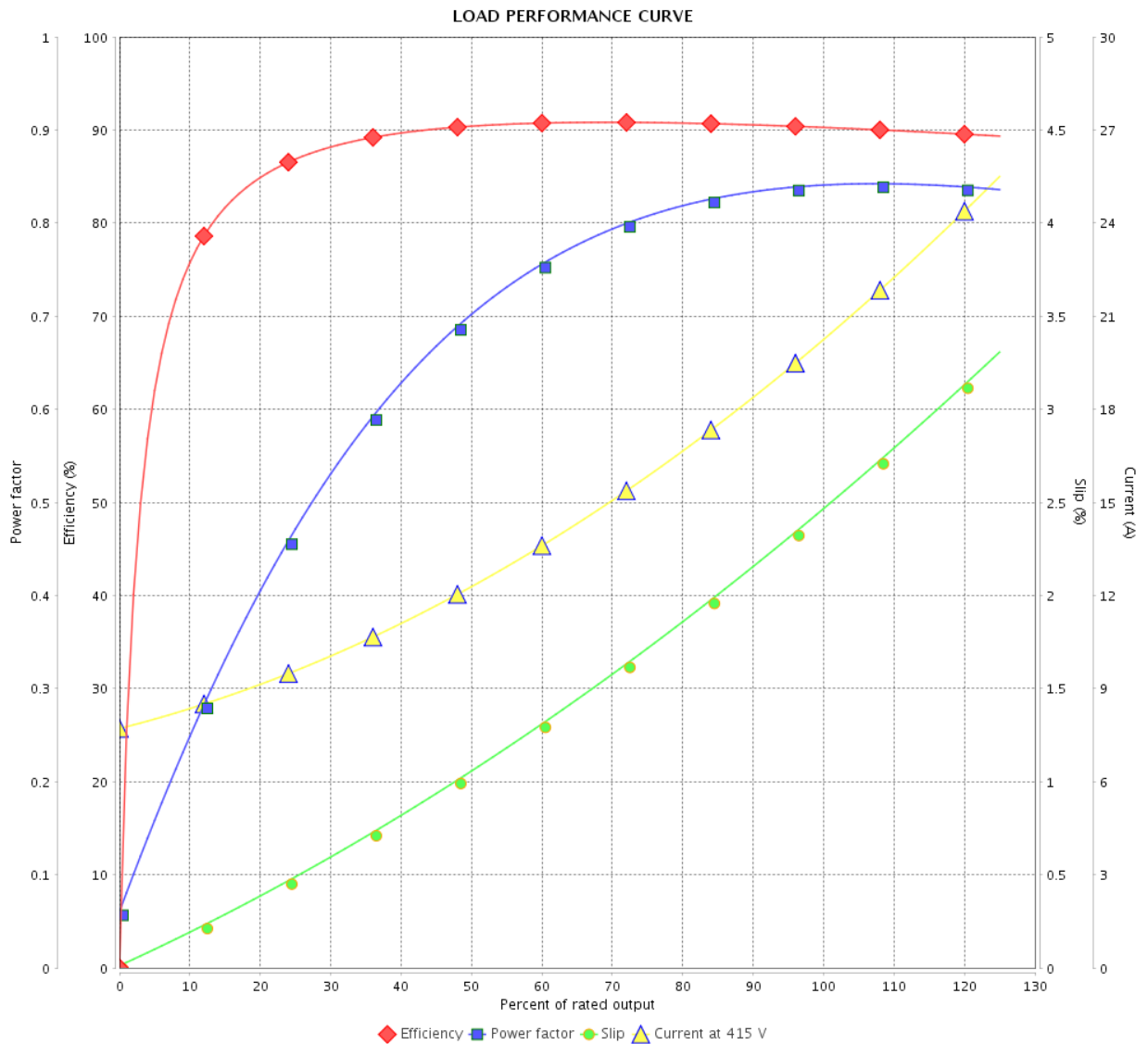

Performance : 415 V 50 Hz 6P IE2

Rated current : 20.2 A  
 LRC : 5.7  
 Rated torque : 80.8 ft.lb  
 Locked rotor torque : 220 %  
 Breakdown torque : 250 %  
 Rated speed : 975 rpm

Moment of inertia (J) : 7.85 sq.ft.lb  
 Duty cycle : Cont.(S1)  
 Insulation class : F  
 Service factor : 1.15  
 Temperature rise : 80 K  
 Design : B

Rev.	Changes Summary	Performed	Checked	Date
Performed by		Page		Revision
Checked by		15 / 36		
Date		13/04/2022		

# THERMAL LIMIT CURVE



## Three Phase Induction Motor - Squirrel Cage

Customer :

Product line : NEMA Premium Efficiency Three-Phase  
Product code : 12598765  
Catalog # : 01512ET3E284JM-W22

Performance : 230/460 V 60 Hz 6P

Rated current	: 35.8/17.9 A	Moment of inertia (J)	: 7.85 sq.ft.lb
LRC	: 6.4	Duty cycle	: Cont.(S1)
Rated torque	: 67.0 ft.lb	Insulation class	: F
Locked rotor torque	: 229 %	Service factor	: 1.25
Breakdown torque	: 260 %	Temperature rise	: 80 K
Rated speed	: 1175 rpm	Design	: B

Heating constant

Cooling constant

Rev.	Changes Summary	Performed	Checked	Date
Performed by				
Checked by			Page	Revision
Date	13/04/2022		16 / 36	



# THERMAL LIMIT CURVE

Three Phase Induction Motor - Squirrel Cage



Customer : \_\_\_\_\_

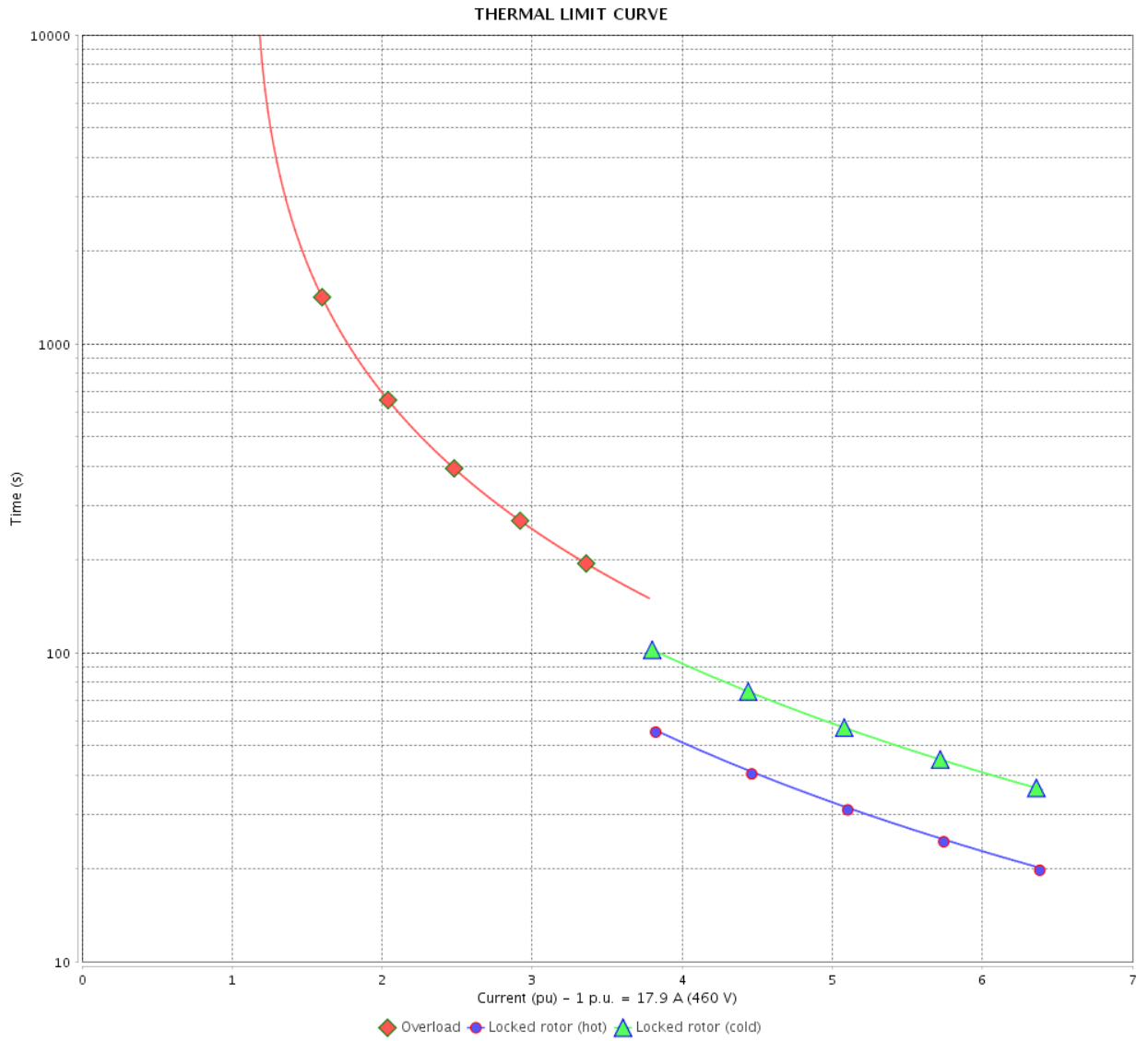

Rev.	Changes Summary	Performed	Checked	Date
Performed by		Page		Revision
Checked by		17 / 36		
Date		13/04/2022		

# THERMAL LIMIT CURVE



## Three Phase Induction Motor - Squirrel Cage

Customer :

Product line : NEMA Premium Efficiency Three-Phase  
Product code : 12598765  
Catalog # : 01512ET3E284JM-W22

Performance : 380 V 50 Hz 6P IE3

Rated current	: 15.5 A	Moment of inertia (J)	: 7.85 sq.ft.lb
LRC	: 7.2	Duty cycle	: Cont.(S1)
Rated torque	: 53.3 ft.lb	Insulation class	: F
Locked rotor torque	: 270 %	Service factor	: 1.25
Breakdown torque	: 300 %	Temperature rise	: 80 K
Rated speed	: 985 rpm	Design	: B

Heating constant

Cooling constant

Rev.	Changes Summary	Performed	Checked	Date
Performed by				
Checked by			Page	Revision
Date	13/04/2022		18 / 36	

# THERMAL LIMIT CURVE

Three Phase Induction Motor - Squirrel Cage



Customer : \_\_\_\_\_

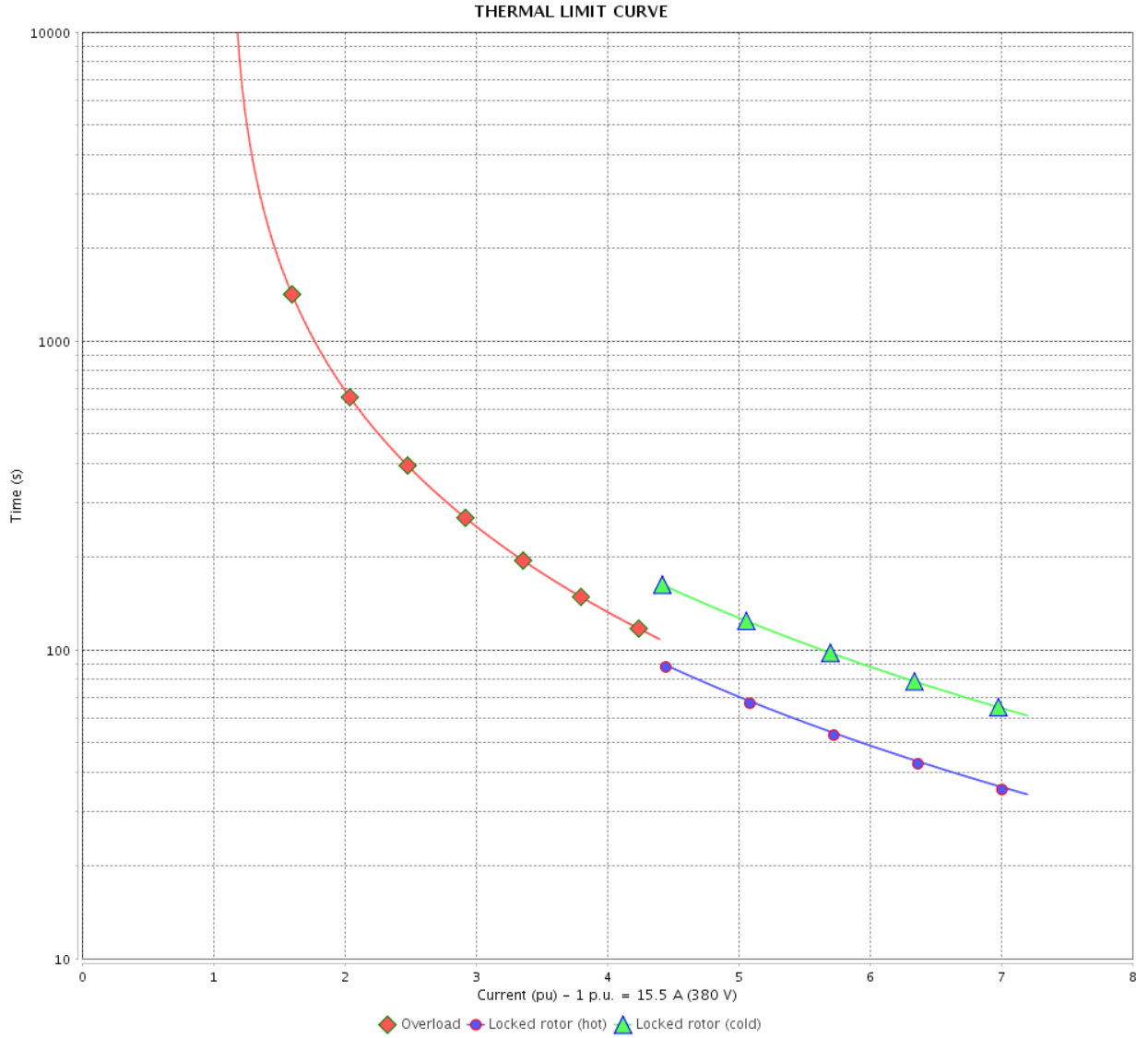

Rev.	Changes Summary	Performed	Checked	Date
Performed by		Page 19 / 36		Revision
Checked by				
Date				

# THERMAL LIMIT CURVE



## Three Phase Induction Motor - Squirrel Cage

Customer :

Product line : NEMA Premium Efficiency Three-Phase  
Product code : 12598765  
Catalog # : 01512ET3E284JM-W22

Performance : 400 V 50 Hz 6P IE3

Rated current	: 15.1 A	Moment of inertia (J)	: 7.85 sq.ft.lb
LRC	: 7.9	Duty cycle	: Cont.(S1)
Rated torque	: 53.3 ft.lb	Insulation class	: F
Locked rotor torque	: 300 %	Service factor	: 1.25
Breakdown torque	: 340 %	Temperature rise	: 80 K
Rated speed	: 985 rpm	Design	: B

Heating constant

Cooling constant

Rev.	Changes Summary	Performed	Checked	Date
Performed by				
Checked by			Page	Revision
Date	13/04/2022		20 / 36	

# THERMAL LIMIT CURVE

Three Phase Induction Motor - Squirrel Cage



Customer : \_\_\_\_\_

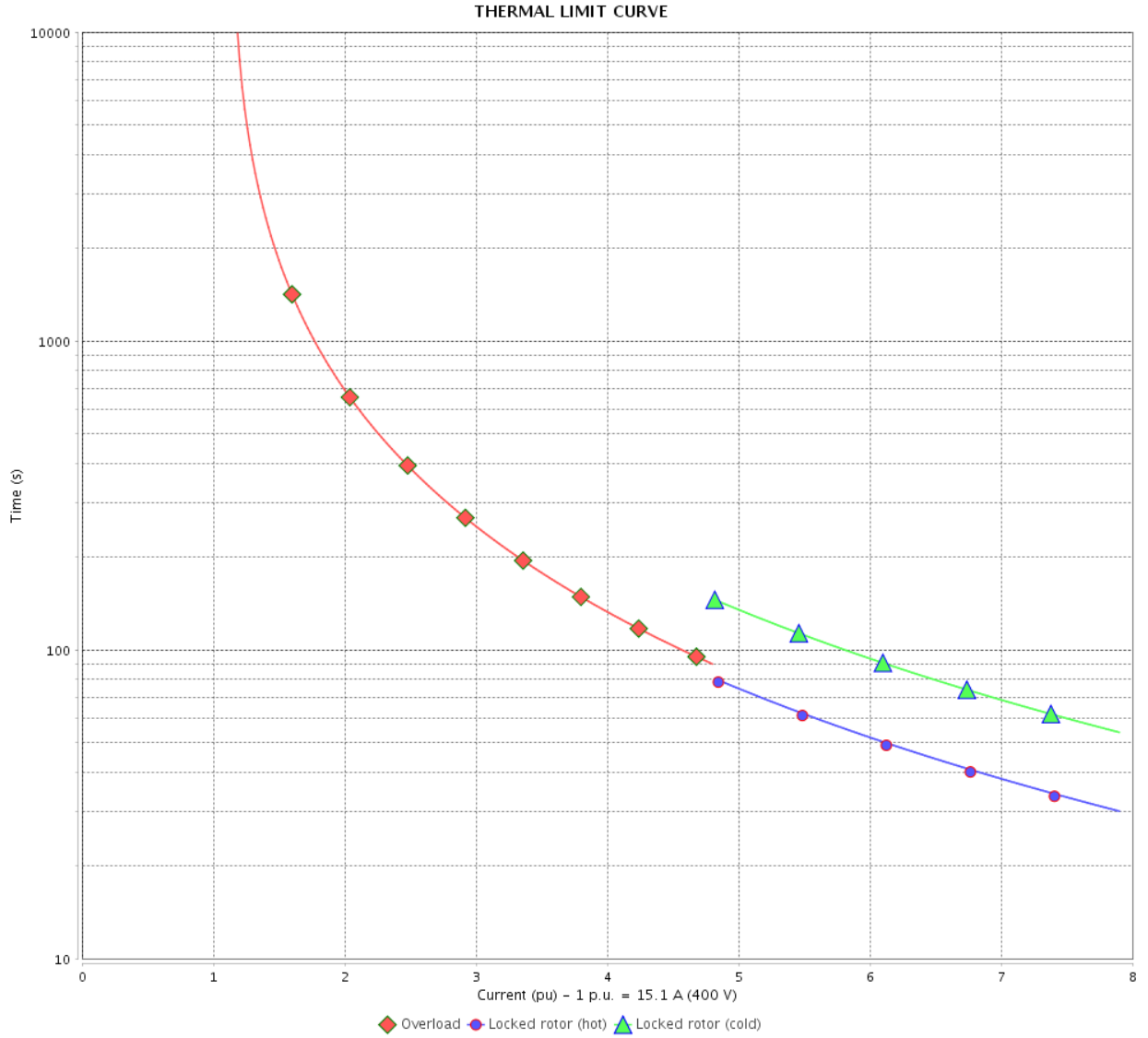

Rev.	Changes Summary	Performed	Checked	Date
Performed by		Page 21 / 36		Revision
Checked by				
Date				

# THERMAL LIMIT CURVE

## Three Phase Induction Motor - Squirrel Cage



Customer :

Product line : NEMA Premium Efficiency Three-Phase  
Product code : 12598765  
Catalog # : 01512ET3E284JM-W22

Performance : 415 V 50 Hz 6P IE3

Rated current	: 14.9 A	Moment of inertia (J)	: 7.85 sq.ft.lb
LRC	: 8.3	Duty cycle	: Cont.(S1)
Rated torque	: 53.3 ft.lb	Insulation class	: F
Locked rotor torque	: 330 %	Service factor	: 1.25
Breakdown torque	: 360 %	Temperature rise	: 80 K
Rated speed	: 985 rpm	Design	: B

Heating constant

Cooling constant

Rev.	Changes Summary	Performed	Checked	Date
Performed by				
Checked by			Page	Revision
Date	13/04/2022		22 / 36	

# THERMAL LIMIT CURVE

Three Phase Induction Motor - Squirrel Cage



Customer : \_\_\_\_\_

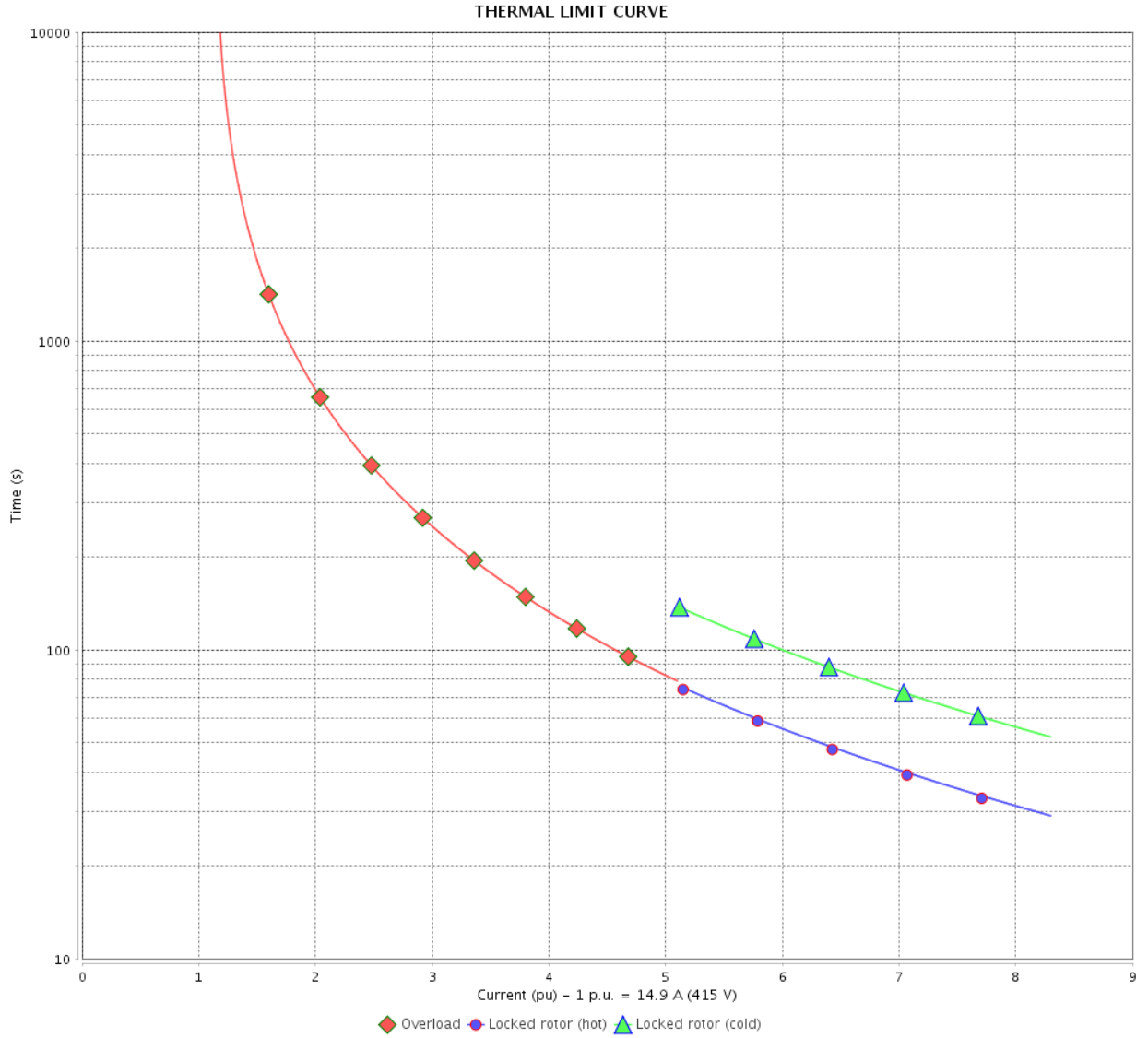

Rev.	Changes Summary	Performed	Checked	Date
Performed by		Page		Revision
Checked by		23 / 36		
Date		13/04/2022		

# THERMAL LIMIT CURVE

## Three Phase Induction Motor - Squirrel Cage



Customer :

Product line : NEMA Premium Efficiency Three-Phase  
Product code : 12598765  
Catalog # : 01512ET3E284JM-W22

Performance : 380 V 50 Hz 6P IE1

Rated current	: 22.0 A	Moment of inertia (J)	: 7.85 sq.ft.lb
LRC	: 4.7	Duty cycle	: Cont.(S1)
Rated torque	: 81.6 ft.lb	Insulation class	: F
Locked rotor torque	: 170 %	Service factor	: 1.00
Breakdown torque	: 210 %	Temperature rise	: 80 K
Rated speed	: 965 rpm	Design	: B

Heating constant

Cooling constant

Rev.	Changes Summary	Performed	Checked	Date
Performed by				
Checked by			Page	Revision
Date	13/04/2022		24 / 36	



# THERMAL LIMIT CURVE

Three Phase Induction Motor - Squirrel Cage



Customer : \_\_\_\_\_

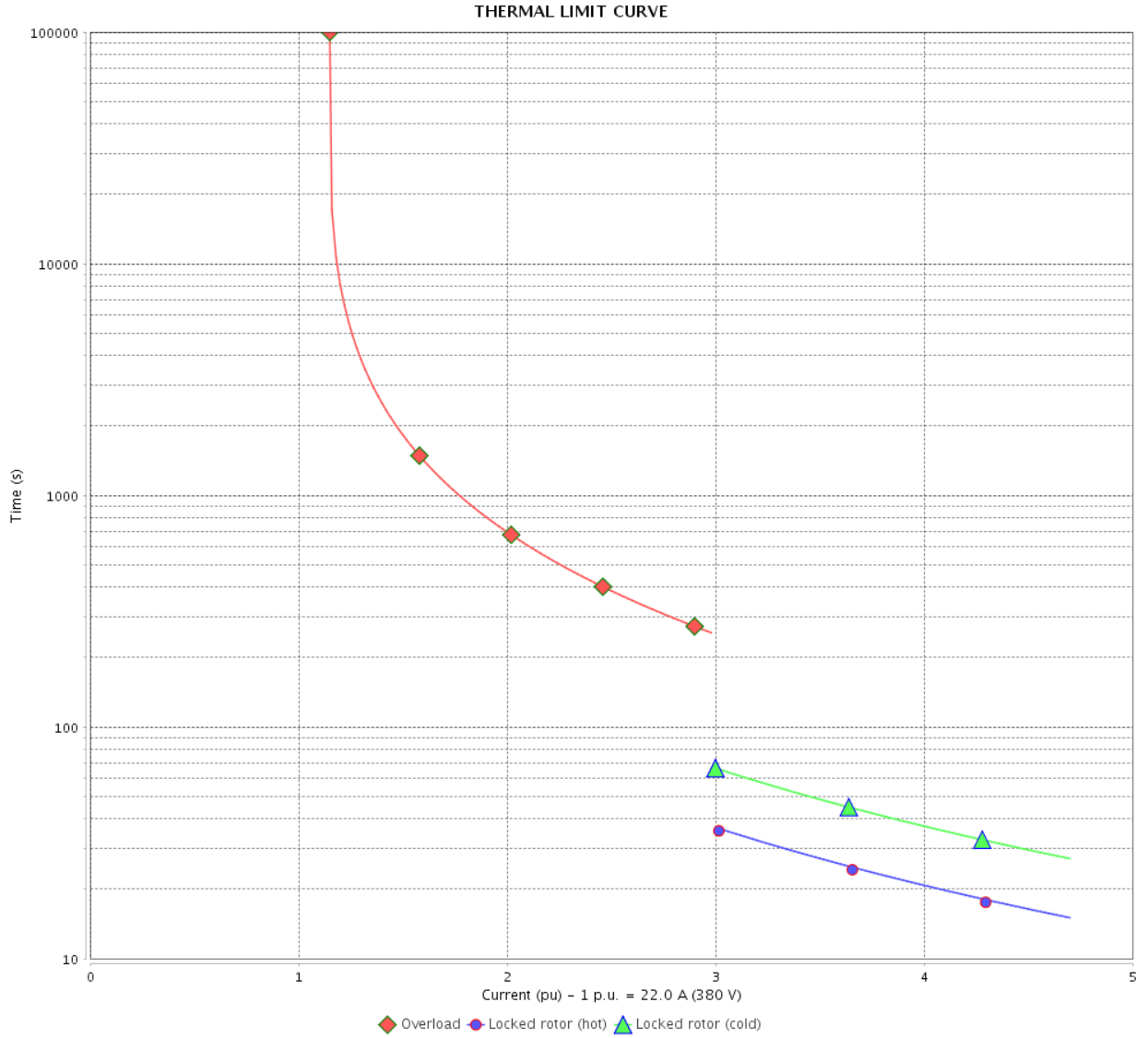

Rev.	Changes Summary	Performed	Checked	Date
Performed by		Page		Revision
Checked by		25 / 36		
Date		13/04/2022		

# THERMAL LIMIT CURVE

## Three Phase Induction Motor - Squirrel Cage



Customer :

Product line : NEMA Premium Efficiency Three-Phase  
Product code : 12598765  
Catalog # : 01512ET3E284JM-W22

Performance : 400 V 50 Hz 6P IE2

Rated current	: 20.9 A	Moment of inertia (J)	: 7.85 sq.ft.lb
LRC	: 5.3	Duty cycle	: Cont.(S1)
Rated torque	: 81.2 ft.lb	Insulation class	: F
Locked rotor torque	: 200 %	Service factor	: 1.15
Breakdown torque	: 229 %	Temperature rise	: 80 K
Rated speed	: 970 rpm	Design	: B

Heating constant

Cooling constant

Rev.	Changes Summary	Performed	Checked	Date
Performed by				
Checked by			Page	Revision
Date	13/04/2022		26 / 36	

# THERMAL LIMIT CURVE

Three Phase Induction Motor - Squirrel Cage



Customer : \_\_\_\_\_

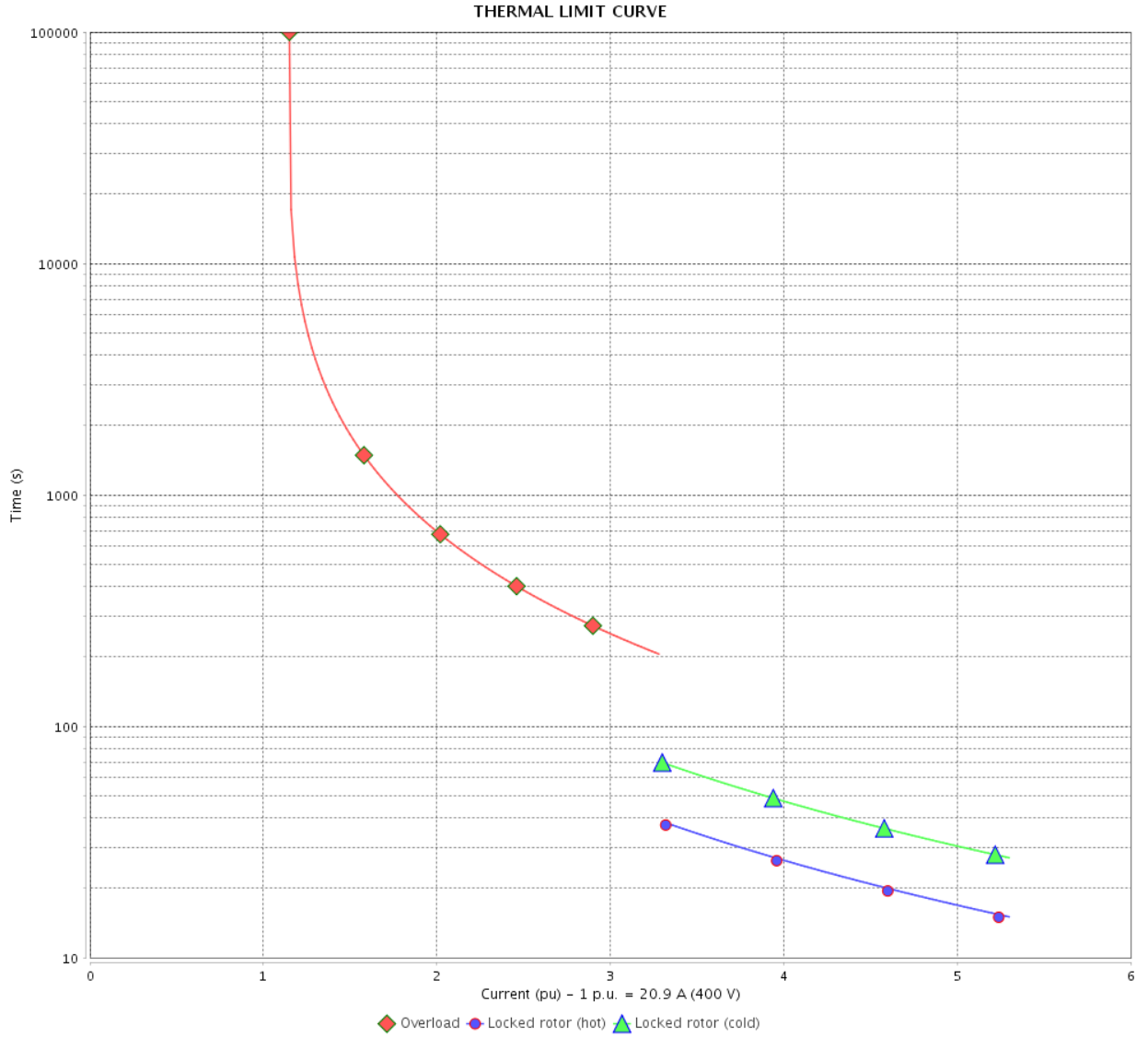

Rev.	Changes Summary	Performed	Checked	Date
Performed by		Page		Revision
Checked by		27 / 36		
Date		13/04/2022		

# THERMAL LIMIT CURVE



## Three Phase Induction Motor - Squirrel Cage

Customer :

Product line : NEMA Premium Efficiency Three-Phase  
Product code : 12598765  
Catalog # : 01512ET3E284JM-W22

Performance : 415 V 50 Hz 6P IE2

Rated current	: 20.2 A	Moment of inertia (J)	: 7.85 sq.ft.lb
LRC	: 5.7	Duty cycle	: Cont.(S1)
Rated torque	: 80.8 ft.lb	Insulation class	: F
Locked rotor torque	: 220 %	Service factor	: 1.15
Breakdown torque	: 250 %	Temperature rise	: 80 K
Rated speed	: 975 rpm	Design	: B

Heating constant

Cooling constant

Rev.	Changes Summary	Performed	Checked	Date
Performed by				
Checked by			Page	Revision
Date	13/04/2022		28 / 36	

# THERMAL LIMIT CURVE

Three Phase Induction Motor - Squirrel Cage



Customer : \_\_\_\_\_

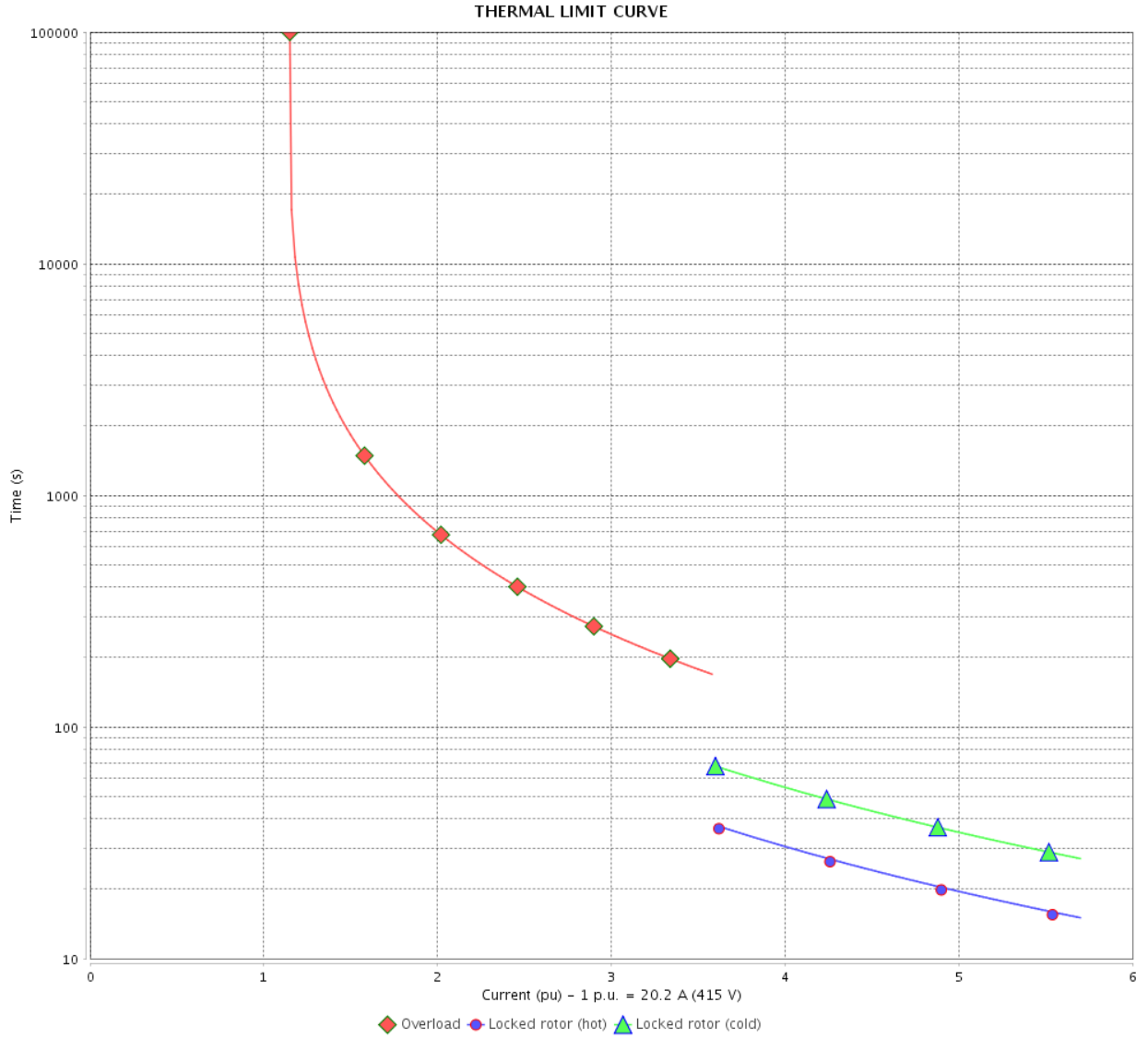

Rev.	Changes Summary	Performed	Checked	Date
Performed by		Page 29 / 36		Revision
Checked by				
Date				

# VFD OPERATION CURVE

Three Phase Induction Motor - Squirrel Cage



Customer :

Product line : NEMA Premium Efficiency Three-Phase

Product code : 12598765

Catalog # : 01512ET3E284JM-W22

VFD OPERATION CURVE

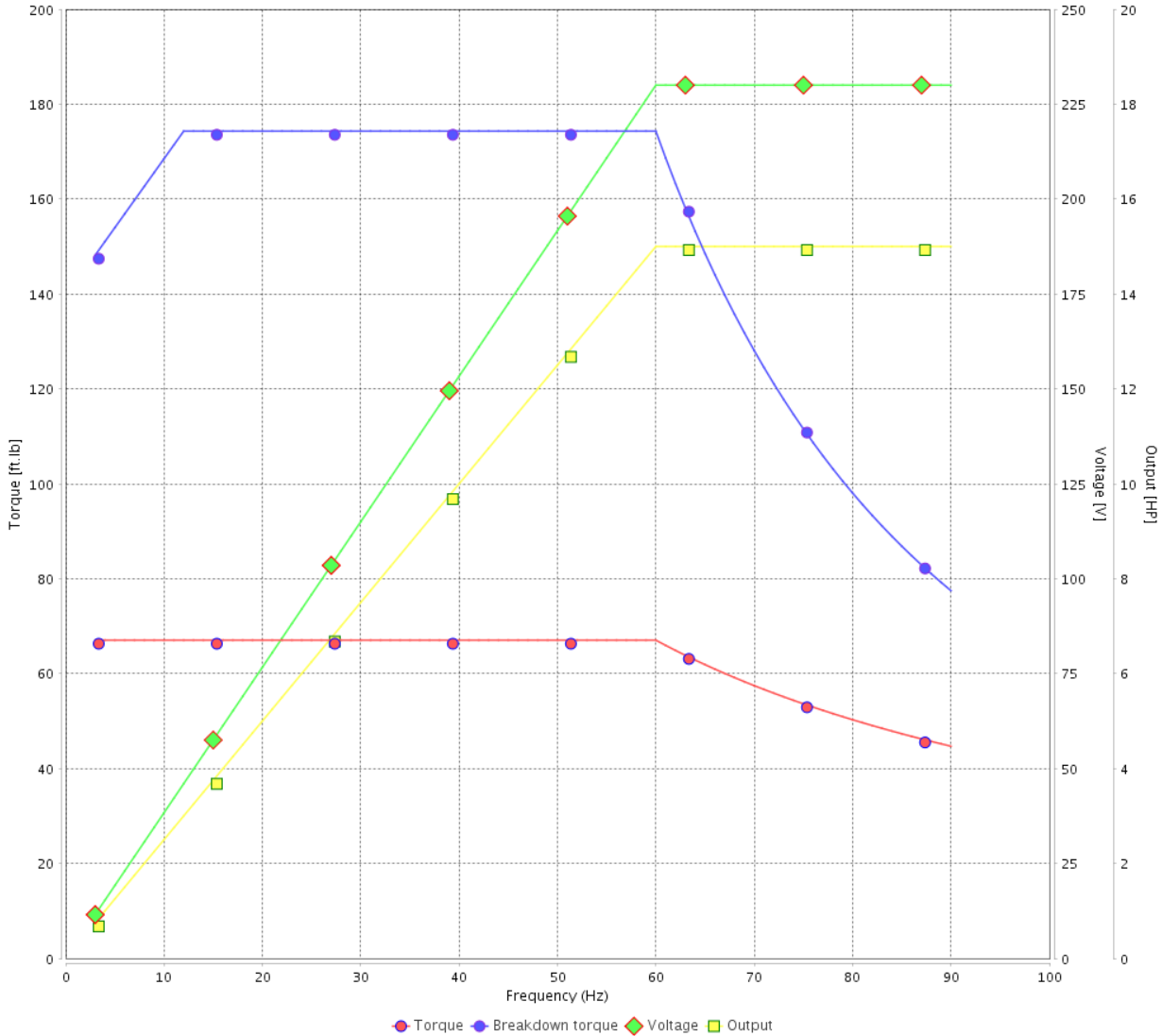

Performance : 230/460 V 60 Hz 6P

Rated current : 35.8/17.9 A  
 LRC : 6.4  
 Rated torque : 67.0 ft.lb  
 Locked rotor torque : 229 %  
 Breakdown torque : 260 %  
 Rated speed : 1175 rpm

Moment of inertia (J) : 7.85 sq.ft.lb  
 Duty cycle : Cont.(S1)  
 Insulation class : F  
 Service factor : 1.25  
 Temperature rise : 80 K  
 Design : B

Rev.	Changes Summary	Performed	Checked	Date
Performed by			Page 30 / 36	Revision
Checked by				
Date	13/04/2022			

# VFD OPERATION CURVE

## Three Phase Induction Motor - Squirrel Cage



Customer :

Product line : NEMA Premium Efficiency Three-Phase

Product code : 12598765

Catalog # : 01512ET3E284JM-W22

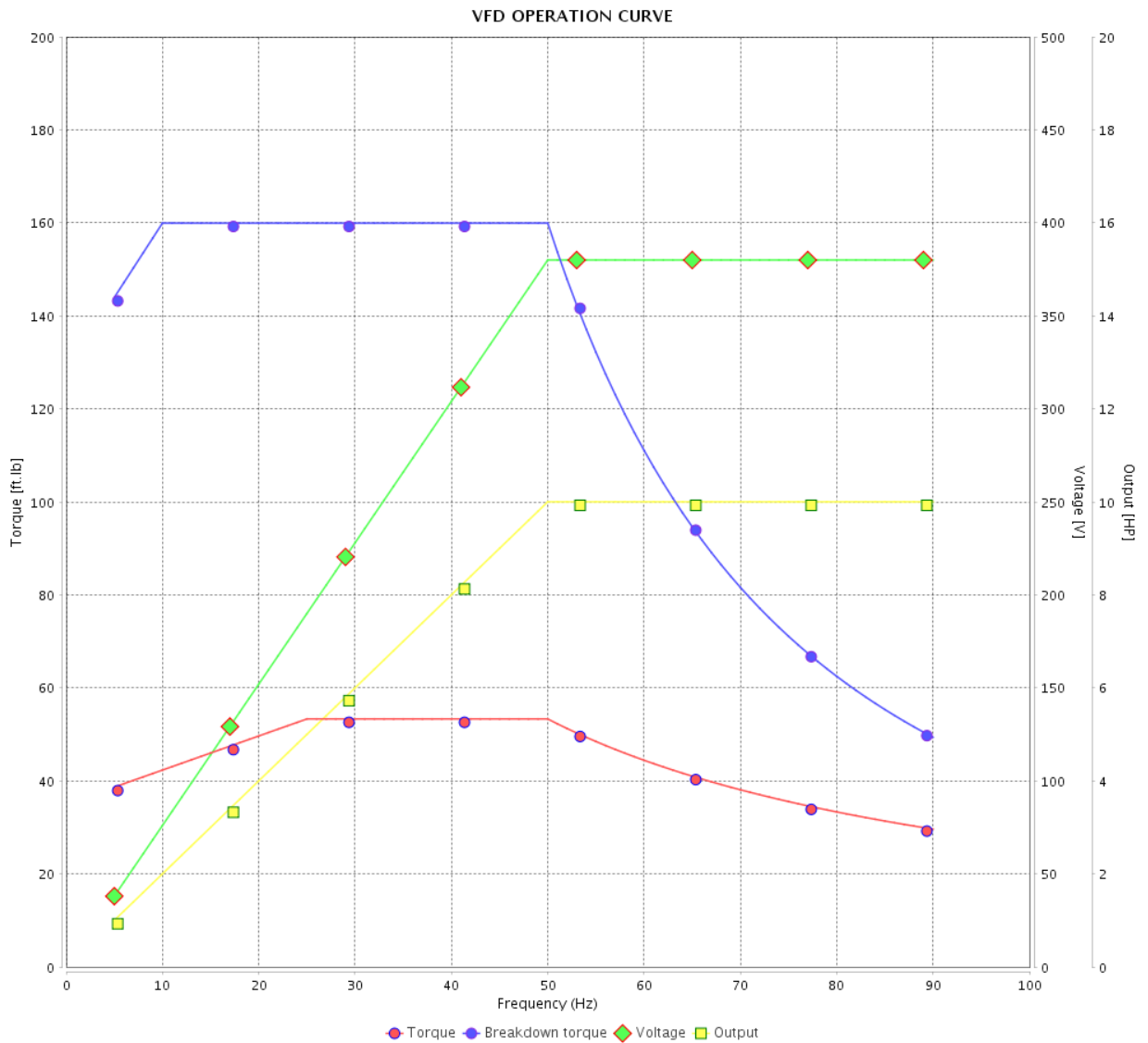

Performance : 380 V 50 Hz 6P IE3

Rated current : 15.5 A  
 LRC : 7.2  
 Rated torque : 53.3 ft.lb  
 Locked rotor torque : 270 %  
 Breakdown torque : 300 %  
 Rated speed : 985 rpm

Moment of inertia (J) : 7.85 sq.ft.lb  
 Duty cycle : Cont.(S1)  
 Insulation class : F  
 Service factor : 1.25  
 Temperature rise : 80 K  
 Design : B

Rev.	Changes Summary	Performed	Checked	Date
Performed by			Page 31 / 36	Revision
Checked by				
Date	13/04/2022			

# VFD OPERATION CURVE

Three Phase Induction Motor - Squirrel Cage



Customer : \_\_\_\_\_

Product line : NEMA Premium Efficiency Three-Phase

Product code : 12598765

Catalog # : 01512ET3E284JM-W22

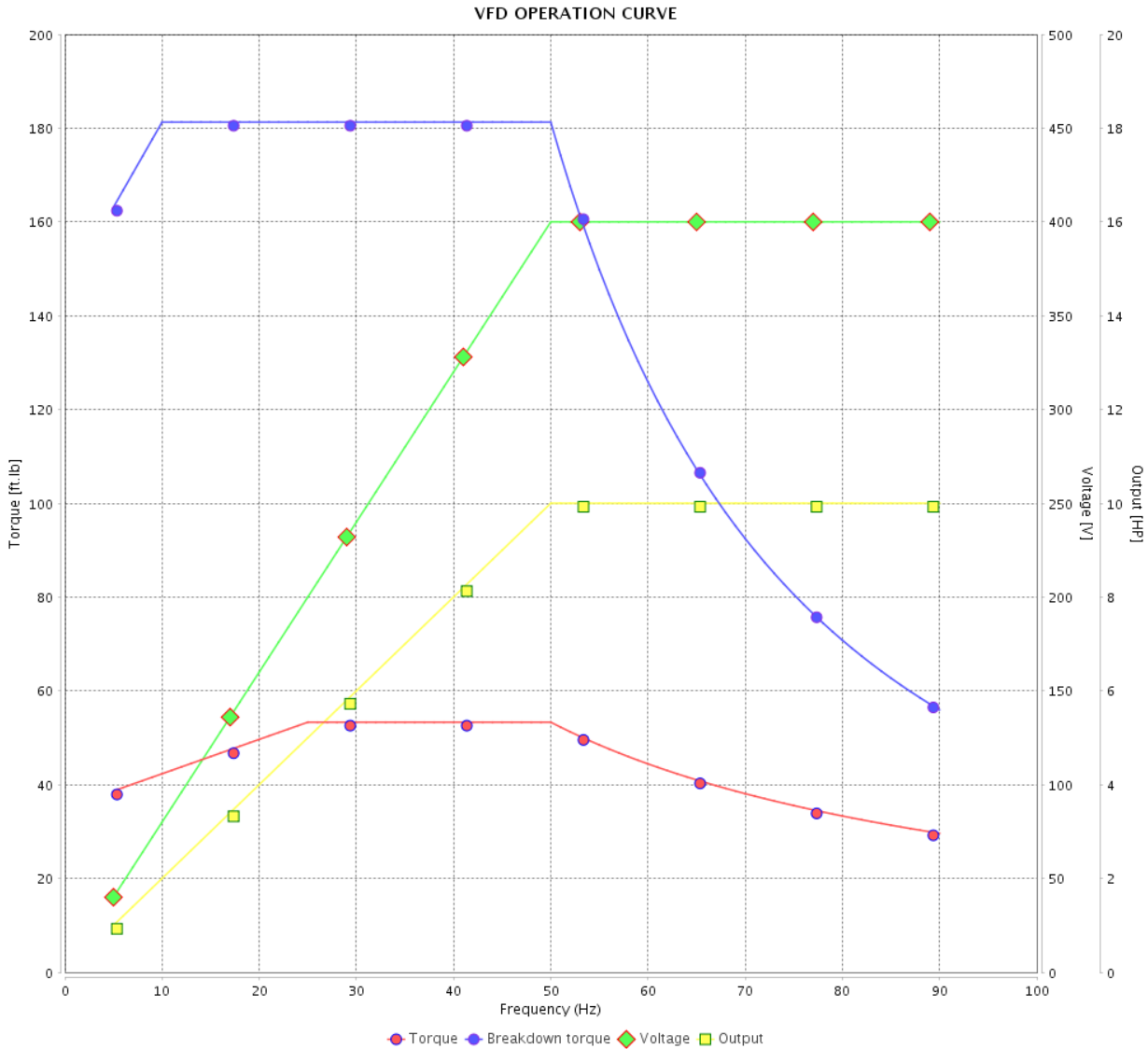

Performance : 400 V 50 Hz 6P IE3

Rated current : 15.1 A  
 LRC : 7.9  
 Rated torque : 53.3 ft.lb  
 Locked rotor torque : 300 %  
 Breakdown torque : 340 %  
 Rated speed : 985 rpm

Moment of inertia (J) : 7.85 sq.ft.lb  
 Duty cycle : Cont.(S1)  
 Insulation class : F  
 Service factor : 1.25  
 Temperature rise : 80 K  
 Design : B

Rev.	Changes Summary	Performed	Checked	Date
Performed by			Page 32 / 36	Revision
Checked by				
Date	13/04/2022			



# VFD OPERATION CURVE

## Three Phase Induction Motor - Squirrel Cage



Customer : \_\_\_\_\_

Product line : NEMA Premium Efficiency Three-Phase

Product code : 12598765

Catalog # : 01512ET3E284JM-W22

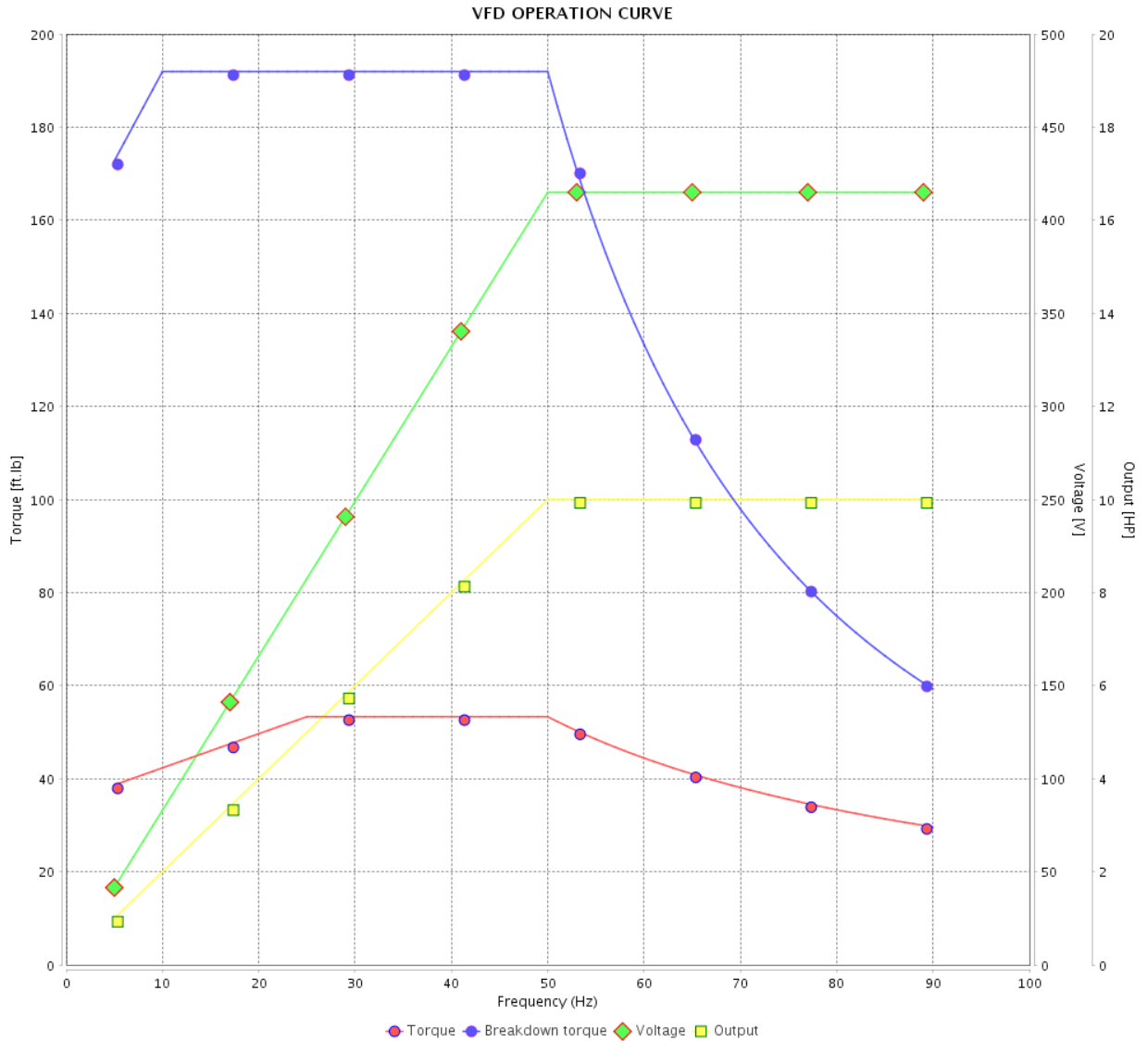

Performance : 415 V 50 Hz 6P IE3

Rated current : 14.9 A  
 LRC : 8.3  
 Rated torque : 53.3 ft.lb  
 Locked rotor torque : 330 %  
 Breakdown torque : 360 %  
 Rated speed : 985 rpm

Moment of inertia (J) : 7.85 sq.ft.lb  
 Duty cycle : Cont.(S1)  
 Insulation class : F  
 Service factor : 1.25  
 Temperature rise : 80 K  
 Design : B

Rev.	Changes Summary	Performed	Checked	Date
Performed by				Page 33 / 36
Checked by				
Date	13/04/2022			

# VFD OPERATION CURVE

Three Phase Induction Motor - Squirrel Cage



Customer :

Product line : NEMA Premium Efficiency Three-Phase

Product code : 12598765

Catalog # : 01512ET3E284JM-W22

VFD OPERATION CURVE

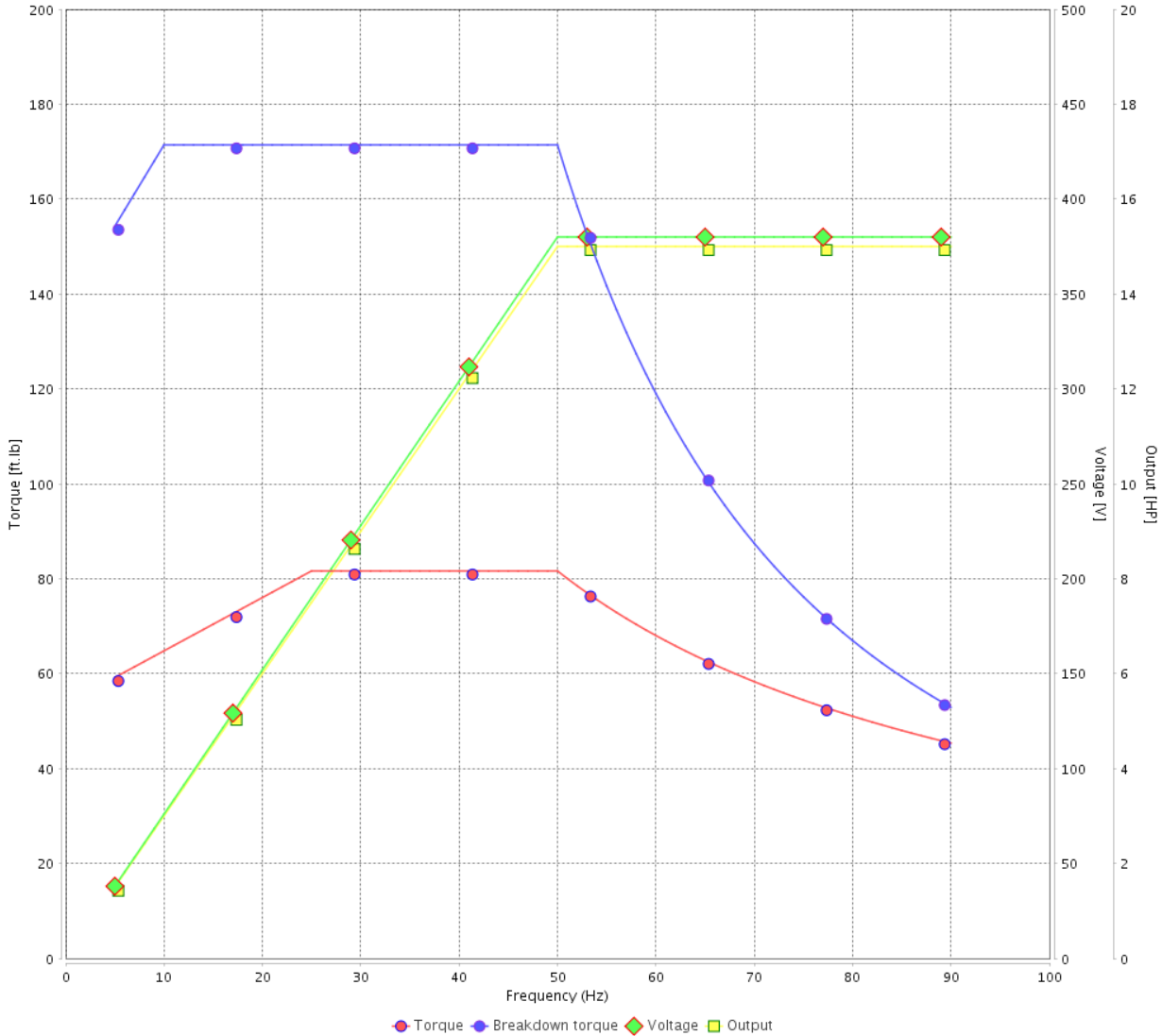

Performance : 380 V 50 Hz 6P IE1

Rated current : 22.0 A  
 LRC : 4.7  
 Rated torque : 81.6 ft.lb  
 Locked rotor torque : 170 %  
 Breakdown torque : 210 %  
 Rated speed : 965 rpm

Moment of inertia (J) : 7.85 sq.ft.lb  
 Duty cycle : Cont.(S1)  
 Insulation class : F  
 Service factor : 1.00  
 Temperature rise : 80 K  
 Design : B

Rev.	Changes Summary	Performed	Checked	Date
Performed by			Page 34 / 36	Revision
Checked by				
Date	13/04/2022			

# VFD OPERATION CURVE

## Three Phase Induction Motor - Squirrel Cage



Customer :

Product line : NEMA Premium Efficiency Three-Phase

Product code : 12598765

Catalog # : 01512ET3E284JM-W22

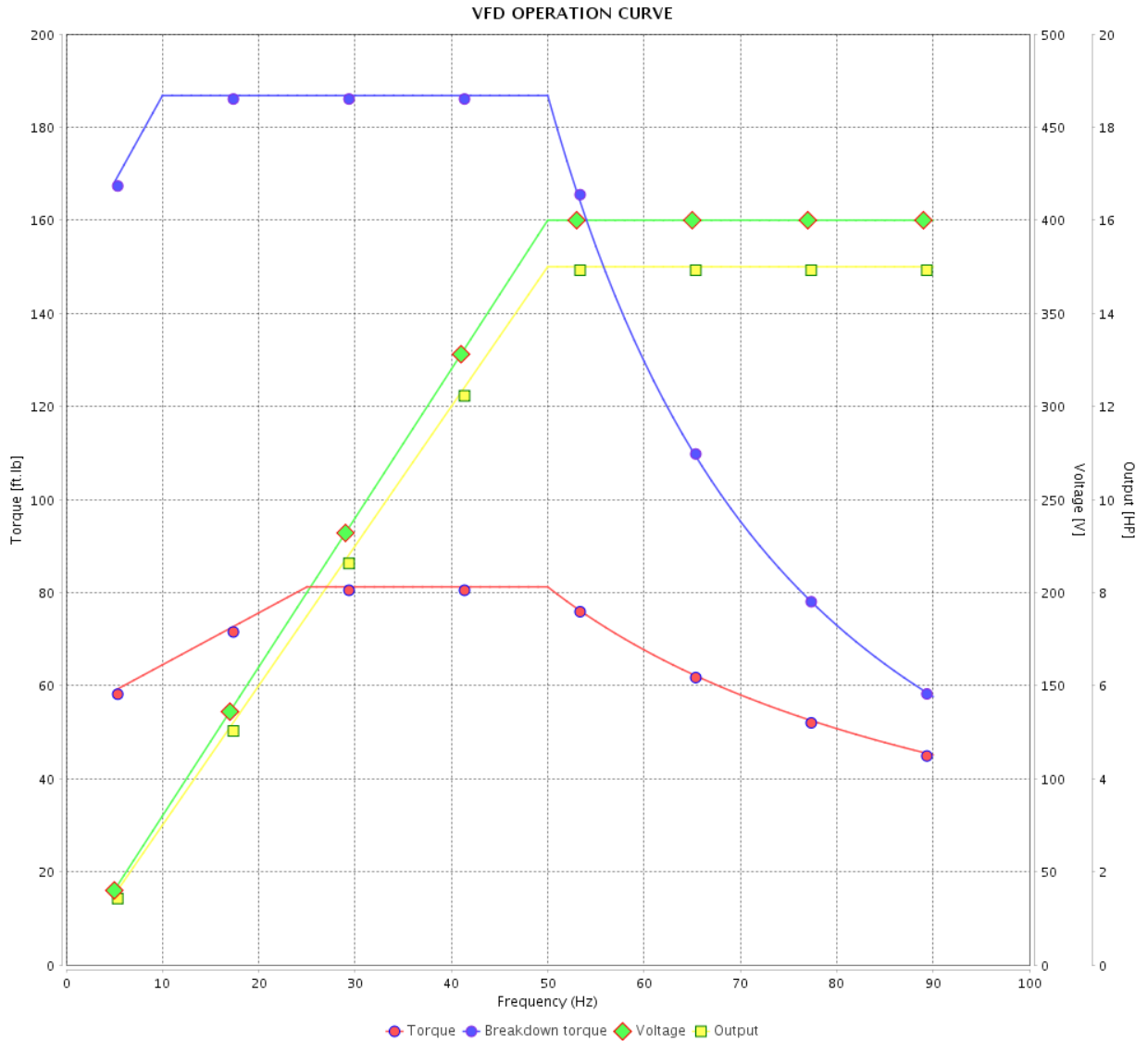

Performance : 400 V 50 Hz 6P IE2

Rated current : 20.9 A  
 LRC : 5.3  
 Rated torque : 81.2 ft.lb  
 Locked rotor torque : 200 %  
 Breakdown torque : 229 %  
 Rated speed : 970 rpm

Moment of inertia (J) : 7.85 sq.ft.lb  
 Duty cycle : Cont.(S1)  
 Insulation class : F  
 Service factor : 1.15  
 Temperature rise : 80 K  
 Design : B

Rev.	Changes Summary	Performed	Checked	Date
Performed by				Page 35 / 36
Checked by				
Date	13/04/2022			

# VFD OPERATION CURVE

Three Phase Induction Motor - Squirrel Cage



Customer :

Product line : NEMA Premium Efficiency Three-Phase

Product code : 12598765

Catalog # : 01512ET3E284JM-W22

VFD OPERATION CURVE

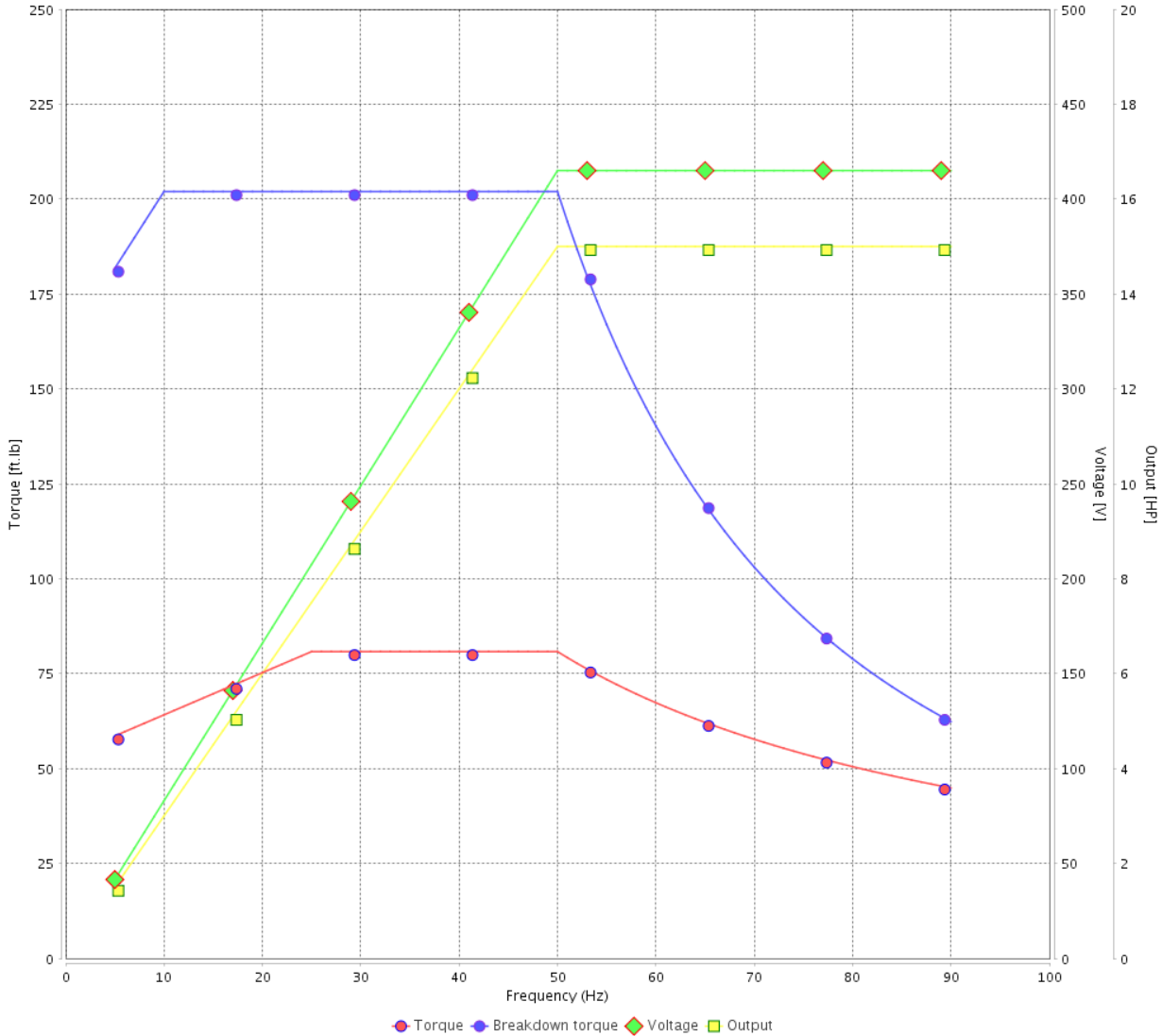

Performance : 415 V 50 Hz 6P IE2

Rated current	: 20.2 A	Moment of inertia (J)	: 7.85 sq.ft.lb
LRC	: 5.7	Duty cycle	: Cont.(S1)
Rated torque	: 80.8 ft.lb	Insulation class	: F
Locked rotor torque	: 220 %	Service factor	: 1.15
Breakdown torque	: 250 %	Temperature rise	: 80 K
Rated speed	: 975 rpm	Design	: B

Rev.	Changes Summary	Performed	Checked	Date
Performed by			Page 36 / 36	Revision
Checked by				
Date	13/04/2022			

1 2 3 4 5 6

A

B

C

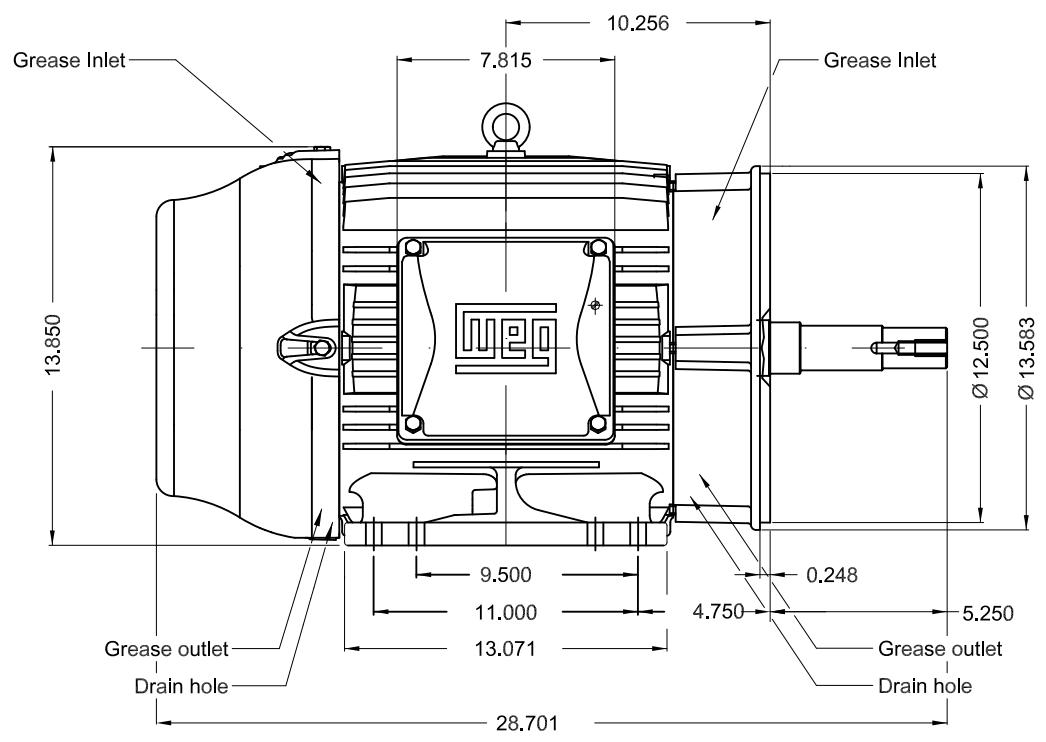
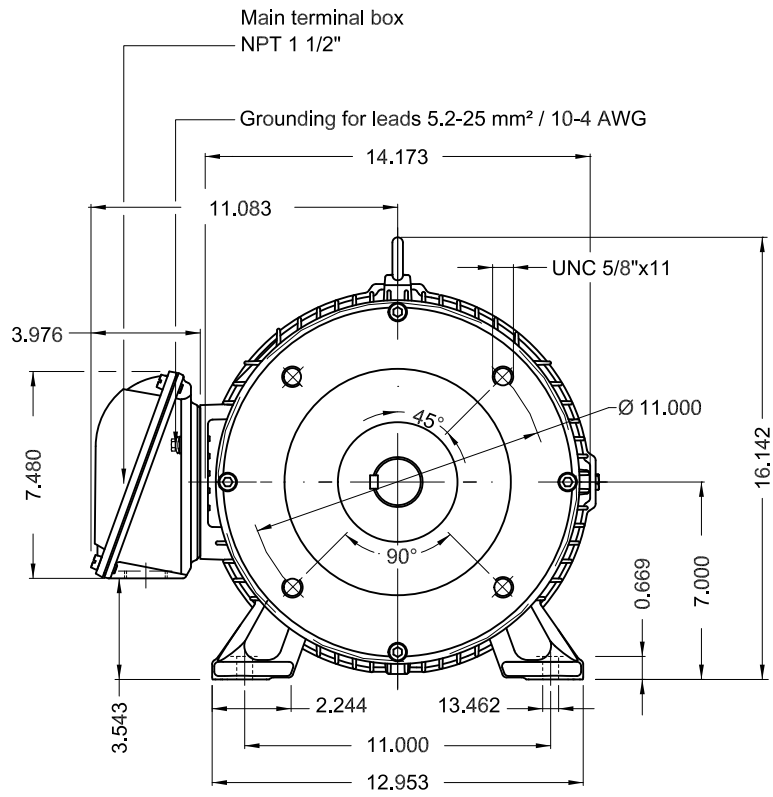

D

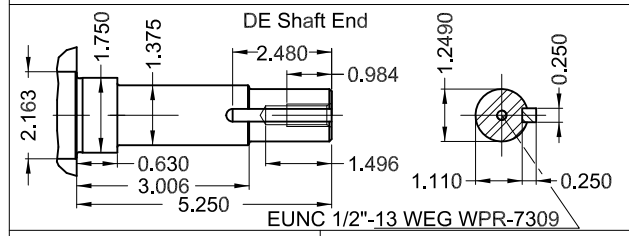

E

Color RAL 5009  
 Painting plan 203A  
 Mounting NEMA F-1  
 Mounting B34R(D)

15 HP 06 Poles 60 Hz A

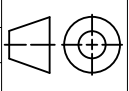
ECM	LOC	SUMMARY OF MODIFICATIONS	EXECUTED	CHECKED	RELEASED	DATE	VER
EXECUTED	PIRWBUSER	 THREE PH. MOTOR JM/JP/JET PUMP W22 PREM. EFF. FRAME 284/6JM IP55 TEFC					
CHECKED							
RELEASED							
REL DT.	WMO		Jaragua do Sul	Product Engineering	SHEET	1 / 1	

**PREVIEW**  
 WDD



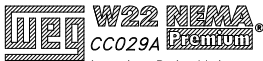

FOR SAFE AREA  
MOD.TE1BFOXON



For 60Hz: Class I, Div 2, Gr. A, B, C and D - T3  
Class I, Zone 2, IIC - T3  
Class II, Div 2, Gr. F and G - T4  
For 60Hz use on PWM, Gr. A, B, C, D and F,  
VT 1000:1, CT 20:1, 1.0SF, T3A

MODEL 01512ET3E284JM-W22  
MADE IN BRAZIL  
12598765

PH 3	FR 284/6JM	HP(kW) 15.0(11.0)	Hz 60
V 230/460	A 35.8/17.9	RPM 1175	DES B
NEMA NOM EFF 91.7 %	INS. CL. F ΔT 80 K	IP55	
ENCL TEFC	DUTY CONT.	AMB. 40°C	
CODE G	PF 0.84	SF 1.25	SFA 44.8/22.4
USABLE @208V 39.6 A	SF 1.15	SFA 45.5	
15HP 11kW 50Hz 380V 22.0A 965RPM SF1.00 EFF 88.5% (IE1)	ALT 1000 m.a.s.l.	425 Lbs	

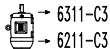
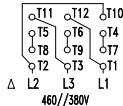
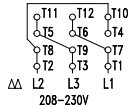

MOBIL POLYREX EM  
18 g 20000 h