

# DATA SHEET

## Three Phase Induction Motor - Squirrel Cage



Customer :					
Product line	: W40 NEMA Premium Efficiency Three-Phase	Product code :	14494126		
		Catalog # :	015120T3E284T-W40		
Frame	: 284T	Cooling method	: IC01 - ODP		
Insulation class	: F	Mounting	: F-1		
Duty cycle	: Cont.(S1)	Rotation <sup>1</sup>	: Both (CW and CCW)		
Ambient temperature	: -20°C to +40°C	Starting method	: Direct On Line		
Altitude	: 1000 m.a.s.l.	Approx. weight <sup>2</sup>	: 316 lb		
Protection degree	: IP23	Moment of inertia (J)	: 4.80 sq.ft.lb		
Design	: B				
Output [HP]	15	10	10	10	
Poles	6	6	6	6	
Frequency [Hz]	60	50	50	50	
Rated voltage [V]	230/460	380	400	415	
Rated current [A]	36.8/18.4	15.8	15.4	15.4	
L. R. Amperes [A]	232/116	115	116	122	
LRC [A]	6.3x(Code G)	7.3x(Code J)	7.5x(Code K)	7.9x(Code K)	
No load current [A]	15.6/7.80	7.80	8.40	8.90	
Rated speed [RPM]	1180	980	985	985	
Slip [%]	1.67	2.00	1.50	1.50	
Rated torque [ft.lb]	66.8	53.6	53.3	53.3	
Locked rotor torque [%]	260	290	330	360	
Breakdown torque [%]	260	320	350	380	
Service factor	1.25	1.00	1.00	1.00	
Temperature rise	80 K	80 K	80 K	80 K	
Locked rotor time	28s (cold) 16s (hot)	32s (cold) 18s (hot)	32s (cold) 18s (hot)	28s (cold) 16s (hot)	
Noise level <sup>2</sup>	59.0 dB(A)				
Efficiency (%)	25%	90.8	88.3	88.4	88.4
	50%	91.0	88.6	88.6	88.6
	75%	91.7	89.0	89.0	89.0
	100%	91.7	89.1	89.1	89.1
Power Factor	25%	0.42	0.37	0.33	0.31
	50%	0.67	0.62	0.58	0.55
	75%	0.77	0.75	0.71	0.68
	100%	0.82	0.81	0.79	0.76
Bearing type	: <u>Drive end</u> 6311 Z C3 <u>Non drive end</u> 6211 Z C3	Foundation loads			
Sealing	: Without Without	Max. traction			
	: Bearing Seal Bearing Seal	Max. compression			
Lubrication interval	: 20000 h 20000 h				
Lubricant amount	: 18 g 11 g				
Lubricant type	: Mobil Polyrex EM				
Notes USABLE @208V 40.7A SF 1.15 SFA 46.8A					
This revision replaces and cancel the previous one, which must be eliminated. (1) Looking the motor from the shaft end. (2) Measured at 1m and with tolerance of +3dB(A). (3) Approximate weight subject to changes after manufacturing process. (4) At 100% of full load.			These are average values based on tests with sinusoidal power supply, subject to the tolerances stipulated in NEMA MG-1.		
Rev.	Changes Summary		Performed	Checked	Date
Performed by					
Checked by				Page	Revision
Date	13/04/2022			1 / 21	

# TORQUE AND CURRENT VS SPEED CURVE

Three Phase Induction Motor - Squirrel Cage



Customer :

Product line : W40 NEMA Premium Efficiency  
Three-Phase

Product code : 14494126

Catalog # : 015120T3E284T-W40

TORQUE AND CURRENT VS SPEED CURVE

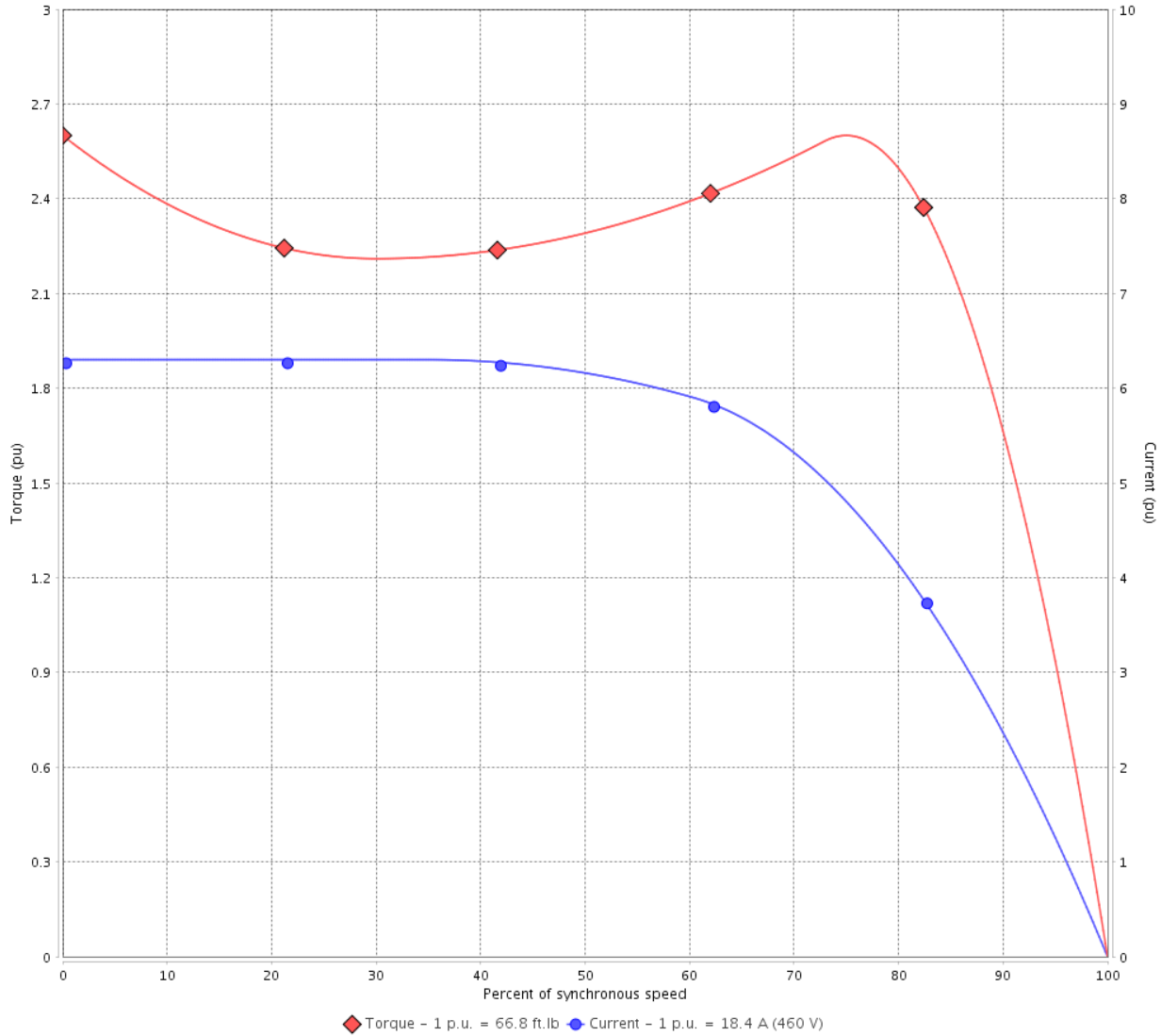

Performance : 230/460 V 60 Hz 6P

Rated current	: 36.8/18.4 A	Moment of inertia (J)	: 4.80 sq.ft.lb
LRC	: 6.3	Duty cycle	: Cont.(S1)
Rated torque	: 66.8 ft.lb	Insulation class	: F
Locked rotor torque	: 260 %	Service factor	: 1.25
Breakdown torque	: 260 %	Temperature rise	: 80 K
Rated speed	: 1180 rpm	Design	: B

Locked rotor time : 28s (cold) 16s (hot)

Rev.	Changes Summary	Performed	Checked	Date
Performed by			Page 2 / 21	Revision
Checked by				
Date	13/04/2022			

# TORQUE AND CURRENT VS SPEED CURVE



## Three Phase Induction Motor - Squirrel Cage

Customer :

Product line : W40 NEMA Premium Efficiency  
Three-Phase

Product code : 14494126

Catalog # : 015120T3E284T-W40

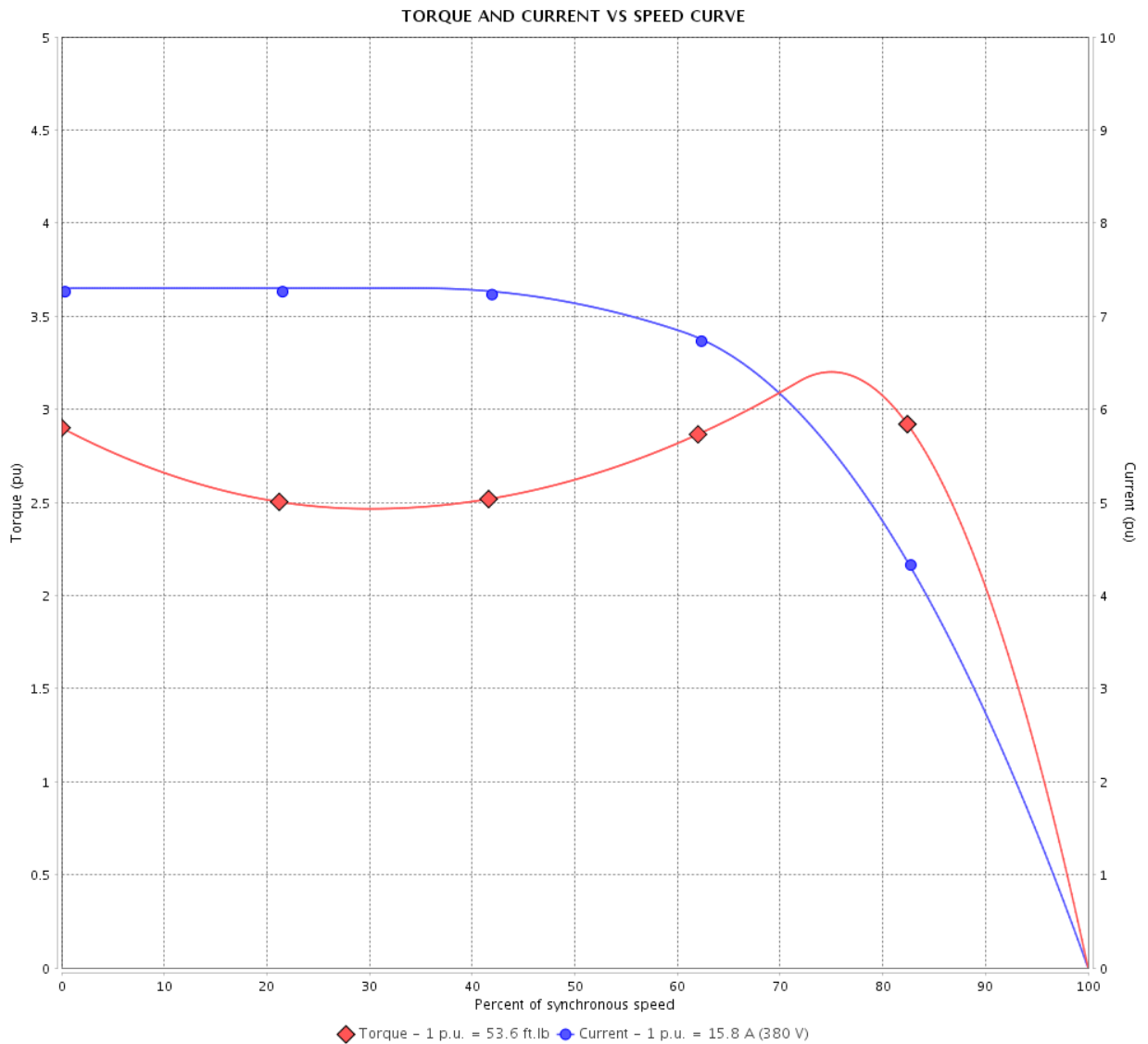

Performance : 380 V 50 Hz 6P IE3

Rated current	: 15.8 A	Moment of inertia (J)	: 4.80 sq.ft.lb
LRC	: 7.3	Duty cycle	: Cont.(S1)
Rated torque	: 53.6 ft.lb	Insulation class	: F
Locked rotor torque	: 290 %	Service factor	: 1.00
Breakdown torque	: 320 %	Temperature rise	: 80 K
Rated speed	: 980 rpm	Design	: B

Locked rotor time : 32s (cold) 18s (hot)

Rev.	Changes Summary	Performed	Checked	Date
Performed by			Page 3 / 21	Revision
Checked by				
Date	13/04/2022			

# TORQUE AND CURRENT VS SPEED CURVE

Three Phase Induction Motor - Squirrel Cage



Customer :

Product line : W40 NEMA Premium Efficiency  
Three-Phase

Product code : 14494126

Catalog # : 015120T3E284T-W40

TORQUE AND CURRENT VS SPEED CURVE

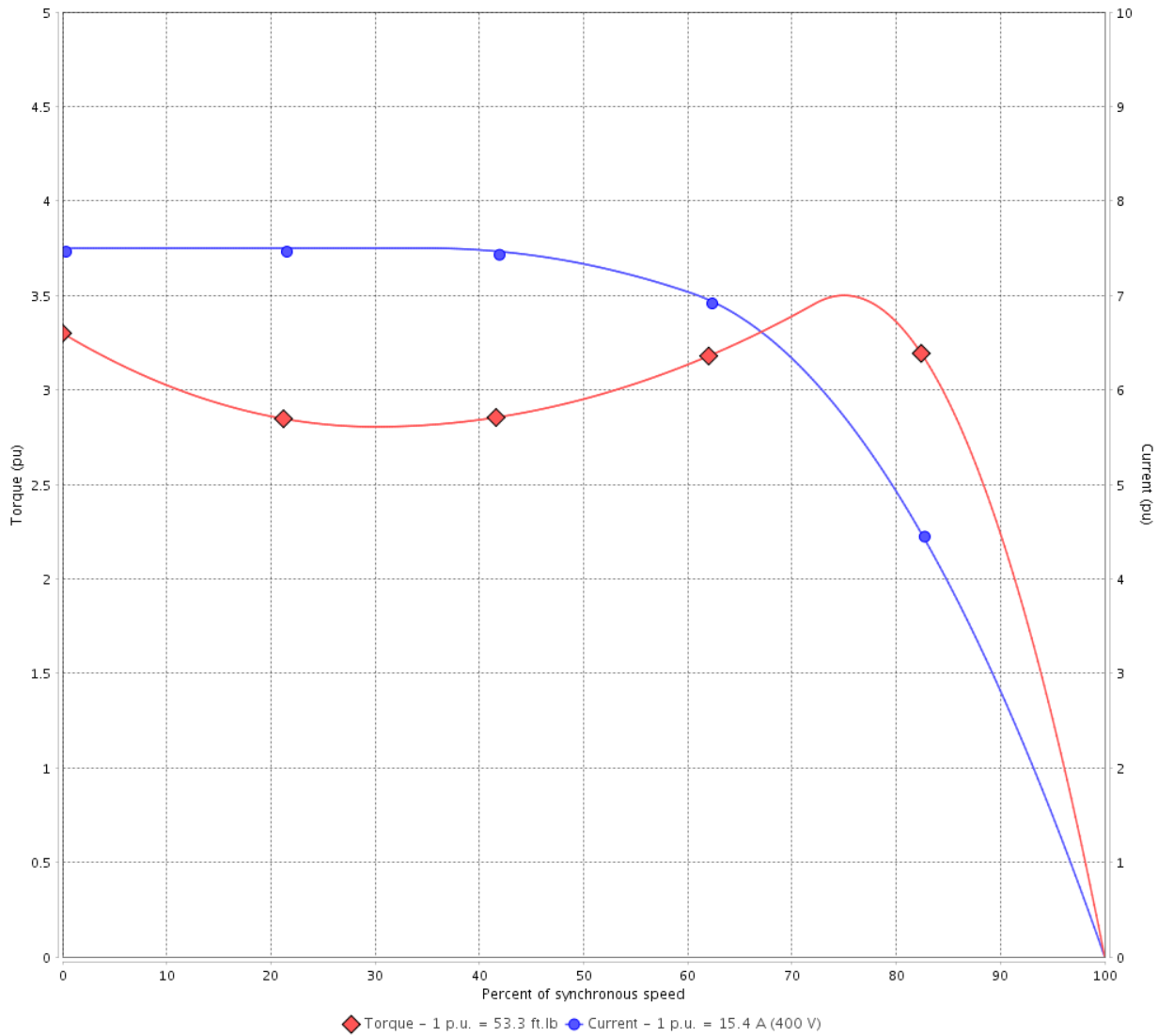

Performance : 400 V 50 Hz 6P IE3

Rated current	: 15.4 A	Moment of inertia (J)	: 4.80 sq.ft.lb
LRC	: 7.5	Duty cycle	: Cont.(S1)
Rated torque	: 53.3 ft.lb	Insulation class	: F
Locked rotor torque	: 330 %	Service factor	: 1.00
Breakdown torque	: 350 %	Temperature rise	: 80 K
Rated speed	: 985 rpm	Design	: B

Locked rotor time : 32s (cold) 18s (hot)

Rev.	Changes Summary	Performed	Checked	Date
Performed by			Page 4 / 21	Revision
Checked by				
Date	13/04/2022			

# TORQUE AND CURRENT VS SPEED CURVE



## Three Phase Induction Motor - Squirrel Cage

Customer :

Product line : W40 NEMA Premium Efficiency  
Three-Phase

Product code : 14494126

Catalog # : 01512OT3E284T-W40

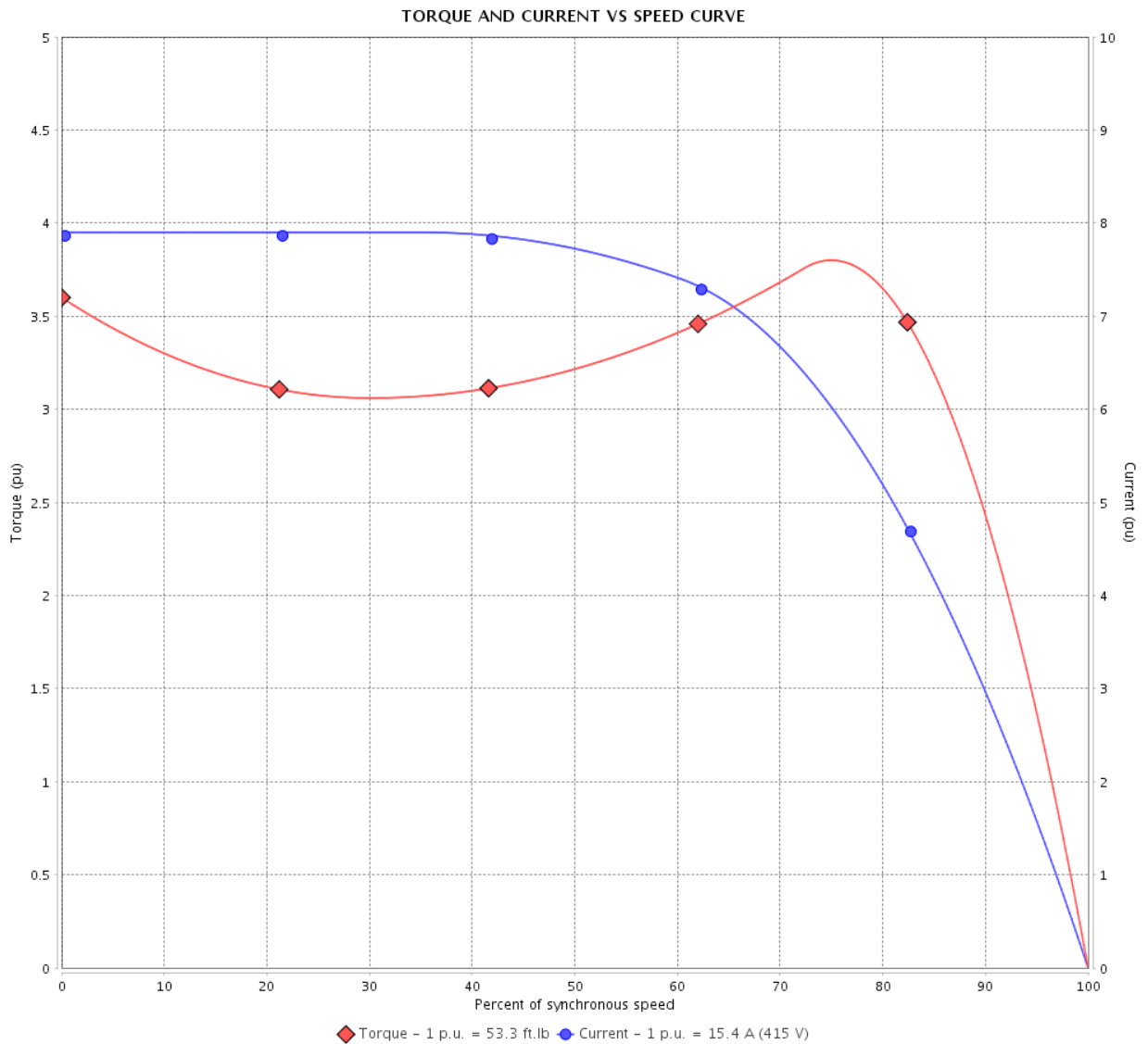

Performance : 415 V 50 Hz 6P IE3

Rated current	: 15.4 A	Moment of inertia (J)	: 4.80 sq.ft.lb
LRC	: 7.9	Duty cycle	: Cont.(S1)
Rated torque	: 53.3 ft.lb	Insulation class	: F
Locked rotor torque	: 360 %	Service factor	: 1.00
Breakdown torque	: 380 %	Temperature rise	: 80 K
Rated speed	: 985 rpm	Design	: B

Locked rotor time : 28s (cold) 16s (hot)

Rev.	Changes Summary	Performed	Checked	Date
Performed by			Page 5 / 21	Revision
Checked by				
Date	13/04/2022			

# LOAD PERFORMANCE CURVE

Three Phase Induction Motor - Squirrel Cage



Customer :

Product line : W40 NEMA Premium Efficiency Three-Phase

Product code : 14494126

Catalog # : 015120T3E284T-W40

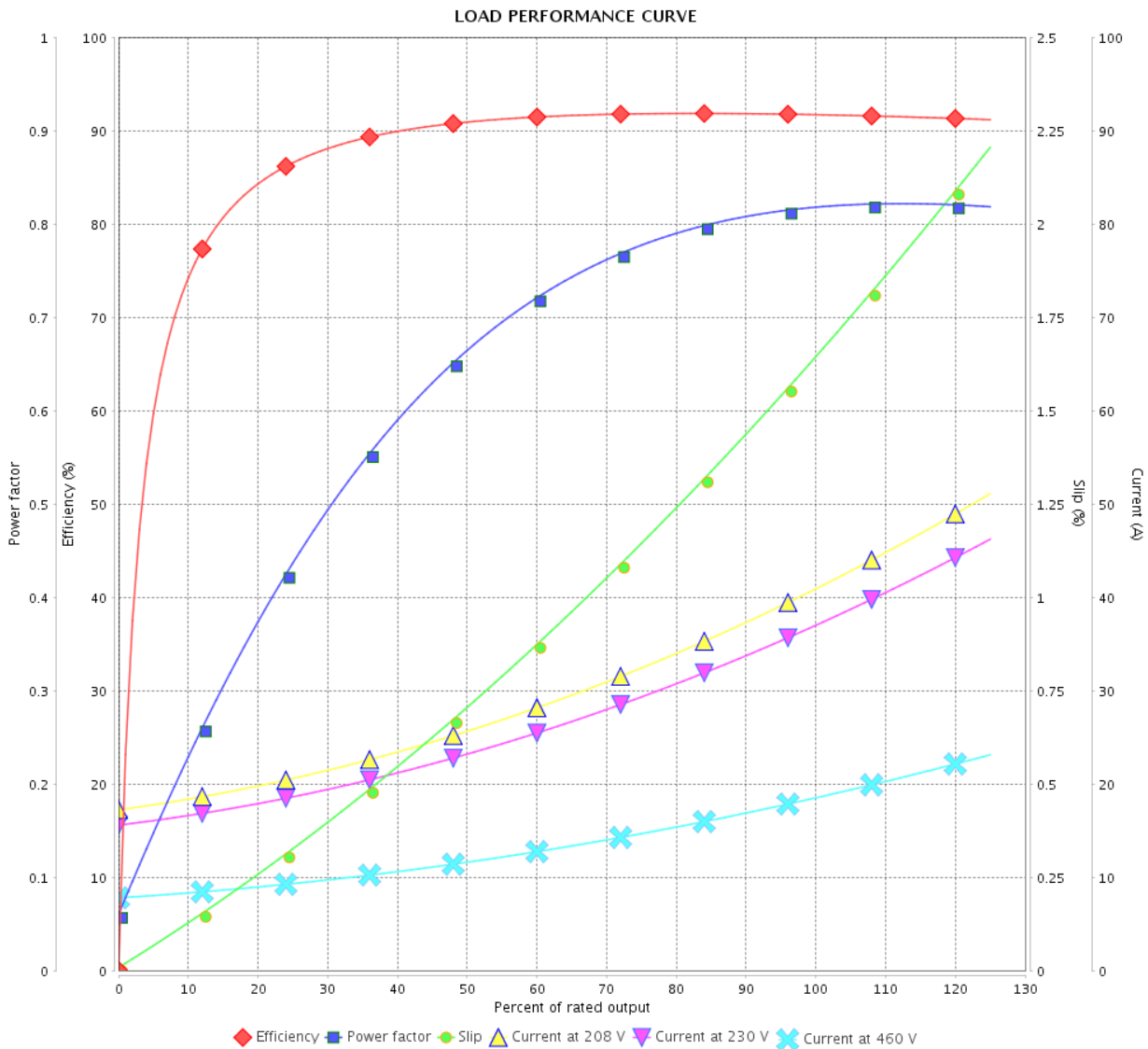

Performance : 230/460 V 60 Hz 6P

Rated current : 36.8/18.4 A  
 LRC : 6.3  
 Rated torque : 66.8 ft.lb  
 Locked rotor torque : 260 %  
 Breakdown torque : 260 %  
 Rated speed : 1180 rpm

Moment of inertia (J) : 4.80 sq.ft.lb  
 Duty cycle : Cont.(S1)  
 Insulation class : F  
 Service factor : 1.25  
 Temperature rise : 80 K  
 Design : B

Rev.	Changes Summary	Performed	Checked	Date
Performed by			Page 6 / 21	Revision
Checked by				
Date	13/04/2022			



# LOAD PERFORMANCE CURVE

Three Phase Induction Motor - Squirrel Cage



Customer :

Product line : W40 NEMA Premium Efficiency  
Three-Phase

Product code : 14494126

Catalog # : 015120T3E284T-W40

LOAD PERFORMANCE CURVE

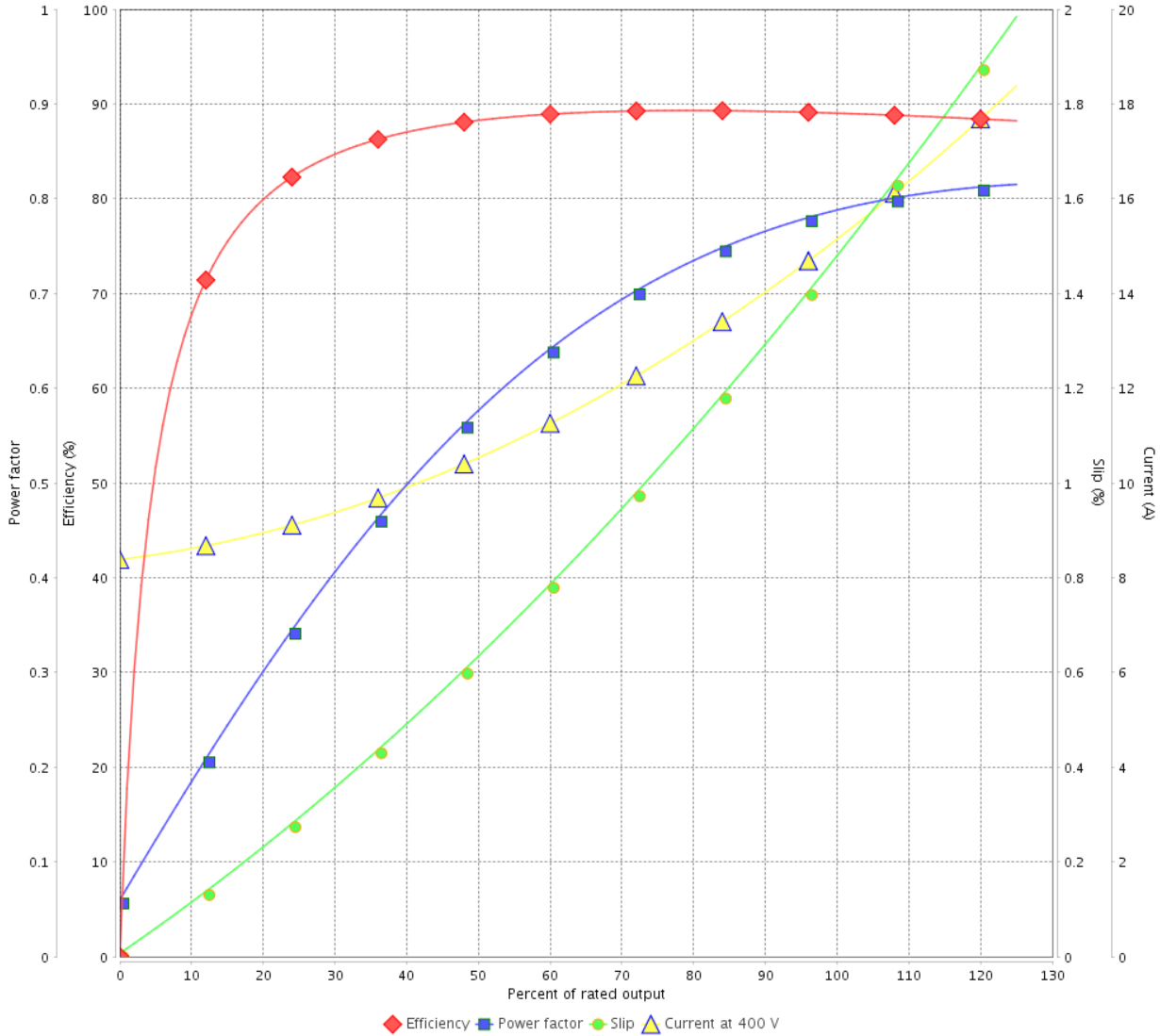

Performance : 400 V 50 Hz 6P IE3

Rated current : 15.4 A  
LRC : 7.5  
Rated torque : 53.3 ft.lb  
Locked rotor torque : 330 %  
Breakdown torque : 350 %  
Rated speed : 985 rpm

Moment of inertia (J) : 4.80 sq.ft.lb  
Duty cycle : Cont.(S1)  
Insulation class : F  
Service factor : 1.00  
Temperature rise : 80 K  
Design : B

Rev.	Changes Summary	Performed	Checked	Date
Performed by			Page	Revision
Checked by				
Date	13/04/2022			



# LOAD PERFORMANCE CURVE

## Three Phase Induction Motor - Squirrel Cage



Customer : \_\_\_\_\_

Product line : W40 NEMA Premium Efficiency  
Three-Phase

Product code : 14494126

Catalog # : 015120T3E284T-W40

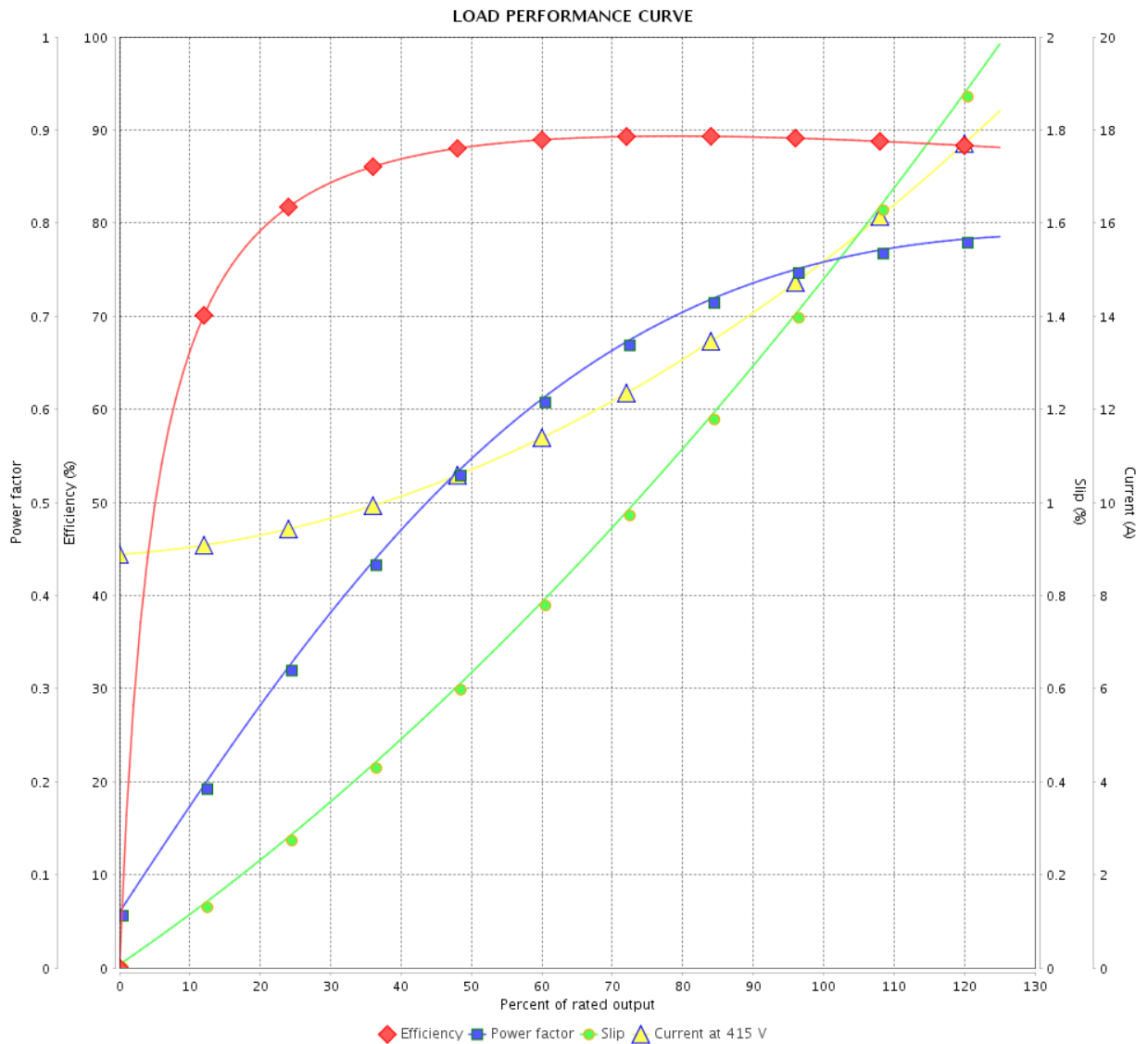

Performance : 415 V 50 Hz 6P IE3

Rated current : 15.4 A  
 LRC : 7.9  
 Rated torque : 53.3 ft.lb  
 Locked rotor torque : 360 %  
 Breakdown torque : 380 %  
 Rated speed : 985 rpm

Moment of inertia (J) : 4.80 sq.ft.lb  
 Duty cycle : Cont.(S1)  
 Insulation class : F  
 Service factor : 1.00  
 Temperature rise : 80 K  
 Design : B

Rev.	Changes Summary	Performed	Checked	Date
Performed by			Page	Revision
Checked by				
Date				

# THERMAL LIMIT CURVE



## Three Phase Induction Motor - Squirrel Cage

Customer :

Product line : W40 NEMA Premium Efficiency  
Three-Phase

Product code : 14494126

Catalog # : 01512OT3E284T-W40

Performance : 230/460 V 60 Hz 6P

Rated current : 36.8/18.4 A  
LRC : 6.3  
Rated torque : 66.8 ft.lb  
Locked rotor torque : 260 %  
Breakdown torque : 260 %  
Rated speed : 1180 rpm

Moment of inertia (J) : 4.80 sq.ft.lb  
Duty cycle : Cont.(S1)  
Insulation class : F  
Service factor : 1.25  
Temperature rise : 80 K  
Design : B

Heating constant

Cooling constant

Rev.	Changes Summary	Performed	Checked	Date
Performed by				
Checked by			Page	Revision
Date	13/04/2022		10 / 21	

# THERMAL LIMIT CURVE

Three Phase Induction Motor - Squirrel Cage



Customer : \_\_\_\_\_

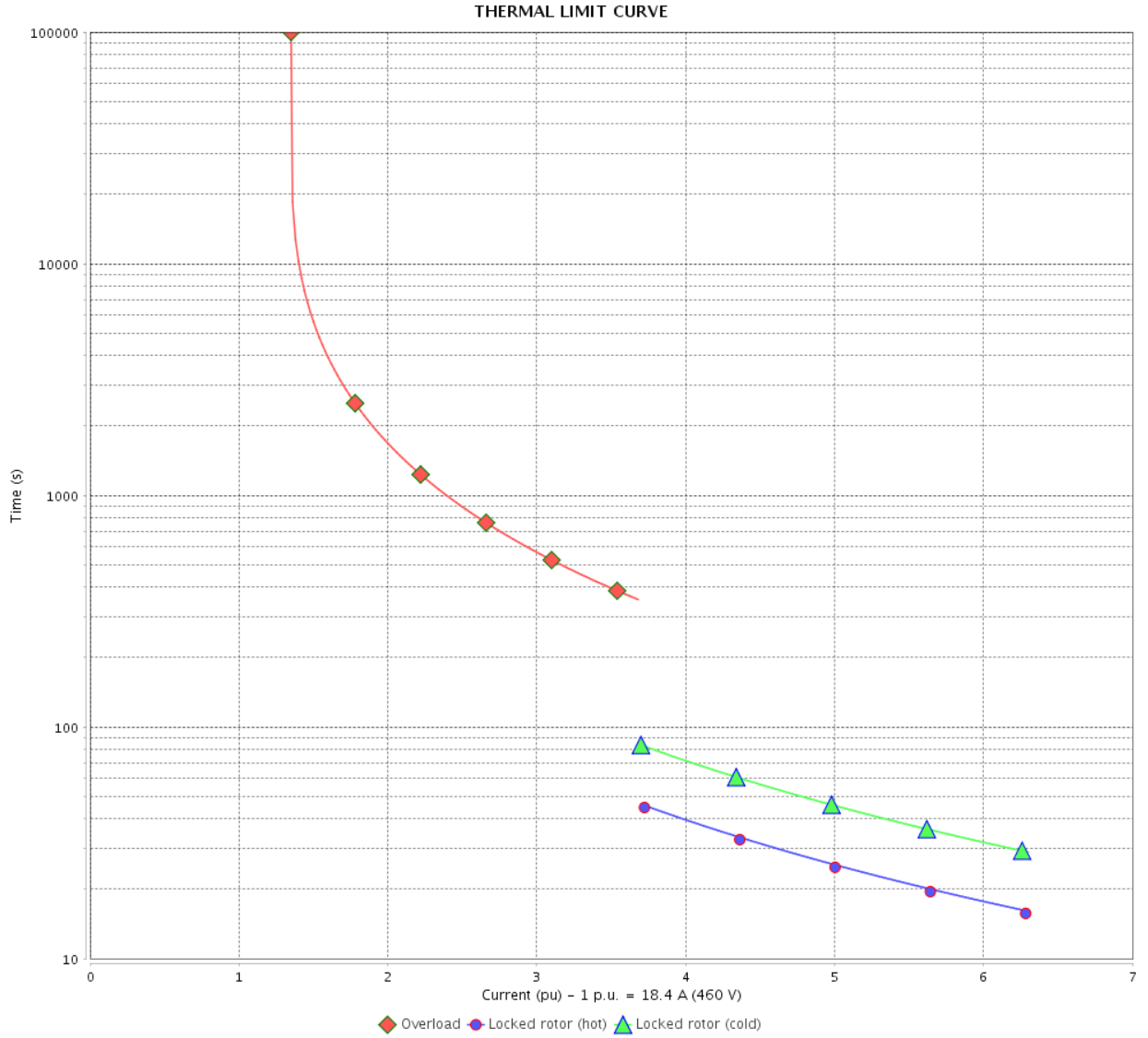

Rev.	Changes Summary	Performed	Checked	Date
Performed by		Page		Revision
Checked by		11 / 21		
Date		13/04/2022		

# THERMAL LIMIT CURVE



## Three Phase Induction Motor - Squirrel Cage

Customer :

Product line : W40 NEMA Premium Efficiency  
Three-Phase

Product code : 14494126

Catalog # : 015120T3E284T-W40

Performance : 380 V 50 Hz 6P IE3

Rated current	: 15.8 A	Moment of inertia (J)	: 4.80 sq.ft.lb
LRC	: 7.3	Duty cycle	: Cont.(S1)
Rated torque	: 53.6 ft.lb	Insulation class	: F
Locked rotor torque	: 290 %	Service factor	: 1.00
Breakdown torque	: 320 %	Temperature rise	: 80 K
Rated speed	: 980 rpm	Design	: B

Heating constant

Cooling constant

Rev.	Changes Summary	Performed	Checked	Date
Performed by				
Checked by			Page	Revision
Date	13/04/2022		12 / 21	

# THERMAL LIMIT CURVE

Three Phase Induction Motor - Squirrel Cage



Customer : \_\_\_\_\_

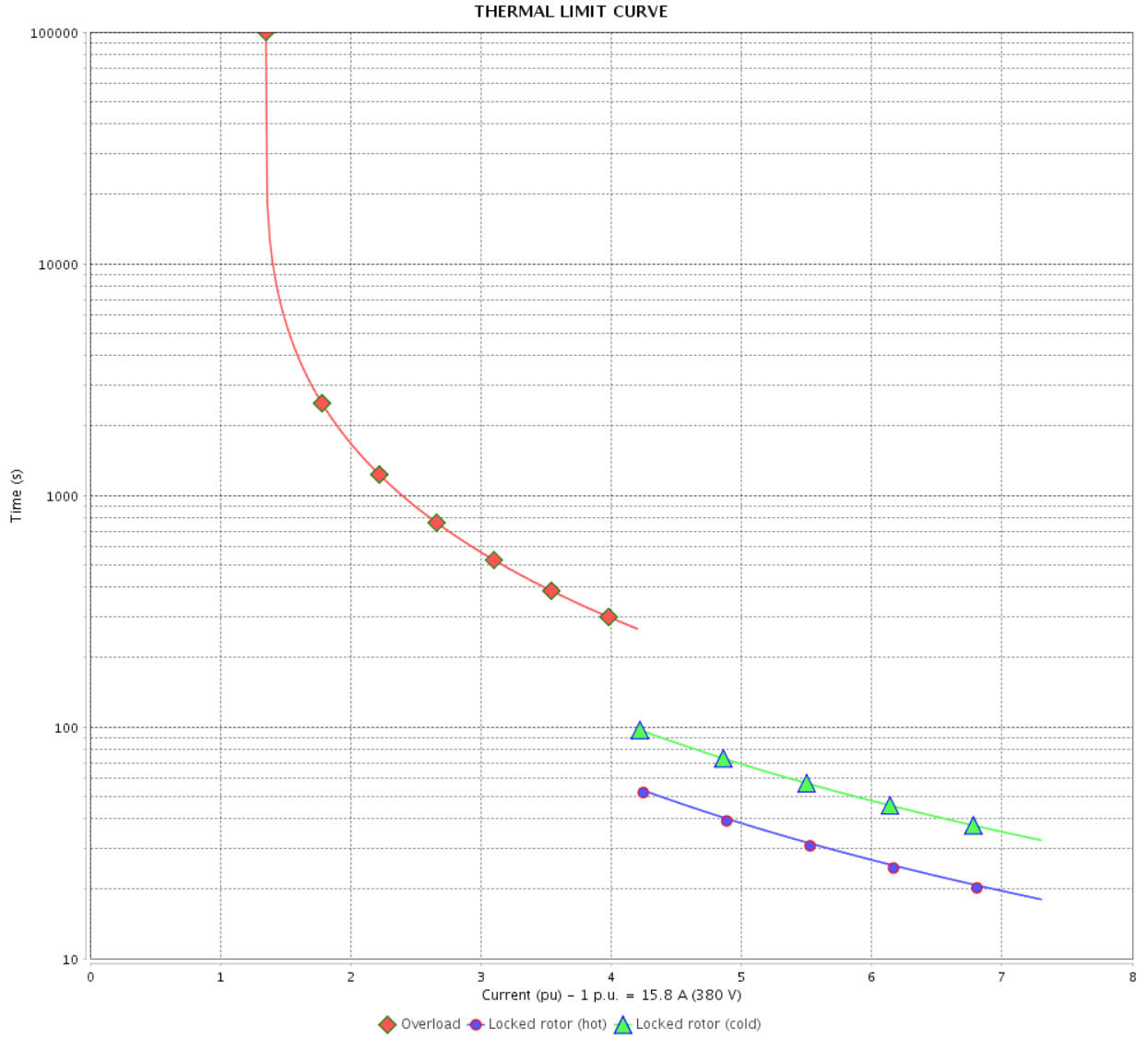

Rev.	Changes Summary	Performed	Checked	Date
Performed by				
Checked by				
Date				
		Page	Revision	
		13 / 21		

# THERMAL LIMIT CURVE



## Three Phase Induction Motor - Squirrel Cage

Customer :

Product line : W40 NEMA Premium Efficiency  
Three-Phase

Product code : 14494126

Catalog # : 015120T3E284T-W40

Performance : 400 V 50 Hz 6P IE3

Rated current	: 15.4 A	Moment of inertia (J)	: 4.80 sq.ft.lb
LRC	: 7.5	Duty cycle	: Cont.(S1)
Rated torque	: 53.3 ft.lb	Insulation class	: F
Locked rotor torque	: 330 %	Service factor	: 1.00
Breakdown torque	: 350 %	Temperature rise	: 80 K
Rated speed	: 985 rpm	Design	: B

Heating constant

Cooling constant

Rev.	Changes Summary	Performed	Checked	Date
Performed by				
Checked by			Page	Revision
Date	13/04/2022		14 / 21	

# THERMAL LIMIT CURVE

Three Phase Induction Motor - Squirrel Cage



Customer : \_\_\_\_\_

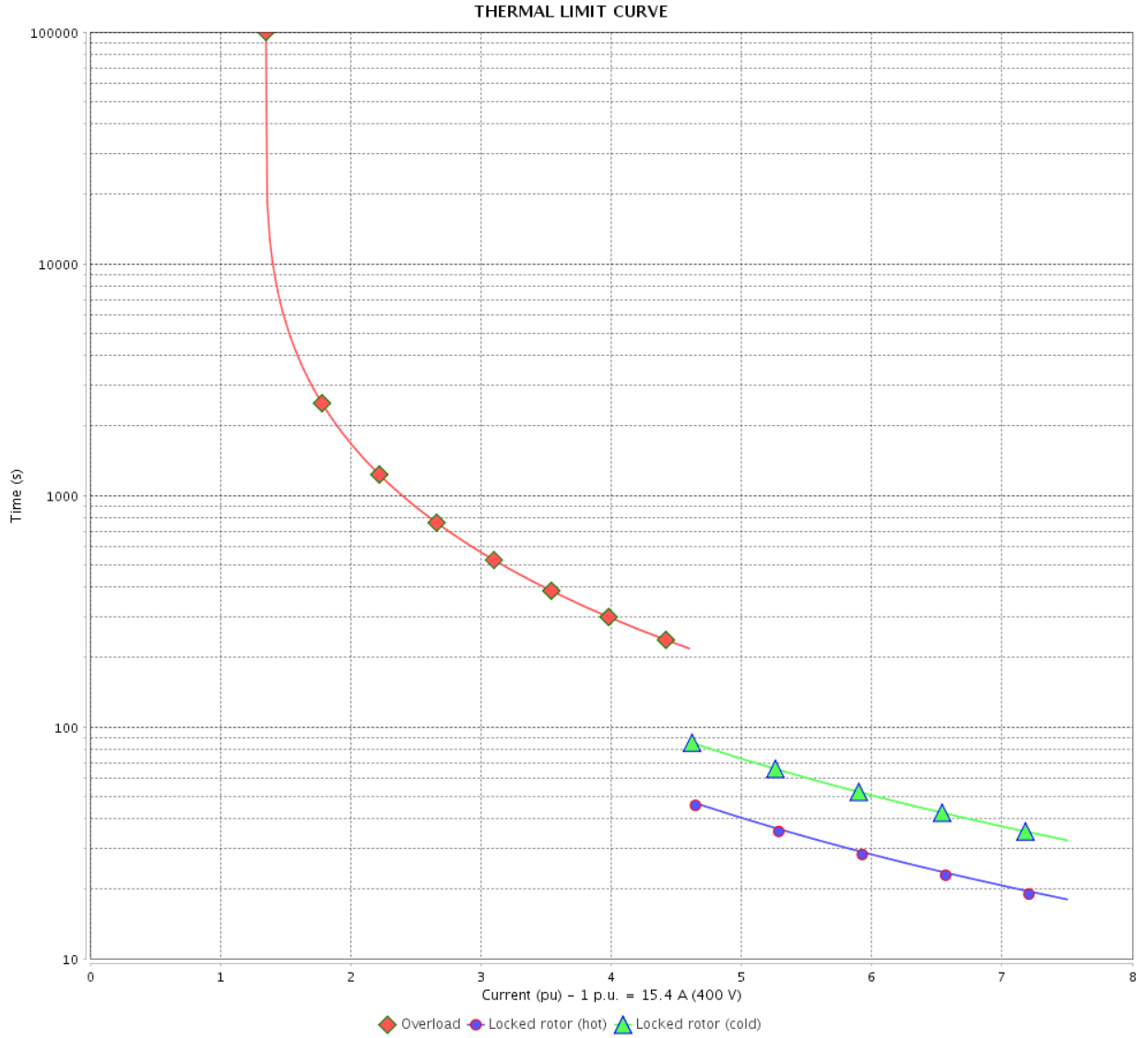

Rev.	Changes Summary	Performed	Checked	Date
Performed by		Page 15 / 21		Revision
Checked by				
Date				

# THERMAL LIMIT CURVE



## Three Phase Induction Motor - Squirrel Cage

Customer :

Product line : W40 NEMA Premium Efficiency  
Three-Phase

Product code : 14494126

Catalog # : 01512OT3E284T-W40

Performance : 415 V 50 Hz 6P IE3

Rated current	: 15.4 A	Moment of inertia (J)	: 4.80 sq.ft.lb
LRC	: 7.9	Duty cycle	: Cont.(S1)
Rated torque	: 53.3 ft.lb	Insulation class	: F
Locked rotor torque	: 360 %	Service factor	: 1.00
Breakdown torque	: 380 %	Temperature rise	: 80 K
Rated speed	: 985 rpm	Design	: B

Heating constant

Cooling constant

Rev.	Changes Summary	Performed	Checked	Date
Performed by				
Checked by			Page	Revision
Date	13/04/2022		16 / 21	



# THERMAL LIMIT CURVE

Three Phase Induction Motor - Squirrel Cage



Customer : \_\_\_\_\_

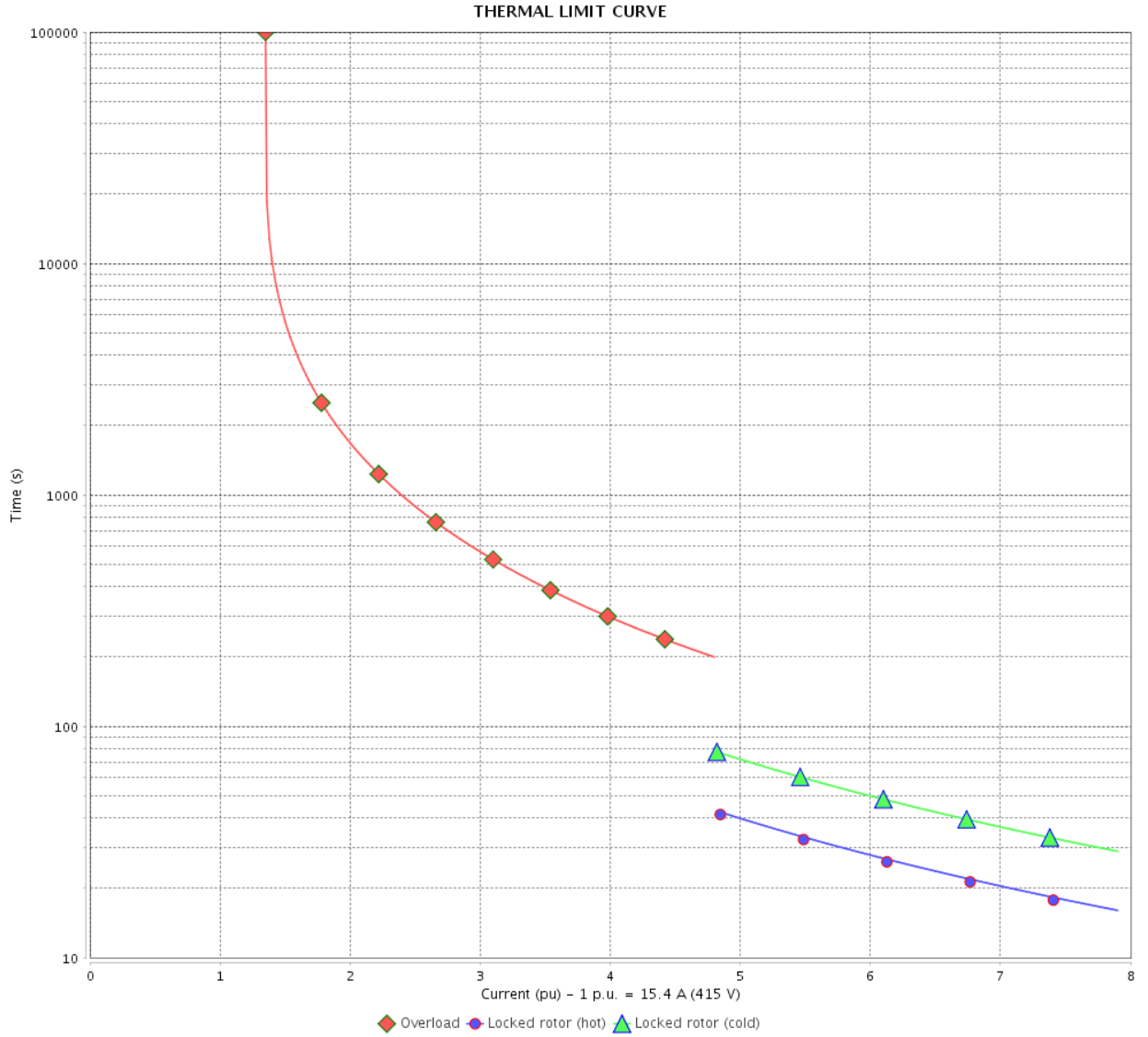

Rev.	Changes Summary	Performed	Checked	Date
Performed by				
Checked by				
Date				
		Page 17 / 21	Revision	

# VFD OPERATION CURVE

Three Phase Induction Motor - Squirrel Cage



Customer :

Product line : W40 NEMA Premium Efficiency Three-Phase

Product code : 14494126

Catalog # : 015120T3E284T-W40

VFD OPERATION CURVE

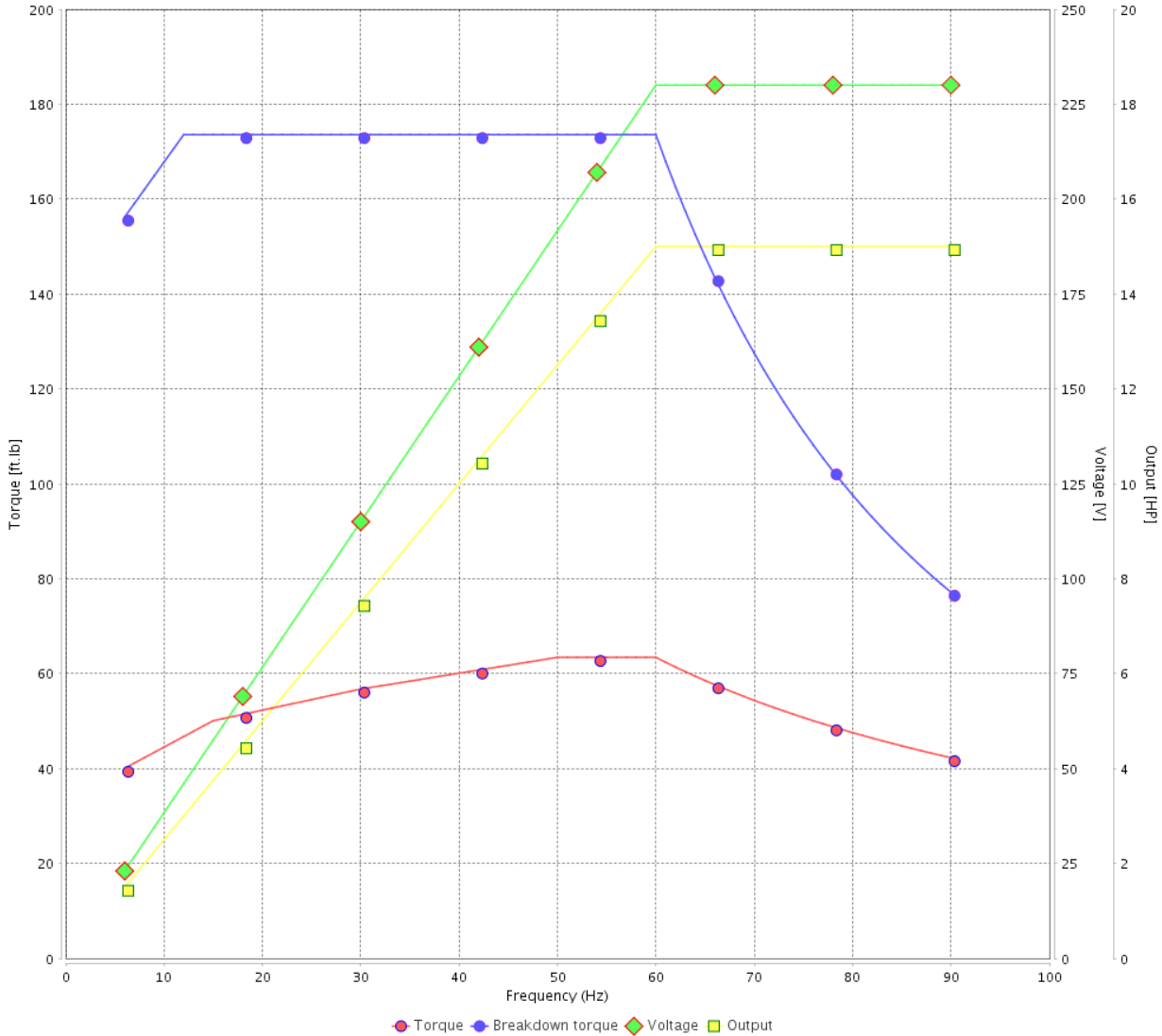

Performance : 230/460 V 60 Hz 6P

Rated current : 36.8/18.4 A  
 LRC : 6.3  
 Rated torque : 66.8 ft.lb  
 Locked rotor torque : 260 %  
 Breakdown torque : 260 %  
 Rated speed : 1180 rpm

Moment of inertia (J) : 4.80 sq.ft.lb  
 Duty cycle : Cont.(S1)  
 Insulation class : F  
 Service factor : 1.25  
 Temperature rise : 80 K  
 Design : B

Rev.	Changes Summary	Performed	Checked	Date
Performed by			Page 18 / 21	Revision
Checked by				
Date	13/04/2022			

# VFD OPERATION CURVE

Three Phase Induction Motor - Squirrel Cage



Customer :

Product line : W40 NEMA Premium Efficiency  
Three-Phase

Product code : 14494126

Catalog # : 01512OT3E284T-W40

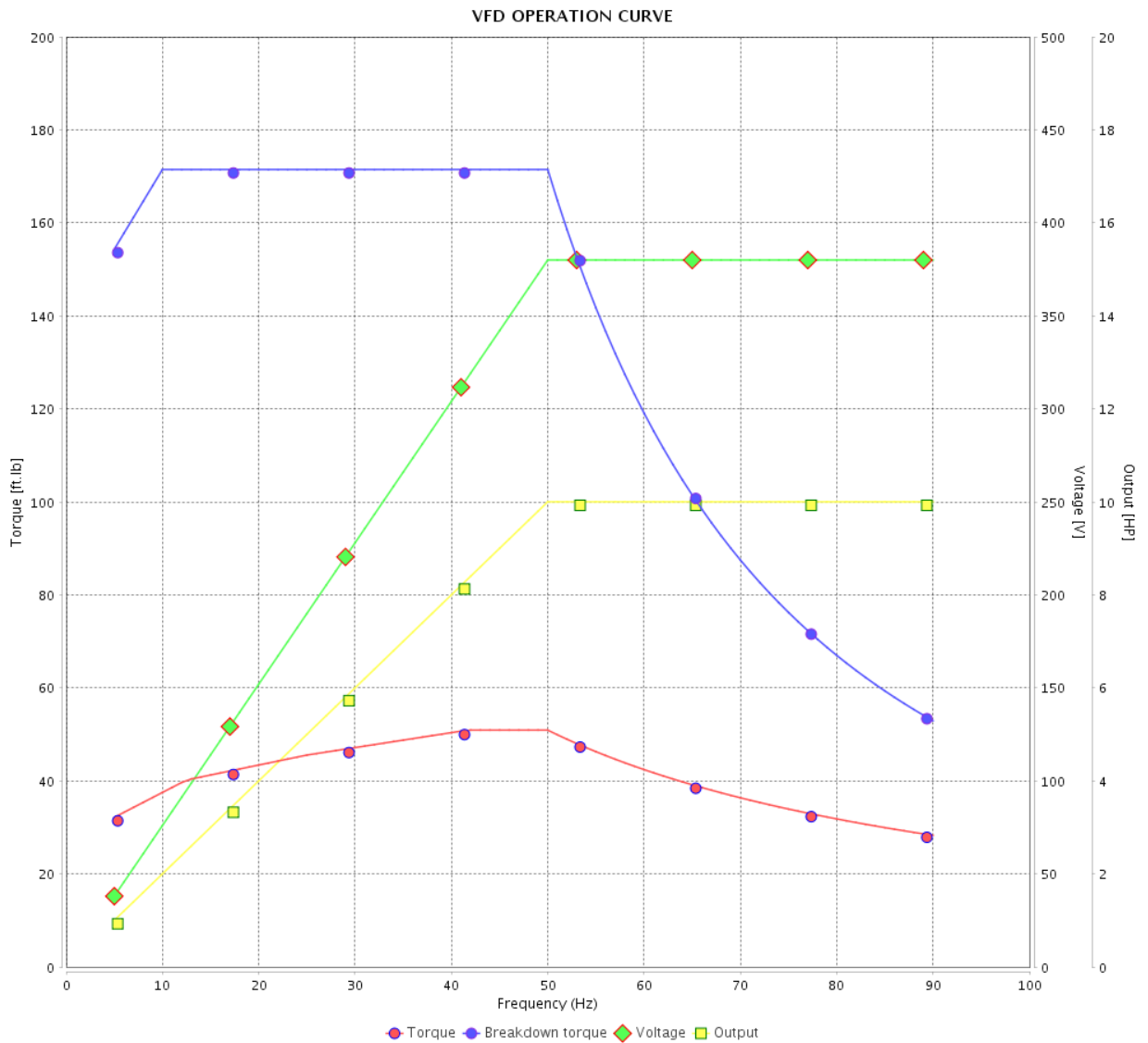

Performance : 380 V 50 Hz 6P IE3

Rated current : 15.8 A  
 LRC : 7.3  
 Rated torque : 53.6 ft.lb  
 Locked rotor torque : 290 %  
 Breakdown torque : 320 %  
 Rated speed : 980 rpm

Moment of inertia (J) : 4.80 sq.ft.lb  
 Duty cycle : Cont.(S1)  
 Insulation class : F  
 Service factor : 1.00  
 Temperature rise : 80 K  
 Design : B

Rev.	Changes Summary	Performed	Checked	Date
Performed by				Page 19 / 21
Checked by				
Date	13/04/2022			
				Revision

# VFD OPERATION CURVE

Three Phase Induction Motor - Squirrel Cage



Customer :

Product line : W40 NEMA Premium Efficiency Three-Phase

Product code : 14494126

Catalog # : 015120T3E284T-W40

VFD OPERATION CURVE

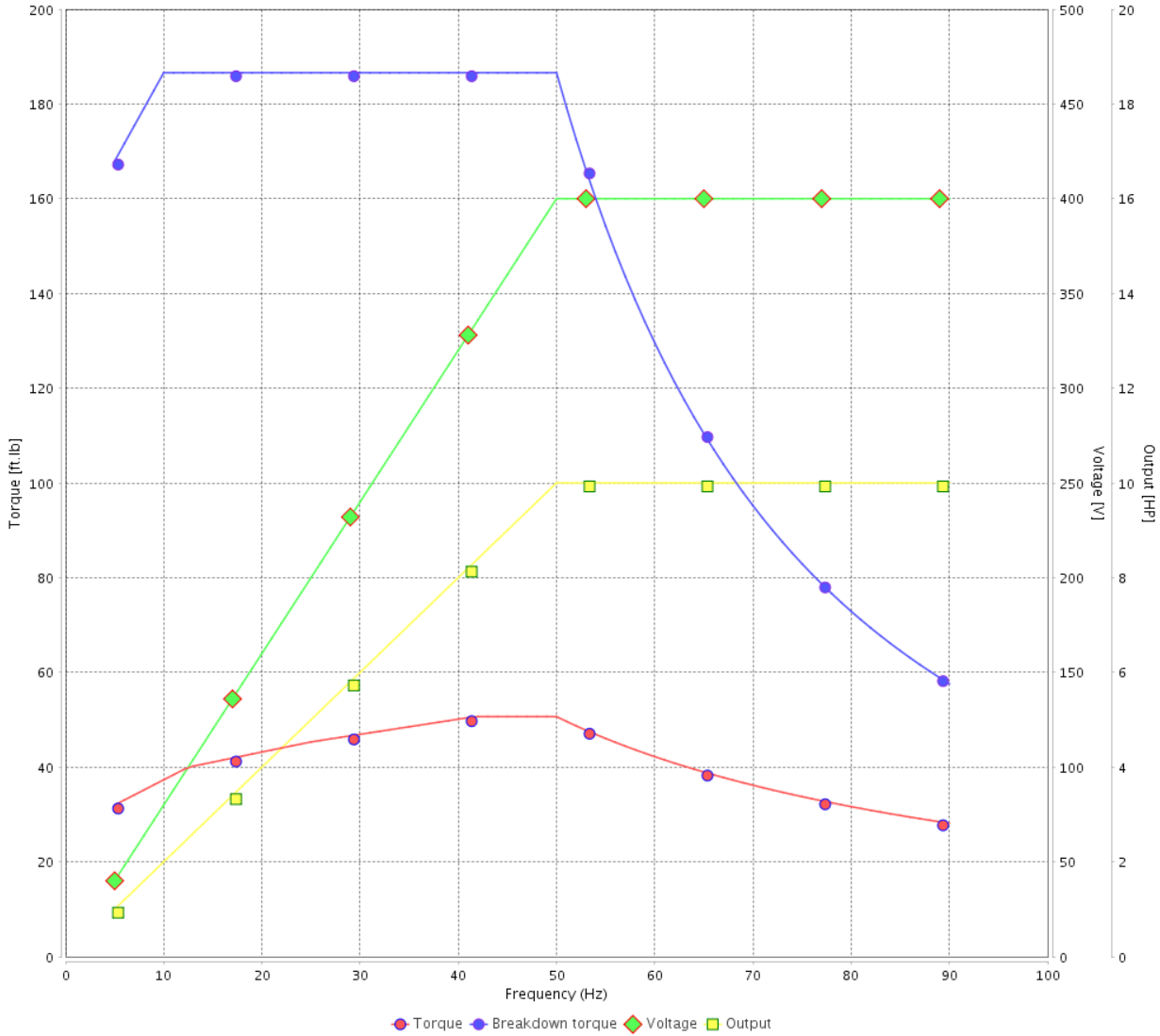

Performance : 400 V 50 Hz 6P IE3

Rated current : 15.4 A  
 LRC : 7.5  
 Rated torque : 53.3 ft.lb  
 Locked rotor torque : 330 %  
 Breakdown torque : 350 %  
 Rated speed : 985 rpm

Moment of inertia (J) : 4.80 sq.ft.lb  
 Duty cycle : Cont.(S1)  
 Insulation class : F  
 Service factor : 1.00  
 Temperature rise : 80 K  
 Design : B

Rev.	Changes Summary	Performed	Checked	Date
Performed by			Page	Revision
Checked by				
Date				

# VFD OPERATION CURVE

Three Phase Induction Motor - Squirrel Cage



Customer :

Product line : W40 NEMA Premium Efficiency Three-Phase

Product code : 14494126

Catalog # : 01512OT3E284T-W40

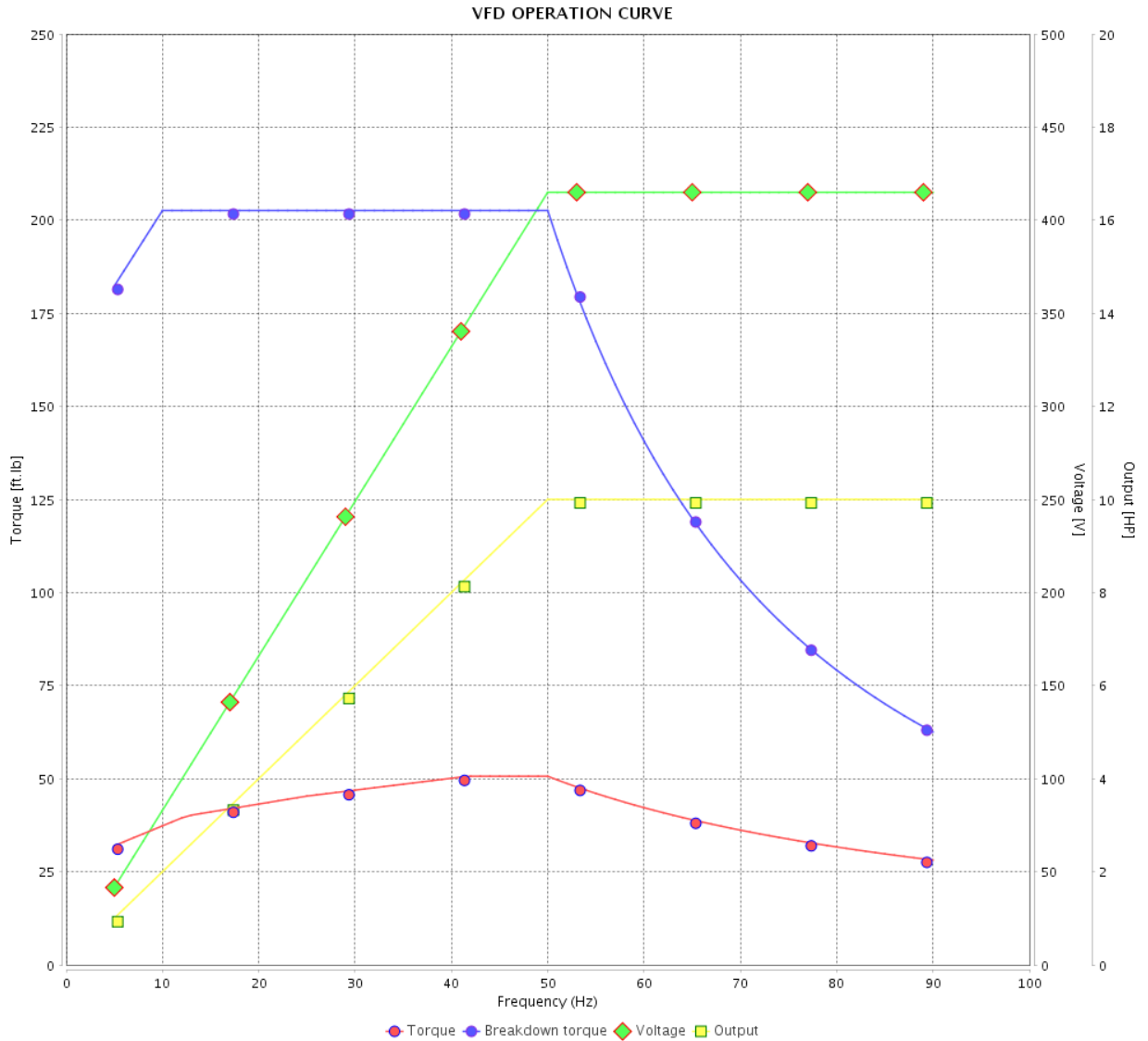

Performance : 415 V 50 Hz 6P IE3

Rated current : 15.4 A  
 LRC : 7.9  
 Rated torque : 53.3 ft.lb  
 Locked rotor torque : 360 %  
 Breakdown torque : 380 %  
 Rated speed : 985 rpm

Moment of inertia (J) : 4.80 sq.ft.lb  
 Duty cycle : Cont.(S1)  
 Insulation class : F  
 Service factor : 1.00  
 Temperature rise : 80 K  
 Design : B

Rev.	Changes Summary	Performed	Checked	Date
Performed by			Page 21 / 21	Revision
Checked by				
Date	13/04/2022			

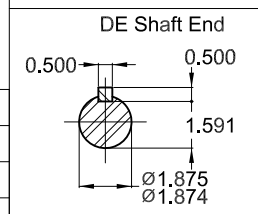
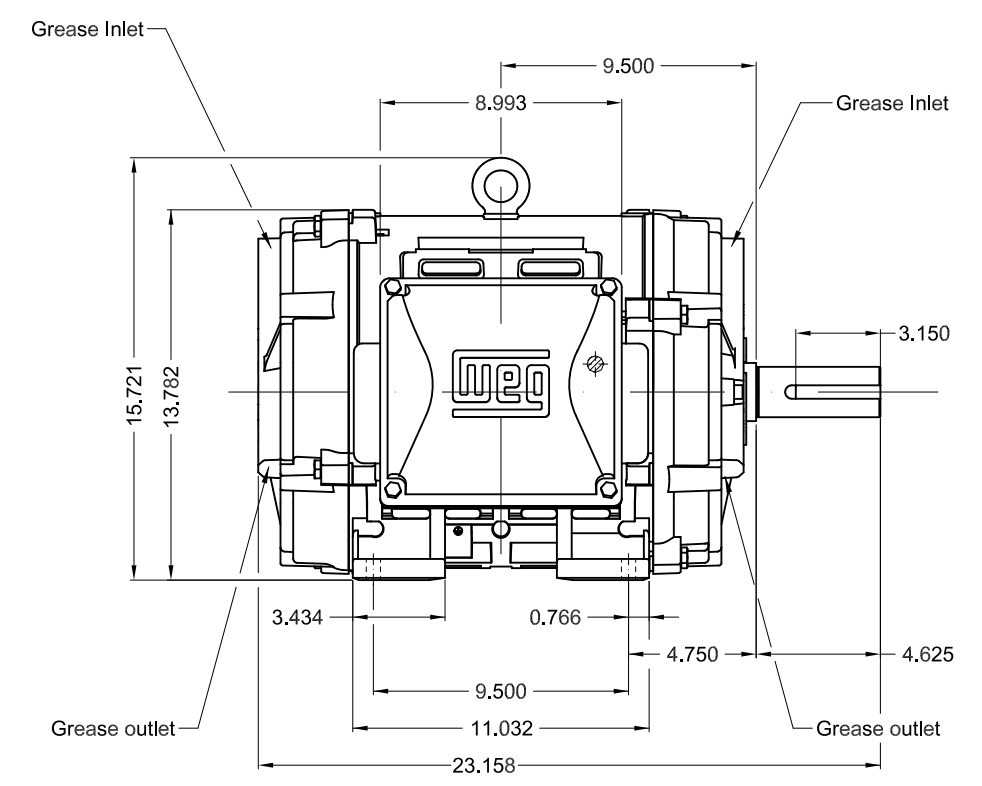
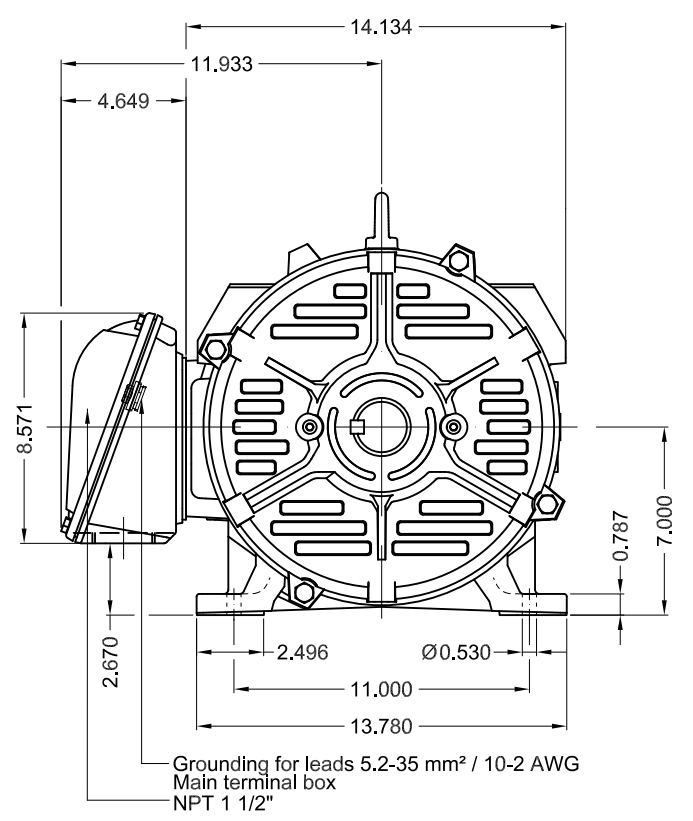

Color RAL 5009  
Painting plan 203A  
Mounting NEMA F-1  
Mounting B3R(D)

15 HP 06 Poles 60 Hz A

1:7

ECM	LOC	SUMMARY OF MODIFICATIONS	EXECUTED	CHECKED	RELEASED	DATE	VER
EXECUTED	PIRWBUSER	THREE PH. MOTOR W40 PREM. EFF.					
CHECKED		FRAME 284T IP23 ODP					
RELEASED							
REL DT.		WMO Jaragua do Sul	Product Engineering	SHEET	1 / 1		

**PREVIEW**  
WDD



**WEG** **W40 NEMA**  
**CC029A Premium**  
*Inverter Duty Motor*



IEC 60034-1  
 MOD.T01#FOXON



For 60Hz use on PWM, VT 1000:1, CT 3:1, 1.0SF

MODEL 015120T3E284T-W40  
 MADE IN BRAZIL  
 14494126

PH 3	FR 284T	HP(kW) 15.0(11.0)		Hz 60	
V 230/460		A 36.8/18.4		RPM 1180	DES B
NEMA NOM EFF 91.7 %		INS. CL. F ΔT 80 K		IP23	
ENCL ODP		DUTY CONT.		AMB. 40°C	
CODE G	PF 0.82	SF 1.25	SFA 46.0/23.0		
USABLE @208V 40.7 A		SF 1.15	SFA 46.8		
10HP 7.5kW 50Hz 380V 15.8A 980RPM SF1.00 EFF 89.1% (IE3)				ALT 1000 m.a.s.l.	

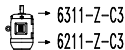
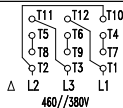
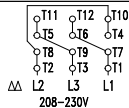

→ 6311-Z-C3  
 → 6211-Z-C3

MOBIL POLYREX EM  
 18 g 20000 h

315 Lbs