

DATA SHEET

Three Phase Induction Motor - Squirrel Cage



Customer							
Product line		: NEMA Premium Efficiency Three-Phase		Product code :		12424291	
				Catalog # :		01512ST3QIE284TC-W22	
Frame		: 284/6TC		Cooling method		: IC411 - TEFC	
Insulation class		: F		Mounting		: F-1	
Duty cycle		: Cont.(S1)		Rotation ¹		: Both (CW and CCW)	
Ambient temperature		: -20°C to +40°C		Starting method		: Direct On Line	
Altitude		: 1000 m.a.s.l.		Approx. weight ²		: 430 lb	
Protection degree		: IP55		Moment of inertia (J)		: 7.85 sq.ft.lb	
Design		: B					
Output [HP]	15	10	10	10	15	15	15
Poles	6	6	6	6	6	6	6
Frequency [Hz]	60	50	50	50	50	50	50
Rated voltage [V]	460	380	400	415	380	400	415
Rated current [A]	17.9	15.5	15.1	14.9	22.0	20.9	20.2
L. R. Amperes [A]	115	112	119	124	103	111	115
LRC [A]	6.4x(Code G)	7.2x(Code J)	7.9x(Code K)	8.3x(Code K)	4.7x(Code E)	5.3x(Code F)	5.7x(Code F)
No load current [A]	7.00	7.00	7.40	7.70	7.00	7.40	7.70
Rated speed [RPM]	1175	985	985	985	965	970	975
Slip [%]	2.08	1.50	1.50	1.50	3.50	3.00	2.50
Rated torque [ft.lb]	67.0	53.3	53.3	53.3	81.6	81.2	80.8
Locked rotor torque [%]	229	270	300	330	170	200	220
Breakdown torque [%]	260	300	340	360	210	229	250
Service factor	1.25	1.25	1.25	1.25	1.00	1.15	1.15
Temperature rise	80 K	80 K	80 K	80 K	80 K	80 K	80 K
Locked rotor time	36s (cold)	61s (cold)	54s (cold)	52s (cold)	27s (cold)	27s (cold)	27s (cold)
	20s (hot)	34s (hot)	30s (hot)	29s (hot)	15s (hot)	15s (hot)	15s (hot)
Noise level ²	59.0 dB(A)	56.0 dB(A)	56.0 dB(A)	56.0 dB(A)	56.0 dB(A)	56.0 dB(A)	56.0 dB(A)
Efficiency (%)	25%	90.8	88.9	89.0	89.0	92.4	90.6
	50%	91.0	89.0	89.1	89.1	91.0	90.2
	75%	91.7	89.4	89.5	89.5	90.2	90.2
	100%	91.7	89.4	89.5	89.5	88.5	89.5
Power Factor	25%	0.44	0.39	0.36	0.34	0.50	0.47
	50%	0.69	0.64	0.61	0.58	0.75	0.72
	75%	0.80	0.76	0.73	0.71	0.84	0.82
	100%	0.84	0.82	0.80	0.78	0.86	0.85
Bearing type	: Drive end Non drive end		6311 C3 6211 C3		Foundation loads		
	: Inpro/Seal Inpro/Seal		20000 h 20000 h		Max. traction : 666 lb		
Lubrication interval	: 20000 h 20000 h		Max. compression : 1096 lb				
Lubricant amount	: 18 g 11 g						
Lubricant type	: Mobil Polyrex EM						
Notes							
This revision replaces and cancel the previous one, which must be eliminated. (1) Looking the motor from the shaft end. (2) Measured at 1m and with tolerance of +3dB(A). (3) Approximate weight subject to changes after manufacturing process. (4) At 100% of full load.				These are average values based on tests with sinusoidal power supply, subject to the tolerances stipulated in NEMA MG-1.			
Rev.	Changes Summary			Performed	Checked	Date	
Performed by							
Checked by					Page	Revision	
Date	13/04/2022				1 / 36		

TORQUE AND CURRENT VS SPEED CURVE

Three Phase Induction Motor - Squirrel Cage



Customer :

Product line : NEMA Premium Efficiency Three-Phase

Product code : 12424291

Catalog # : 01512ST3QIE284TC-W22

TORQUE AND CURRENT VS SPEED CURVE

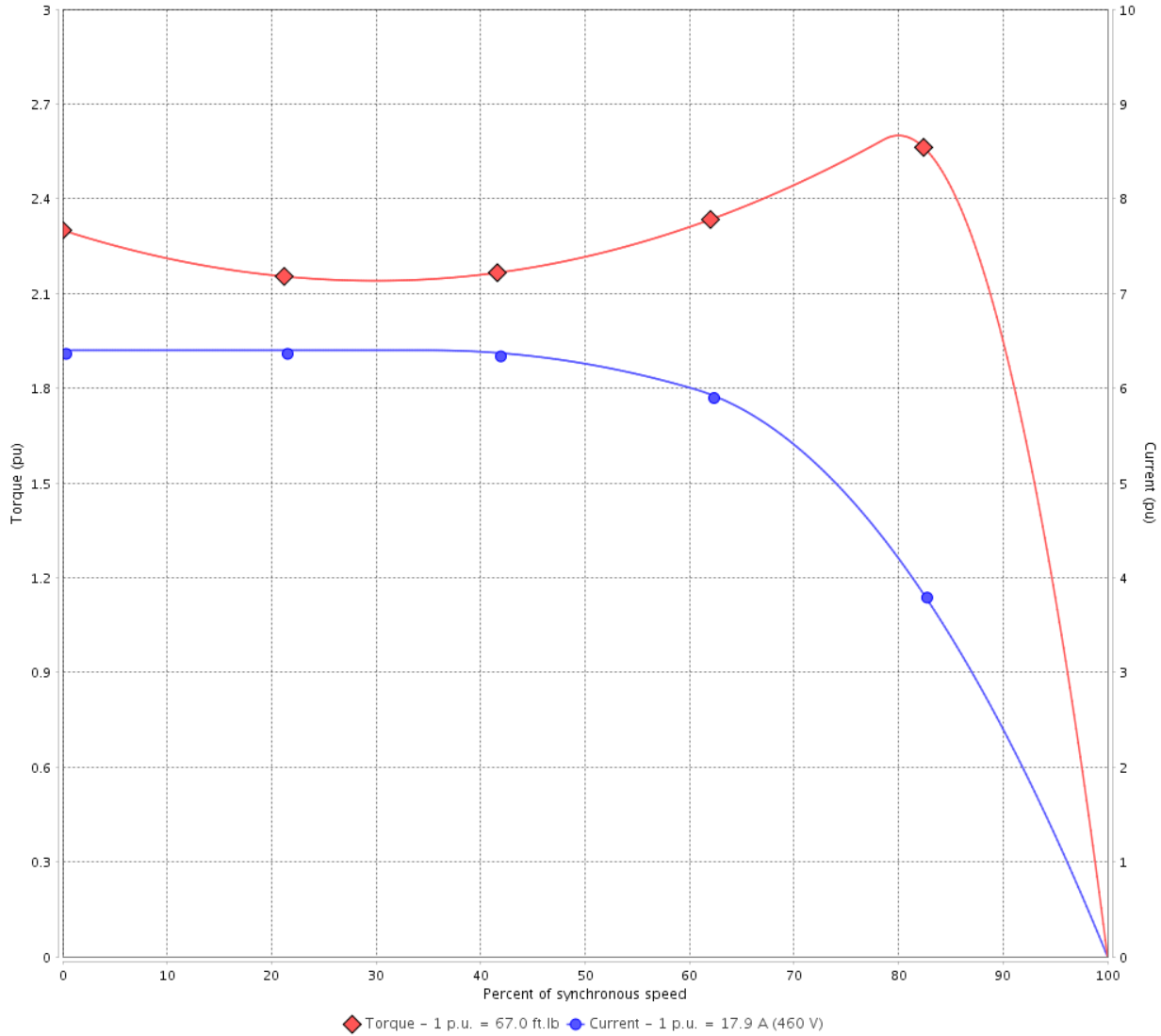

Performance : 460 V 60 Hz 6P

Rated current	: 17.9 A	Moment of inertia (J)	: 7.85 sq.ft.lb
LRC	: 6.4	Duty cycle	: Cont.(S1)
Rated torque	: 67.0 ft.lb	Insulation class	: F
Locked rotor torque	: 229 %	Service factor	: 1.25
Breakdown torque	: 260 %	Temperature rise	: 80 K
Rated speed	: 1175 rpm	Design	: B

Locked rotor time : 36s (cold) 20s (hot)

Rev.	Changes Summary	Performed	Checked	Date
Performed by			Page 2 / 36	Revision
Checked by				
Date	13/04/2022			

TORQUE AND CURRENT VS SPEED CURVE



Three Phase Induction Motor - Squirrel Cage

Customer :

Product line : NEMA Premium Efficiency Three-Phase

Product code : 12424291

Catalog # : 01512ST3QIE284TC-W22

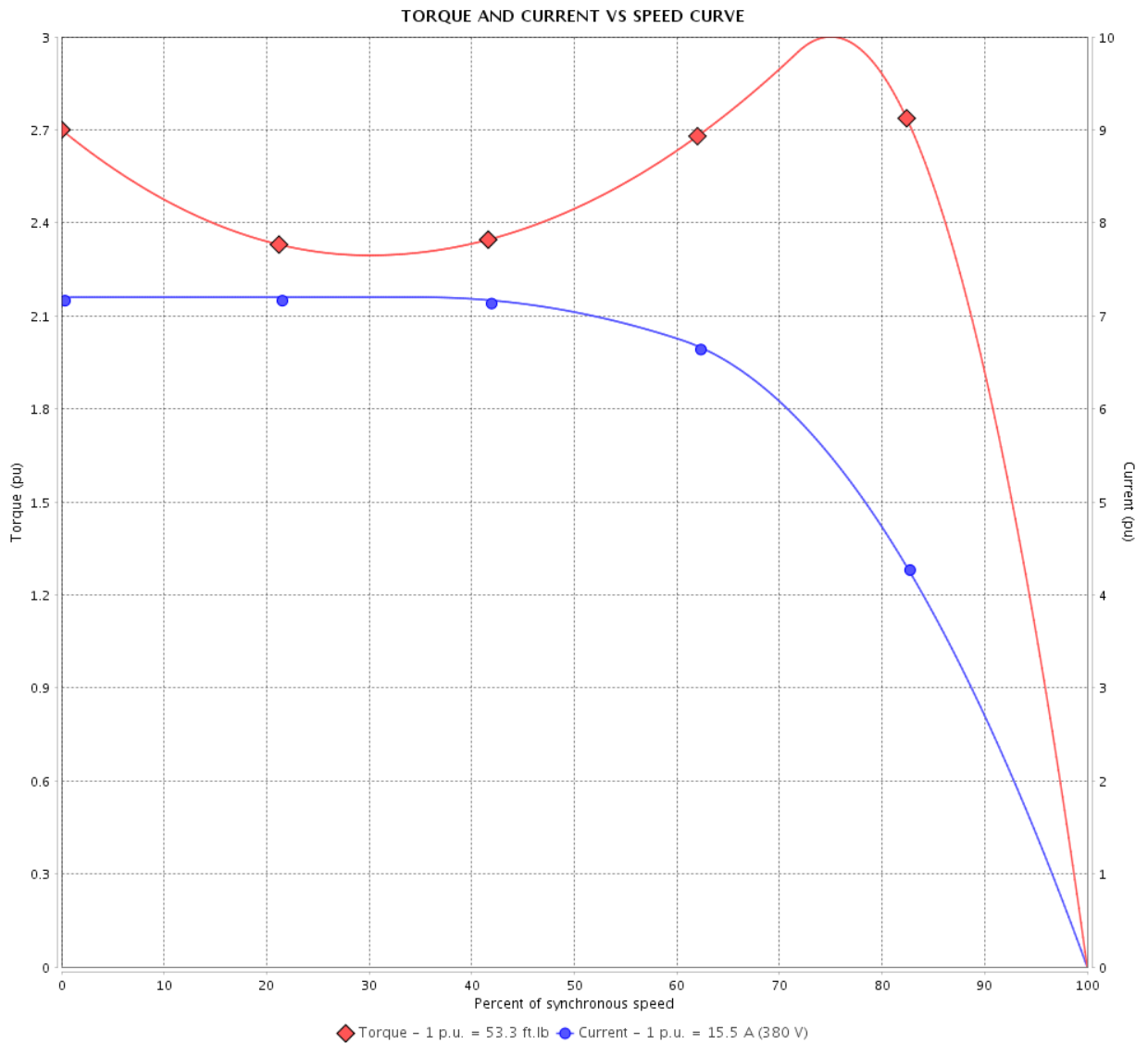

Performance : 380 V 50 Hz 6P IE3

Rated current	: 15.5 A	Moment of inertia (J)	: 7.85 sq.ft.lb
LRC	: 7.2	Duty cycle	: Cont.(S1)
Rated torque	: 53.3 ft.lb	Insulation class	: F
Locked rotor torque	: 270 %	Service factor	: 1.25
Breakdown torque	: 300 %	Temperature rise	: 80 K
Rated speed	: 985 rpm	Design	: B

Locked rotor time : 61s (cold) 34s (hot)

Rev.	Changes Summary	Performed	Checked	Date
Performed by			Page 3 / 36	Revision
Checked by				
Date	13/04/2022			

TORQUE AND CURRENT VS SPEED CURVE

Three Phase Induction Motor - Squirrel Cage



Customer :

Product line : NEMA Premium Efficiency Three-Phase

Product code : 12424291

Catalog # : 01512ST3QIE284TC-W22

TORQUE AND CURRENT VS SPEED CURVE

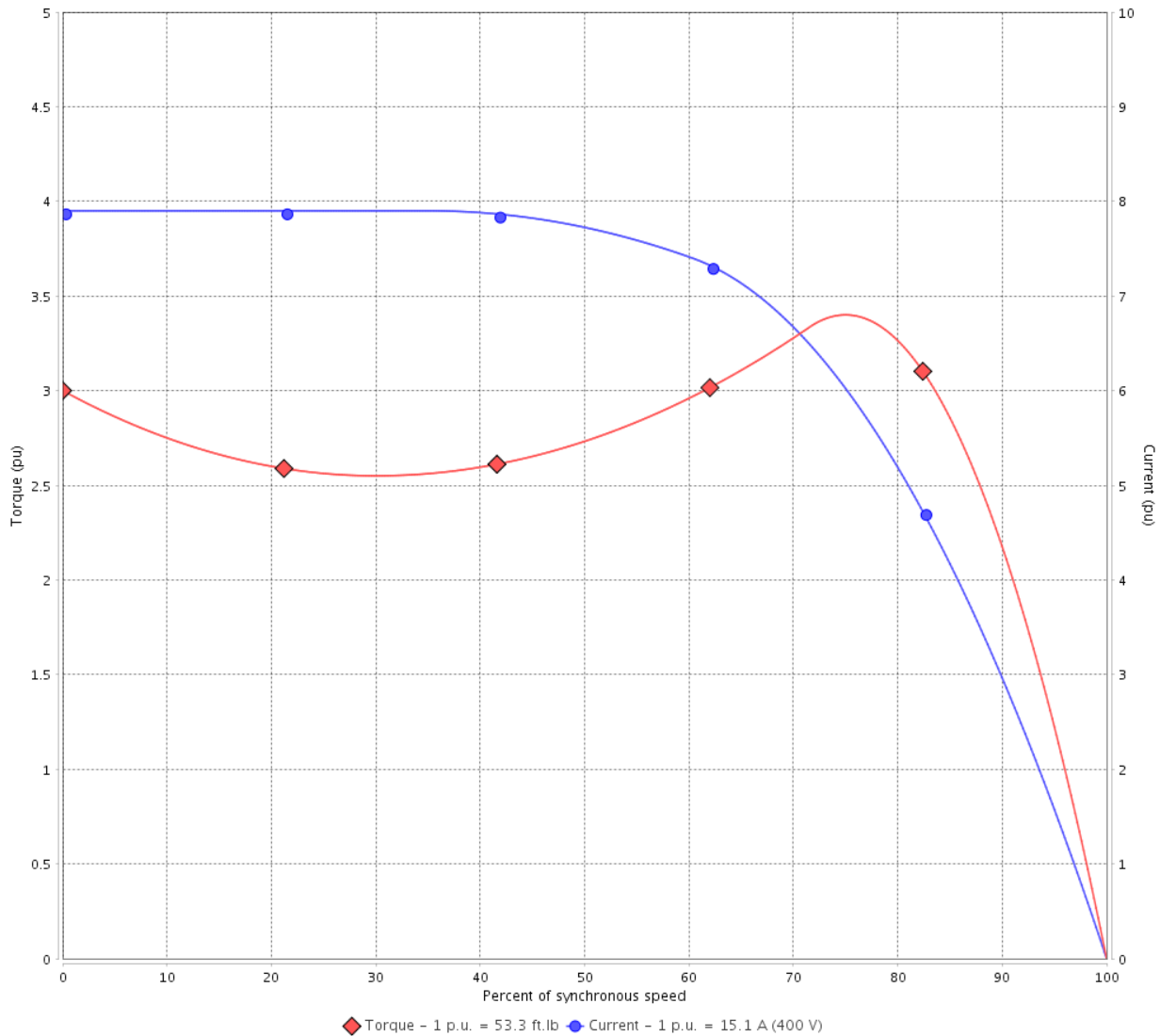

Performance : 400 V 50 Hz 6P IE3

Rated current	: 15.1 A	Moment of inertia (J)	: 7.85 sq.ft.lb
LRC	: 7.9	Duty cycle	: Cont.(S1)
Rated torque	: 53.3 ft.lb	Insulation class	: F
Locked rotor torque	: 300 %	Service factor	: 1.25
Breakdown torque	: 340 %	Temperature rise	: 80 K
Rated speed	: 985 rpm	Design	: B

Locked rotor time : 54s (cold) 30s (hot)

Rev.	Changes Summary	Performed	Checked	Date
Performed by			Page 4 / 36	Revision
Checked by				
Date	13/04/2022			

TORQUE AND CURRENT VS SPEED CURVE



Three Phase Induction Motor - Squirrel Cage

Customer :

Product line : NEMA Premium Efficiency Three-Phase

Product code : 12424291

Catalog # : 01512ST3QIE284TC-W22

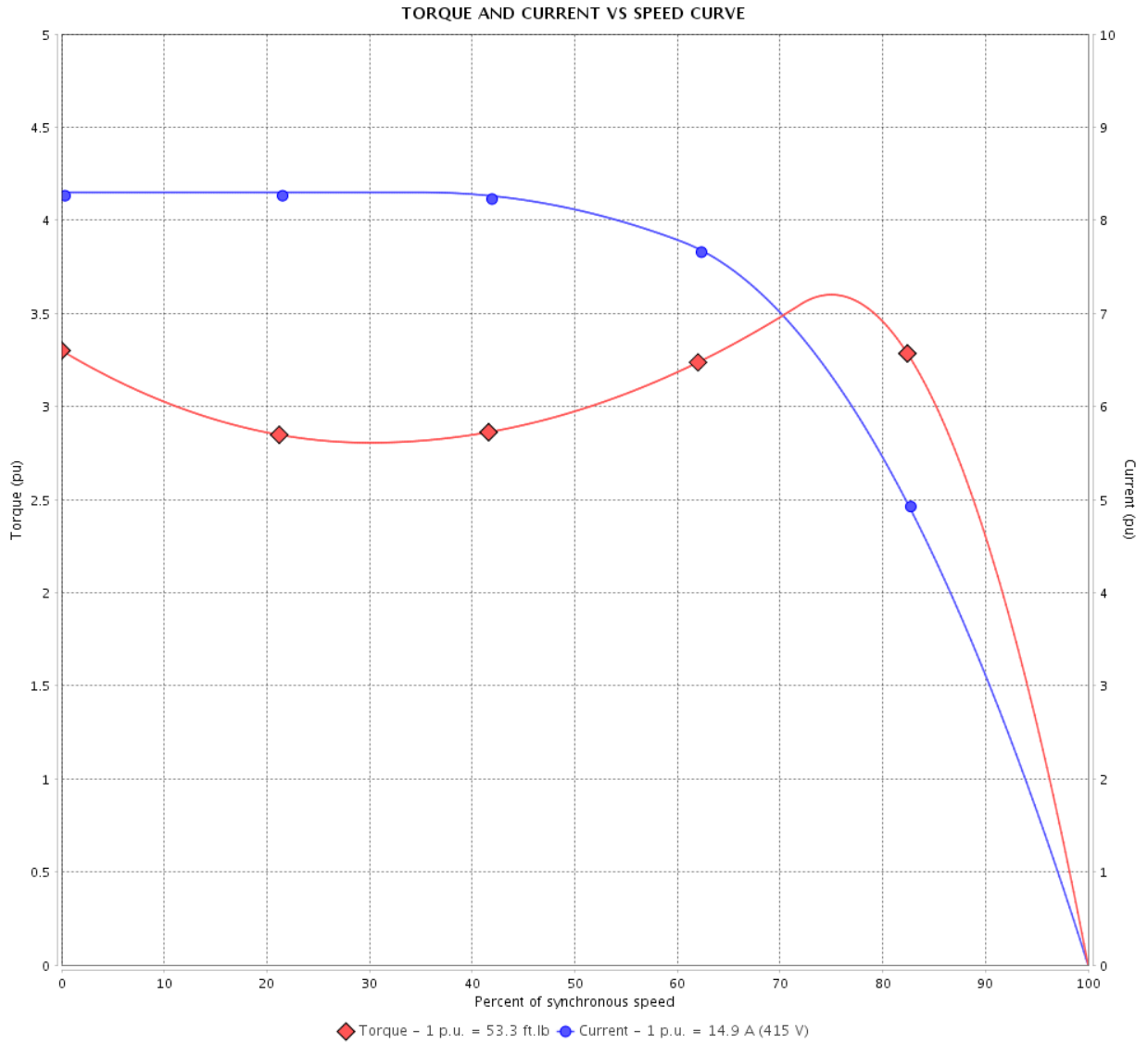

Performance : 415 V 50 Hz 6P IE3

Rated current	: 14.9 A	Moment of inertia (J)	: 7.85 sq.ft.lb
LRC	: 8.3	Duty cycle	: Cont.(S1)
Rated torque	: 53.3 ft.lb	Insulation class	: F
Locked rotor torque	: 330 %	Service factor	: 1.25
Breakdown torque	: 360 %	Temperature rise	: 80 K
Rated speed	: 985 rpm	Design	: B

Locked rotor time : 52s (cold) 29s (hot)

Rev.	Changes Summary	Performed	Checked	Date
Performed by			Page 5 / 36	Revision
Checked by				
Date	13/04/2022			

TORQUE AND CURRENT VS SPEED CURVE

Three Phase Induction Motor - Squirrel Cage



Customer :

Product line : NEMA Premium Efficiency Three-Phase

Product code : 12424291

Catalog # : 01512ST3QIE284TC-W22

TORQUE AND CURRENT VS SPEED CURVE

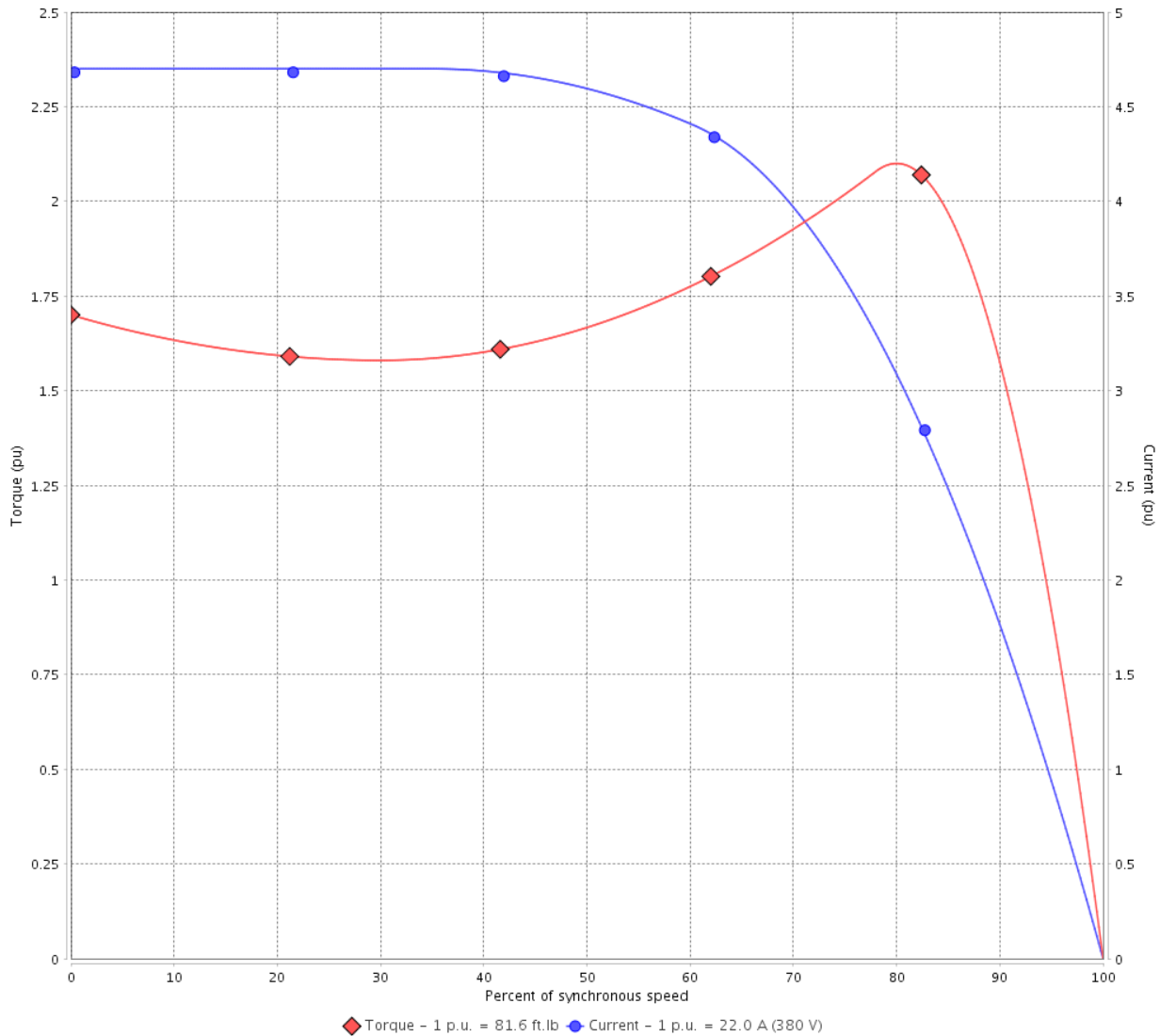

Performance : 380 V 50 Hz 6P IE1

Rated current	: 22.0 A	Moment of inertia (J)	: 7.85 sq.ft.lb
LRC	: 4.7	Duty cycle	: Cont.(S1)
Rated torque	: 81.6 ft.lb	Insulation class	: F
Locked rotor torque	: 170 %	Service factor	: 1.00
Breakdown torque	: 210 %	Temperature rise	: 80 K
Rated speed	: 965 rpm	Design	: B

Locked rotor time : 27s (cold) 15s (hot)

Rev.	Changes Summary	Performed	Checked	Date
Performed by			Page 6 / 36	Revision
Checked by				
Date	13/04/2022			

TORQUE AND CURRENT VS SPEED CURVE



Three Phase Induction Motor - Squirrel Cage

Customer :

Product line : NEMA Premium Efficiency Three-Phase

Product code : 12424291

Catalog # : 01512ST3QIE284TC-W22

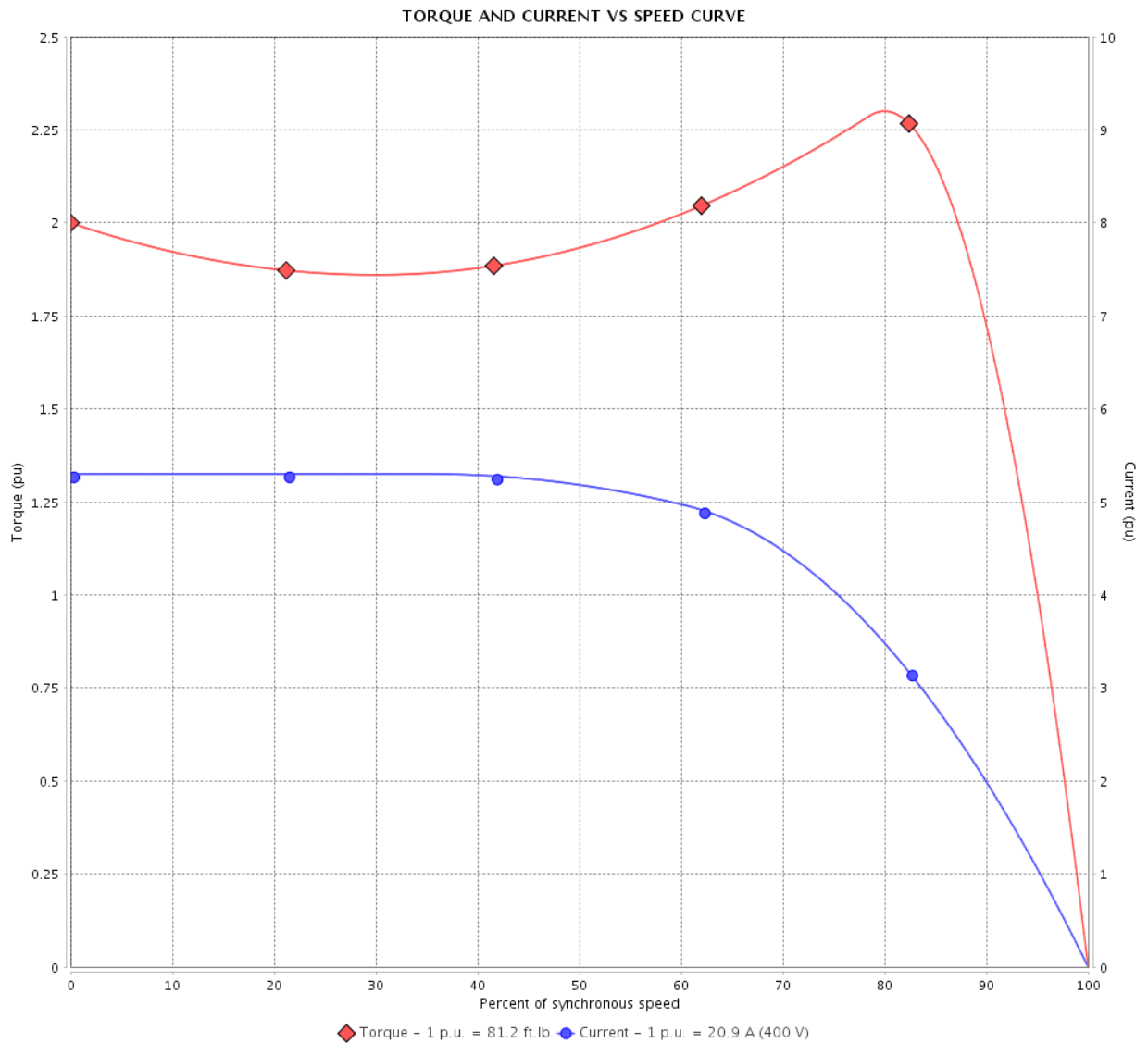

Performance : 400 V 50 Hz 6P IE2

Rated current	: 20.9 A	Moment of inertia (J)	: 7.85 sq.ft.lb
LRC	: 5.3	Duty cycle	: Cont.(S1)
Rated torque	: 81.2 ft.lb	Insulation class	: F
Locked rotor torque	: 200 %	Service factor	: 1.15
Breakdown torque	: 229 %	Temperature rise	: 80 K
Rated speed	: 970 rpm	Design	: B

Locked rotor time : 27s (cold) 15s (hot)

Rev.	Changes Summary	Performed	Checked	Date
Performed by			Page 7 / 36	Revision
Checked by				
Date	13/04/2022			

TORQUE AND CURRENT VS SPEED CURVE

Three Phase Induction Motor - Squirrel Cage



Customer :

Product line : NEMA Premium Efficiency Three-Phase

Product code : 12424291

Catalog # : 01512ST3QIE284TC-W22

TORQUE AND CURRENT VS SPEED CURVE

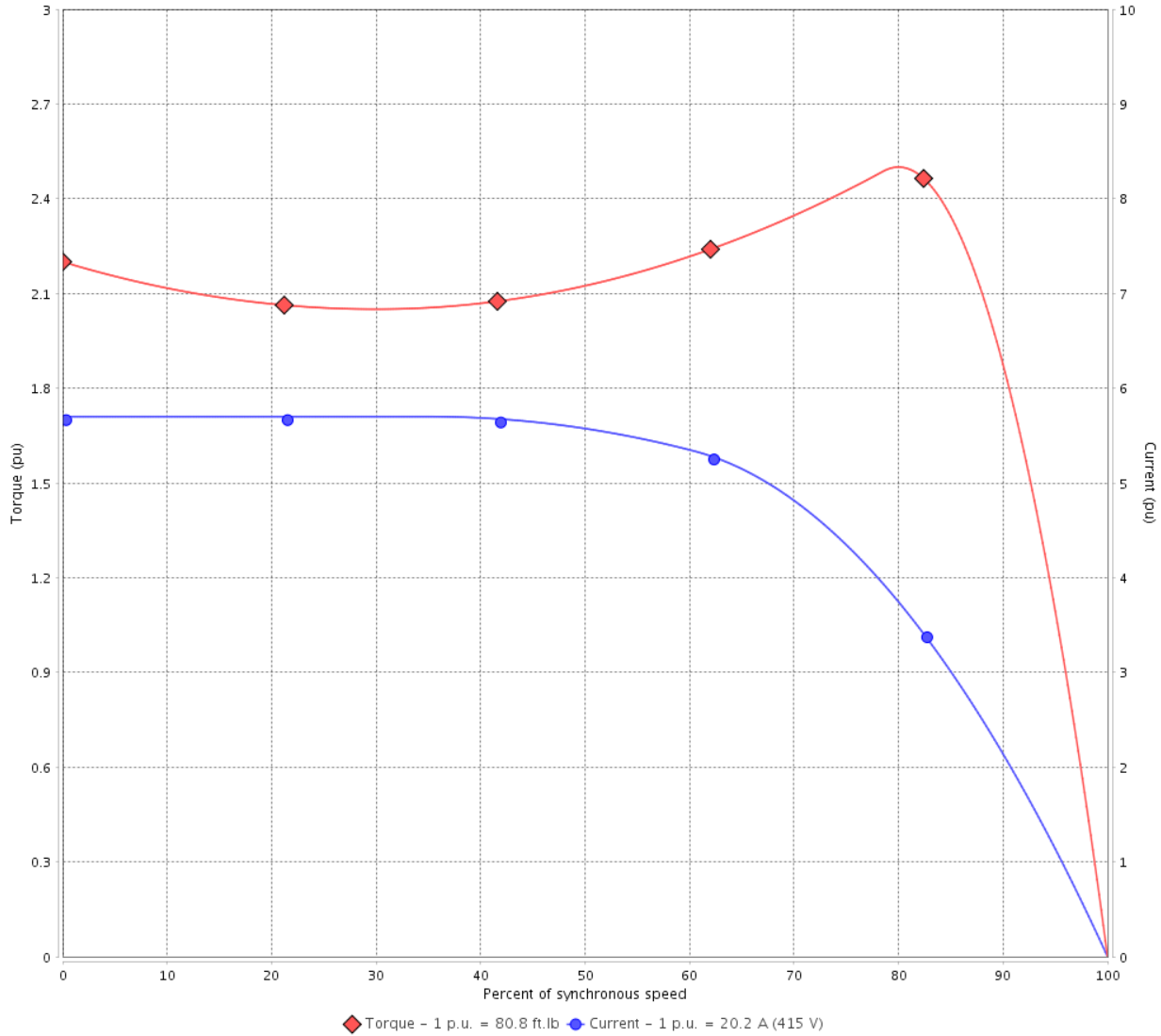

Performance : 415 V 50 Hz 6P IE2

Rated current	: 20.2 A	Moment of inertia (J)	: 7.85 sq.ft.lb
LRC	: 5.7	Duty cycle	: Cont.(S1)
Rated torque	: 80.8 ft.lb	Insulation class	: F
Locked rotor torque	: 220 %	Service factor	: 1.15
Breakdown torque	: 250 %	Temperature rise	: 80 K
Rated speed	: 975 rpm	Design	: B

Locked rotor time : 27s (cold) 15s (hot)

Rev.	Changes Summary	Performed	Checked	Date
Performed by			Page 8 / 36	Revision
Checked by				
Date	13/04/2022			

LOAD PERFORMANCE CURVE

Three Phase Induction Motor - Squirrel Cage



Customer :

Product line : NEMA Premium Efficiency Three-Phase

Product code : 12424291

Catalog # : 01512ST3QIE284TC-W22

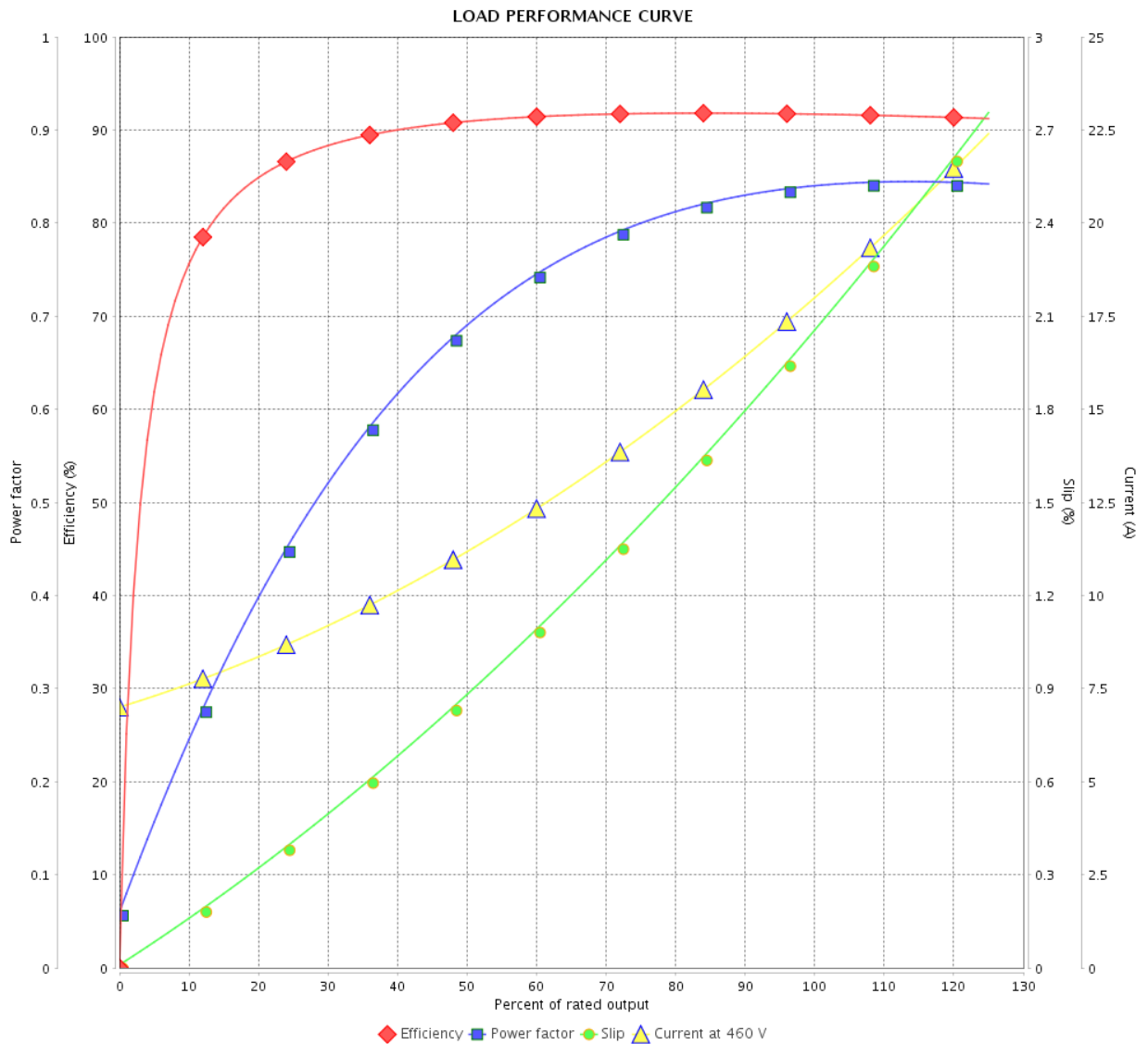

Performance : 460 V 60 Hz 6P

Rated current : 17.9 A
 LRC : 6.4
 Rated torque : 67.0 ft.lb
 Locked rotor torque : 229 %
 Breakdown torque : 260 %
 Rated speed : 1175 rpm

Moment of inertia (J) : 7.85 sq.ft.lb
 Duty cycle : Cont.(S1)
 Insulation class : F
 Service factor : 1.25
 Temperature rise : 80 K
 Design : B

Rev.	Changes Summary	Performed	Checked	Date
Performed by			Page	Revision
Checked by				
Date				

LOAD PERFORMANCE CURVE

Three Phase Induction Motor - Squirrel Cage



Customer :

Product line : NEMA Premium Efficiency Three-Phase

Product code : 12424291

Catalog # : 01512ST3QIE284TC-W22

LOAD PERFORMANCE CURVE

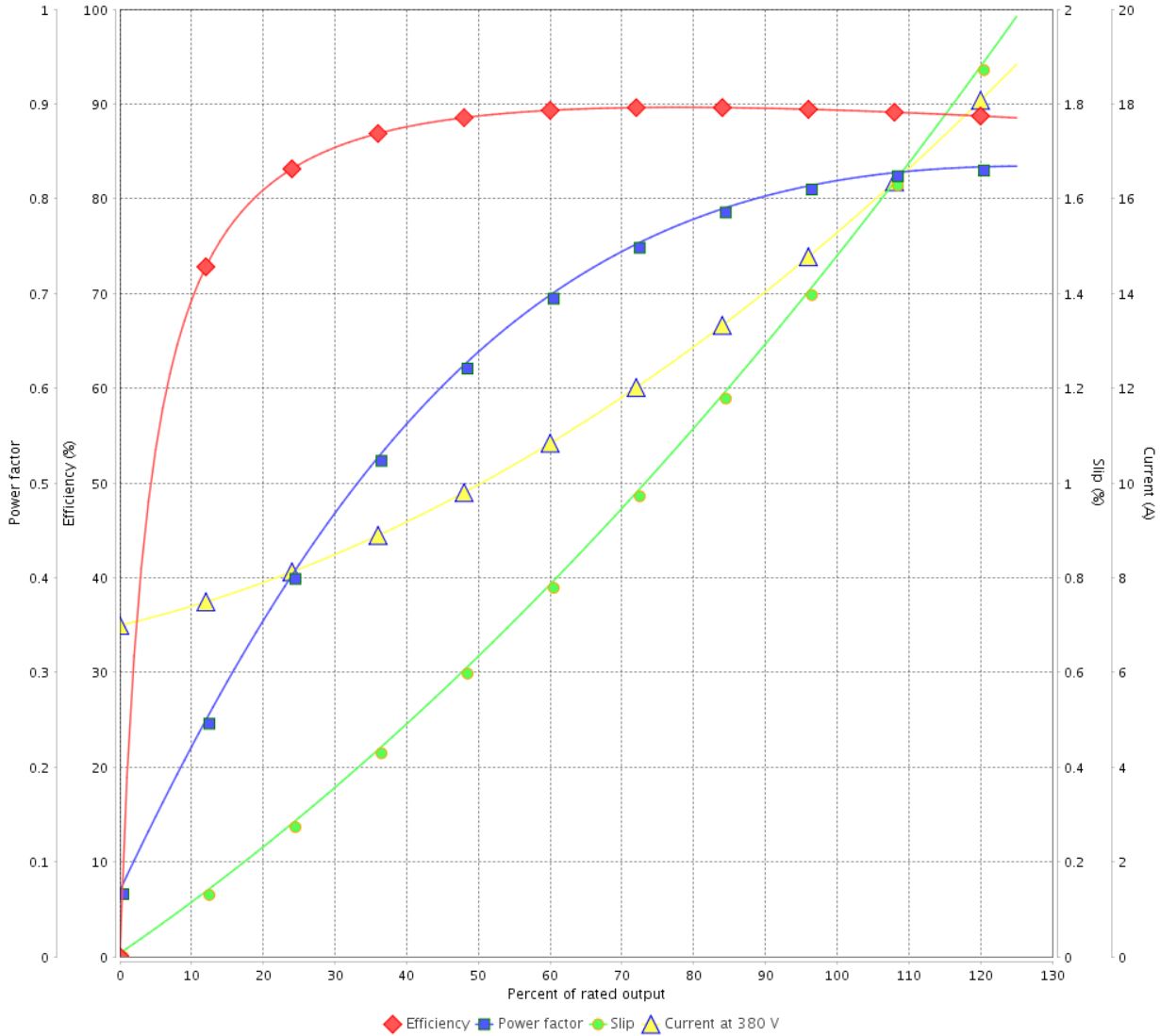

Performance : 380 V 50 Hz 6P IE3

Rated current : 15.5 A
 LRC : 7.2
 Rated torque : 53.3 ft.lb
 Locked rotor torque : 270 %
 Breakdown torque : 300 %
 Rated speed : 985 rpm

Moment of inertia (J) : 7.85 sq.ft.lb
 Duty cycle : Cont.(S1)
 Insulation class : F
 Service factor : 1.25
 Temperature rise : 80 K
 Design : B

Rev.	Changes Summary	Performed	Checked	Date
Performed by			Page	Revision
Checked by			10 / 36	
Date	13/04/2022			

LOAD PERFORMANCE CURVE

Three Phase Induction Motor - Squirrel Cage



Customer :

Product line : NEMA Premium Efficiency Three-Phase

Product code : 12424291

Catalog # : 01512ST3QIE284TC-W22

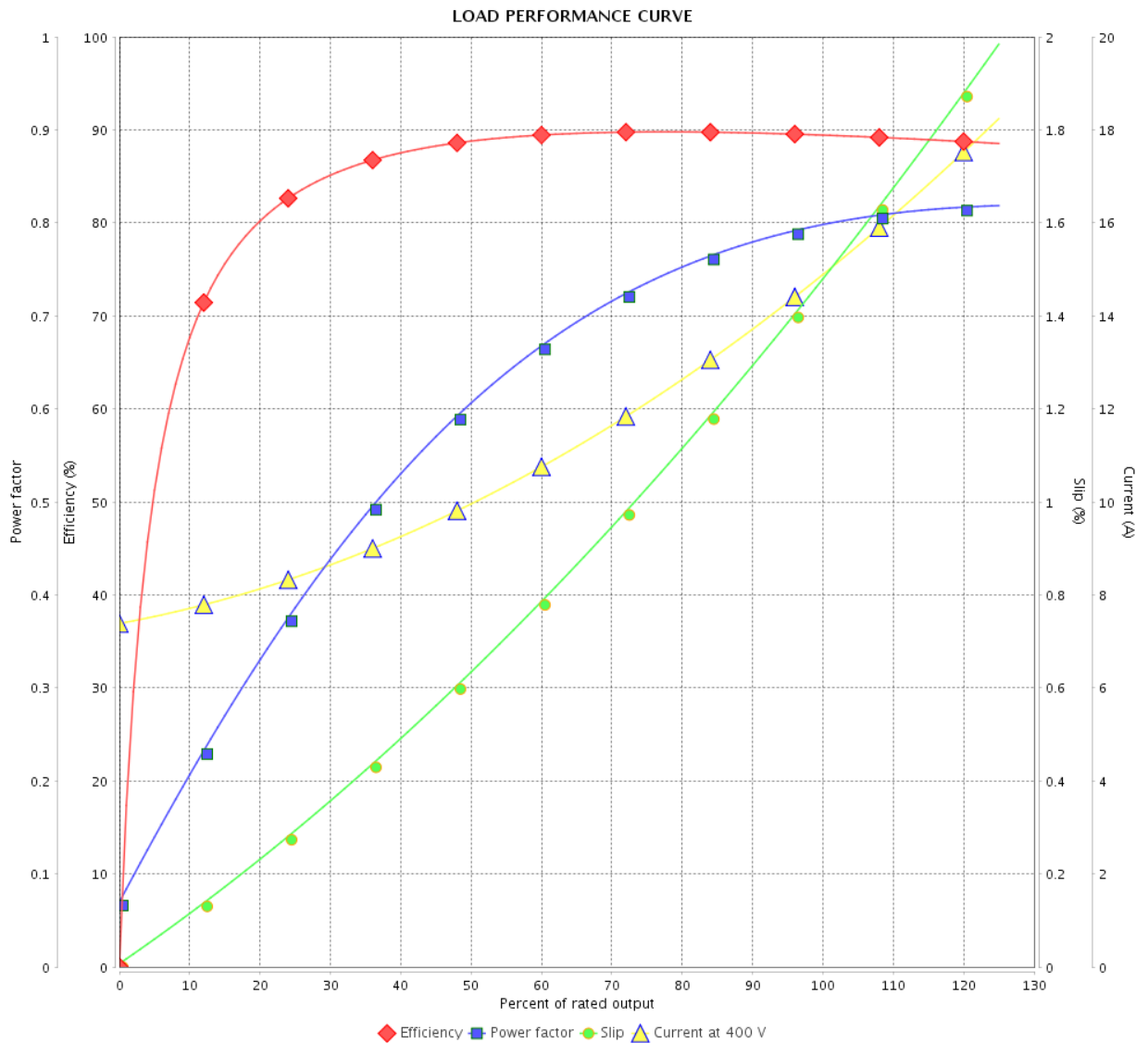

Performance : 400 V 50 Hz 6P IE3

Rated current : 15.1 A
 LRC : 7.9
 Rated torque : 53.3 ft.lb
 Locked rotor torque : 300 %
 Breakdown torque : 340 %
 Rated speed : 985 rpm

Moment of inertia (J) : 7.85 sq.ft.lb
 Duty cycle : Cont.(S1)
 Insulation class : F
 Service factor : 1.25
 Temperature rise : 80 K
 Design : B

Rev.	Changes Summary	Performed	Checked	Date
Performed by		Page		Revision
Checked by		11 / 36		
Date		13/04/2022		

LOAD PERFORMANCE CURVE

Three Phase Induction Motor - Squirrel Cage



Customer :

Product line : NEMA Premium Efficiency Three-Phase

Product code : 12424291

Catalog # : 01512ST3QIE284TC-W22

LOAD PERFORMANCE CURVE

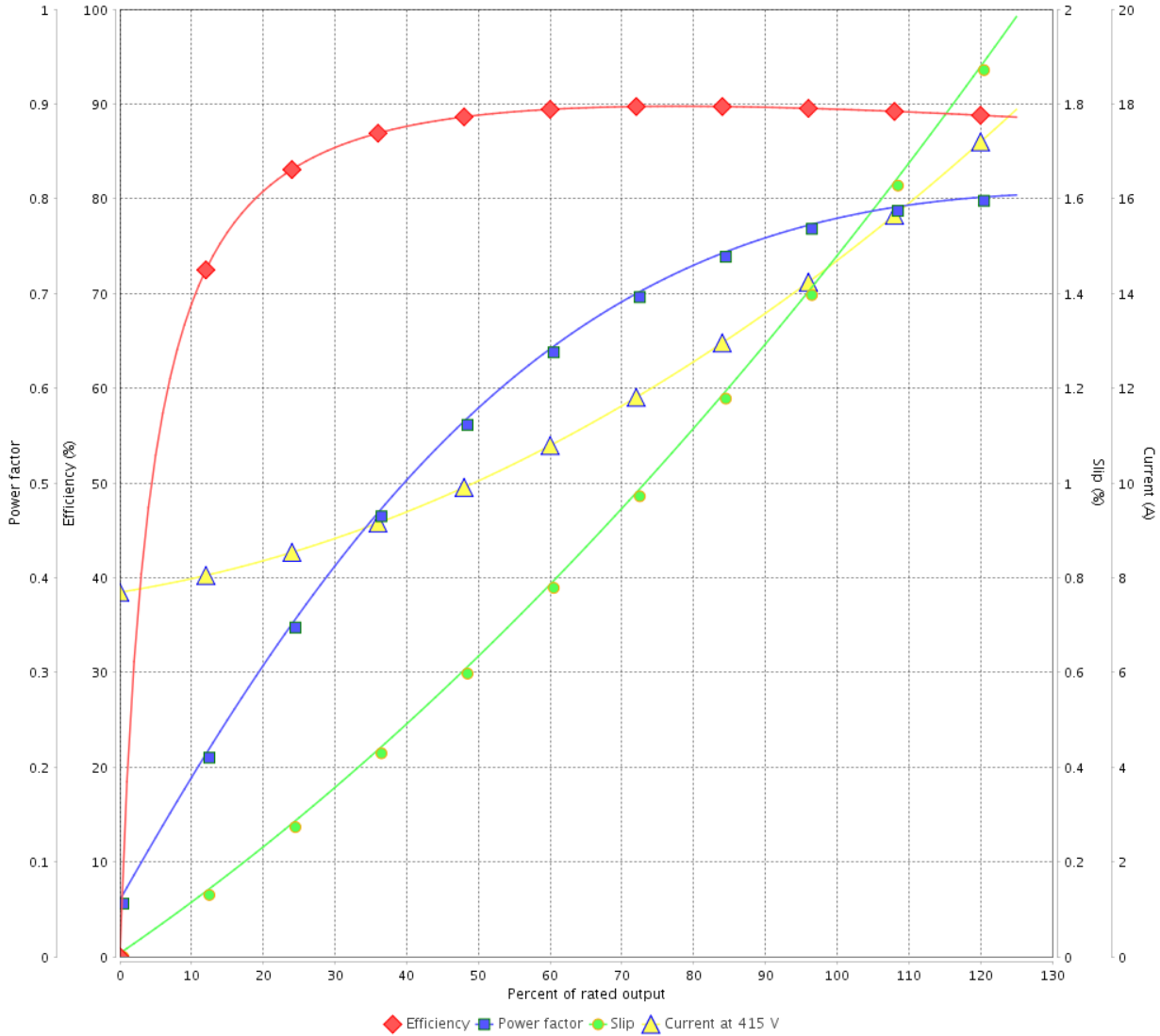

Performance : 415 V 50 Hz 6P IE3

Rated current : 14.9 A
 LRC : 8.3
 Rated torque : 53.3 ft.lb
 Locked rotor torque : 330 %
 Breakdown torque : 360 %
 Rated speed : 985 rpm

Moment of inertia (J) : 7.85 sq.ft.lb
 Duty cycle : Cont.(S1)
 Insulation class : F
 Service factor : 1.25
 Temperature rise : 80 K
 Design : B

Rev.	Changes Summary	Performed	Checked	Date
Performed by			Page 12 / 36	Revision
Checked by				
Date	13/04/2022			

LOAD PERFORMANCE CURVE

Three Phase Induction Motor - Squirrel Cage



Customer : _____

Product line : NEMA Premium Efficiency Three-Phase

Product code : 12424291

Catalog # : 01512ST3QIE284TC-W22

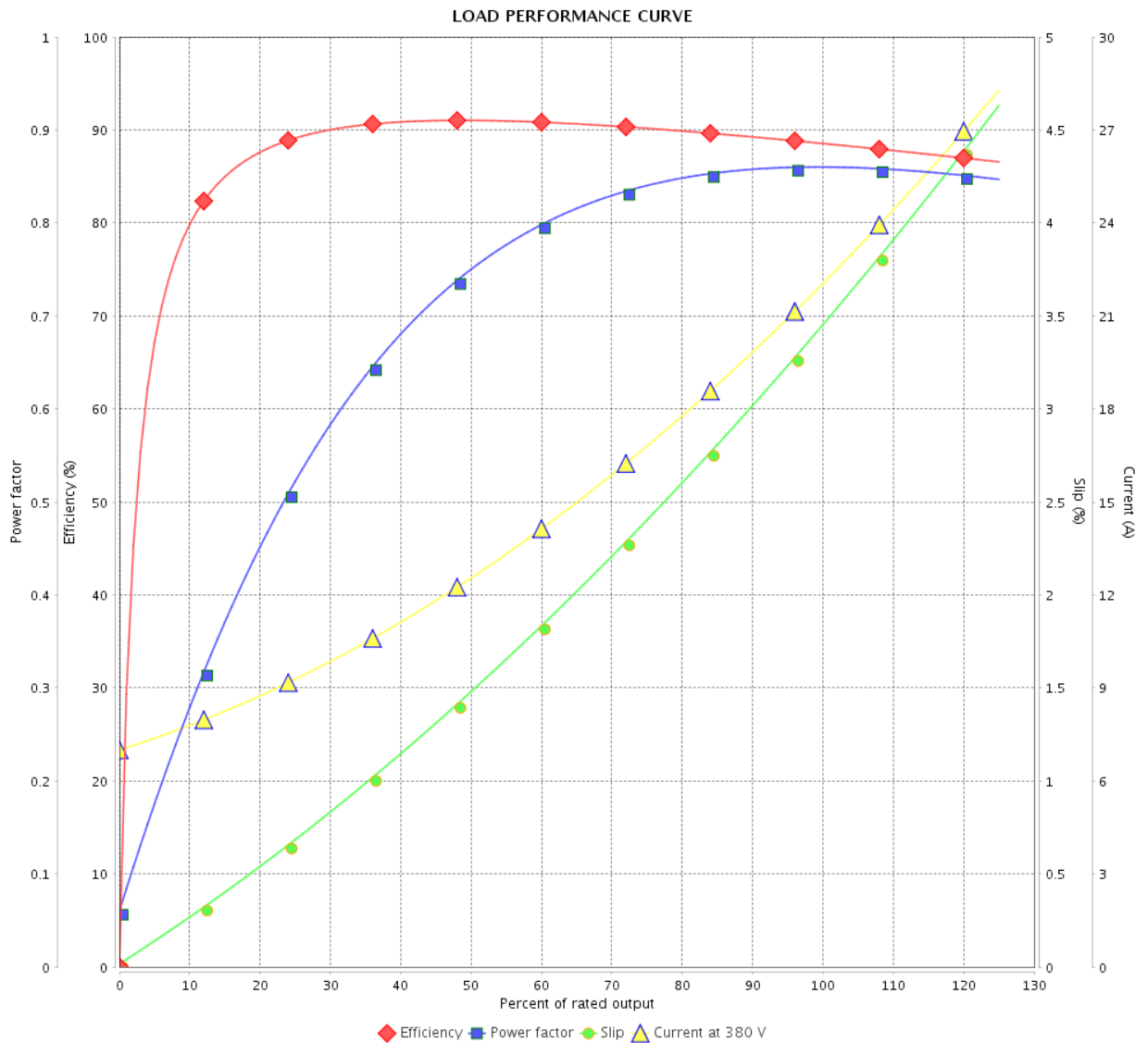

Performance : 380 V 50 Hz 6P IE1

Rated current : 22.0 A
 LRC : 4.7
 Rated torque : 81.6 ft.lb
 Locked rotor torque : 170 %
 Breakdown torque : 210 %
 Rated speed : 965 rpm

Moment of inertia (J) : 7.85 sq.ft.lb
 Duty cycle : Cont.(S1)
 Insulation class : F
 Service factor : 1.00
 Temperature rise : 80 K
 Design : B

Rev.	Changes Summary	Performed	Checked	Date
Performed by		Page		Revision
Checked by		13 / 36		
Date		13/04/2022		

LOAD PERFORMANCE CURVE

Three Phase Induction Motor - Squirrel Cage



Customer :

Product line : NEMA Premium Efficiency Three-Phase

Product code : 12424291

Catalog # : 01512ST3QIE284TC-W22

LOAD PERFORMANCE CURVE

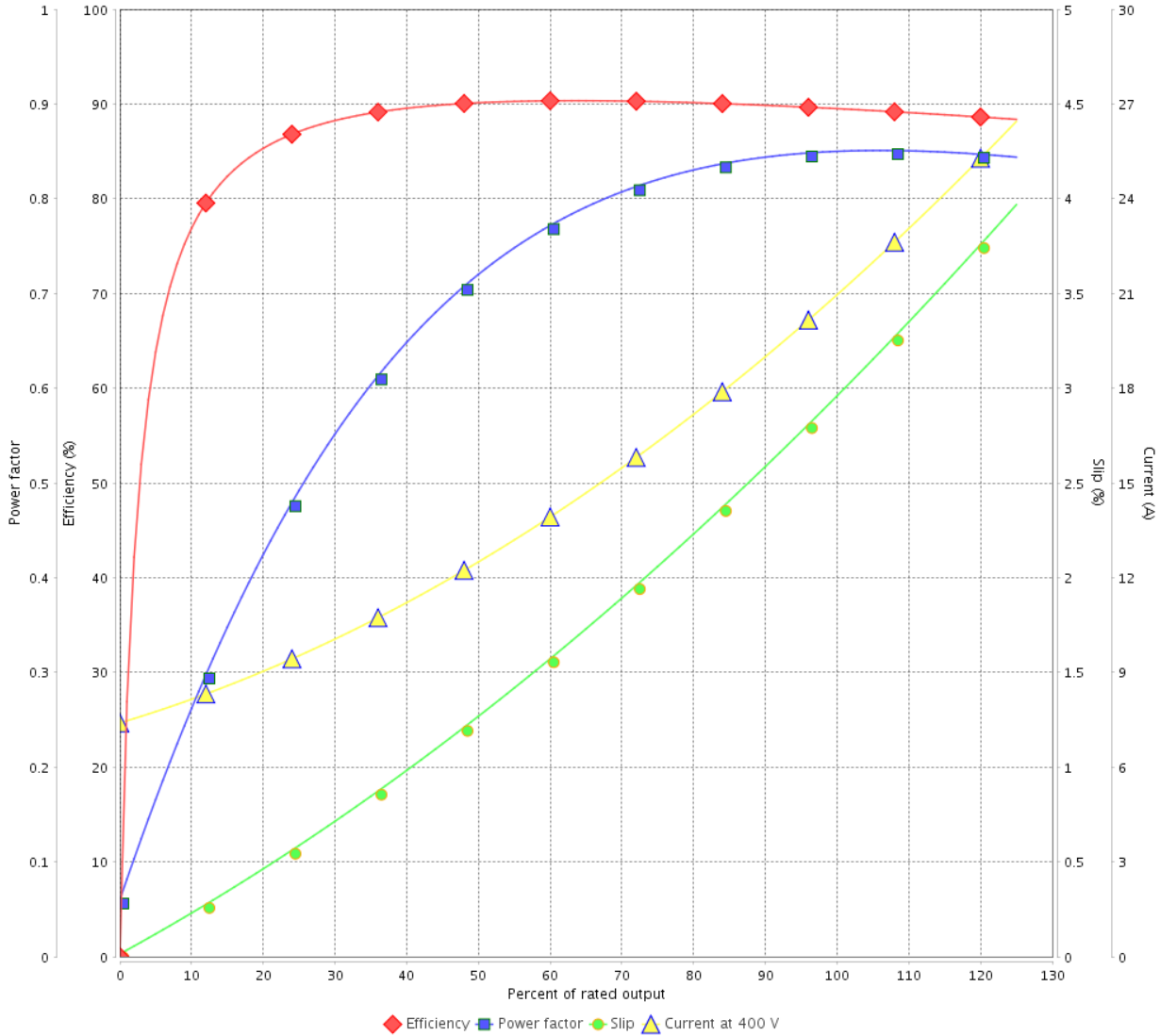

Performance : 400 V 50 Hz 6P IE2

Rated current : 20.9 A
 LRC : 5.3
 Rated torque : 81.2 ft.lb
 Locked rotor torque : 200 %
 Breakdown torque : 229 %
 Rated speed : 970 rpm

Moment of inertia (J) : 7.85 sq.ft.lb
 Duty cycle : Cont.(S1)
 Insulation class : F
 Service factor : 1.15
 Temperature rise : 80 K
 Design : B

Rev.	Changes Summary	Performed	Checked	Date
Performed by		Page		Revision
Checked by		14 / 36		
Date		13/04/2022		

LOAD PERFORMANCE CURVE

Three Phase Induction Motor - Squirrel Cage



Customer :

Product line : NEMA Premium Efficiency Three-Phase

Product code : 12424291

Catalog # : 01512ST3QIE284TC-W22

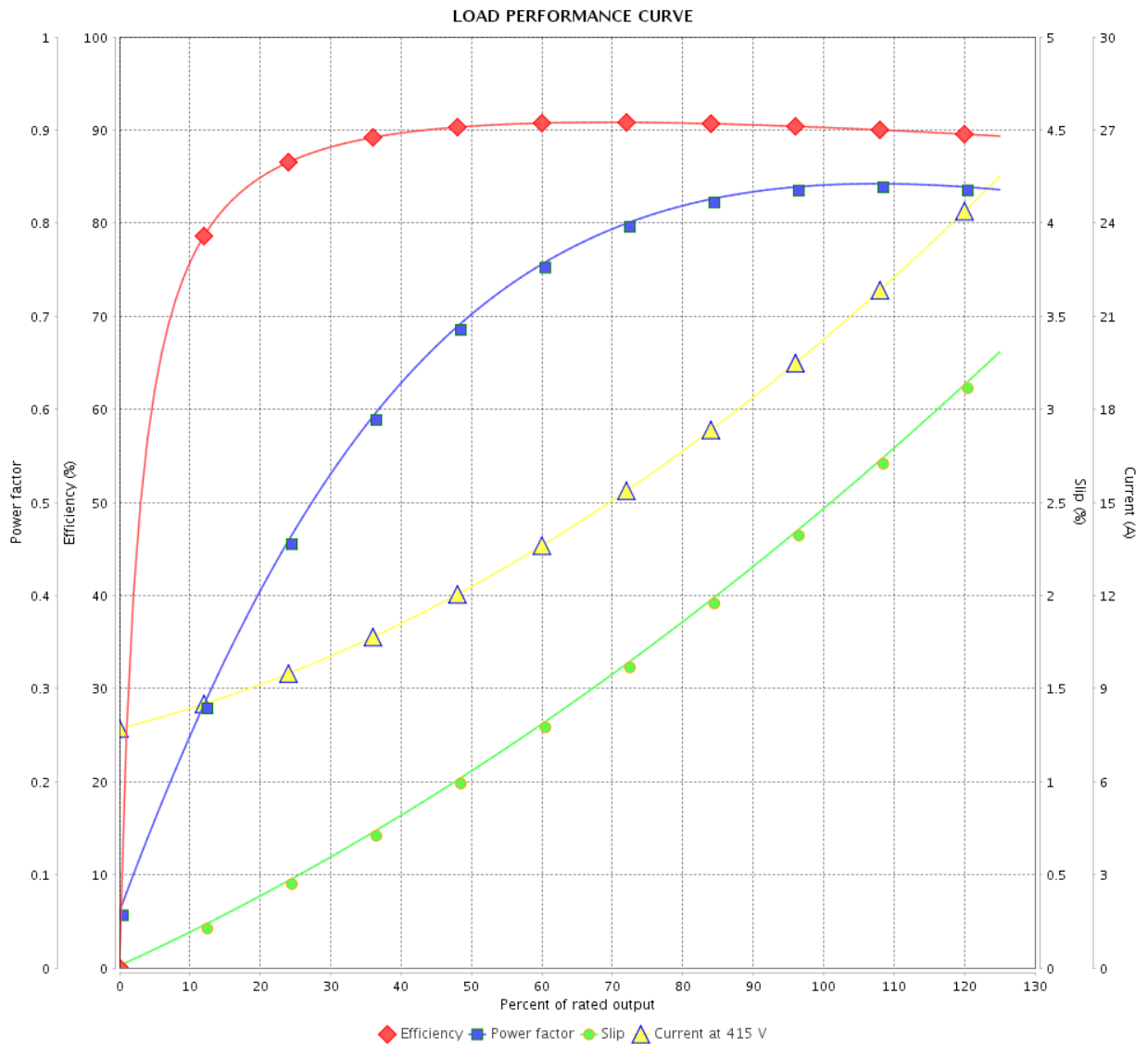

Performance : 415 V 50 Hz 6P IE2

Rated current : 20.2 A
 LRC : 5.7
 Rated torque : 80.8 ft.lb
 Locked rotor torque : 220 %
 Breakdown torque : 250 %
 Rated speed : 975 rpm

Moment of inertia (J) : 7.85 sq.ft.lb
 Duty cycle : Cont.(S1)
 Insulation class : F
 Service factor : 1.15
 Temperature rise : 80 K
 Design : B

Rev.	Changes Summary	Performed	Checked	Date
Performed by		Page		Revision
Checked by		15 / 36		
Date		13/04/2022		

THERMAL LIMIT CURVE



Three Phase Induction Motor - Squirrel Cage

Customer :

Product line : NEMA Premium Efficiency Three-Phase
 Product code : 12424291
 Catalog # : 01512ST3QIE284TC-W22

Performance : 460 V 60 Hz 6P

Rated current : 17.9 A	Moment of inertia (J) : 7.85 sq.ft.lb
LRC : 6.4	Duty cycle : Cont.(S1)
Rated torque : 67.0 ft.lb	Insulation class : F
Locked rotor torque : 229 %	Service factor : 1.25
Breakdown torque : 260 %	Temperature rise : 80 K
Rated speed : 1175 rpm	Design : B

Heating constant

Cooling constant

Rev.	Changes Summary	Performed	Checked	Date
Performed by			Page 16 / 36	Revision
Checked by				
Date	13/04/2022			

THERMAL LIMIT CURVE

Three Phase Induction Motor - Squirrel Cage



Customer : _____

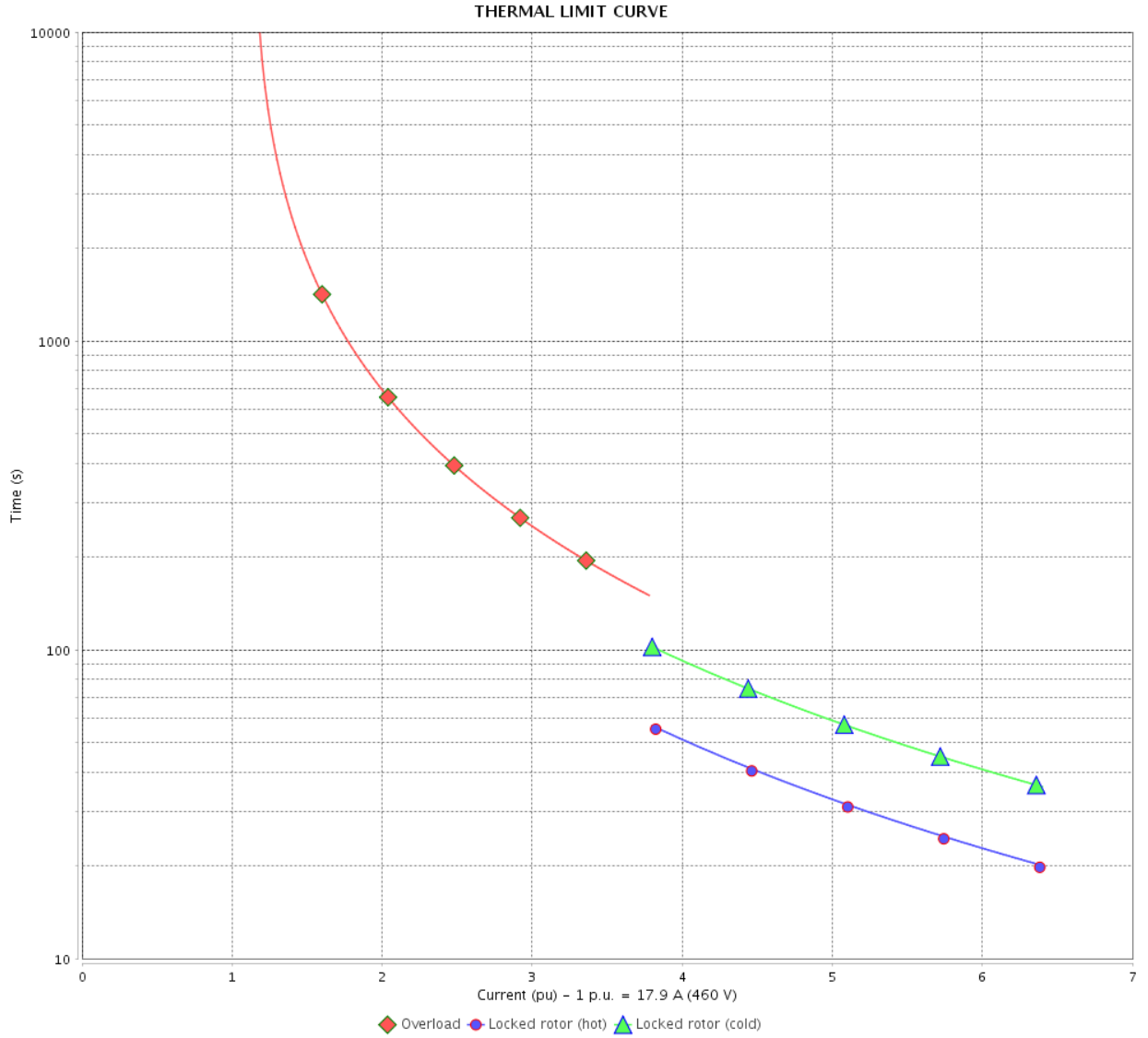

Rev.	Changes Summary	Performed	Checked	Date
Performed by		Page		Revision
Checked by		17 / 36		
Date		13/04/2022		

THERMAL LIMIT CURVE



Three Phase Induction Motor - Squirrel Cage

Customer :

Product line : NEMA Premium Efficiency Three-Phase
Product code : 12424291
Catalog # : 01512ST3QIE284TC-W22

Performance : 380 V 50 Hz 6P IE3

Rated current	: 15.5 A	Moment of inertia (J)	: 7.85 sq.ft.lb
LRC	: 7.2	Duty cycle	: Cont.(S1)
Rated torque	: 53.3 ft.lb	Insulation class	: F
Locked rotor torque	: 270 %	Service factor	: 1.25
Breakdown torque	: 300 %	Temperature rise	: 80 K
Rated speed	: 985 rpm	Design	: B

Heating constant

Cooling constant

Rev.	Changes Summary	Performed	Checked	Date
Performed by				
Checked by			Page	Revision
Date	13/04/2022		18 / 36	

THERMAL LIMIT CURVE

Three Phase Induction Motor - Squirrel Cage



Customer : _____

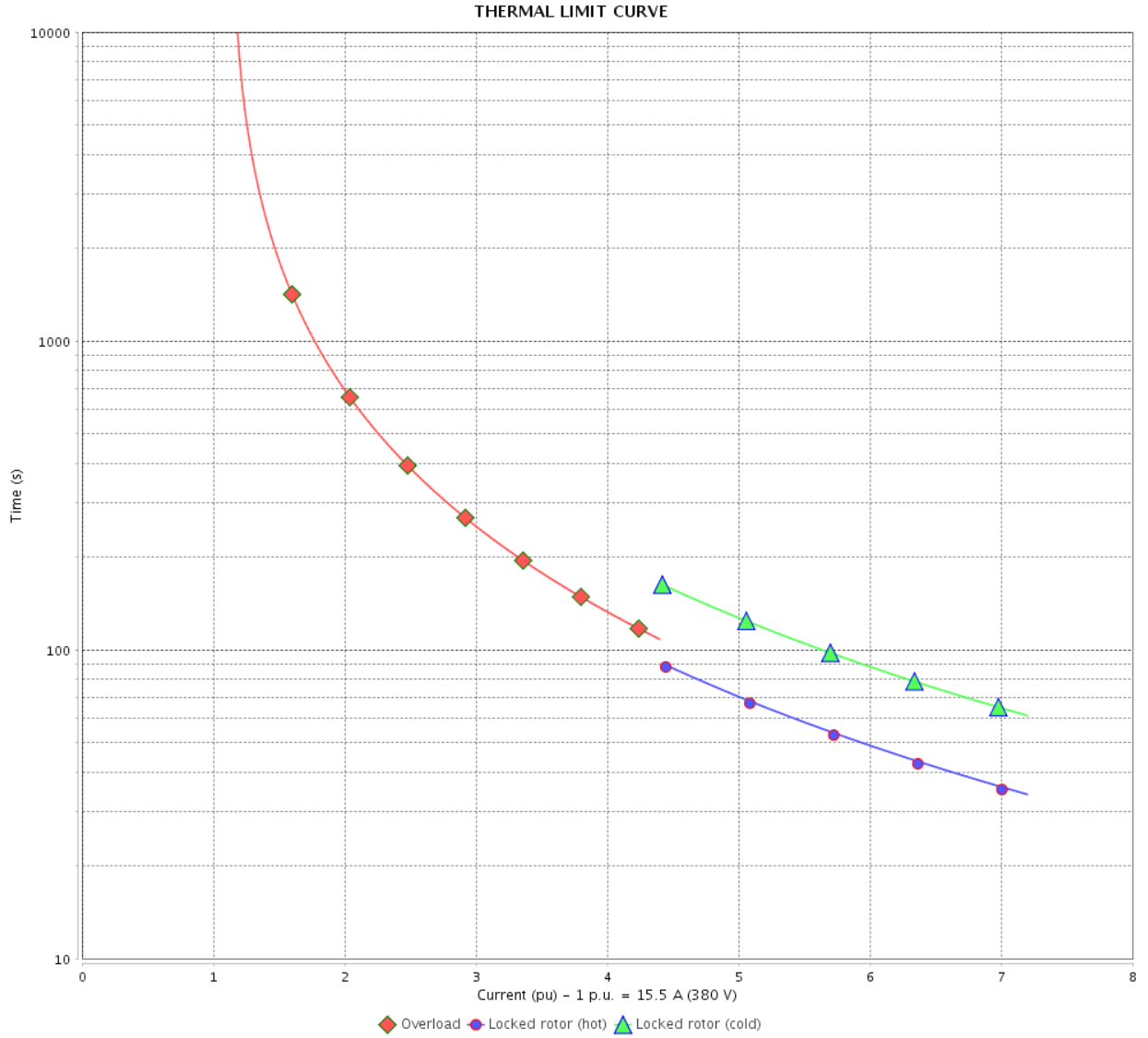

Rev.	Changes Summary	Performed	Checked	Date
Performed by		Page		Revision
Checked by		19 / 36		
Date		13/04/2022		

THERMAL LIMIT CURVE



Three Phase Induction Motor - Squirrel Cage

Customer :

Product line : NEMA Premium Efficiency Three-Phase

Product code : 12424291

Catalog # : 01512ST3QIE284TC-W22

Performance : 400 V 50 Hz 6P IE3

Rated current	: 15.1 A	Moment of inertia (J)	: 7.85 sq.ft.lb
LRC	: 7.9	Duty cycle	: Cont.(S1)
Rated torque	: 53.3 ft.lb	Insulation class	: F
Locked rotor torque	: 300 %	Service factor	: 1.25
Breakdown torque	: 340 %	Temperature rise	: 80 K
Rated speed	: 985 rpm	Design	: B

Heating constant

Cooling constant

Rev.	Changes Summary	Performed	Checked	Date
Performed by				
Checked by			Page	Revision
Date	13/04/2022		20 / 36	

THERMAL LIMIT CURVE

Three Phase Induction Motor - Squirrel Cage



Customer : _____

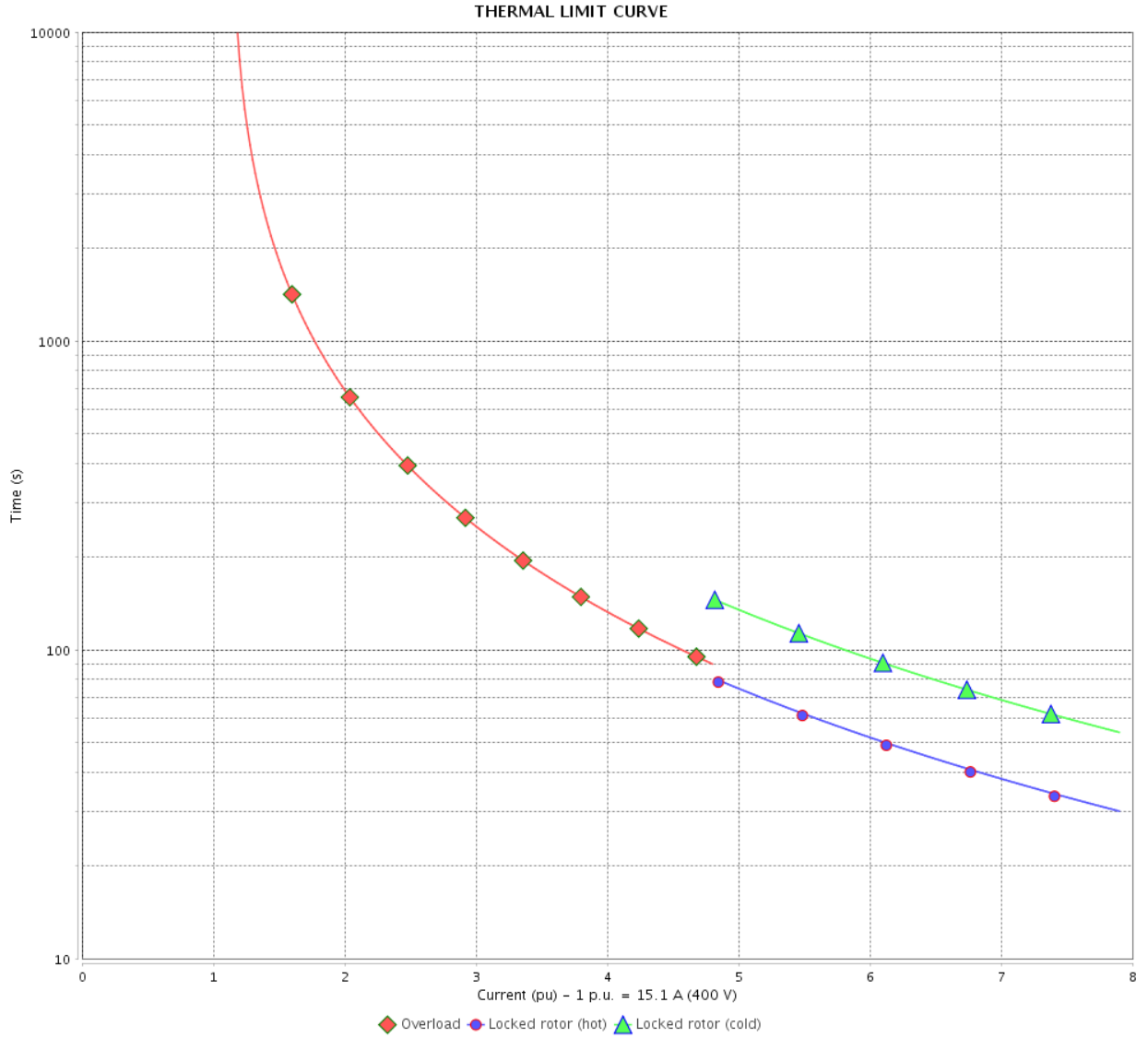

Rev.	Changes Summary	Performed	Checked	Date
Performed by		Page 21 / 36		Revision
Checked by				
Date				

THERMAL LIMIT CURVE

Three Phase Induction Motor - Squirrel Cage



Customer :

Product line : NEMA Premium Efficiency Three-Phase

Product code : 12424291

Catalog # : 01512ST3QIE284TC-W22

Performance : 415 V 50 Hz 6P IE3

Rated current	: 14.9 A	Moment of inertia (J)	: 7.85 sq.ft.lb
LRC	: 8.3	Duty cycle	: Cont.(S1)
Rated torque	: 53.3 ft.lb	Insulation class	: F
Locked rotor torque	: 330 %	Service factor	: 1.25
Breakdown torque	: 360 %	Temperature rise	: 80 K
Rated speed	: 985 rpm	Design	: B

Heating constant

Cooling constant

Rev.	Changes Summary	Performed	Checked	Date
Performed by				
Checked by			Page	Revision
Date	13/04/2022		22 / 36	

THERMAL LIMIT CURVE

Three Phase Induction Motor - Squirrel Cage



Customer : _____

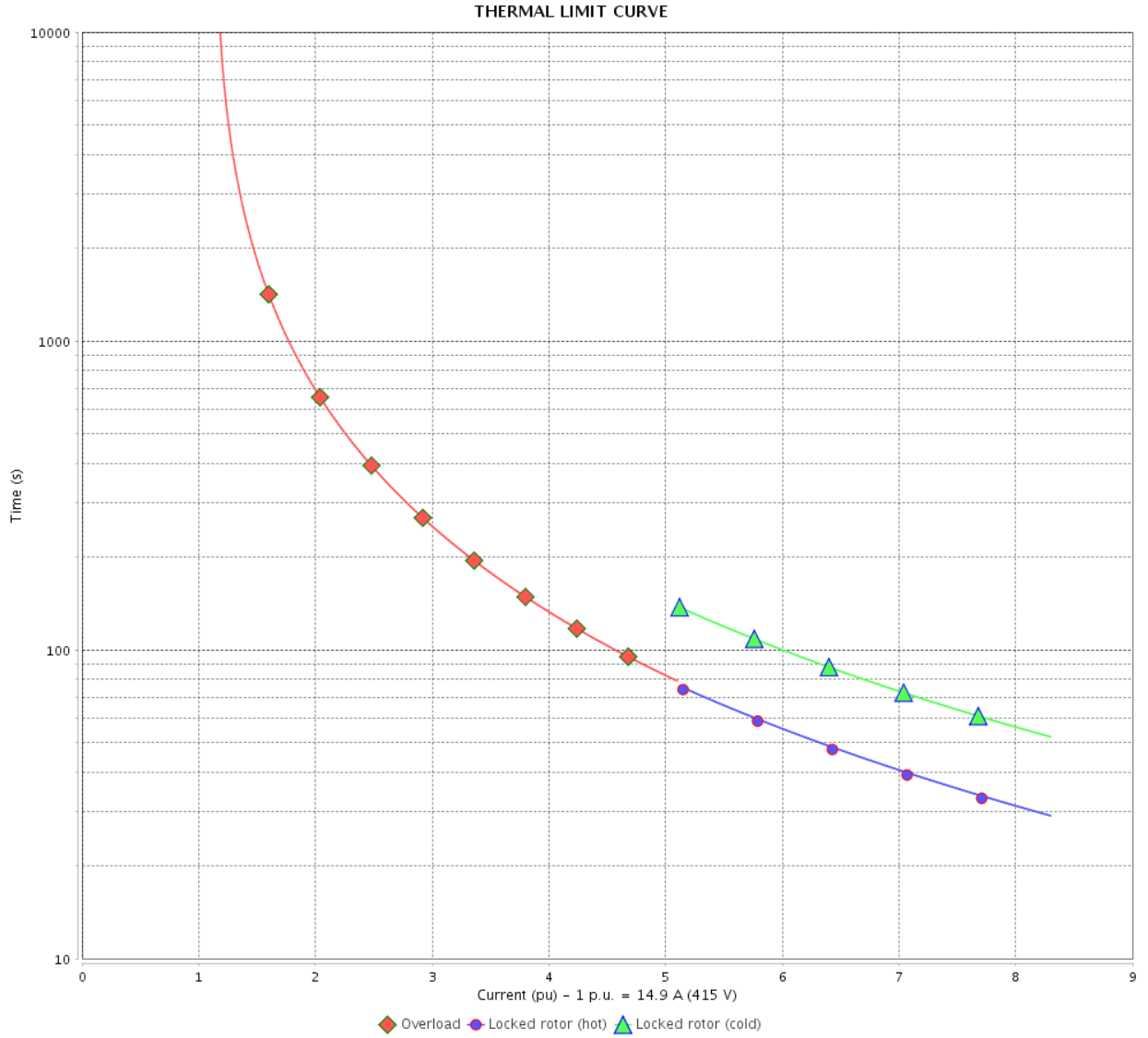

Rev.	Changes Summary	Performed	Checked	Date
Performed by		Page 23 / 36		Revision
Checked by				
Date				

THERMAL LIMIT CURVE

Three Phase Induction Motor - Squirrel Cage



Customer :

Product line : NEMA Premium Efficiency Three-Phase
Product code : 12424291
Catalog # : 01512ST3QIE284TC-W22

Performance : 380 V 50 Hz 6P IE1

Rated current	: 22.0 A	Moment of inertia (J)	: 7.85 sq.ft.lb
LRC	: 4.7	Duty cycle	: Cont.(S1)
Rated torque	: 81.6 ft.lb	Insulation class	: F
Locked rotor torque	: 170 %	Service factor	: 1.00
Breakdown torque	: 210 %	Temperature rise	: 80 K
Rated speed	: 965 rpm	Design	: B

Heating constant

Cooling constant

Rev.	Changes Summary	Performed	Checked	Date
Performed by				
Checked by			Page	Revision
Date	13/04/2022		24 / 36	

THERMAL LIMIT CURVE

Three Phase Induction Motor - Squirrel Cage



Customer : _____

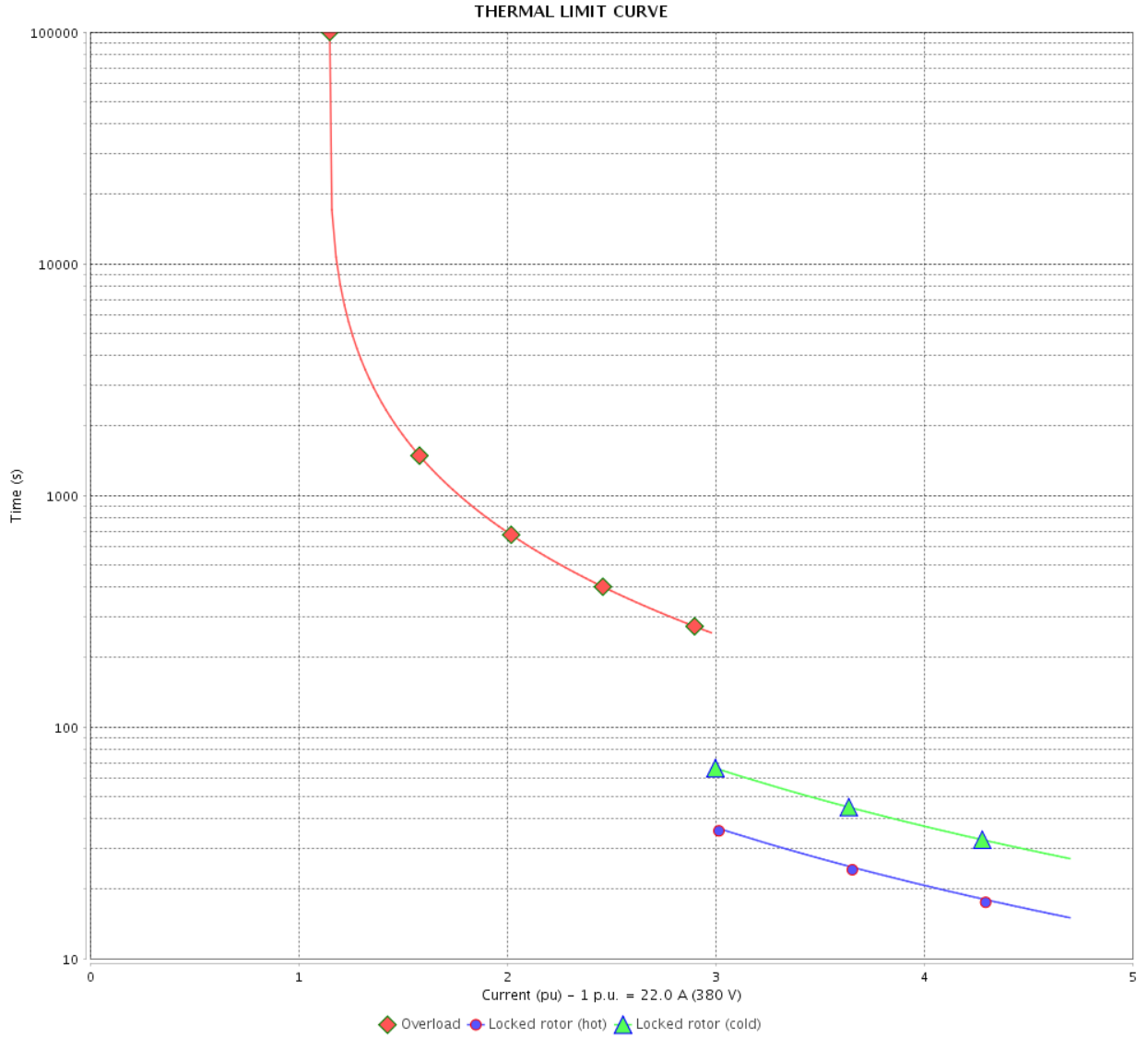

Rev.	Changes Summary	Performed	Checked	Date
Performed by		Page		Revision
Checked by		25 / 36		
Date		13/04/2022		

THERMAL LIMIT CURVE



Three Phase Induction Motor - Squirrel Cage

Customer :

Product line : NEMA Premium Efficiency Three-Phase
Product code : 12424291
Catalog # : 01512ST3QIE284TC-W22

Performance : 400 V 50 Hz 6P IE2

Rated current	: 20.9 A	Moment of inertia (J)	: 7.85 sq.ft.lb
LRC	: 5.3	Duty cycle	: Cont.(S1)
Rated torque	: 81.2 ft.lb	Insulation class	: F
Locked rotor torque	: 200 %	Service factor	: 1.15
Breakdown torque	: 229 %	Temperature rise	: 80 K
Rated speed	: 970 rpm	Design	: B

Heating constant

Cooling constant

Rev.	Changes Summary	Performed	Checked	Date
Performed by				
Checked by				
Date	13/04/2022		Page 26 / 36	Revision

THERMAL LIMIT CURVE

Three Phase Induction Motor - Squirrel Cage



Customer : _____

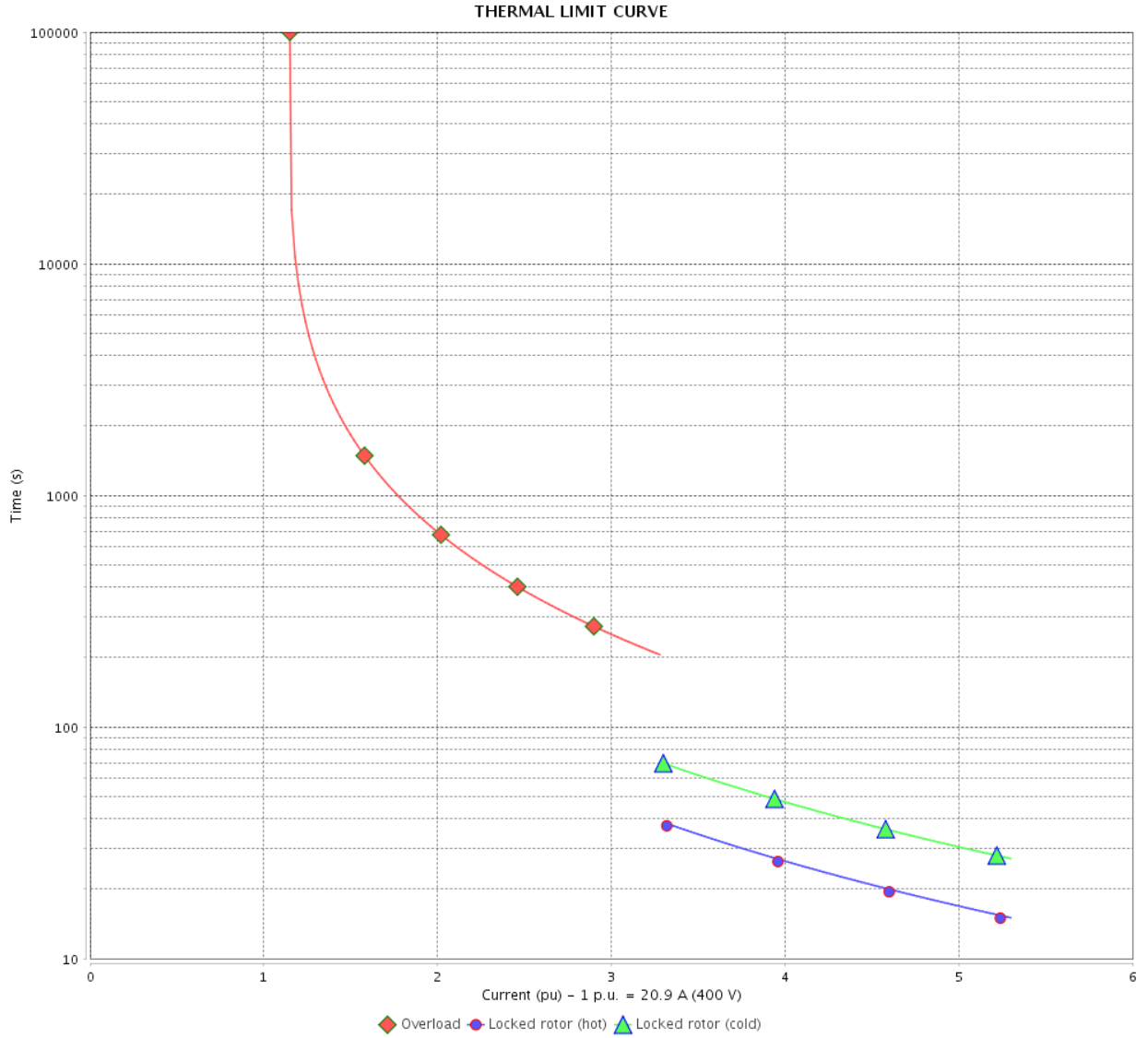

Rev.	Changes Summary	Performed	Checked	Date
Performed by		Page 27 / 36		Revision
Checked by				
Date				

THERMAL LIMIT CURVE



Three Phase Induction Motor - Squirrel Cage

Customer :

Product line : NEMA Premium Efficiency Three-Phase

Product code : 12424291

Catalog # : 01512ST3QIE284TC-W22

Performance : 415 V 50 Hz 6P IE2

Rated current	: 20.2 A	Moment of inertia (J)	: 7.85 sq.ft.lb
LRC	: 5.7	Duty cycle	: Cont.(S1)
Rated torque	: 80.8 ft.lb	Insulation class	: F
Locked rotor torque	: 220 %	Service factor	: 1.15
Breakdown torque	: 250 %	Temperature rise	: 80 K
Rated speed	: 975 rpm	Design	: B

Heating constant

Cooling constant

Rev.	Changes Summary	Performed	Checked	Date
Performed by				
Checked by			Page	Revision
Date	13/04/2022		28 / 36	

THERMAL LIMIT CURVE

Three Phase Induction Motor - Squirrel Cage



Customer : _____

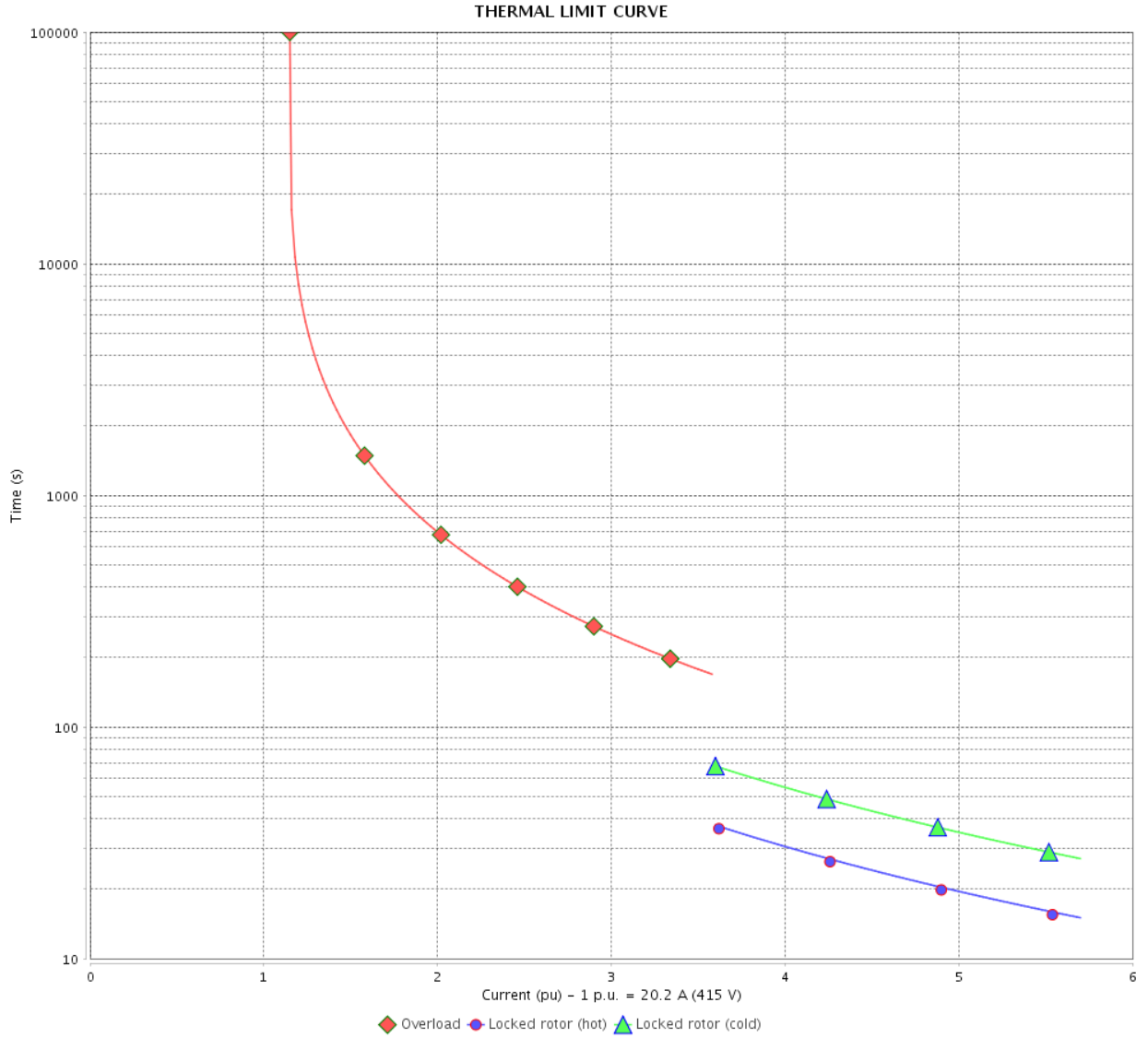

Rev.	Changes Summary	Performed	Checked	Date
Performed by		Page 29 / 36		Revision
Checked by				
Date				

VFD OPERATION CURVE

Three Phase Induction Motor - Squirrel Cage



Customer :

Product line : NEMA Premium Efficiency Three-Phase

Product code : 12424291

Catalog # : 01512ST3QIE284TC-W22

VFD OPERATION CURVE

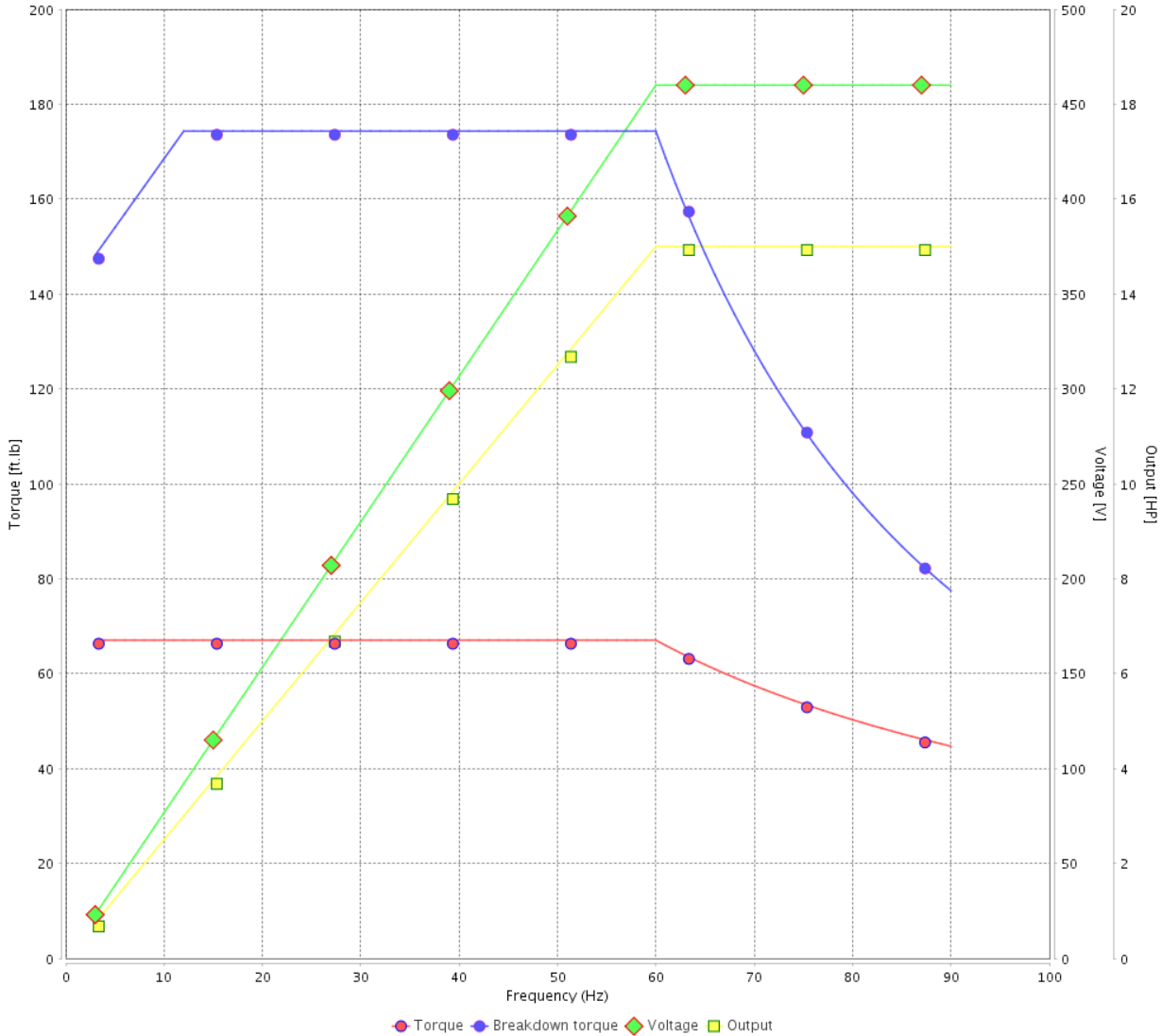

Performance : 460 V 60 Hz 6P

Rated current : 17.9 A
 LRC : 6.4
 Rated torque : 67.0 ft.lb
 Locked rotor torque : 229 %
 Breakdown torque : 260 %
 Rated speed : 1175 rpm

Moment of inertia (J) : 7.85 sq.ft.lb
 Duty cycle : Cont.(S1)
 Insulation class : F
 Service factor : 1.25
 Temperature rise : 80 K
 Design : B

Rev.	Changes Summary	Performed	Checked	Date
Performed by			Page	Revision
Checked by				
Date				

VFD OPERATION CURVE

Three Phase Induction Motor - Squirrel Cage



Customer :

Product line : NEMA Premium Efficiency Three-Phase

Product code : 12424291

Catalog # : 01512ST3QIE284TC-W22

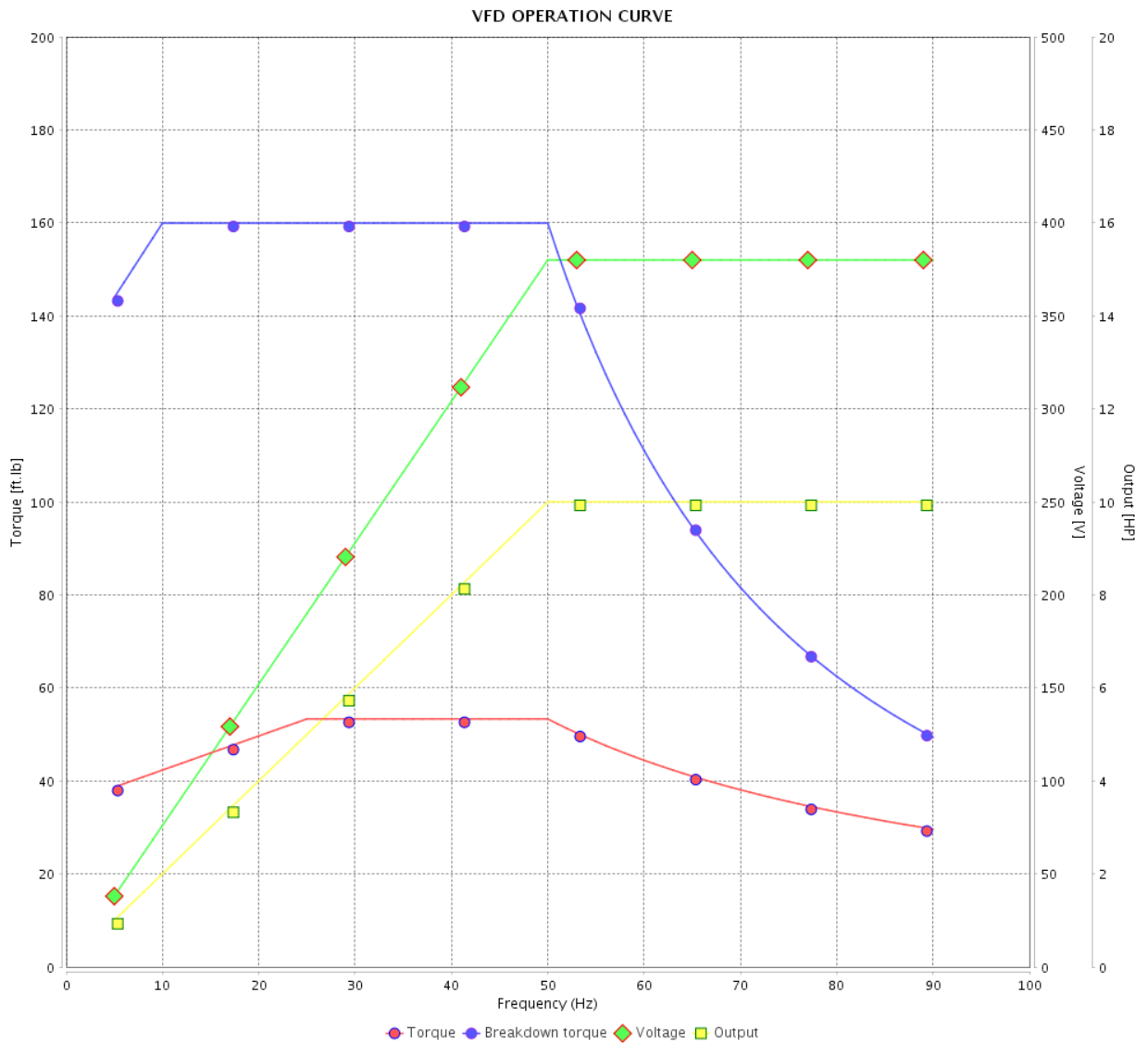

Performance : 380 V 50 Hz 6P IE3

Rated current : 15.5 A
 LRC : 7.2
 Rated torque : 53.3 ft.lb
 Locked rotor torque : 270 %
 Breakdown torque : 300 %
 Rated speed : 985 rpm

Moment of inertia (J) : 7.85 sq.ft.lb
 Duty cycle : Cont.(S1)
 Insulation class : F
 Service factor : 1.25
 Temperature rise : 80 K
 Design : B

Rev.	Changes Summary	Performed	Checked	Date
Performed by				Page 31 / 36
Checked by				
Date	13/04/2022			

VFD OPERATION CURVE

Three Phase Induction Motor - Squirrel Cage



Customer :

Product line : NEMA Premium Efficiency Three-Phase

Product code : 12424291

Catalog # : 01512ST3QIE284TC-W22

VFD OPERATION CURVE

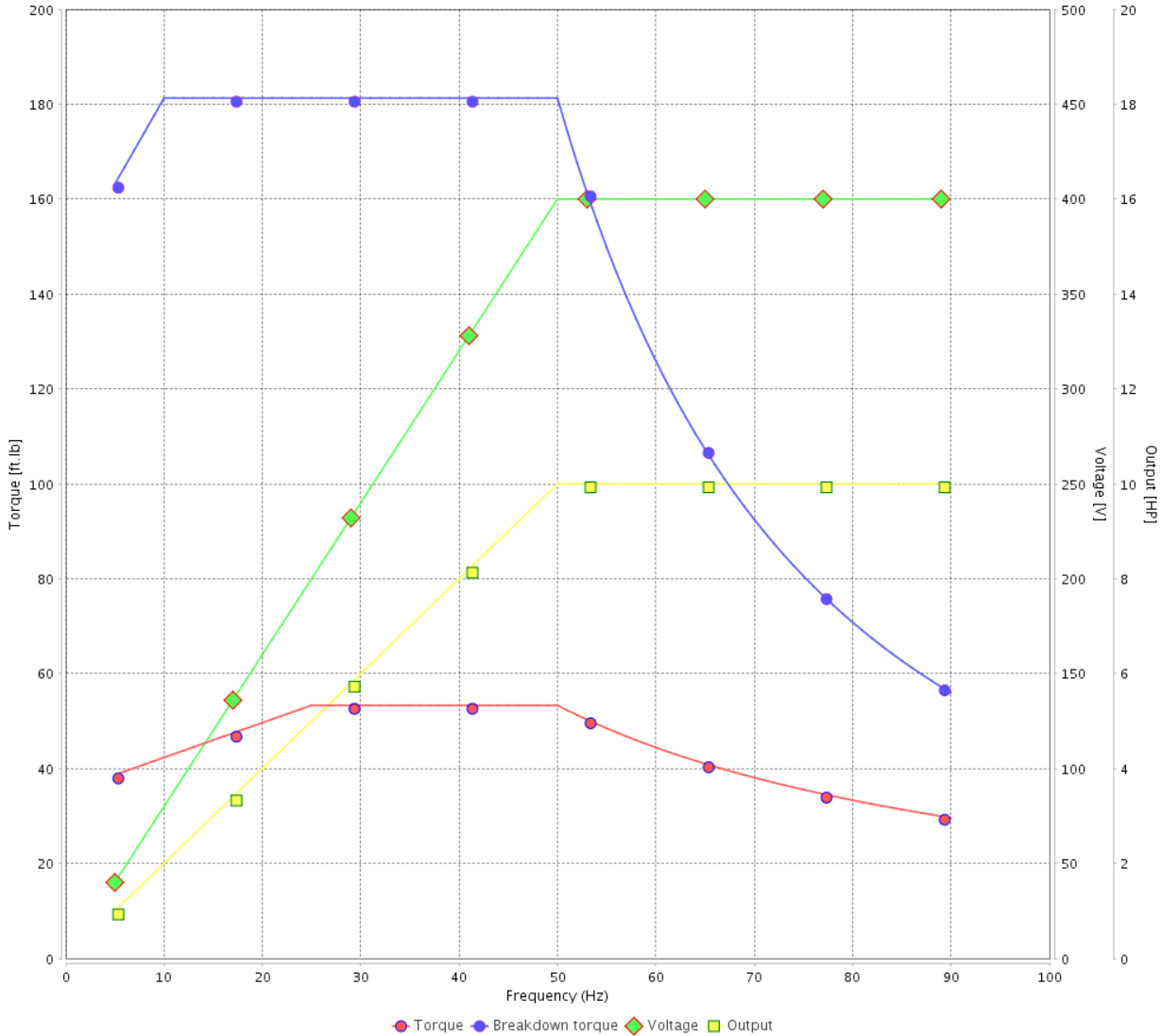

Performance : 400 V 50 Hz 6P IE3

Rated current : 15.1 A
 LRC : 7.9
 Rated torque : 53.3 ft.lb
 Locked rotor torque : 300 %
 Breakdown torque : 340 %
 Rated speed : 985 rpm

Moment of inertia (J) : 7.85 sq.ft.lb
 Duty cycle : Cont.(S1)
 Insulation class : F
 Service factor : 1.25
 Temperature rise : 80 K
 Design : B

Rev.	Changes Summary	Performed	Checked	Date
Performed by			Page 32 / 36	Revision
Checked by				
Date	13/04/2022			

VFD OPERATION CURVE

Three Phase Induction Motor - Squirrel Cage



Customer :

Product line : NEMA Premium Efficiency Three-Phase

Product code : 12424291

Catalog # : 01512ST3QIE284TC-W22

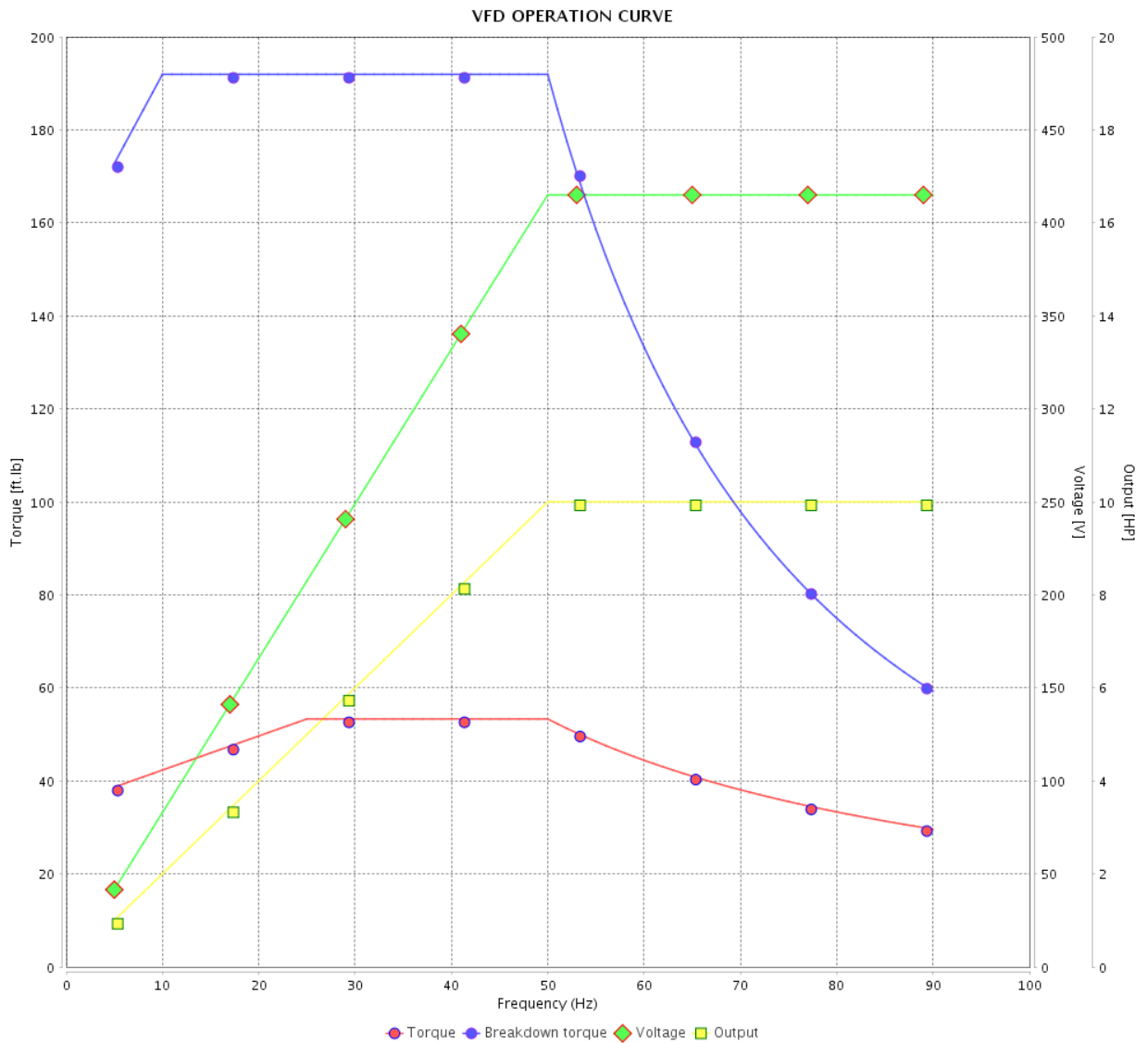

Performance : 415 V 50 Hz 6P IE3

Rated current : 14.9 A
 LRC : 8.3
 Rated torque : 53.3 ft.lb
 Locked rotor torque : 330 %
 Breakdown torque : 360 %
 Rated speed : 985 rpm

Moment of inertia (J) : 7.85 sq.ft.lb
 Duty cycle : Cont.(S1)
 Insulation class : F
 Service factor : 1.25
 Temperature rise : 80 K
 Design : B

Rev.	Changes Summary	Performed	Checked	Date
Performed by		Page		Revision
Checked by		33 / 36		
Date	13/04/2022			

VFD OPERATION CURVE

Three Phase Induction Motor - Squirrel Cage



Customer : _____

Product line : NEMA Premium Efficiency Three-Phase

Product code : 12424291

Catalog # : 01512ST3QIE284TC-W22

VFD OPERATION CURVE

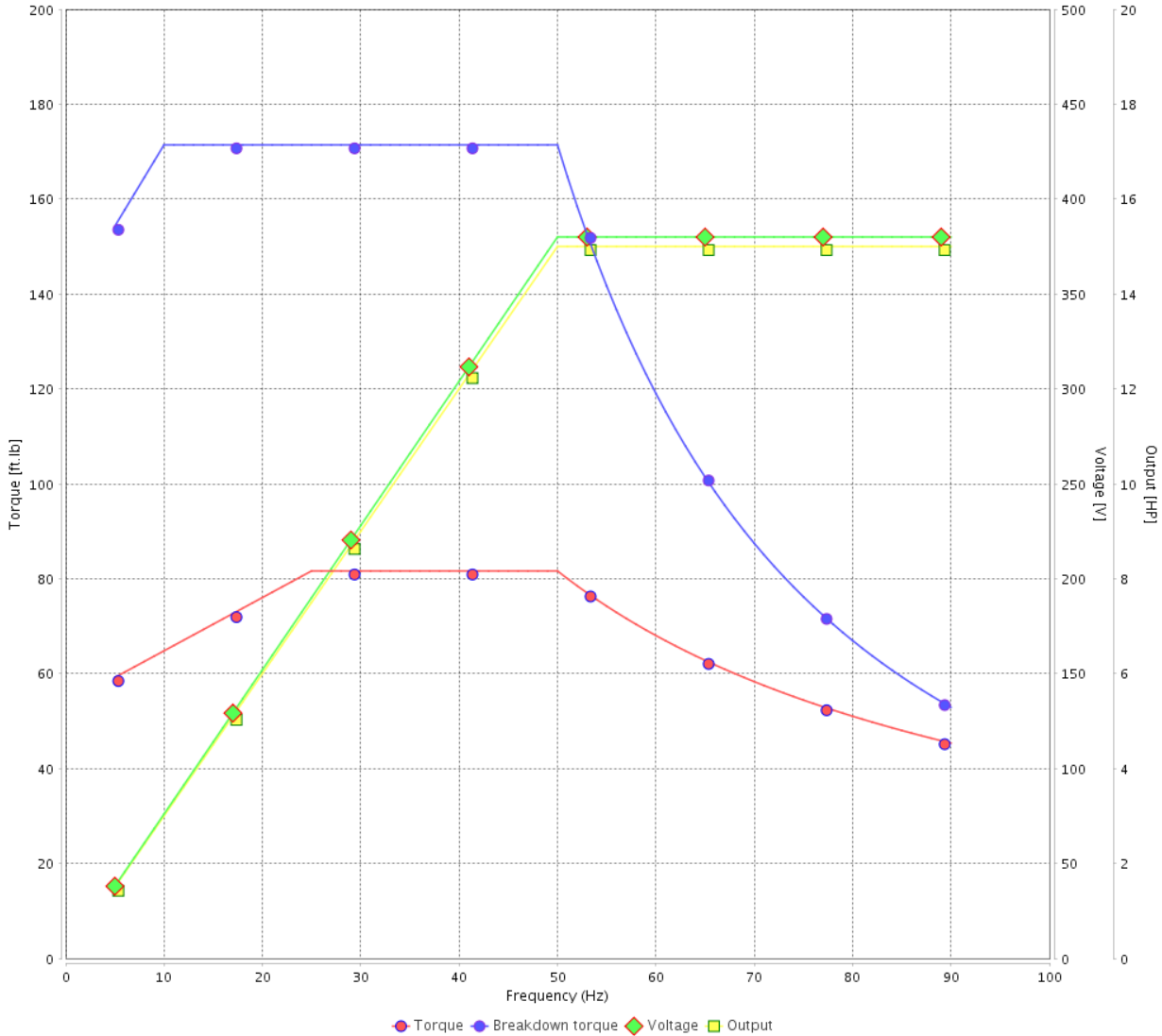

Performance : 380 V 50 Hz 6P IE1

Rated current : 22.0 A
 LRC : 4.7
 Rated torque : 81.6 ft.lb
 Locked rotor torque : 170 %
 Breakdown torque : 210 %
 Rated speed : 965 rpm

Moment of inertia (J) : 7.85 sq.ft.lb
 Duty cycle : Cont.(S1)
 Insulation class : F
 Service factor : 1.00
 Temperature rise : 80 K
 Design : B

Rev.	Changes Summary	Performed	Checked	Date
Performed by			Page 34 / 36	Revision
Checked by				
Date	13/04/2022			

VFD OPERATION CURVE

Three Phase Induction Motor - Squirrel Cage



Customer :

Product line : NEMA Premium Efficiency Three-Phase

Product code : 12424291

Catalog # : 01512ST3QIE284TC-W22

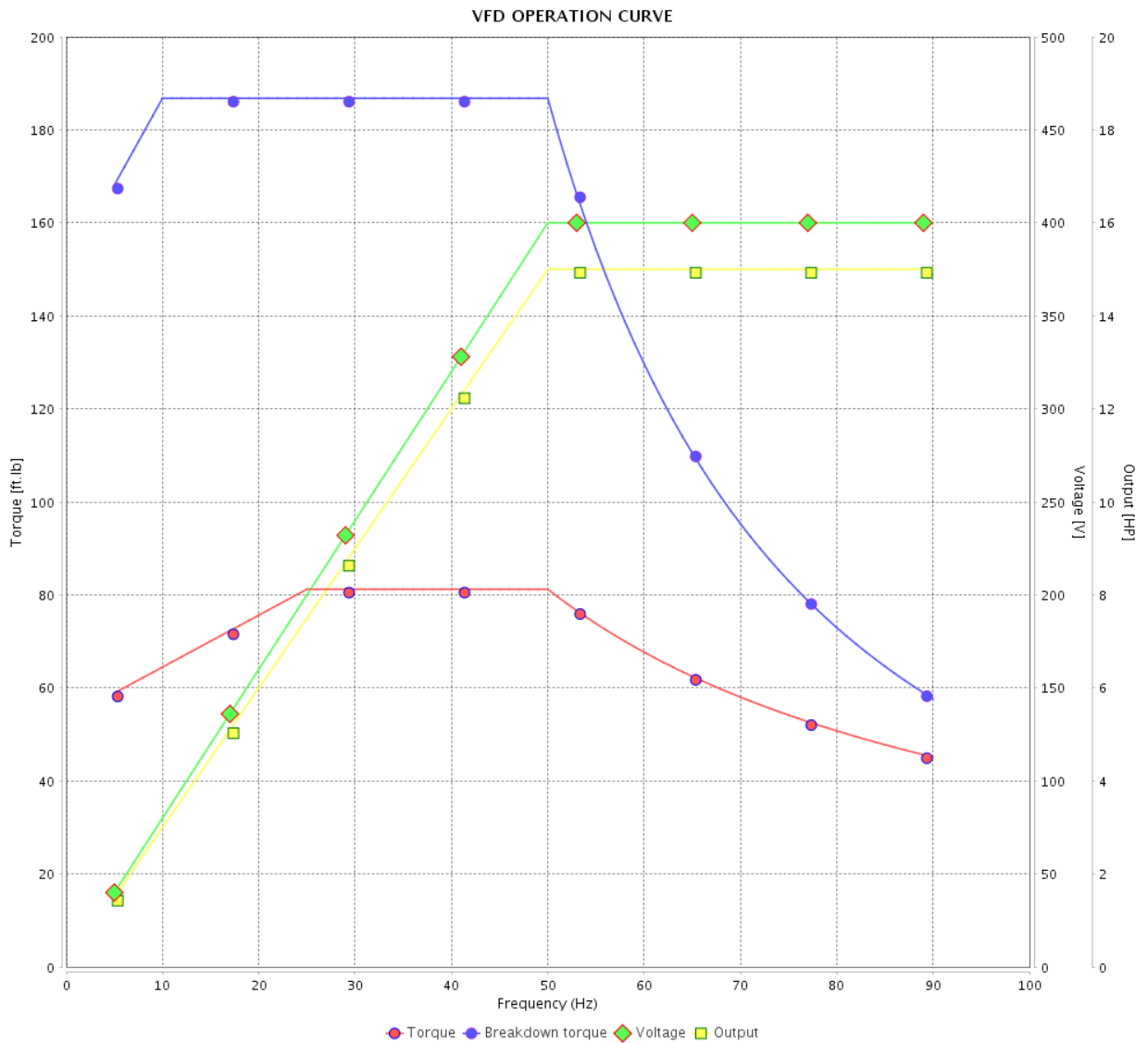

Performance : 400 V 50 Hz 6P IE2

Rated current : 20.9 A
 LRC : 5.3
 Rated torque : 81.2 ft.lb
 Locked rotor torque : 200 %
 Breakdown torque : 229 %
 Rated speed : 970 rpm

Moment of inertia (J) : 7.85 sq.ft.lb
 Duty cycle : Cont.(S1)
 Insulation class : F
 Service factor : 1.15
 Temperature rise : 80 K
 Design : B

Rev.	Changes Summary	Performed	Checked	Date
Performed by			Page	Revision
Checked by				
Date				

VFD OPERATION CURVE

Three Phase Induction Motor - Squirrel Cage



Customer :

Product line : NEMA Premium Efficiency Three-Phase

Product code : 12424291

Catalog # : 01512ST3QIE284TC-W22

VFD OPERATION CURVE

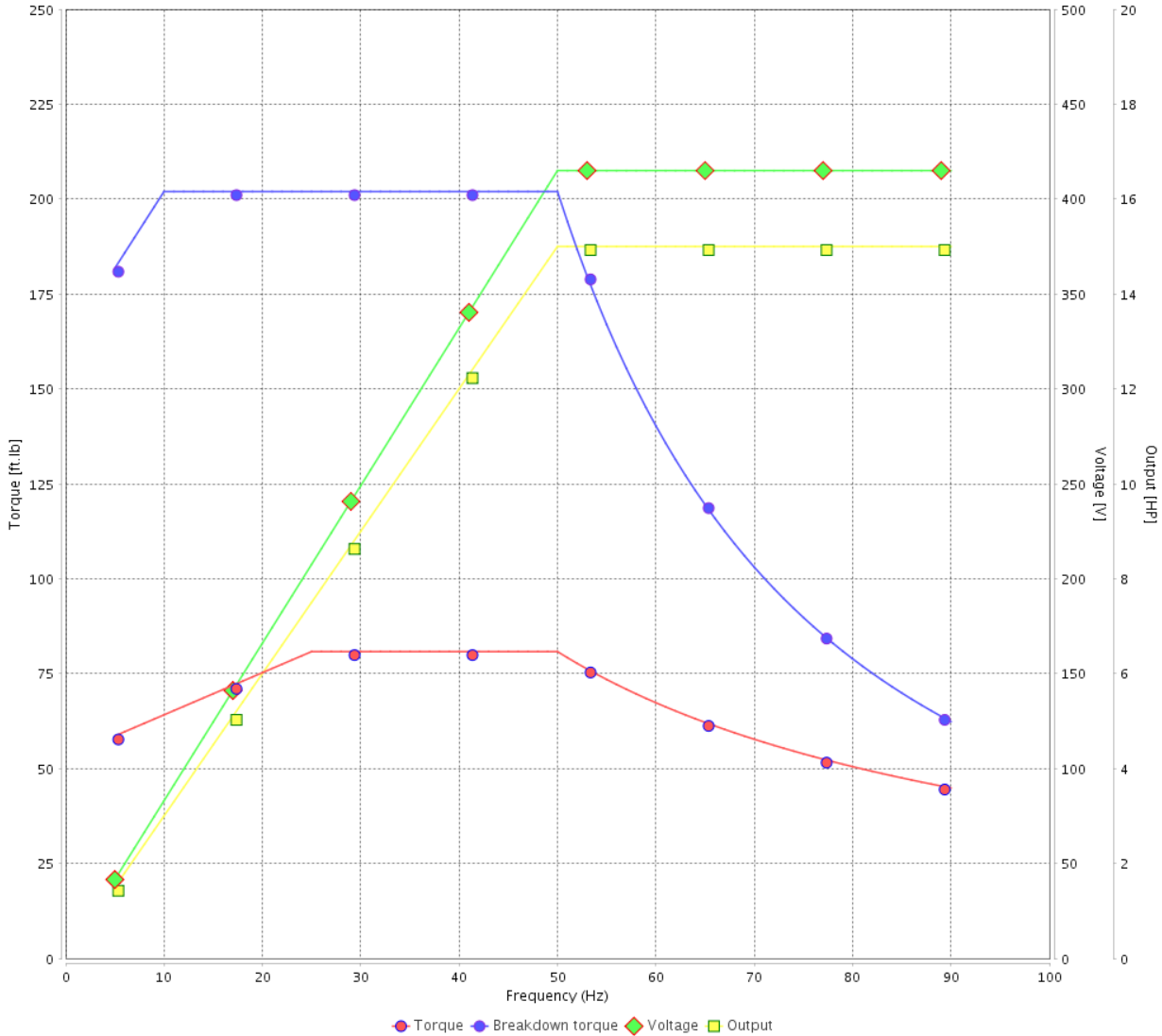

Performance : 415 V 50 Hz 6P IE2

Rated current : 20.2 A
 LRC : 5.7
 Rated torque : 80.8 ft.lb
 Locked rotor torque : 220 %
 Breakdown torque : 250 %
 Rated speed : 975 rpm

Moment of inertia (J) : 7.85 sq.ft.lb
 Duty cycle : Cont.(S1)
 Insulation class : F
 Service factor : 1.15
 Temperature rise : 80 K
 Design : B

Rev.	Changes Summary	Performed	Checked	Date
Performed by			Page	Revision
Checked by				
Date				

1 2 3 4 5 6

A

B

C

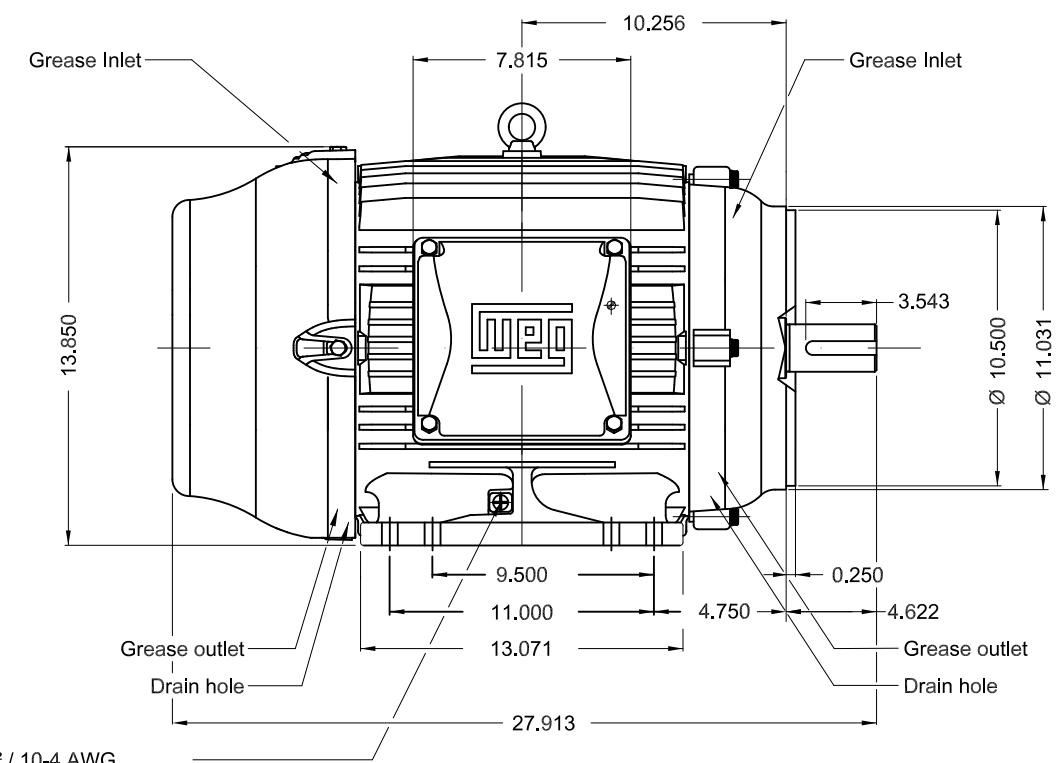
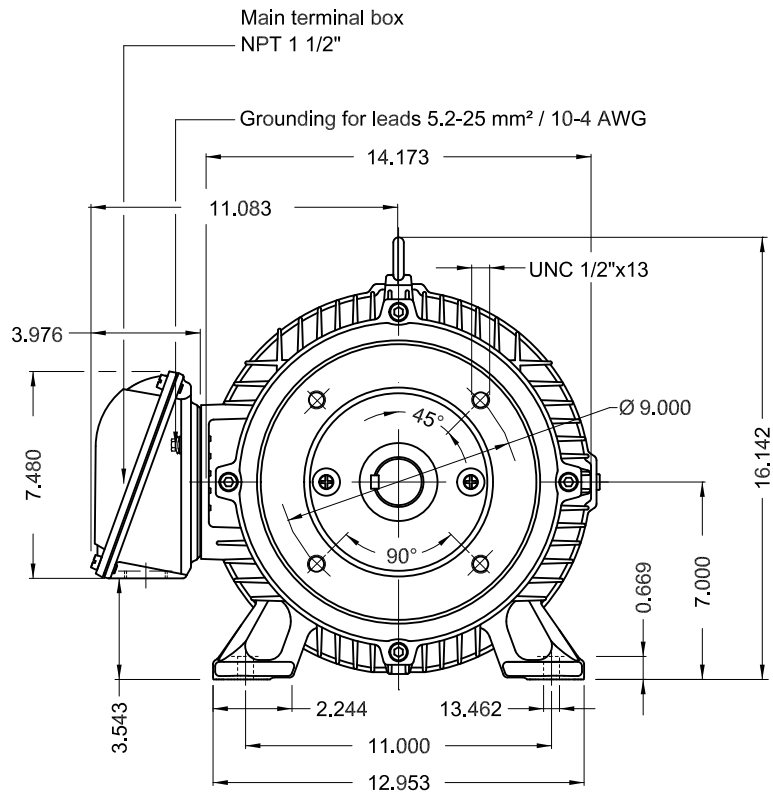

D

E

15 HP 06 Poles 60 Hz A

Color RAL 5009
 Painting plan 202E
 Mounting B34R(D)

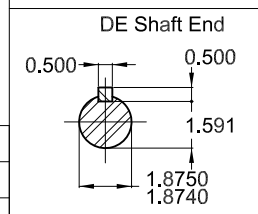

ECM	LOC	SUMMARY OF MODIFICATIONS	EXECUTED	CHECKED	RELEASED	DATE	VER
EXECUTED	PIRWBUSER	THREE PH. MOTOR IEEE 841 W22 PREM. EFF.					
CHECKED		FRAME 284/6TC IP55 TEFC					
RELEASED							
REL DT.	WMO	Jaragua do Sul	Product Engineering	SHEET	1 / 1		

PREVIEW
 WDD





NEMA
Premium
W22



FOR SAFE AREA
Mod.TE1BFOXON
CC029A



Class I, Div 2, Gr A, B, C and D - T3
Class I, Zone 2, IIC - T3
Class II, Div 2, Gr F and G - T4
For use on PWM: Gr. A, B, C, D and F,
VT 1000:1, CT 20:1, 1.00SF - T3A

MODEL 01512ST3QIE284TC-W22



Inverter Duty Motor
Severe Duty

MADE IN BRAZIL
12424291

PH3 60Hz Fr. 284/6TC 1000m.a.s.l. IP55 TEFC 430lb

V 460

A 17.9

HP 15

kW 11

SF 1.25

SFA 22.4

RPM 1175

PF 0.84

AMB 40°C

INS cl. F DT80K

NEMA NOM EFF 91.7%

DUTY CONT.

DES B Code G

GUARANT. EFF 90.2%

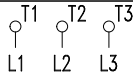

460V

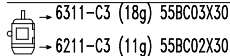

MOBIL POLYREX EM (20000h)

