

# DATA SHEET



## Three Phase Induction Motor - Squirrel Cage

Customer							
Product line	: NEMA Premium Efficiency Three-Phase	Product code	: 12385114				
		Catalog #	: 01518ST3QIE254TC-W22				
Frame	: 254/6TC	Cooling method	: IC411 - TEFC				
Insulation class	: F	Mounting	: F-1				
Duty cycle	: Cont.(S1)	Rotation <sup>1</sup>	: Both (CW and CCW)				
Ambient temperature	: -20°C to +40°C	Starting method	: Direct On Line				
Altitude	: 1000 m.a.s.l.	Approx. weight <sup>2</sup>	: 299 lb				
Protection degree	: IP55	Moment of inertia (J)	: 2.62 sq.ft.lb				
Design	: B						
Output [HP]	15	10	10	10	15	15	15
Poles	4	4	4	4	4	4	4
Frequency [Hz]	60	50	50	50	50	50	50
Rated voltage [V]	460	380	400	415	380	400	415
Rated current [A]	18.0	15.2	14.8	14.5	21.5	20.5	20.0
L. R. Amperes [A]	115	109	115	120	105	111	118
LRC [A]	6.4x(Code G)	7.2x(Code J)	7.8x(Code J)	8.3x(Code K)	4.9x(Code E)	5.4x(Code F)	5.9x(Code G)
No load current [A]	7.00	6.70	7.10	7.40	7.10	7.60	7.40
Rated speed [RPM]	1768	1475	1480	1480	1455	1460	1465
Slip [%]	1.78	1.67	1.33	1.33	3.00	2.67	2.33
Rated torque [ft.lb]	44.6	35.6	35.5	35.5	54.1	54.0	53.8
Locked rotor torque [%]	240	250	280	310	160	200	210
Breakdown torque [%]	260	300	340	370	200	220	240
Service factor	1.25	1.25	1.25	1.25	1.00	1.00	1.00
Temperature rise	80 K	80 K	80 K	80 K	80 K	80 K	80 K
Locked rotor time	55s (cold) 31s (hot)	72s (cold) 40s (hot)	63s (cold) 35s (hot)	57s (cold) 32s (hot)	41s (cold) 23s (hot)	41s (cold) 23s (hot)	37s (cold) 21s (hot)
Noise level <sup>2</sup>	64.0 dB(A)	61.0 dB(A)	61.0 dB(A)	61.0 dB(A)	61.0 dB(A)	61.0 dB(A)	61.0 dB(A)
Efficiency (%)	25%						
	50%	91.0	88.8	88.6	88.3	91.0	91.0
	75%	91.7	90.3	90.3	90.3	90.2	91.0
	100%	92.4	90.4	90.6	90.8	90.2	91.0
Power Factor	25%						
	50%	0.68	0.65	0.62	0.59	0.74	0.69
	75%	0.78	0.77	0.74	0.72	0.82	0.79
	100%	0.83	0.83	0.81	0.79	0.86	0.84
Bearing type	: Drive end : 6309 C3	Non drive end : 6209 C3	Foundation loads				
Sealing	: Inpro/Seal	Inpro/Seal	Max. traction	: 469 lb			
Lubrication interval	: 20000 h	20000 h	Max. compression	: 769 lb			
Lubricant amount	: 13 g	9 g					
Lubricant type	: Mobil Polyrex EM						
Notes							
This revision replaces and cancel the previous one, which must be eliminated. (1) Looking the motor from the shaft end. (2) Measured at 1m and with tolerance of +3dB(A). (3) Approximate weight subject to changes after manufacturing process. (4) At 100% of full load.				These are average values based on tests with sinusoidal power supply, subject to the tolerances stipulated in NEMA MG-1.			
Rev.	Changes Summary			Performed	Checked	Date	
Performed by							
Checked by					Page	Revision	
Date	13/04/2022				1 / 36		

# TORQUE AND CURRENT VS SPEED CURVE

Three Phase Induction Motor - Squirrel Cage



Customer :

Product line : NEMA Premium Efficiency Three-Phase

Product code : 12385114

Catalog # : 01518ST3QIE254TC-W22

TORQUE AND CURRENT VS SPEED CURVE

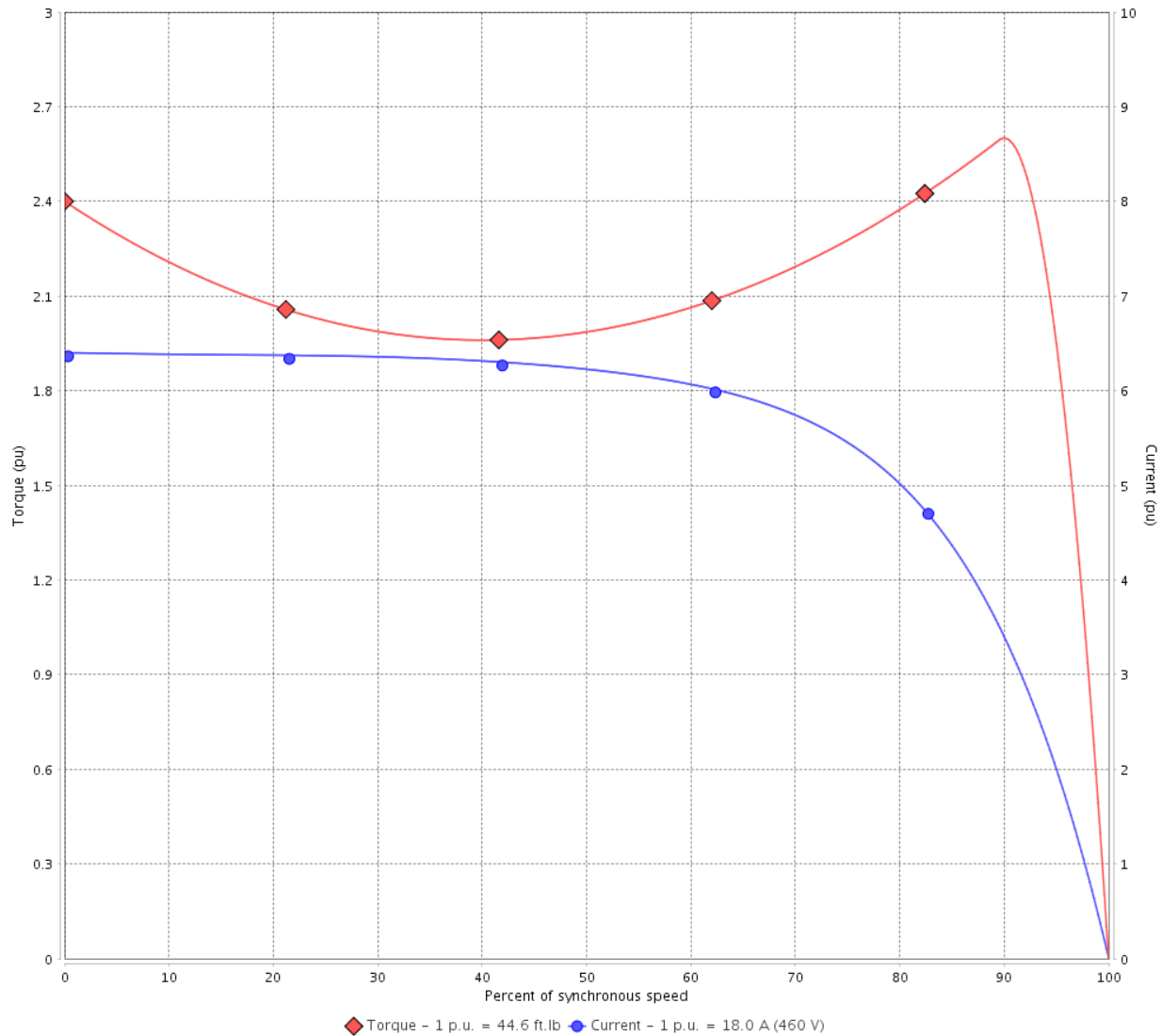

Performance : 460 V 60 Hz 4P

Rated current	: 18.0 A	Moment of inertia (J)	: 2.62 sq.ft.lb
LRC	: 6.4	Duty cycle	: Cont.(S1)
Rated torque	: 44.6 ft.lb	Insulation class	: F
Locked rotor torque	: 240 %	Service factor	: 1.25
Breakdown torque	: 260 %	Temperature rise	: 80 K
Rated speed	: 1768 rpm	Design	: B

Locked rotor time : 55s (cold) 31s (hot)

Rev.	Changes Summary	Performed	Checked	Date
Performed by			Page 2 / 36	Revision
Checked by				
Date	13/04/2022			

# TORQUE AND CURRENT VS SPEED CURVE



## Three Phase Induction Motor - Squirrel Cage

Customer :

Product line : NEMA Premium Efficiency Three-Phase

Product code : 12385114

Catalog # : 01518ST3QIE254TC-W22

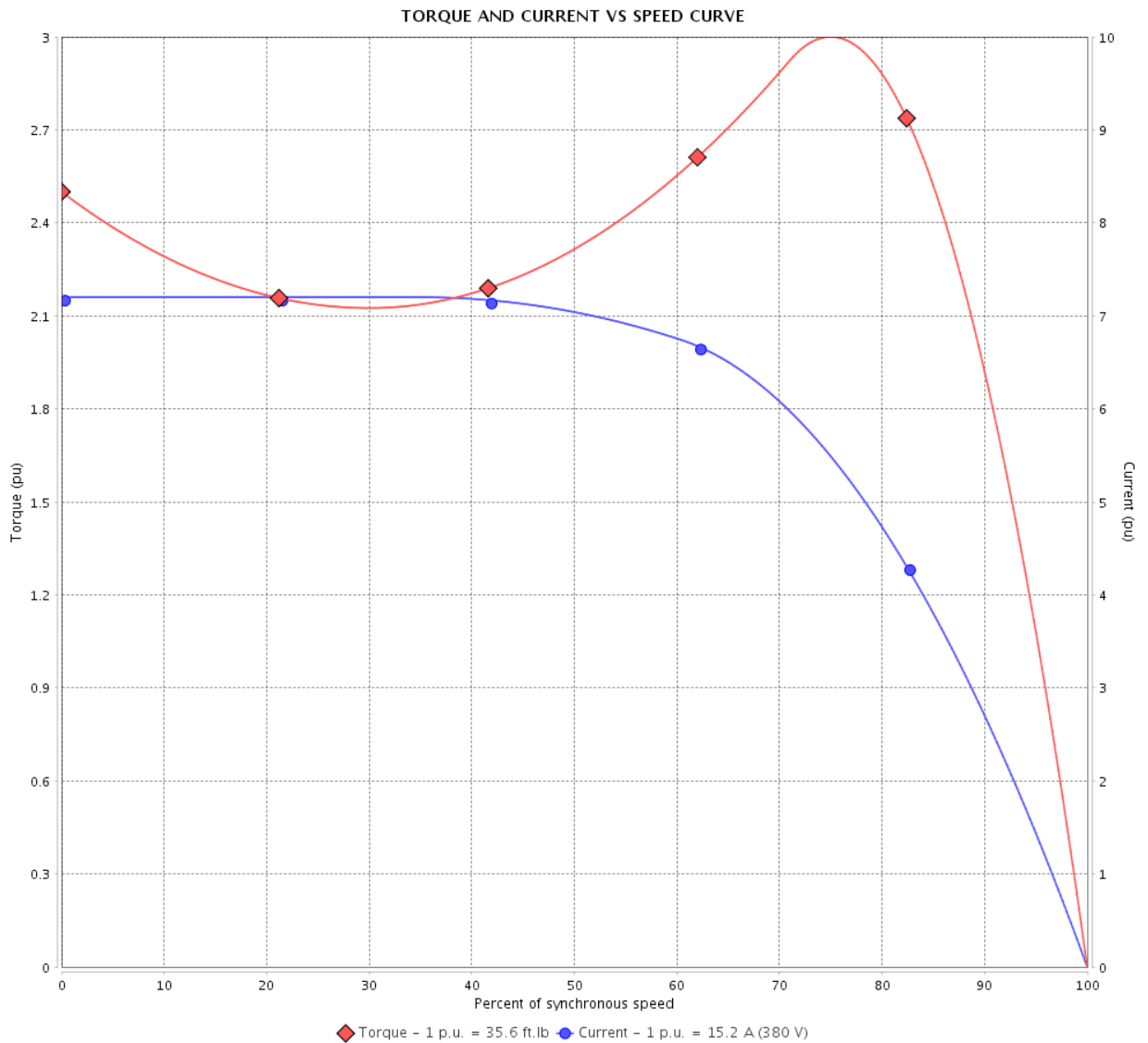

Performance : 380 V 50 Hz 4P IE3

Rated current	: 15.2 A	Moment of inertia (J)	: 2.62 sq.ft.lb
LRC	: 7.2	Duty cycle	: Cont.(S1)
Rated torque	: 35.6 ft.lb	Insulation class	: F
Locked rotor torque	: 250 %	Service factor	: 1.25
Breakdown torque	: 300 %	Temperature rise	: 80 K
Rated speed	: 1475 rpm	Design	: B

Locked rotor time : 72s (cold) 40s (hot)

Rev.	Changes Summary	Performed	Checked	Date
Performed by			Page	Revision
Checked by			3 / 36	
Date	13/04/2022			

# TORQUE AND CURRENT VS SPEED CURVE

Three Phase Induction Motor - Squirrel Cage



Customer :

Product line : NEMA Premium Efficiency Three-Phase

Product code : 12385114

Catalog # : 01518ST3QIE254TC-W22

TORQUE AND CURRENT VS SPEED CURVE

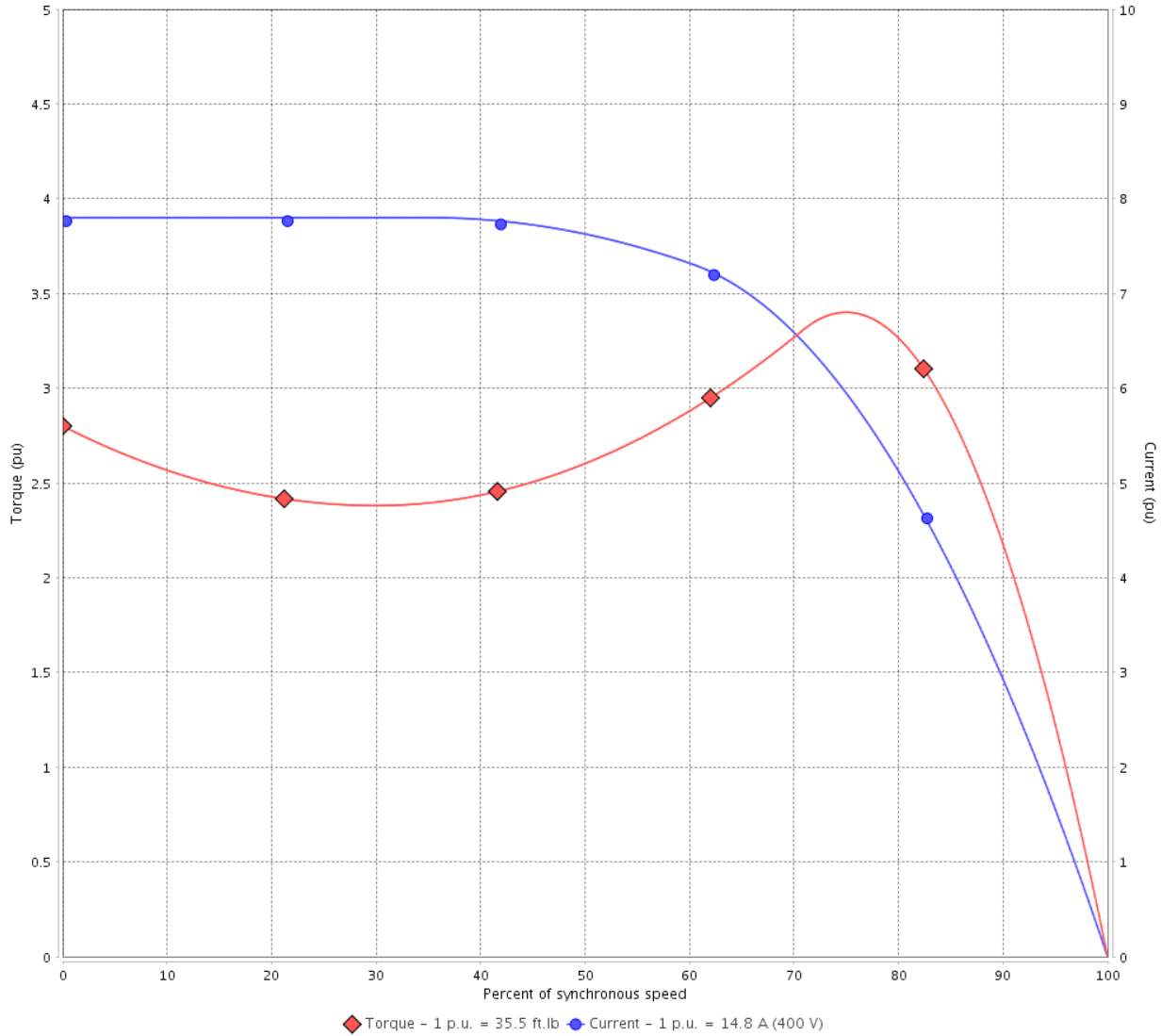

Performance : 400 V 50 Hz 4P IE3

Rated current	: 14.8 A	Moment of inertia (J)	: 2.62 sq.ft.lb
LRC	: 7.8	Duty cycle	: Cont.(S1)
Rated torque	: 35.5 ft.lb	Insulation class	: F
Locked rotor torque	: 280 %	Service factor	: 1.25
Breakdown torque	: 340 %	Temperature rise	: 80 K
Rated speed	: 1480 rpm	Design	: B

Locked rotor time : 63s (cold) 35s (hot)

Rev.	Changes Summary	Performed	Checked	Date
Performed by			Page 4 / 36	Revision
Checked by				
Date	13/04/2022			

# TORQUE AND CURRENT VS SPEED CURVE



## Three Phase Induction Motor - Squirrel Cage

Customer :

Product line : NEMA Premium Efficiency Three-Phase

Product code : 12385114

Catalog # : 01518ST3QIE254TC-W22

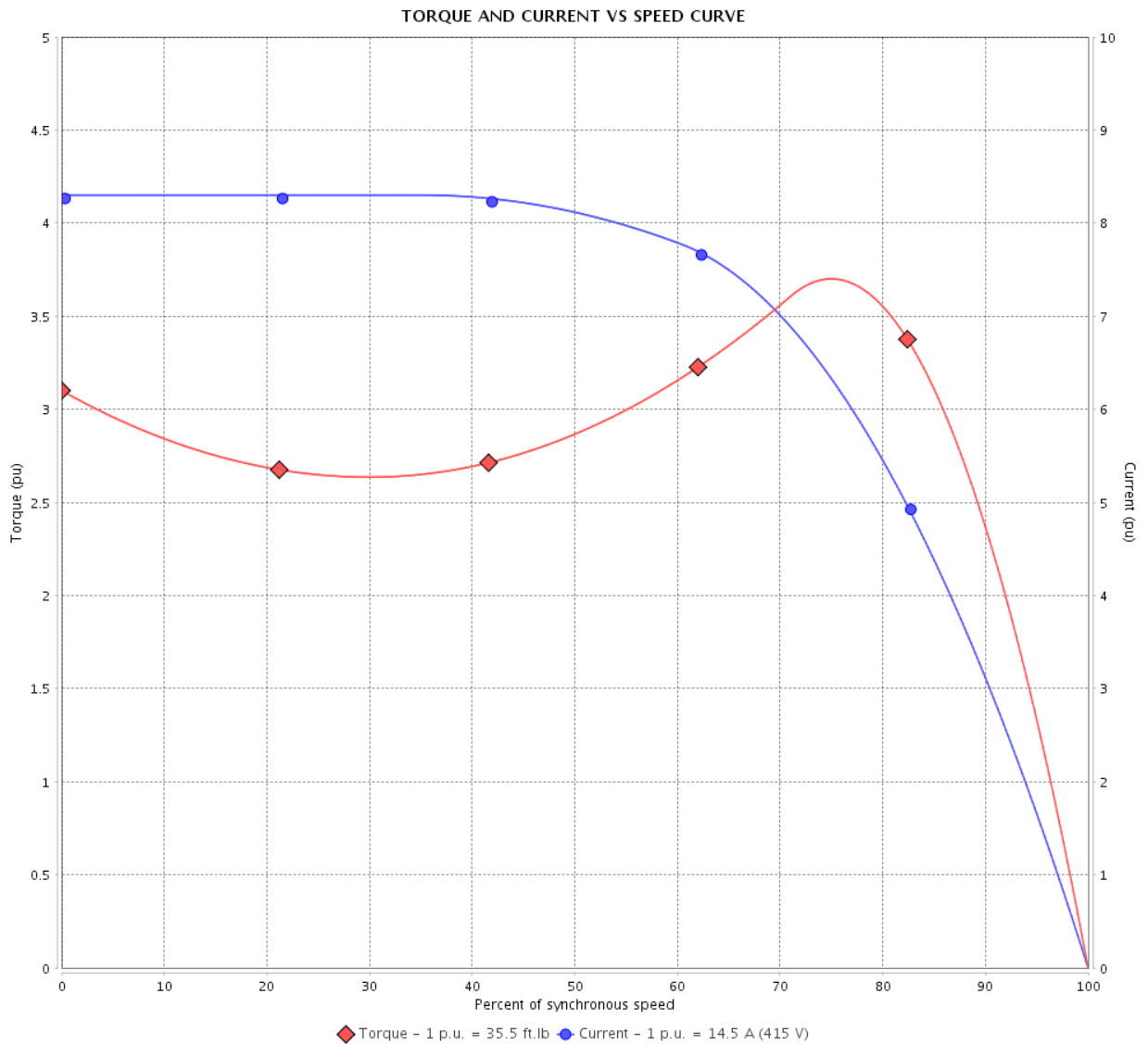

Performance : 415 V 50 Hz 4P IE3

Rated current	: 14.5 A	Moment of inertia (J)	: 2.62 sq.ft.lb
LRC	: 8.3	Duty cycle	: Cont.(S1)
Rated torque	: 35.5 ft.lb	Insulation class	: F
Locked rotor torque	: 310 %	Service factor	: 1.25
Breakdown torque	: 370 %	Temperature rise	: 80 K
Rated speed	: 1480 rpm	Design	: B

Locked rotor time : 57s (cold) 32s (hot)

Rev.	Changes Summary	Performed	Checked	Date
Performed by			Page 5 / 36	Revision
Checked by				
Date	13/04/2022			

# TORQUE AND CURRENT VS SPEED CURVE

Three Phase Induction Motor - Squirrel Cage



Customer :

Product line : NEMA Premium Efficiency Three-Phase

Product code : 12385114

Catalog # : 01518ST3QIE254TC-W22

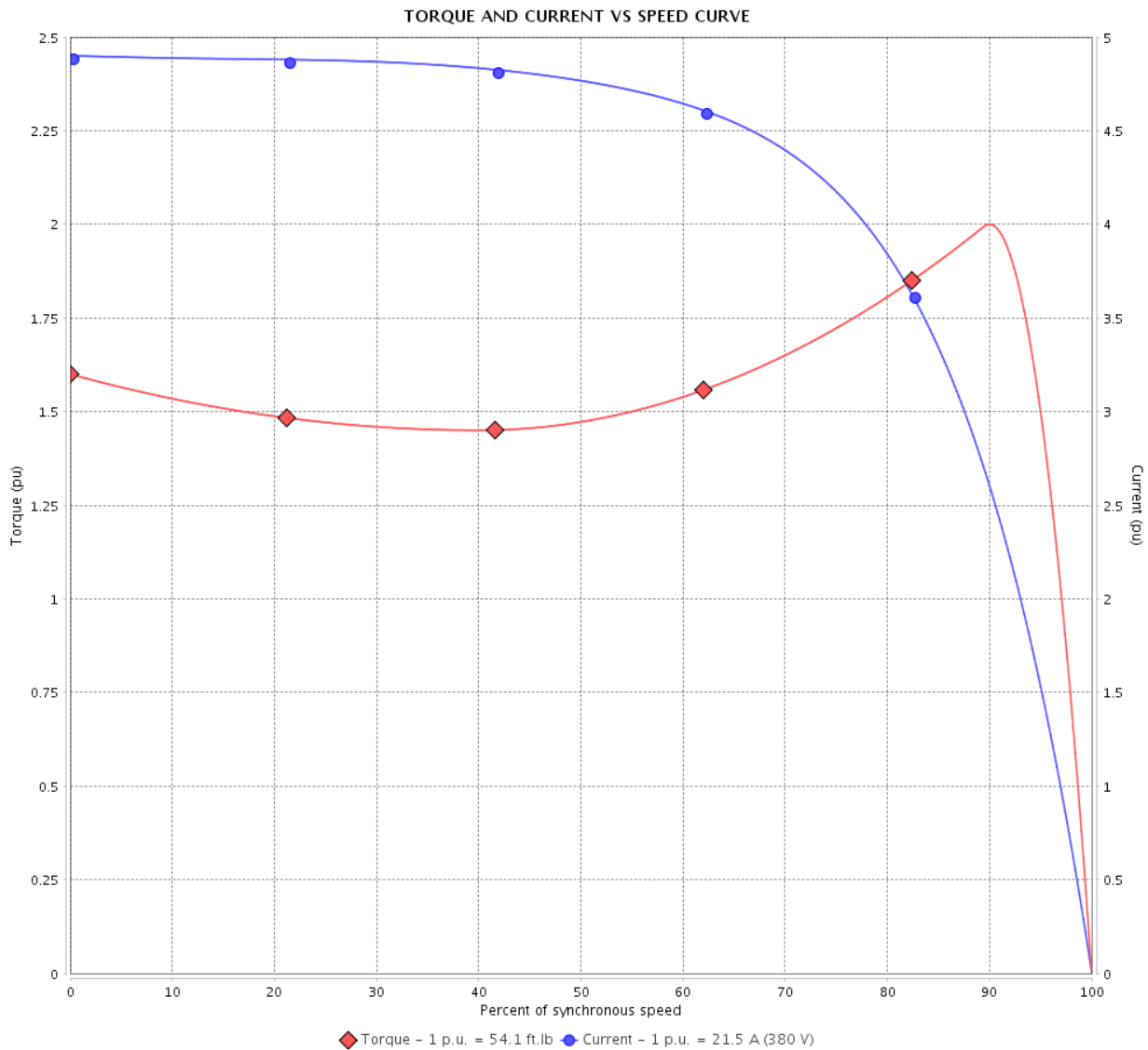

Performance : 380 V 50 Hz 4P IE2

Rated current	: 21.5 A	Moment of inertia (J)	: 2.62 sq.ft.lb
LRC	: 4.9	Duty cycle	: Cont.(S1)
Rated torque	: 54.1 ft.lb	Insulation class	: F
Locked rotor torque	: 160 %	Service factor	: 1.00
Breakdown torque	: 200 %	Temperature rise	: 80 K
Rated speed	: 1455 rpm	Design	: B

Locked rotor time : 41s (cold) 23s (hot)

Rev.	Changes Summary	Performed	Checked	Date
Performed by			Page 6 / 36	Revision
Checked by				
Date	13/04/2022			

# TORQUE AND CURRENT VS SPEED CURVE



## Three Phase Induction Motor - Squirrel Cage

Customer :

Product line : NEMA Premium Efficiency Three-Phase

Product code : 12385114

Catalog # : 01518ST3QIE254TC-W22

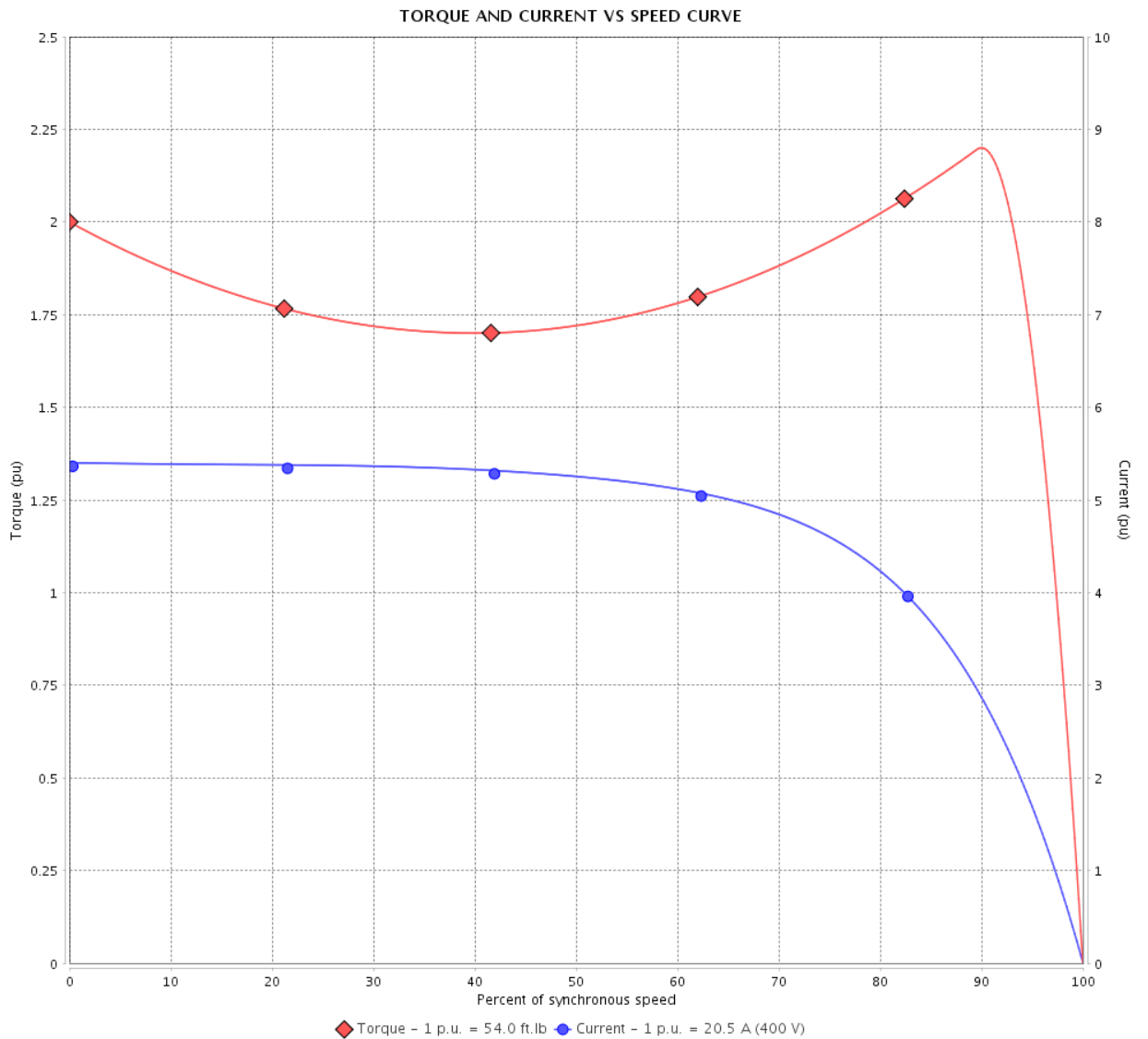

Performance : 400 V 50 Hz 4P IE2

Rated current	: 20.5 A	Moment of inertia (J)	: 2.62 sq.ft.lb
LRC	: 5.4	Duty cycle	: Cont.(S1)
Rated torque	: 54.0 ft.lb	Insulation class	: F
Locked rotor torque	: 200 %	Service factor	: 1.00
Breakdown torque	: 220 %	Temperature rise	: 80 K
Rated speed	: 1460 rpm	Design	: B

Locked rotor time : 41s (cold) 23s (hot)

Rev.	Changes Summary	Performed	Checked	Date
Performed by			Page 7 / 36	Revision
Checked by				
Date	13/04/2022			

# TORQUE AND CURRENT VS SPEED CURVE

Three Phase Induction Motor - Squirrel Cage



Customer :

Product line : NEMA Premium Efficiency Three-Phase

Product code : 12385114

Catalog # : 01518ST3QIE254TC-W22

TORQUE AND CURRENT VS SPEED CURVE

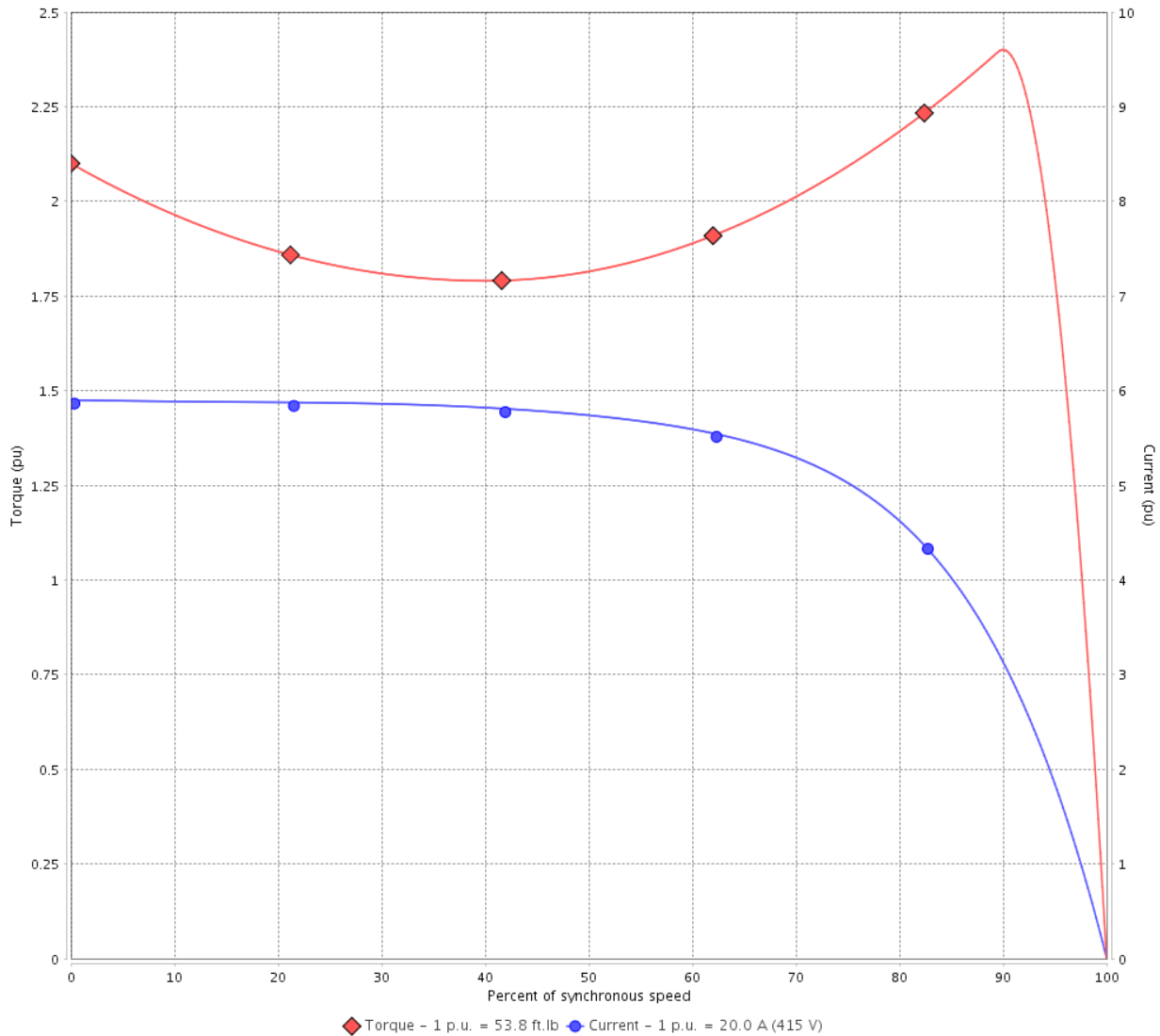

Performance : 415 V 50 Hz 4P IE2

Rated current	: 20.0 A	Moment of inertia (J)	: 2.62 sq.ft.lb
LRC	: 5.9	Duty cycle	: Cont.(S1)
Rated torque	: 53.8 ft.lb	Insulation class	: F
Locked rotor torque	: 210 %	Service factor	: 1.00
Breakdown torque	: 240 %	Temperature rise	: 80 K
Rated speed	: 1465 rpm	Design	: B

Locked rotor time : 37s (cold) 21s (hot)

Rev.	Changes Summary	Performed	Checked	Date
Performed by			Page 8 / 36	Revision
Checked by				
Date	13/04/2022			



# LOAD PERFORMANCE CURVE

## Three Phase Induction Motor - Squirrel Cage



Customer :

Product line : NEMA Premium Efficiency Three-Phase

Product code : 12385114

Catalog # : 01518ST3QIE254TC-W22

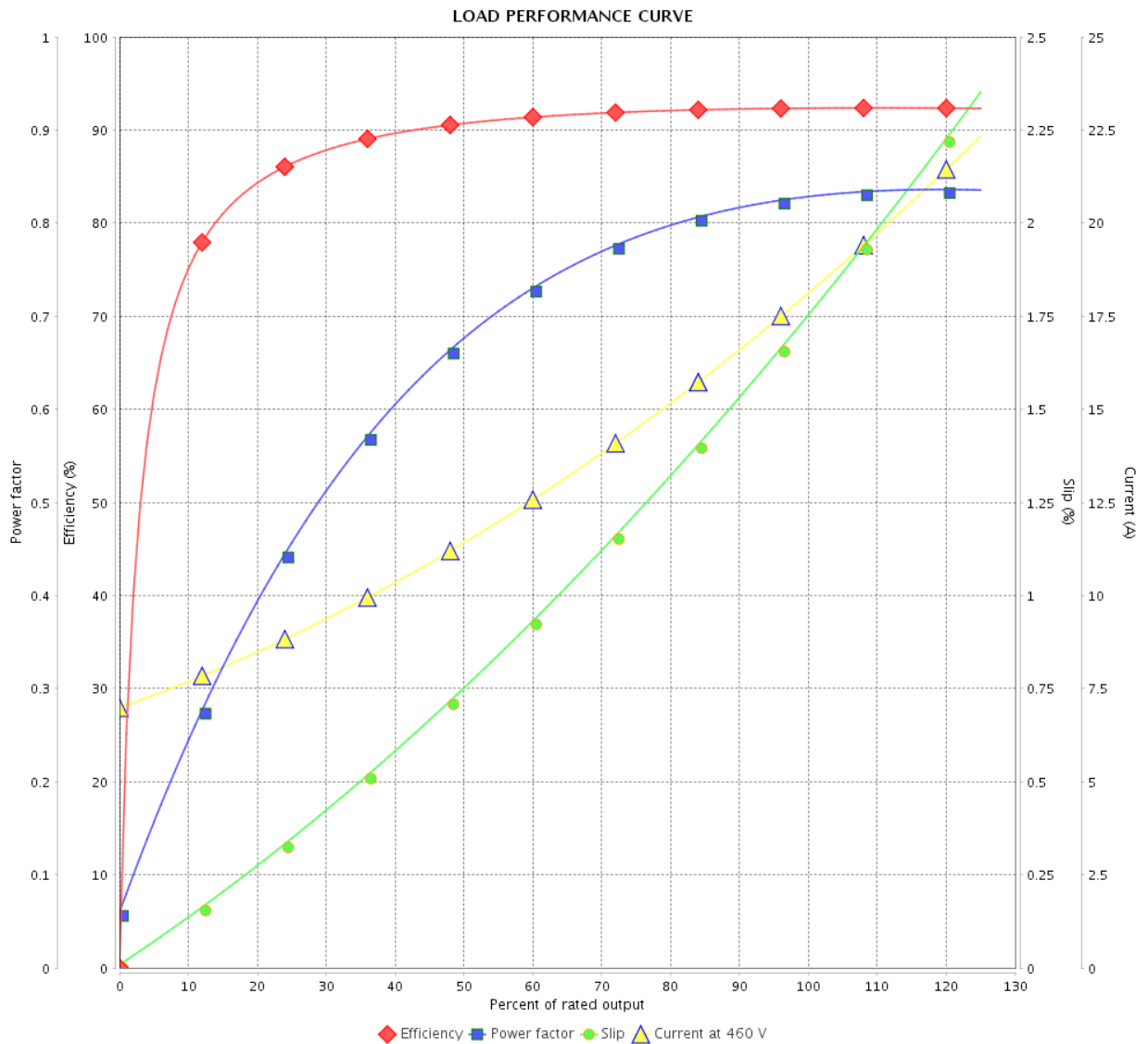

Performance : 460 V 60 Hz 4P

Rated current : 18.0 A  
 LRC : 6.4  
 Rated torque : 44.6 ft.lb  
 Locked rotor torque : 240 %  
 Breakdown torque : 260 %  
 Rated speed : 1768 rpm

Moment of inertia (J) : 2.62 sq.ft.lb  
 Duty cycle : Cont.(S1)  
 Insulation class : F  
 Service factor : 1.25  
 Temperature rise : 80 K  
 Design : B

Rev.	Changes Summary	Performed	Checked	Date
Performed by				
Checked by				
Date				
		Page	Revision	
		9 / 36		

# LOAD PERFORMANCE CURVE

Three Phase Induction Motor - Squirrel Cage



Customer :

Product line : NEMA Premium Efficiency Three-Phase

Product code : 12385114

Catalog # : 01518ST3QIE254TC-W22

LOAD PERFORMANCE CURVE

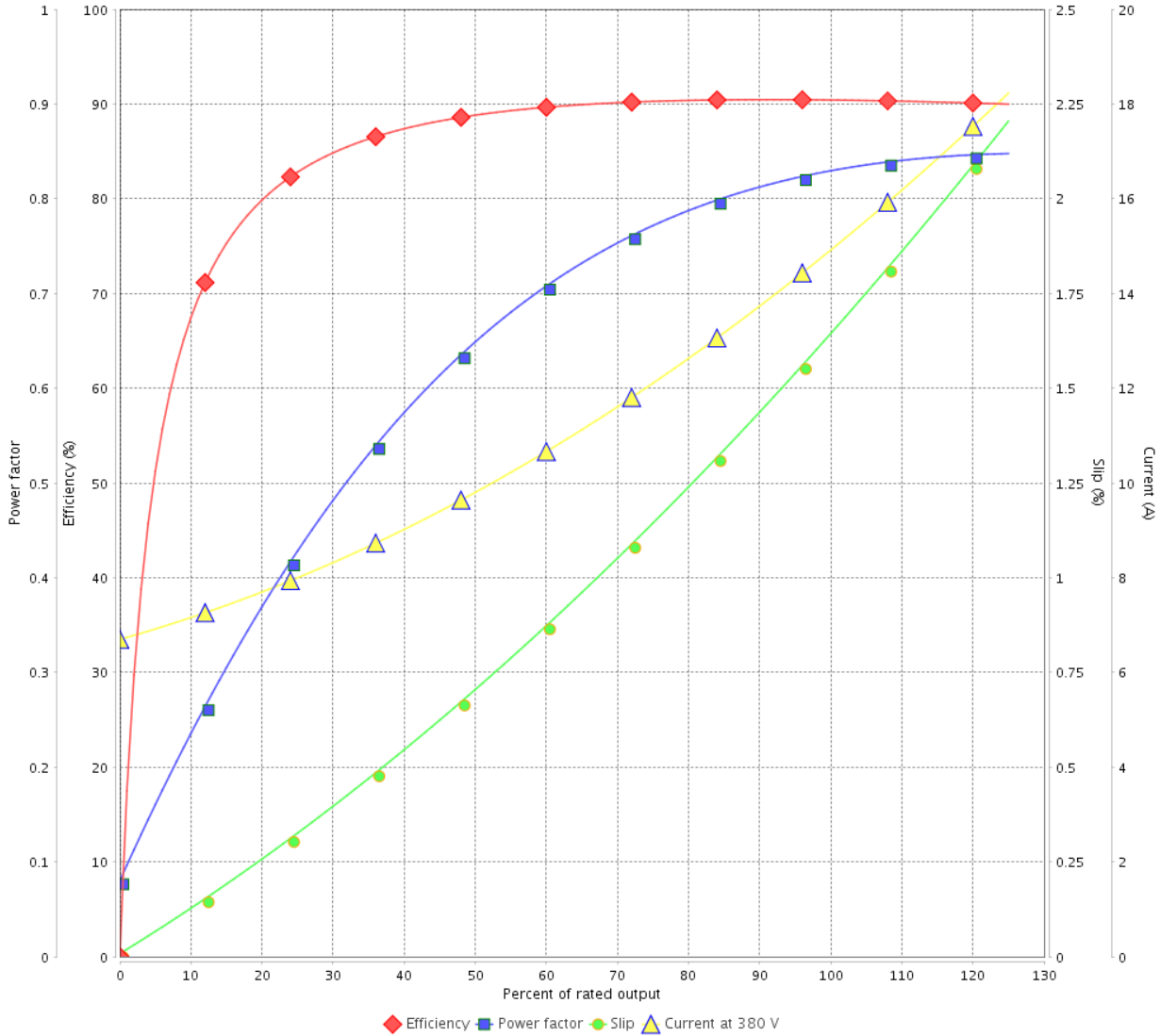

Performance : 380 V 50 Hz 4P IE3

Rated current : 15.2 A  
 LRC : 7.2  
 Rated torque : 35.6 ft.lb  
 Locked rotor torque : 250 %  
 Breakdown torque : 300 %  
 Rated speed : 1475 rpm

Moment of inertia (J) : 2.62 sq.ft.lb  
 Duty cycle : Cont.(S1)  
 Insulation class : F  
 Service factor : 1.25  
 Temperature rise : 80 K  
 Design : B

Rev.	Changes Summary	Performed	Checked	Date
Performed by			Page 10 / 36	Revision
Checked by				
Date	13/04/2022			

# LOAD PERFORMANCE CURVE

## Three Phase Induction Motor - Squirrel Cage



Customer :

Product line : NEMA Premium Efficiency Three-Phase

Product code : 12385114

Catalog # : 01518ST3QIE254TC-W22

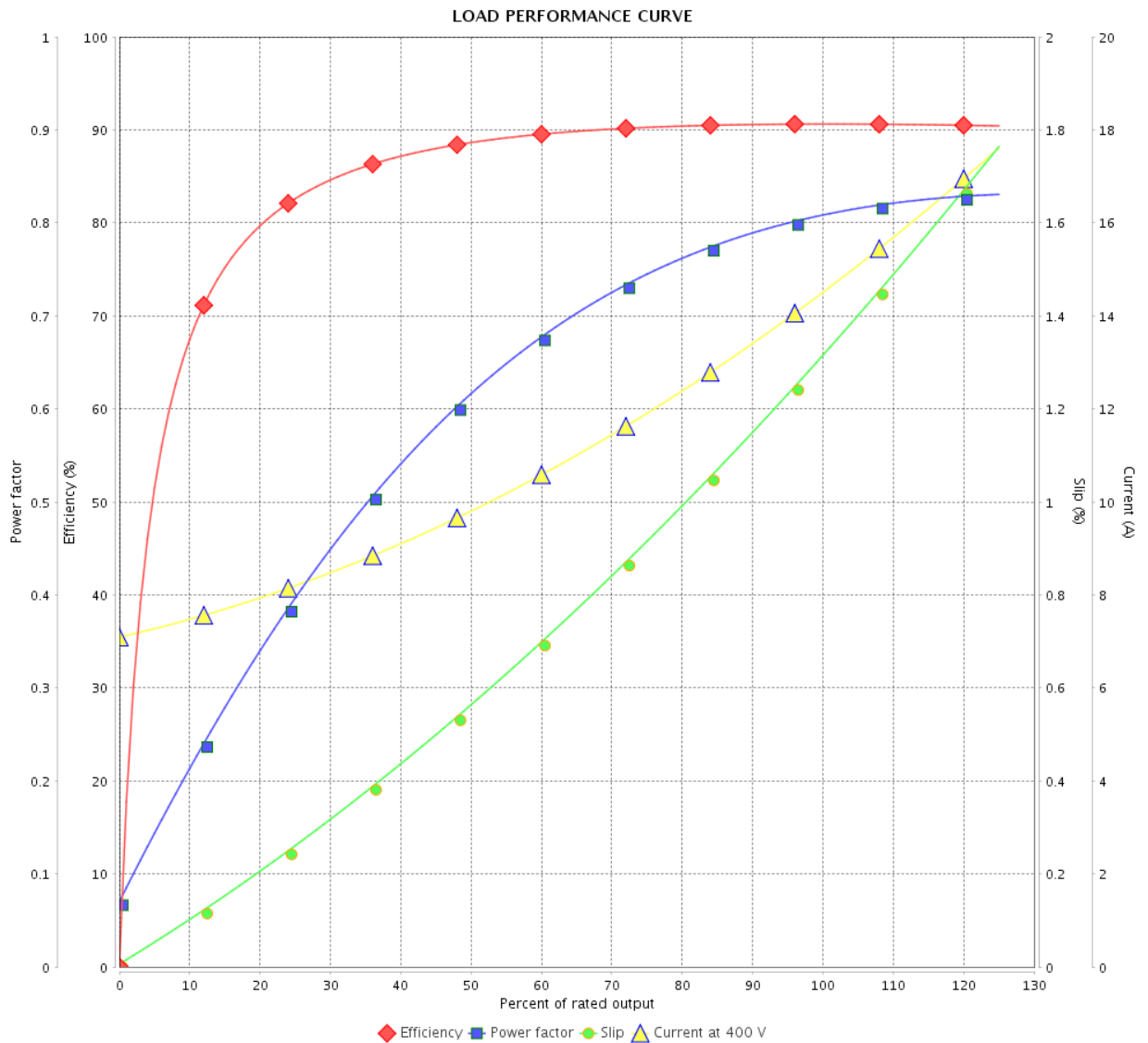

Performance : 400 V 50 Hz 4P IE3

Rated current : 14.8 A  
 LRC : 7.8  
 Rated torque : 35.5 ft.lb  
 Locked rotor torque : 280 %  
 Breakdown torque : 340 %  
 Rated speed : 1480 rpm

Moment of inertia (J) : 2.62 sq.ft.lb  
 Duty cycle : Cont.(S1)  
 Insulation class : F  
 Service factor : 1.25  
 Temperature rise : 80 K  
 Design : B

Rev.	Changes Summary	Performed	Checked	Date
Performed by			Page	Revision
Checked by			11 / 36	
Date	13/04/2022			

# LOAD PERFORMANCE CURVE

Three Phase Induction Motor - Squirrel Cage



Customer :

Product line : NEMA Premium Efficiency Three-Phase

Product code : 12385114

Catalog # : 01518ST3QIE254TC-W22

LOAD PERFORMANCE CURVE

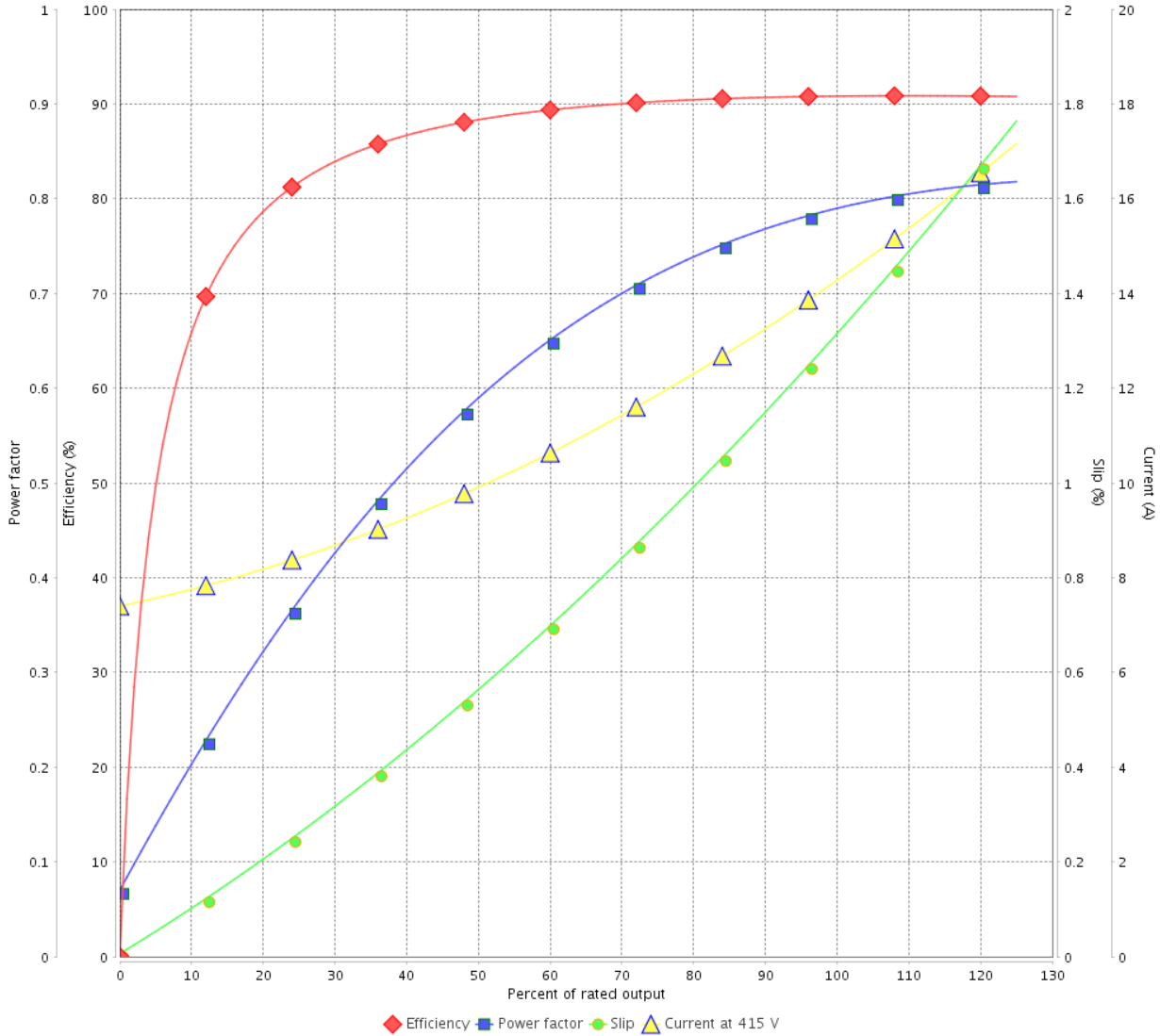

Performance : 415 V 50 Hz 4P IE3

Rated current : 14.5 A  
 LRC : 8.3  
 Rated torque : 35.5 ft.lb  
 Locked rotor torque : 310 %  
 Breakdown torque : 370 %  
 Rated speed : 1480 rpm

Moment of inertia (J) : 2.62 sq.ft.lb  
 Duty cycle : Cont.(S1)  
 Insulation class : F  
 Service factor : 1.25  
 Temperature rise : 80 K  
 Design : B

Rev.	Changes Summary	Performed	Checked	Date
Performed by			Page 12 / 36	Revision
Checked by				
Date	13/04/2022			

# LOAD PERFORMANCE CURVE

## Three Phase Induction Motor - Squirrel Cage



Customer : \_\_\_\_\_

Product line : NEMA Premium Efficiency Three-Phase

Product code : 12385114

Catalog # : 01518ST3QIE254TC-W22

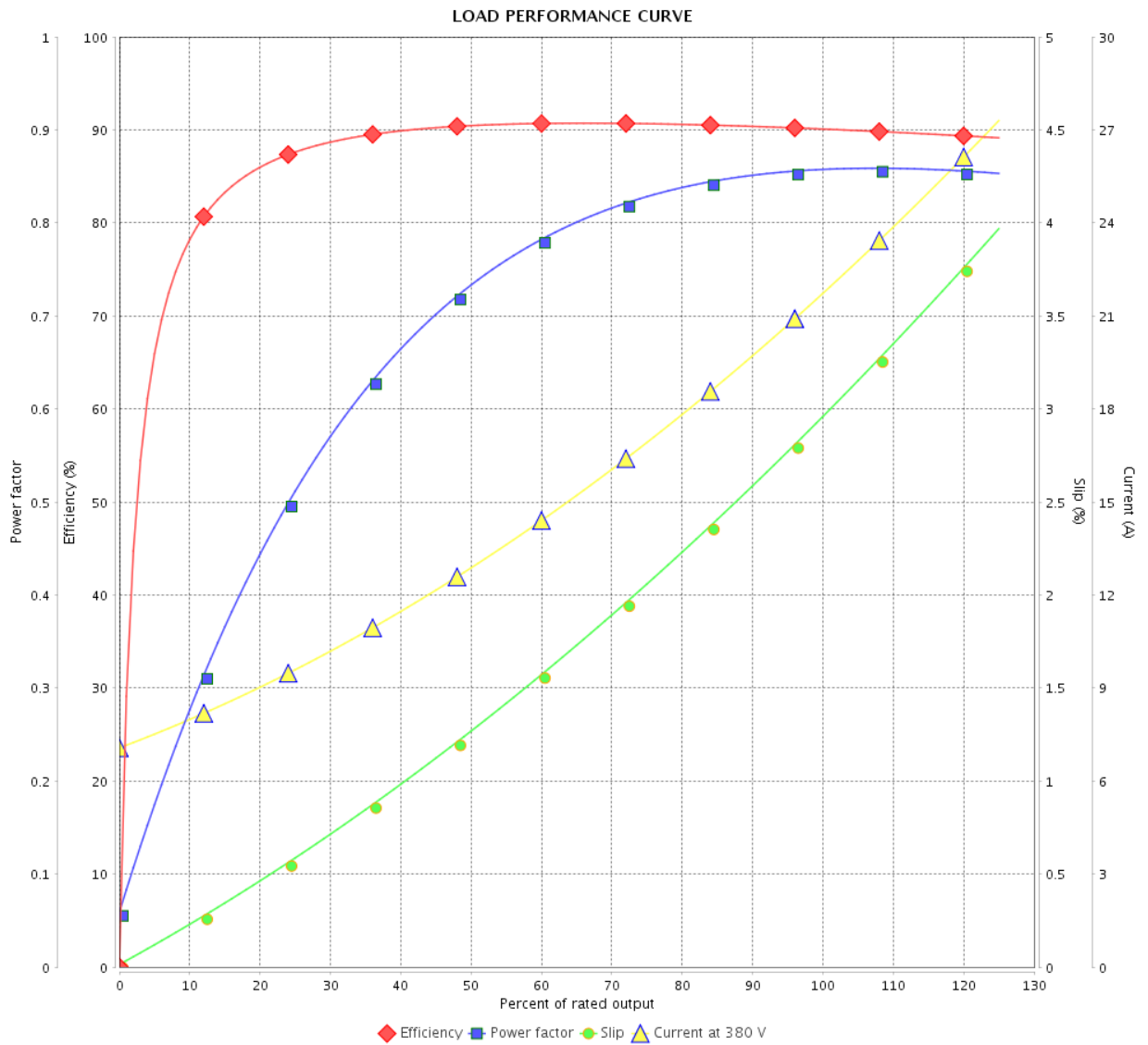

Performance : 380 V 50 Hz 4P IE2

Rated current : 21.5 A  
 LRC : 4.9  
 Rated torque : 54.1 ft.lb  
 Locked rotor torque : 160 %  
 Breakdown torque : 200 %  
 Rated speed : 1455 rpm

Moment of inertia (J) : 2.62 sq.ft.lb  
 Duty cycle : Cont.(S1)  
 Insulation class : F  
 Service factor : 1.00  
 Temperature rise : 80 K  
 Design : B

Rev.	Changes Summary	Performed	Checked	Date
Performed by		Page		Revision
Checked by		13 / 36		
Date		13/04/2022		

# LOAD PERFORMANCE CURVE

Three Phase Induction Motor - Squirrel Cage



Customer :

Product line : NEMA Premium Efficiency Three-Phase

Product code : 12385114

Catalog # : 01518ST3QIE254TC-W22

LOAD PERFORMANCE CURVE

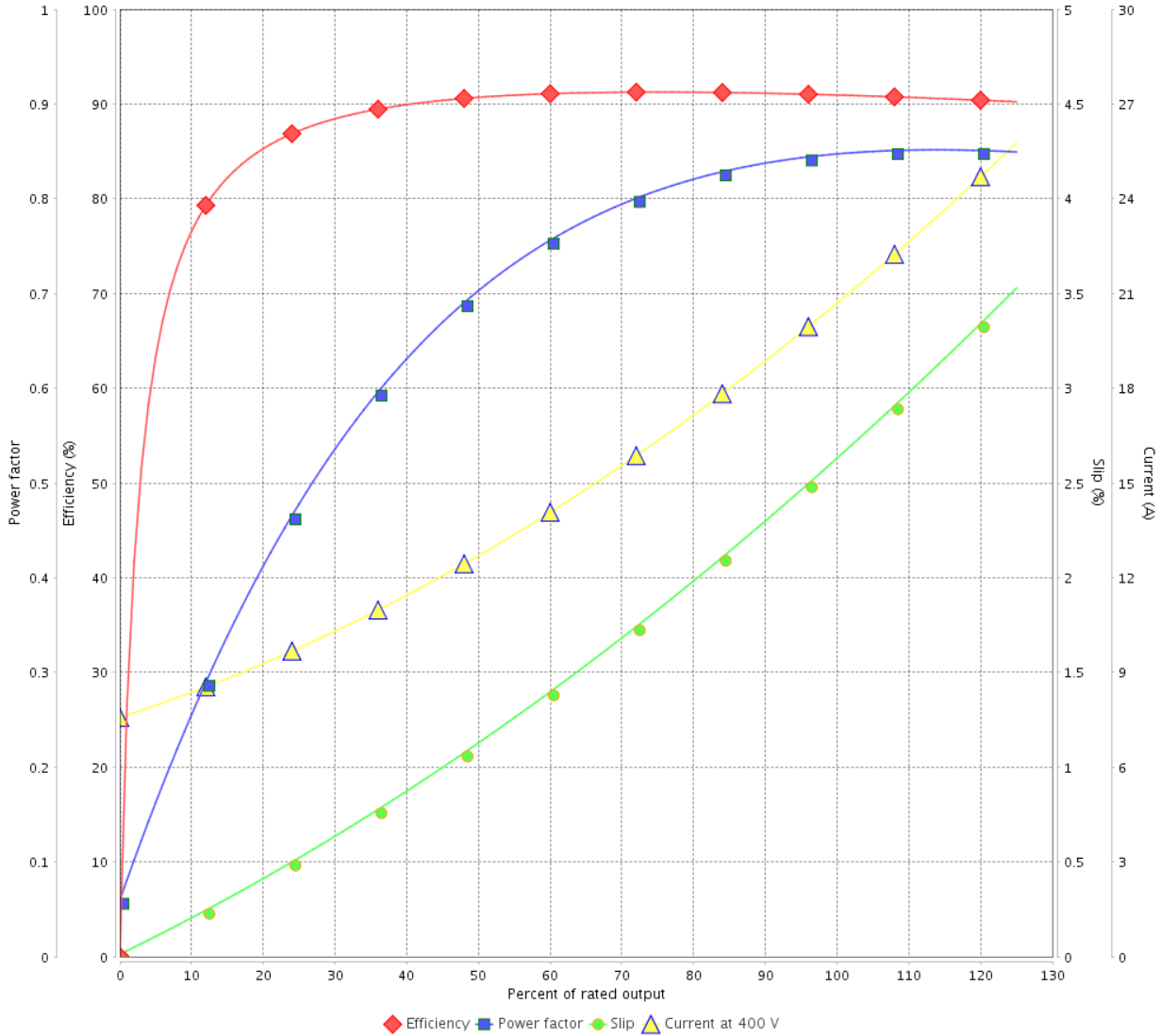

Performance : 400 V 50 Hz 4P IE2

Rated current : 20.5 A  
 LRC : 5.4  
 Rated torque : 54.0 ft.lb  
 Locked rotor torque : 200 %  
 Breakdown torque : 220 %  
 Rated speed : 1460 rpm

Moment of inertia (J) : 2.62 sq.ft.lb  
 Duty cycle : Cont.(S1)  
 Insulation class : F  
 Service factor : 1.00  
 Temperature rise : 80 K  
 Design : B

Rev.	Changes Summary	Performed	Checked	Date
Performed by			Page	Revision
Checked by			14 / 36	
Date	13/04/2022			

# LOAD PERFORMANCE CURVE

## Three Phase Induction Motor - Squirrel Cage



Customer : \_\_\_\_\_

Product line : NEMA Premium Efficiency Three-Phase

Product code : 12385114

Catalog # : 01518ST3QIE254TC-W22

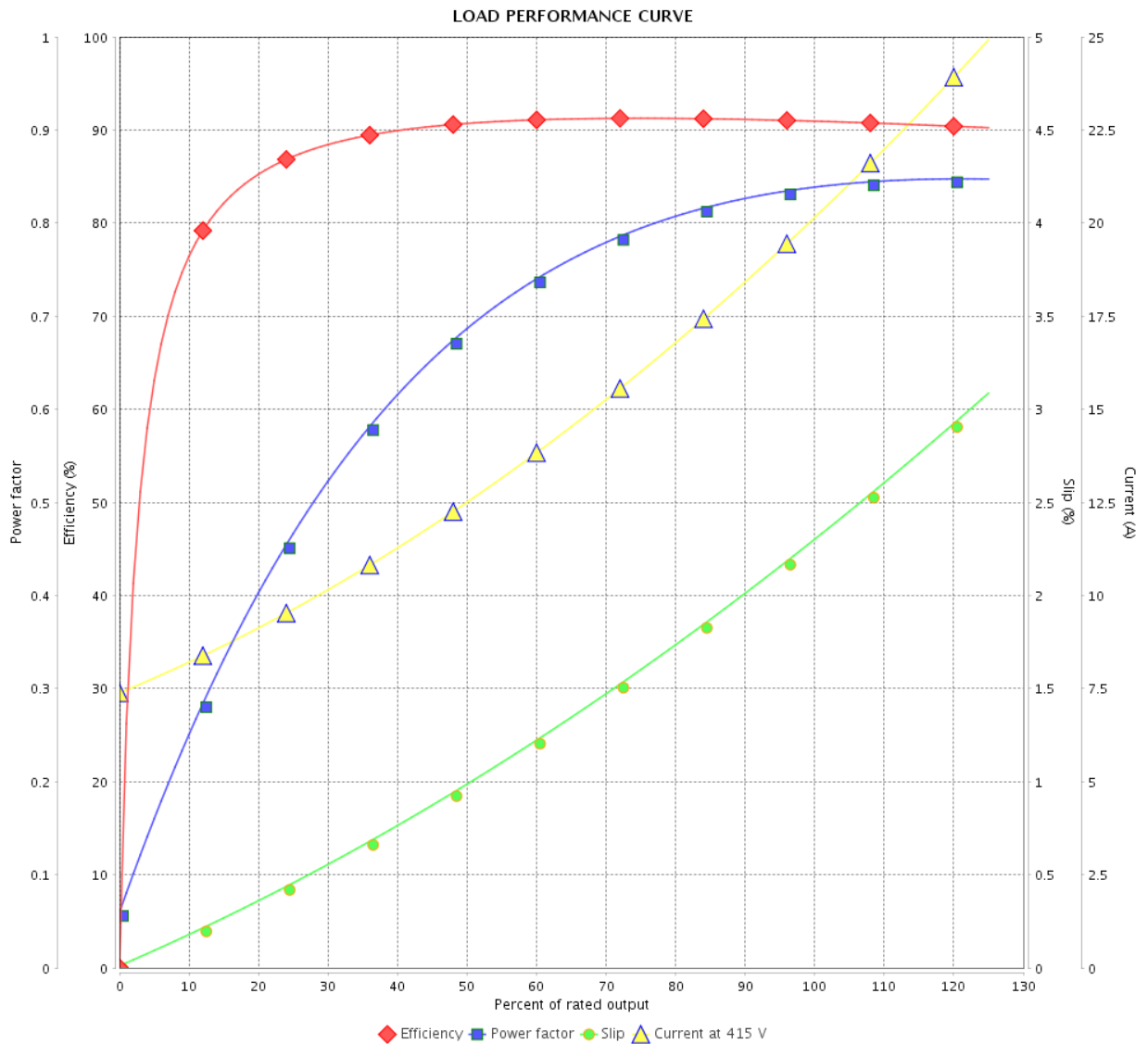

Performance : 415 V 50 Hz 4P IE2

Rated current : 20.0 A  
 LRC : 5.9  
 Rated torque : 53.8 ft.lb  
 Locked rotor torque : 210 %  
 Breakdown torque : 240 %  
 Rated speed : 1465 rpm

Moment of inertia (J) : 2.62 sq.ft.lb  
 Duty cycle : Cont.(S1)  
 Insulation class : F  
 Service factor : 1.00  
 Temperature rise : 80 K  
 Design : B

Rev.	Changes Summary	Performed	Checked	Date
Performed by		Page		Revision
Checked by		15 / 36		
Date		13/04/2022		

# THERMAL LIMIT CURVE



## Three Phase Induction Motor - Squirrel Cage

Customer :

Product line : NEMA Premium Efficiency Three-Phase  
Product code : 12385114  
Catalog # : 01518ST3QIE254TC-W22

Performance : 460 V 60 Hz 4P

Rated current	: 18.0 A	Moment of inertia (J)	: 2.62 sq.ft.lb
LRC	: 6.4	Duty cycle	: Cont.(S1)
Rated torque	: 44.6 ft.lb	Insulation class	: F
Locked rotor torque	: 240 %	Service factor	: 1.25
Breakdown torque	: 260 %	Temperature rise	: 80 K
Rated speed	: 1768 rpm	Design	: B

Heating constant

Cooling constant

Rev.	Changes Summary	Performed	Checked	Date
Performed by				
Checked by			Page	Revision
Date	13/04/2022		16 / 36	



# THERMAL LIMIT CURVE

Three Phase Induction Motor - Squirrel Cage



Customer : \_\_\_\_\_

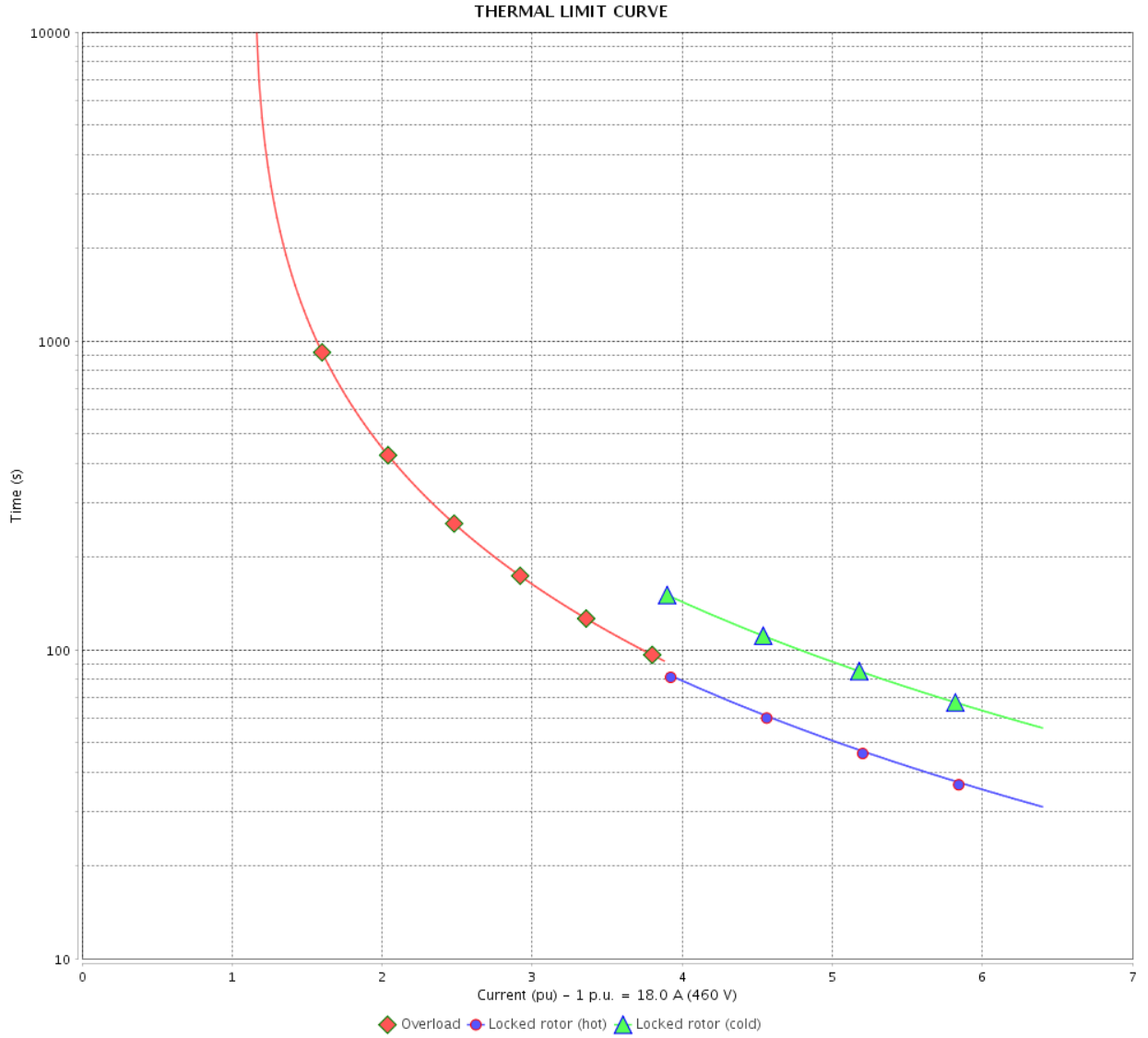

Rev.	Changes Summary	Performed	Checked	Date
Performed by		Page		Revision
Checked by		17 / 36		
Date		13/04/2022		

# THERMAL LIMIT CURVE

## Three Phase Induction Motor - Squirrel Cage



Customer :

Product line : NEMA Premium Efficiency Three-Phase

Product code : 12385114

Catalog # : 01518ST3QIE254TC-W22

Performance : 380 V 50 Hz 4P IE3

Rated current	: 15.2 A	Moment of inertia (J)	: 2.62 sq.ft.lb
LRC	: 7.2	Duty cycle	: Cont.(S1)
Rated torque	: 35.6 ft.lb	Insulation class	: F
Locked rotor torque	: 250 %	Service factor	: 1.25
Breakdown torque	: 300 %	Temperature rise	: 80 K
Rated speed	: 1475 rpm	Design	: B

Heating constant

Cooling constant

Rev.	Changes Summary	Performed	Checked	Date
Performed by				
Checked by			Page	Revision
Date	13/04/2022		18 / 36	

# THERMAL LIMIT CURVE

Three Phase Induction Motor - Squirrel Cage



Customer : \_\_\_\_\_

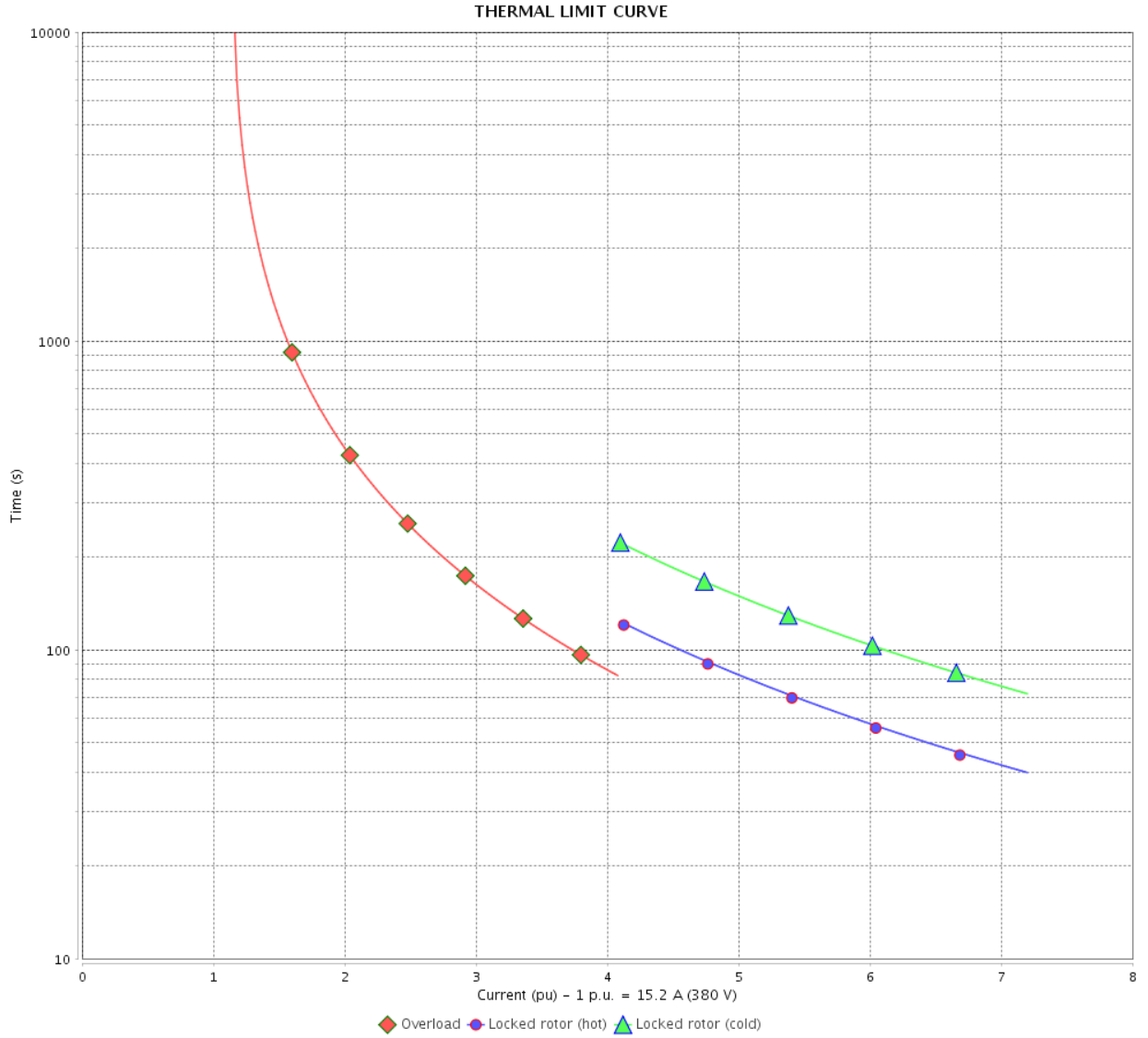

Rev.	Changes Summary	Performed	Checked	Date
Performed by		Page 19 / 36		Revision
Checked by				
Date				

# THERMAL LIMIT CURVE

## Three Phase Induction Motor - Squirrel Cage



Customer :

Product line : NEMA Premium Efficiency Three-Phase  
Product code : 12385114  
Catalog # : 01518ST3QIE254TC-W22

Performance : 400 V 50 Hz 4P IE3

Rated current	: 14.8 A	Moment of inertia (J)	: 2.62 sq.ft.lb
LRC	: 7.8	Duty cycle	: Cont.(S1)
Rated torque	: 35.5 ft.lb	Insulation class	: F
Locked rotor torque	: 280 %	Service factor	: 1.25
Breakdown torque	: 340 %	Temperature rise	: 80 K
Rated speed	: 1480 rpm	Design	: B

Heating constant

Cooling constant

Rev.	Changes Summary	Performed	Checked	Date
Performed by				
Checked by			Page	Revision
Date	13/04/2022		20 / 36	

# THERMAL LIMIT CURVE

Three Phase Induction Motor - Squirrel Cage



Customer : \_\_\_\_\_

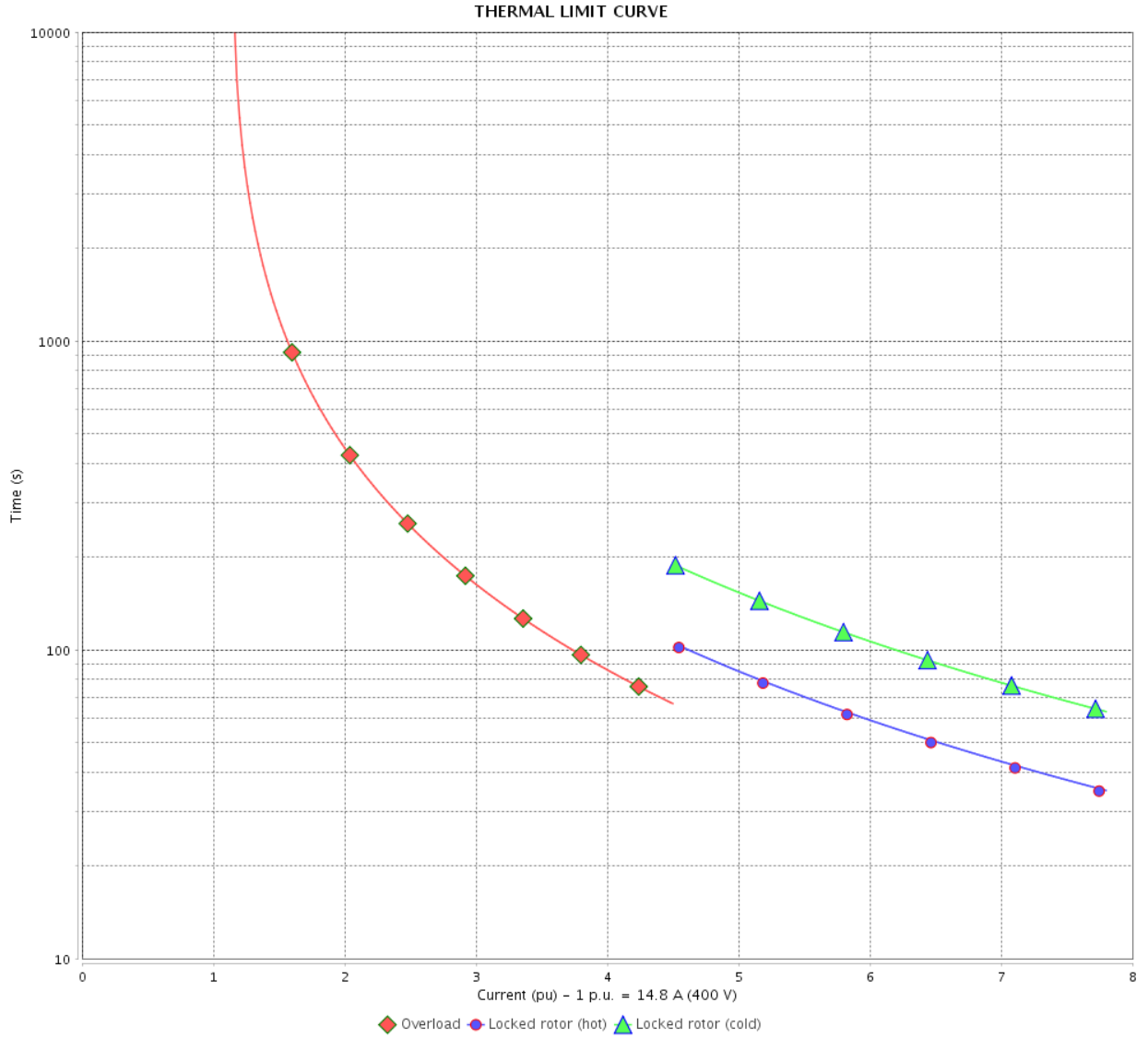

Rev.	Changes Summary	Performed	Checked	Date
Performed by		Page 21 / 36		Revision
Checked by				
Date				

# THERMAL LIMIT CURVE



## Three Phase Induction Motor - Squirrel Cage

Customer :

Product line : NEMA Premium Efficiency Three-Phase  
Product code : 12385114  
Catalog # : 01518ST3QIE254TC-W22

Performance : 415 V 50 Hz 4P IE3

Rated current	: 14.5 A	Moment of inertia (J)	: 2.62 sq.ft.lb
LRC	: 8.3	Duty cycle	: Cont.(S1)
Rated torque	: 35.5 ft.lb	Insulation class	: F
Locked rotor torque	: 310 %	Service factor	: 1.25
Breakdown torque	: 370 %	Temperature rise	: 80 K
Rated speed	: 1480 rpm	Design	: B

Heating constant

Cooling constant

Rev.	Changes Summary	Performed	Checked	Date
Performed by				
Checked by			Page	Revision
Date	13/04/2022		22 / 36	

# THERMAL LIMIT CURVE

Three Phase Induction Motor - Squirrel Cage



Customer : \_\_\_\_\_

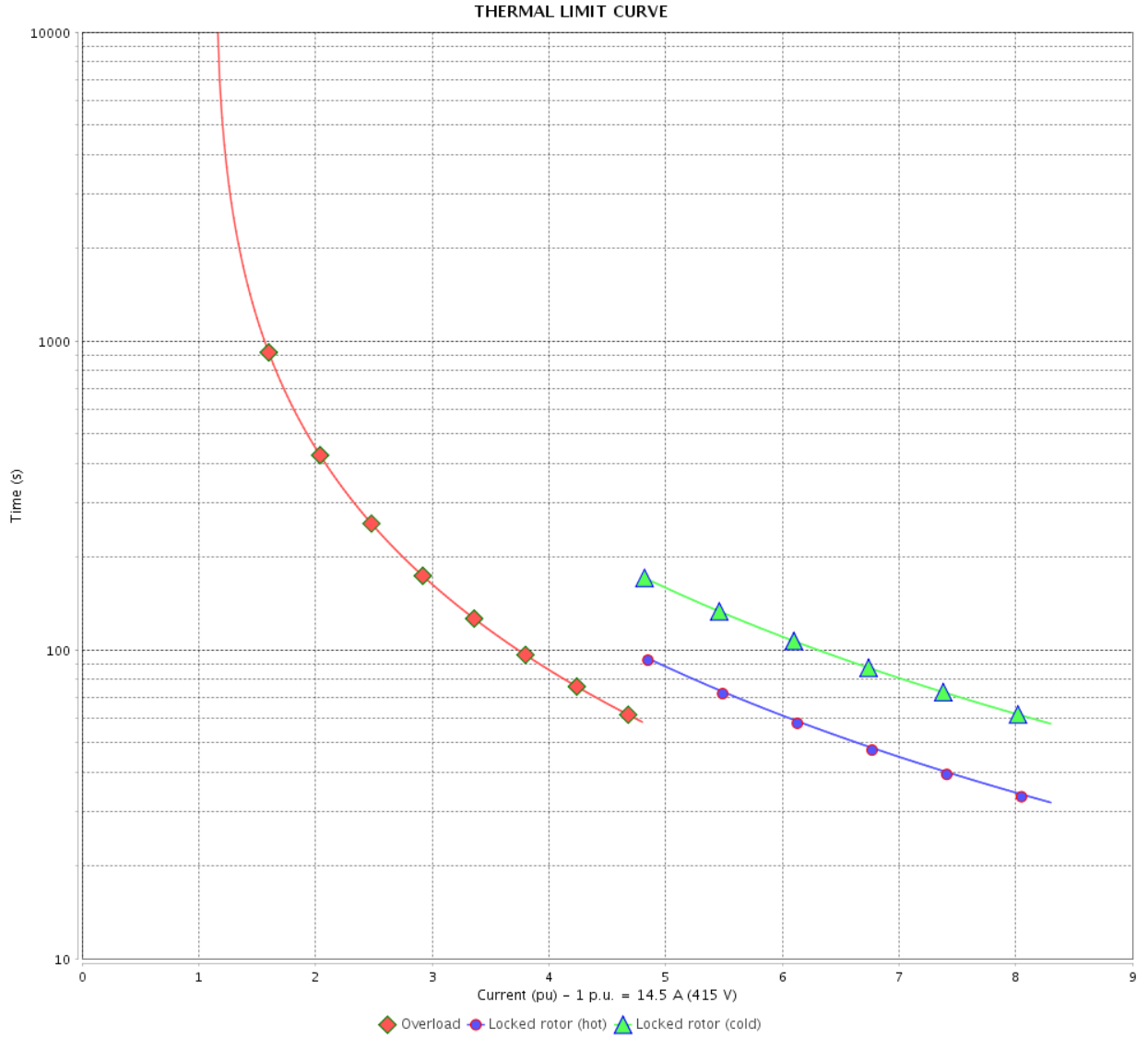

Rev.	Changes Summary	Performed	Checked	Date
Performed by		Page		Revision
Checked by		23 / 36		
Date		13/04/2022		

# THERMAL LIMIT CURVE



## Three Phase Induction Motor - Squirrel Cage

Customer :

Product line : NEMA Premium Efficiency Three-Phase  
Product code : 12385114  
Catalog # : 01518ST3QIE254TC-W22

Performance : 380 V 50 Hz 4P IE2

Rated current	: 21.5 A	Moment of inertia (J)	: 2.62 sq.ft.lb
LRC	: 4.9	Duty cycle	: Cont.(S1)
Rated torque	: 54.1 ft.lb	Insulation class	: F
Locked rotor torque	: 160 %	Service factor	: 1.00
Breakdown torque	: 200 %	Temperature rise	: 80 K
Rated speed	: 1455 rpm	Design	: B

Heating constant

Cooling constant

Rev.	Changes Summary	Performed	Checked	Date
Performed by				
Checked by			Page	Revision
Date	13/04/2022		24 / 36	



# THERMAL LIMIT CURVE

Three Phase Induction Motor - Squirrel Cage



Customer : \_\_\_\_\_

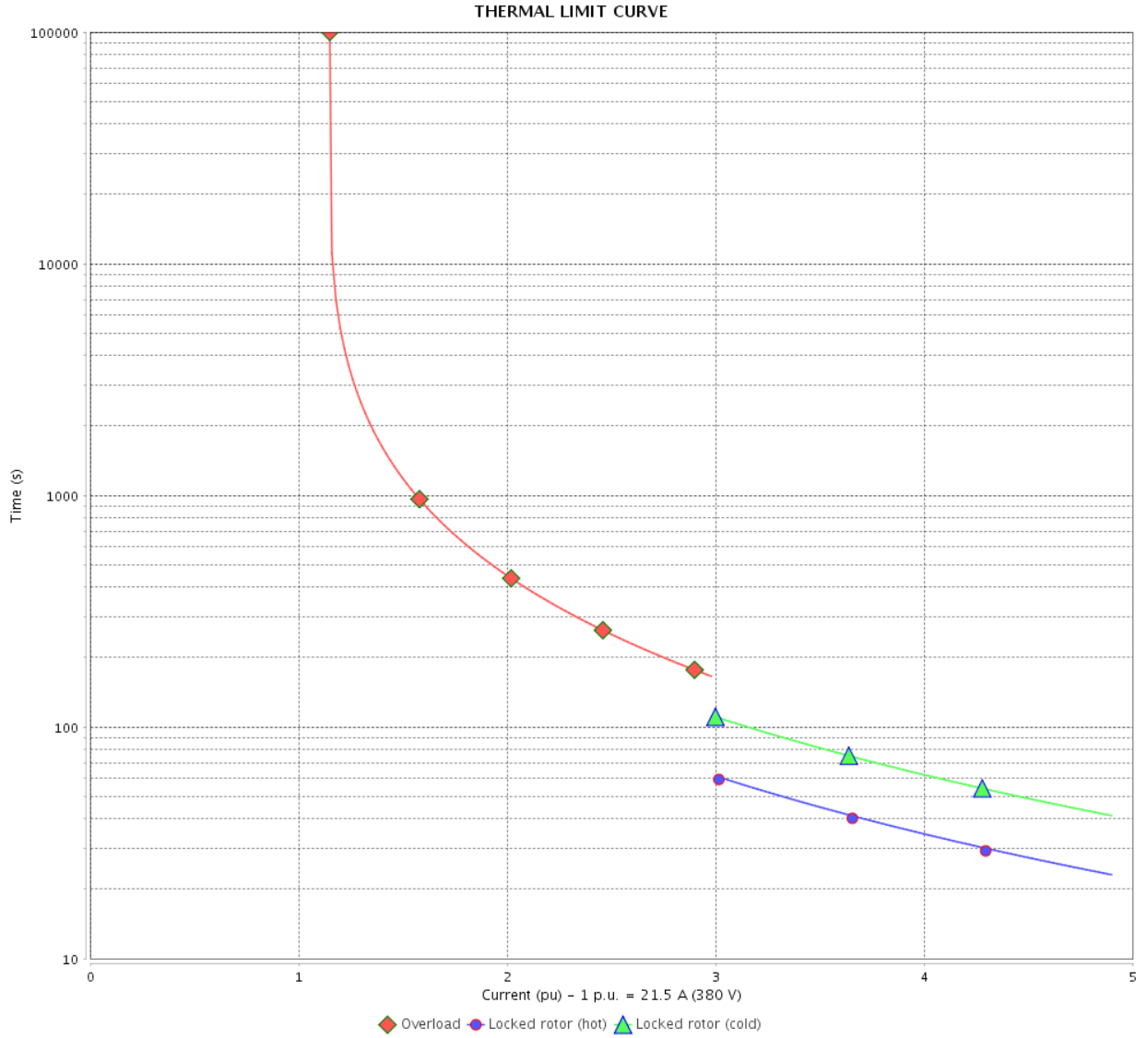

Rev.	Changes Summary	Performed	Checked	Date
Performed by		Page 25 / 36		Revision
Checked by				
Date				

# THERMAL LIMIT CURVE

## Three Phase Induction Motor - Squirrel Cage



Customer :

Product line : NEMA Premium Efficiency Three-Phase  
Product code : 12385114  
Catalog # : 01518ST3QIE254TC-W22

Performance : 400 V 50 Hz 4P IE2

Rated current	: 20.5 A	Moment of inertia (J)	: 2.62 sq.ft.lb
LRC	: 5.4	Duty cycle	: Cont.(S1)
Rated torque	: 54.0 ft.lb	Insulation class	: F
Locked rotor torque	: 200 %	Service factor	: 1.00
Breakdown torque	: 220 %	Temperature rise	: 80 K
Rated speed	: 1460 rpm	Design	: B

Heating constant

Cooling constant

Rev.	Changes Summary	Performed	Checked	Date
Performed by				
Checked by				
Date	13/04/2022		Page 26 / 36	Revision

# THERMAL LIMIT CURVE

Three Phase Induction Motor - Squirrel Cage



Customer : \_\_\_\_\_

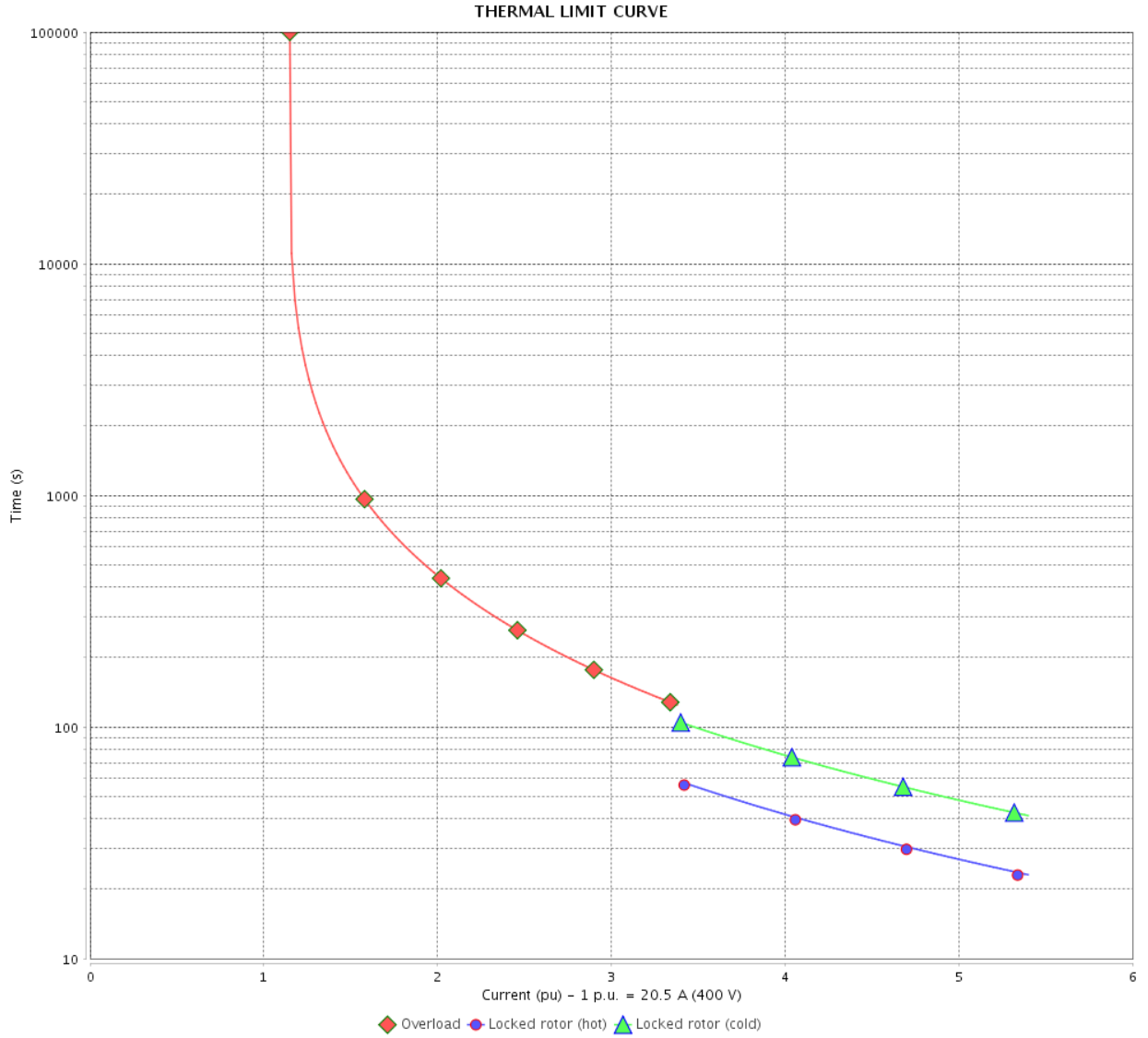

Rev.	Changes Summary	Performed	Checked	Date
Performed by				
Checked by				
Date				
			Page	Revision
			27 / 36	

# THERMAL LIMIT CURVE



## Three Phase Induction Motor - Squirrel Cage

Customer :

Product line : NEMA Premium Efficiency Three-Phase  
Product code : 12385114  
Catalog # : 01518ST3QIE254TC-W22

Performance : 415 V 50 Hz 4P IE2

Rated current	: 20.0 A	Moment of inertia (J)	: 2.62 sq.ft.lb
LRC	: 5.9	Duty cycle	: Cont.(S1)
Rated torque	: 53.8 ft.lb	Insulation class	: F
Locked rotor torque	: 210 %	Service factor	: 1.00
Breakdown torque	: 240 %	Temperature rise	: 80 K
Rated speed	: 1465 rpm	Design	: B

Heating constant

Cooling constant

Rev.	Changes Summary	Performed	Checked	Date
Performed by				
Checked by			Page	Revision
Date	13/04/2022		28 / 36	

# THERMAL LIMIT CURVE

Three Phase Induction Motor - Squirrel Cage



Customer : \_\_\_\_\_

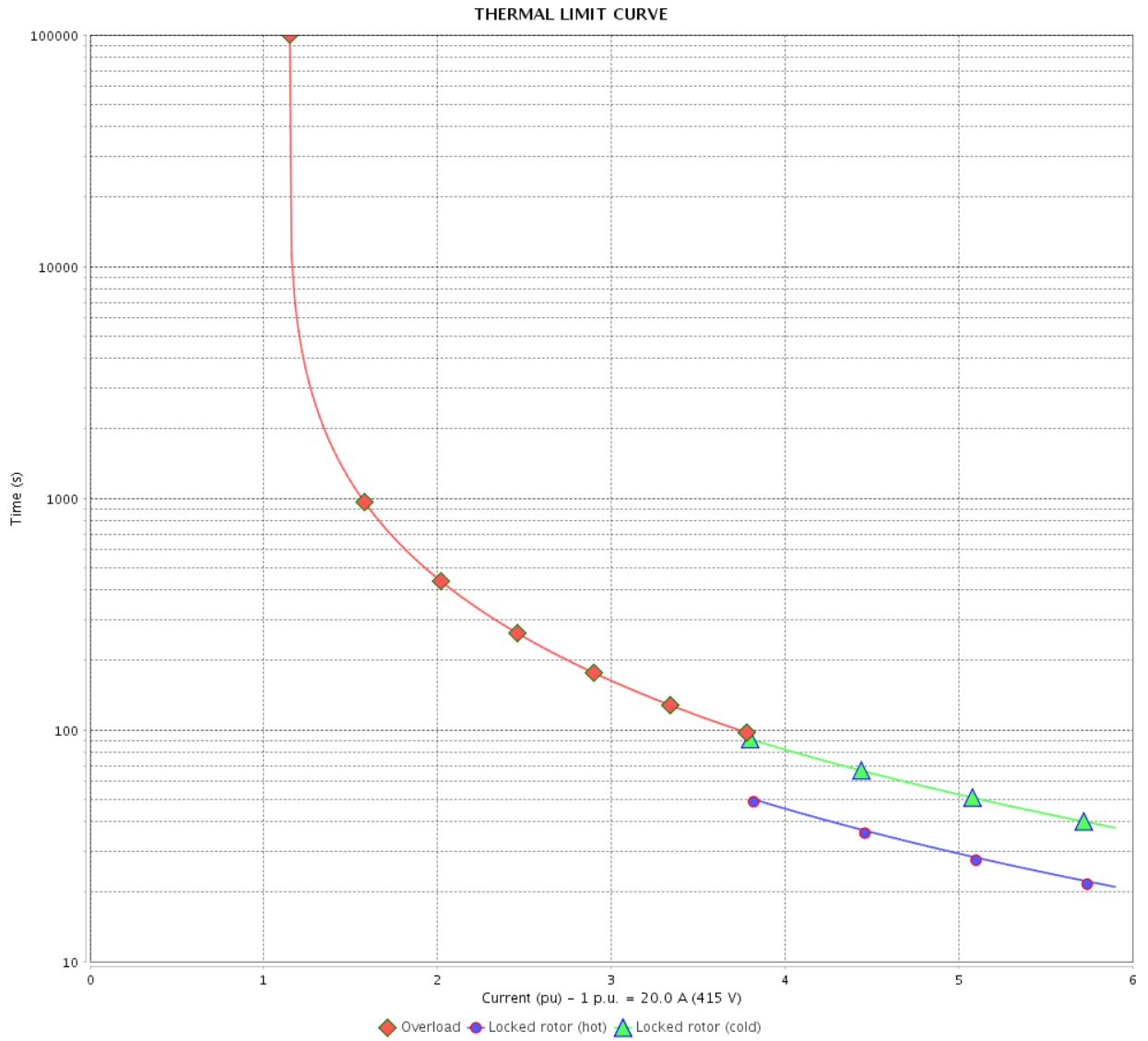

Rev.	Changes Summary	Performed	Checked	Date
Performed by		Page 29 / 36		Revision
Checked by				
Date				

# VFD OPERATION CURVE

Three Phase Induction Motor - Squirrel Cage



Customer :

Product line : NEMA Premium Efficiency Three-Phase

Product code : 12385114

Catalog # : 01518ST3QIE254TC-W22

VFD OPERATION CURVE

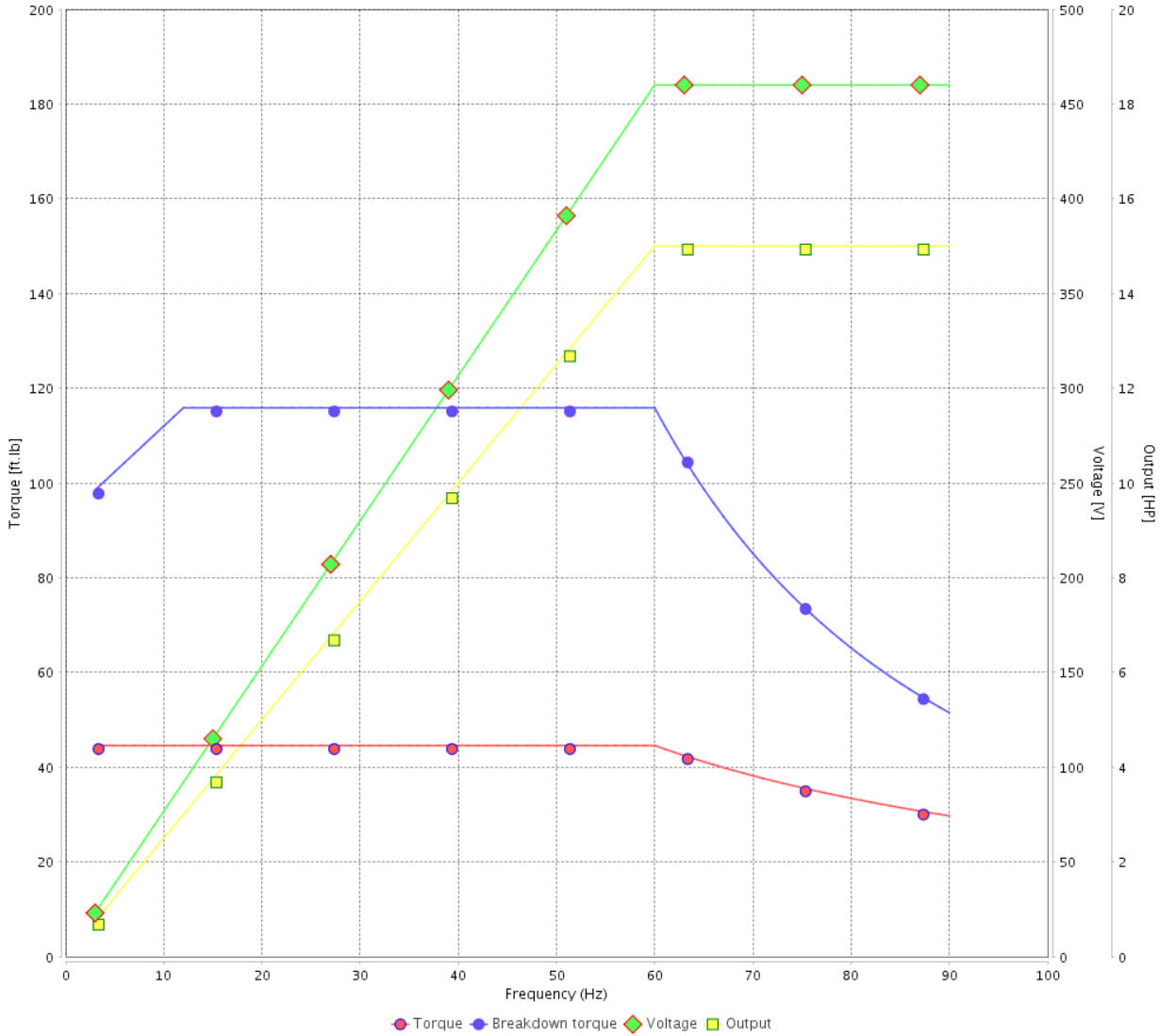

Performance : 460 V 60 Hz 4P

Rated current : 18.0 A  
 LRC : 6.4  
 Rated torque : 44.6 ft.lb  
 Locked rotor torque : 240 %  
 Breakdown torque : 260 %  
 Rated speed : 1768 rpm

Moment of inertia (J) : 2.62 sq.ft.lb  
 Duty cycle : Cont.(S1)  
 Insulation class : F  
 Service factor : 1.25  
 Temperature rise : 80 K  
 Design : B

Rev.	Changes Summary	Performed	Checked	Date
Performed by			Page 30 / 36	Revision
Checked by				
Date	13/04/2022			

# VFD OPERATION CURVE

Three Phase Induction Motor - Squirrel Cage



Customer :

Product line : NEMA Premium Efficiency Three-Phase

Product code : 12385114

Catalog # : 01518ST3QIE254TC-W22

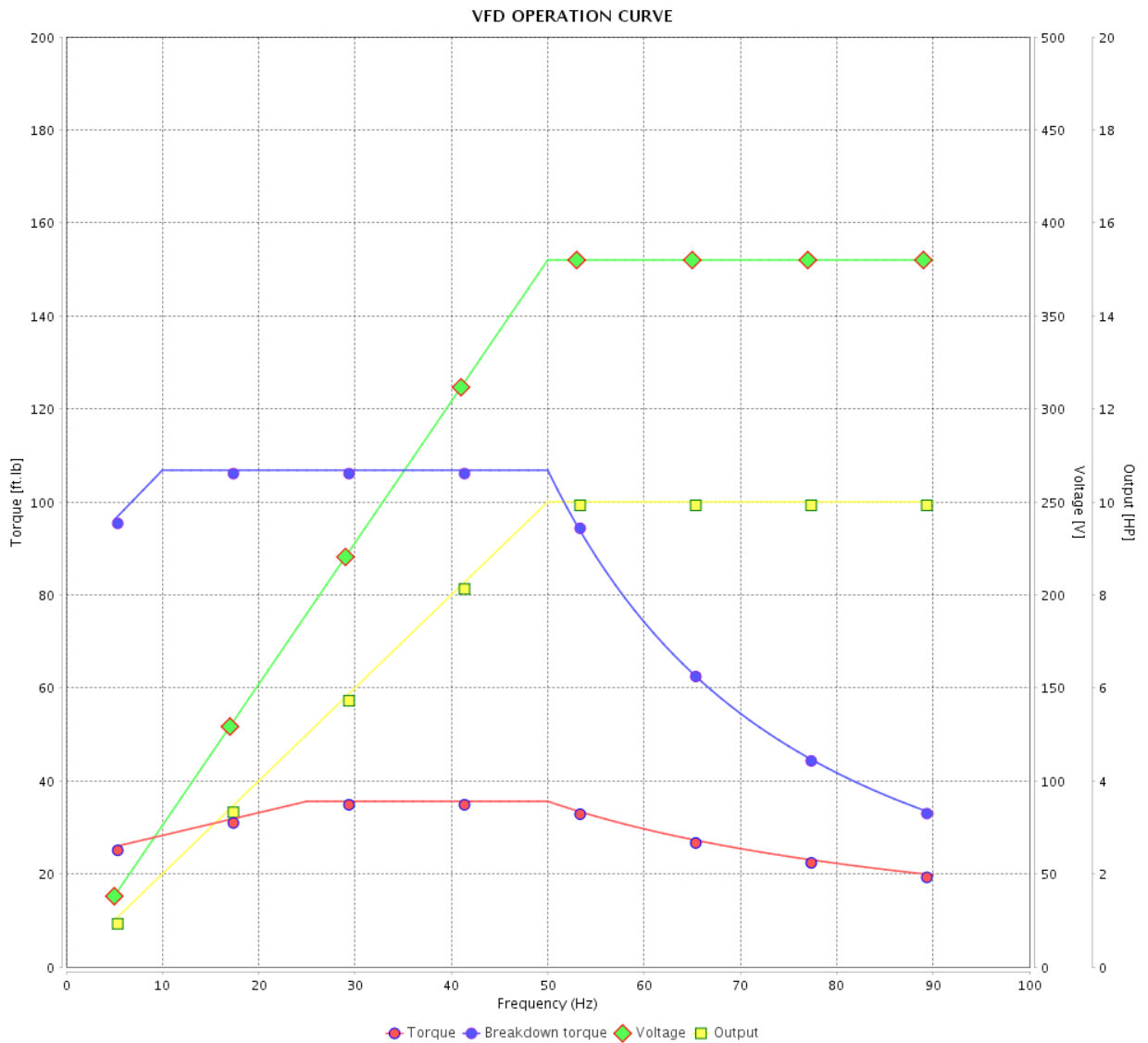

Performance : 380 V 50 Hz 4P IE3

Rated current : 15.2 A  
 LRC : 7.2  
 Rated torque : 35.6 ft.lb  
 Locked rotor torque : 250 %  
 Breakdown torque : 300 %  
 Rated speed : 1475 rpm

Moment of inertia (J) : 2.62 sq.ft.lb  
 Duty cycle : Cont.(S1)  
 Insulation class : F  
 Service factor : 1.25  
 Temperature rise : 80 K  
 Design : B

Rev.	Changes Summary	Performed	Checked	Date
Performed by			Page 31 / 36	Revision
Checked by				
Date	13/04/2022			

# VFD OPERATION CURVE

Three Phase Induction Motor - Squirrel Cage



Customer :

Product line : NEMA Premium Efficiency Three-Phase

Product code : 12385114

Catalog # : 01518ST3QIE254TC-W22

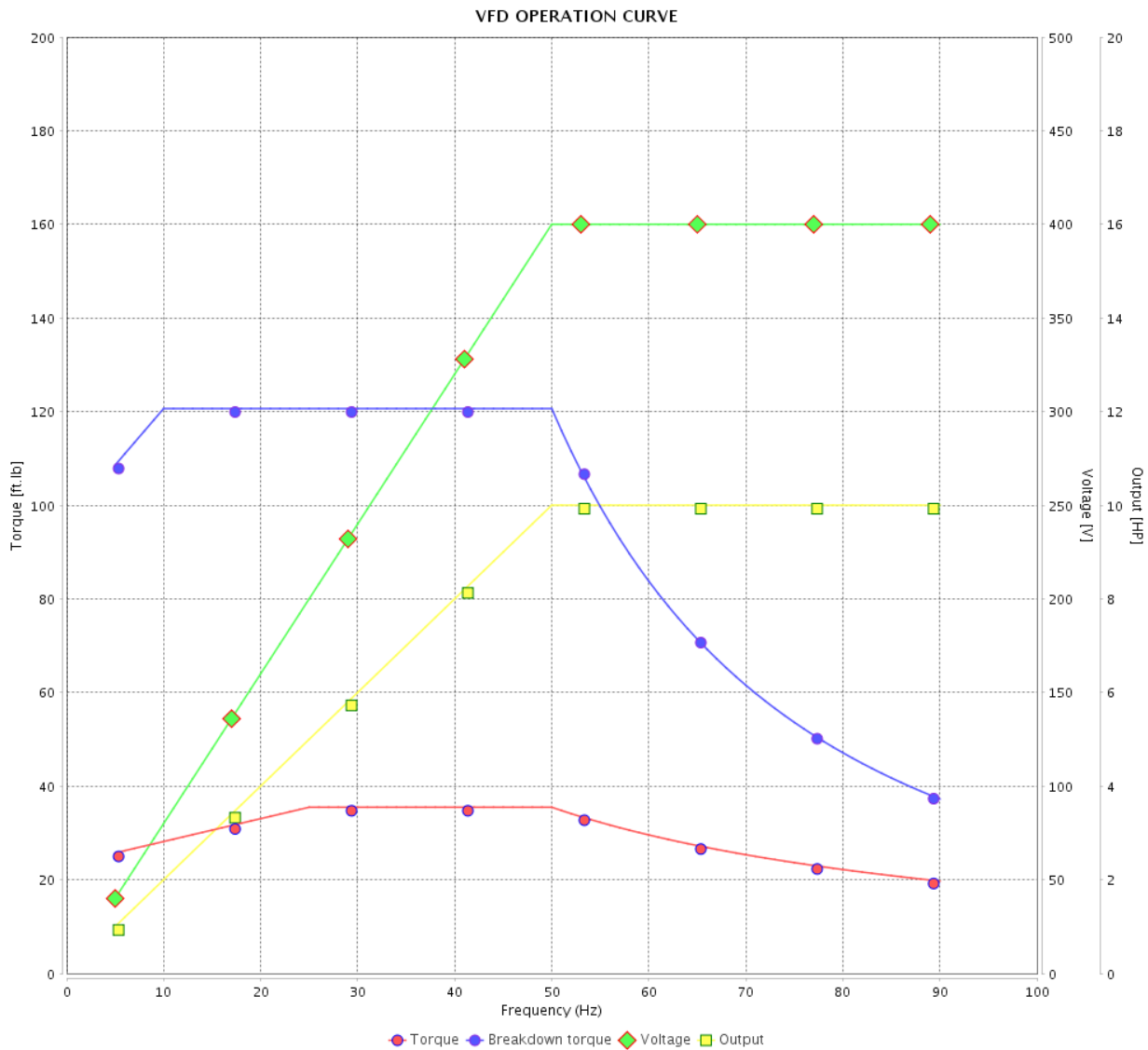

Performance : 400 V 50 Hz 4P IE3

Rated current	: 14.8 A	Moment of inertia (J)	: 2.62 sq.ft.lb
LRC	: 7.8	Duty cycle	: Cont.(S1)
Rated torque	: 35.5 ft.lb	Insulation class	: F
Locked rotor torque	: 280 %	Service factor	: 1.25
Breakdown torque	: 340 %	Temperature rise	: 80 K
Rated speed	: 1480 rpm	Design	: B

Rev.	Changes Summary	Performed	Checked	Date
Performed by			Page 32 / 36	Revision
Checked by				
Date	13/04/2022			



# VFD OPERATION CURVE

Three Phase Induction Motor - Squirrel Cage



Customer :

Product line : NEMA Premium Efficiency Three-Phase

Product code : 12385114

Catalog # : 01518ST3QIE254TC-W22

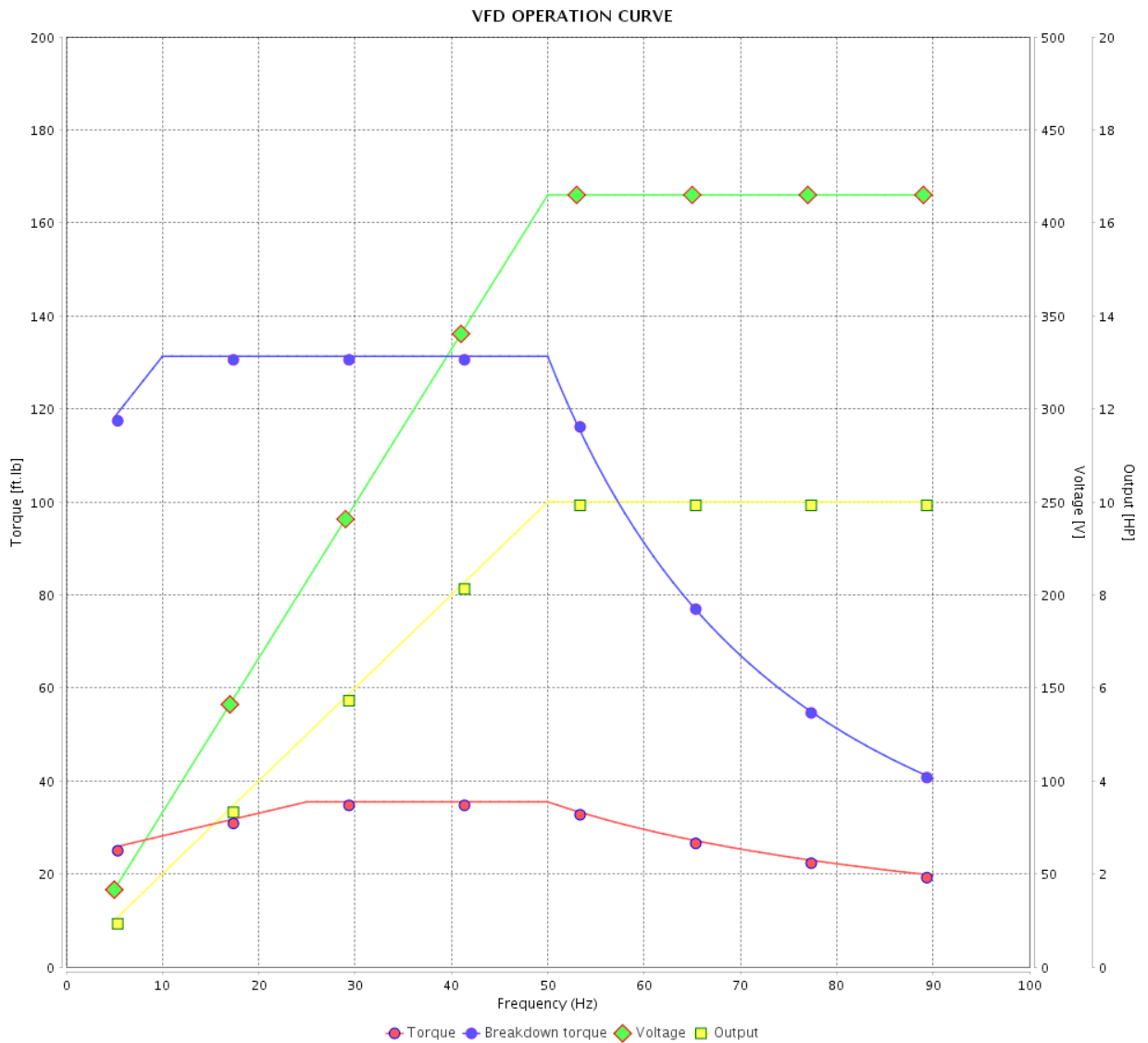

Performance : 415 V 50 Hz 4P IE3

Rated current : 14.5 A  
 LRC : 8.3  
 Rated torque : 35.5 ft.lb  
 Locked rotor torque : 310 %  
 Breakdown torque : 370 %  
 Rated speed : 1480 rpm

Moment of inertia (J) : 2.62 sq.ft.lb  
 Duty cycle : Cont.(S1)  
 Insulation class : F  
 Service factor : 1.25  
 Temperature rise : 80 K  
 Design : B

Rev.	Changes Summary	Performed	Checked	Date
Performed by		Page		Revision
Checked by		33 / 36		
Date		13/04/2022		

# VFD OPERATION CURVE

Three Phase Induction Motor - Squirrel Cage



Customer :

Product line : NEMA Premium Efficiency Three-Phase

Product code : 12385114

Catalog # : 01518ST3QIE254TC-W22

VFD OPERATION CURVE

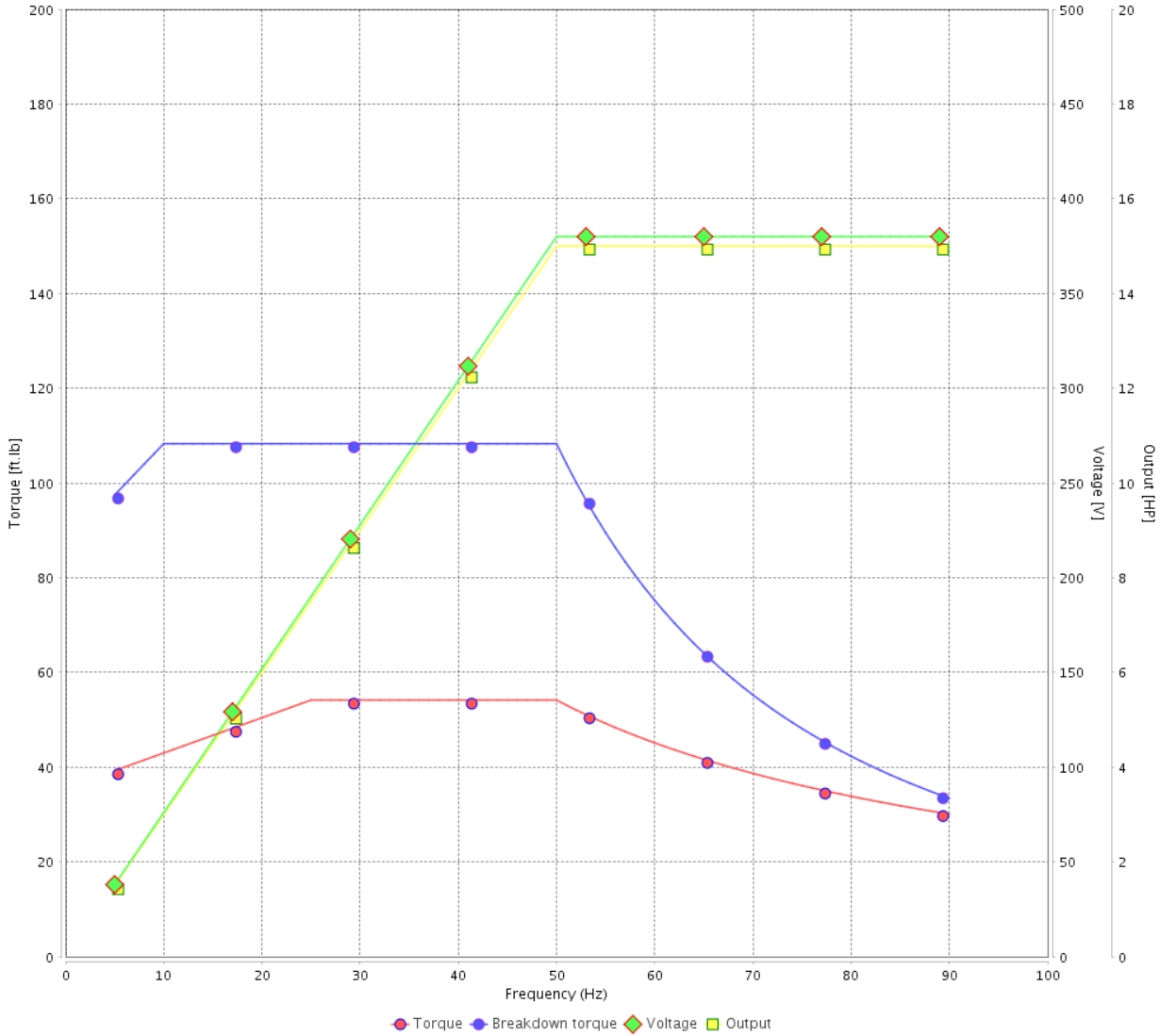

Performance : 380 V 50 Hz 4P IE2

Rated current	: 21.5 A	Moment of inertia (J)	: 2.62 sq.ft.lb
LRC	: 4.9	Duty cycle	: Cont.(S1)
Rated torque	: 54.1 ft.lb	Insulation class	: F
Locked rotor torque	: 160 %	Service factor	: 1.00
Breakdown torque	: 200 %	Temperature rise	: 80 K
Rated speed	: 1455 rpm	Design	: B

Rev.	Changes Summary	Performed	Checked	Date
Performed by			Page 34 / 36	Revision
Checked by				
Date	13/04/2022			

# VFD OPERATION CURVE

Three Phase Induction Motor - Squirrel Cage



Customer :

Product line : NEMA Premium Efficiency Three-Phase

Product code : 12385114

Catalog # : 01518ST3QIE254TC-W22

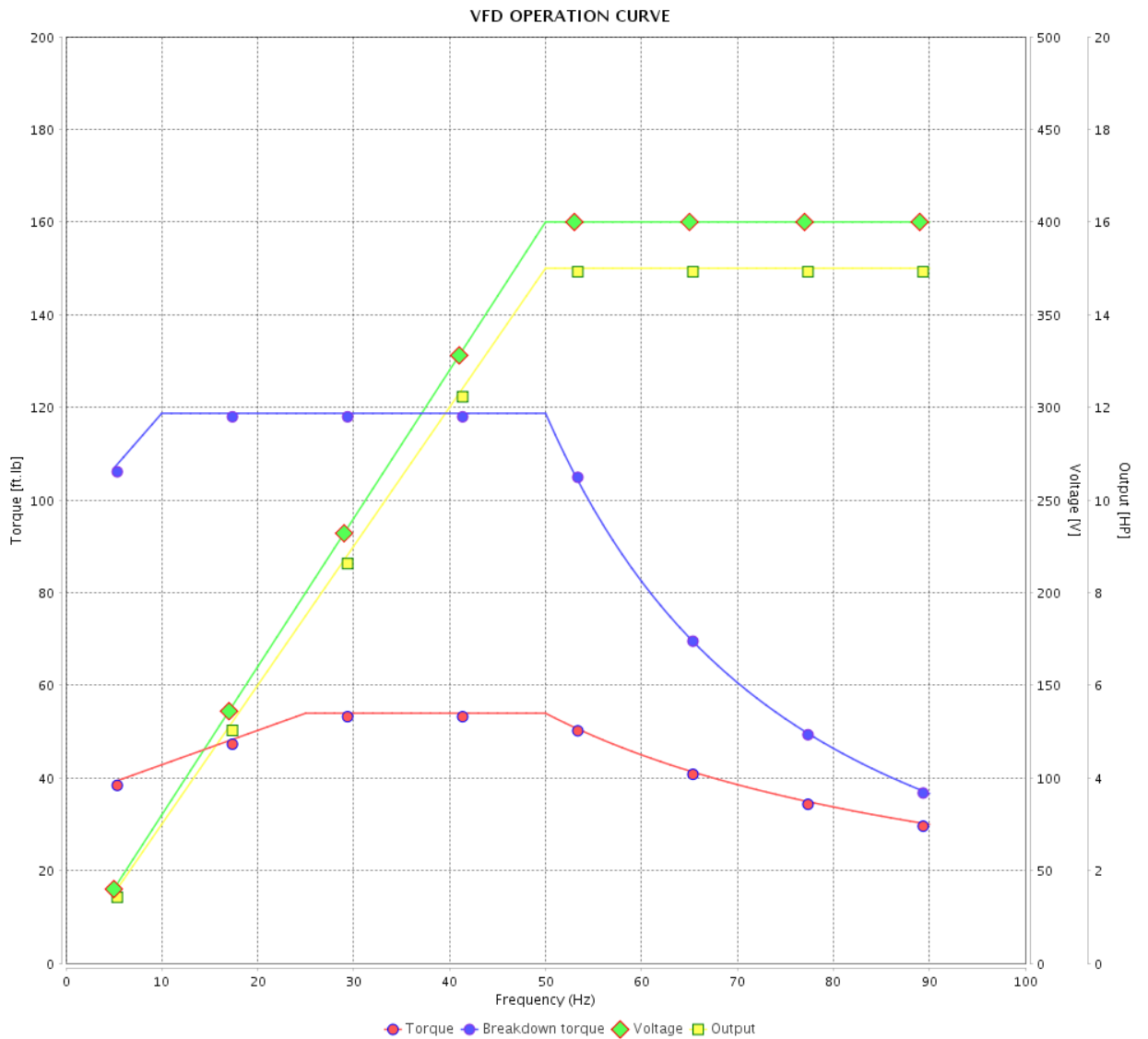

Performance : 400 V 50 Hz 4P IE2

Rated current : 20.5 A  
 LRC : 5.4  
 Rated torque : 54.0 ft.lb  
 Locked rotor torque : 200 %  
 Breakdown torque : 220 %  
 Rated speed : 1460 rpm

Moment of inertia (J) : 2.62 sq.ft.lb  
 Duty cycle : Cont.(S1)  
 Insulation class : F  
 Service factor : 1.00  
 Temperature rise : 80 K  
 Design : B

Rev.	Changes Summary	Performed	Checked	Date
Performed by		Page		Revision
Checked by		35 / 36		
Date		13/04/2022		

# VFD OPERATION CURVE

Three Phase Induction Motor - Squirrel Cage



Customer : \_\_\_\_\_

Product line : NEMA Premium Efficiency Three-Phase

Product code : 12385114

Catalog # : 01518ST3QIE254TC-W22

VFD OPERATION CURVE

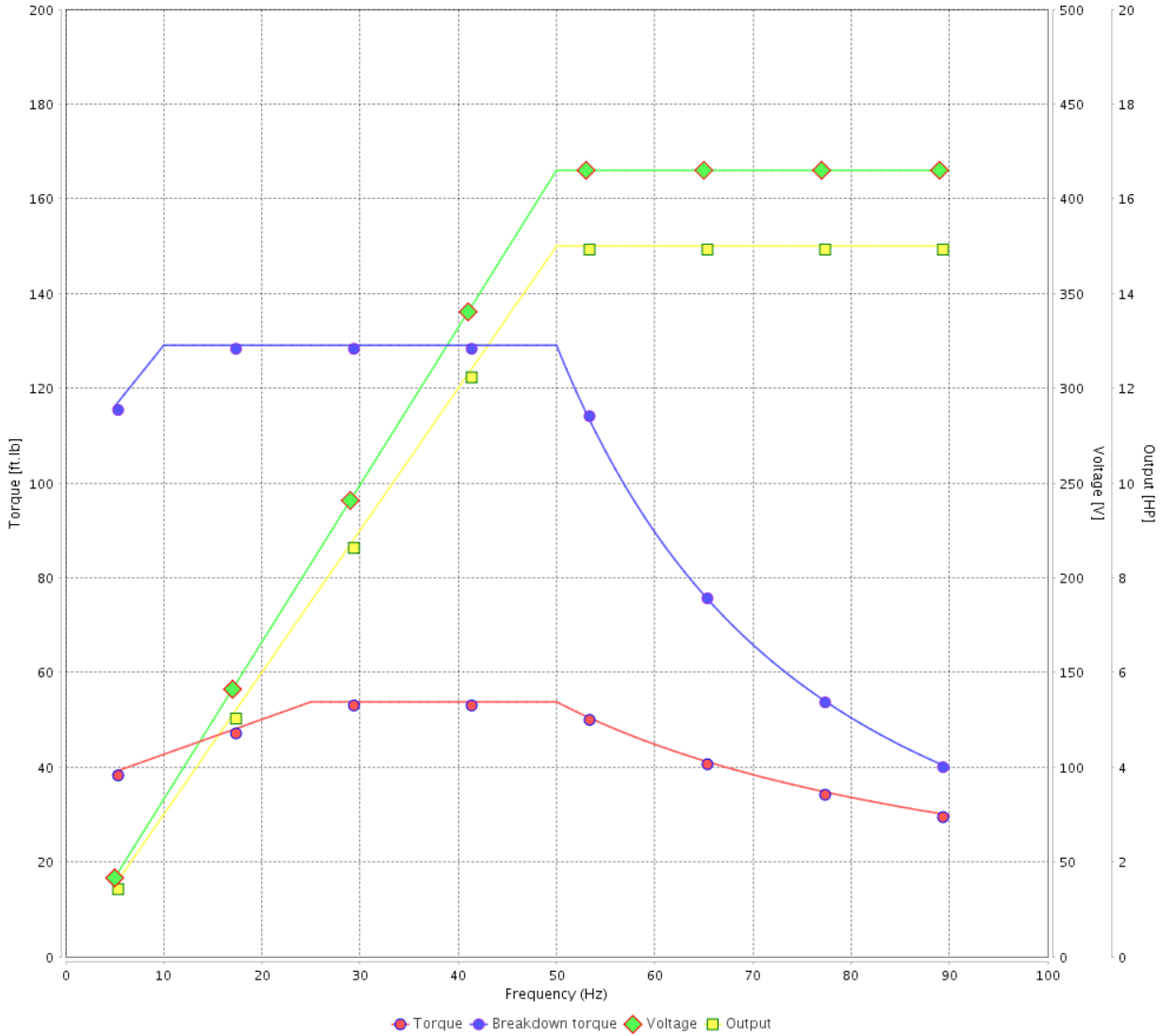

Performance : 415 V 50 Hz 4P IE2

Rated current : 20.0 A  
 LRC : 5.9  
 Rated torque : 53.8 ft.lb  
 Locked rotor torque : 210 %  
 Breakdown torque : 240 %  
 Rated speed : 1465 rpm

Moment of inertia (J) : 2.62 sq.ft.lb  
 Duty cycle : Cont.(S1)  
 Insulation class : F  
 Service factor : 1.00  
 Temperature rise : 80 K  
 Design : B

Rev.	Changes Summary	Performed	Checked	Date
Performed by			Page 36 / 36	Revision
Checked by				
Date	13/04/2022			

1 2 3 4 5 6

A

B

C

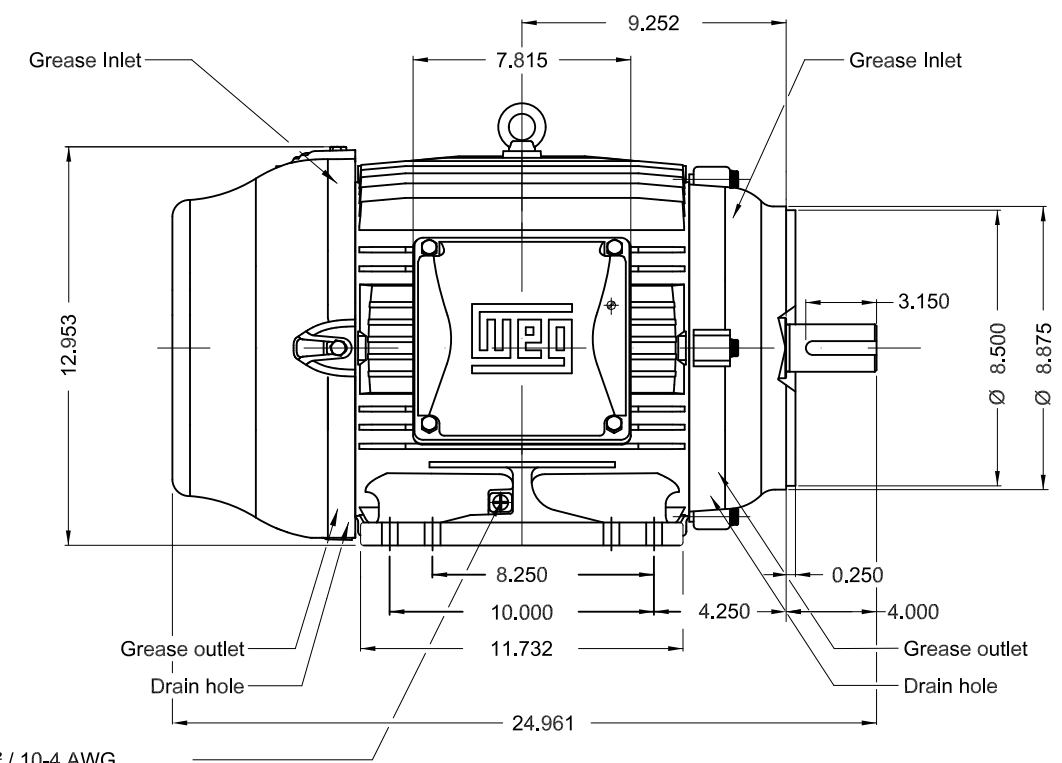
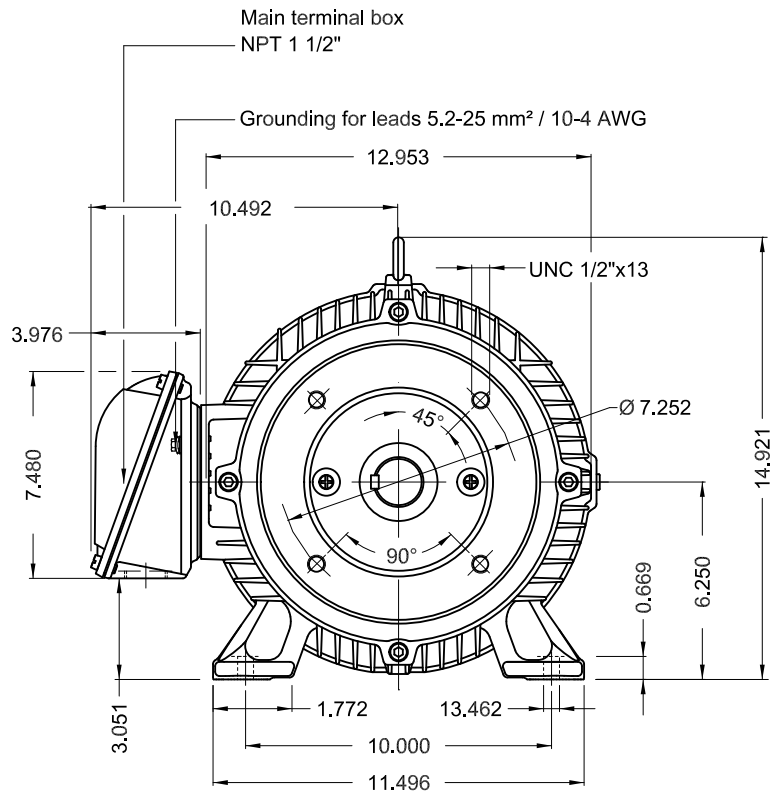

Grounding for leads 5.2-25 mm² / 10-4 AWG

D

E

Without vertical jackscrews  
 Color RAL 5009  
 Painting plan 202E  
 Mounting B34R(D)

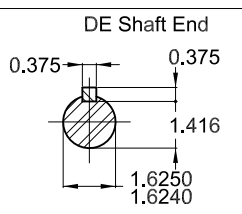

15 HP 04 Poles 60 Hz A

ECM	LOC	SUMMARY OF MODIFICATIONS	EXECUTED	CHECKED	RELEASED	DATE	VER
EXECUTED	PIRWBUSER	THREE PH. MOTOR IEEE 841 W22 PREM. EFF.					
CHECKED		FRAME 254/6TC IP55 TEFC					
RELEASED							
REL DT.	WMO	Jaragua do Sul	Product Engineering	SHEET	1 / 1		

PREVIEW  
 WDD



Dimensions in inches XME A3



**NEMA**  
Premium  
W22



FOR SAFE AREA  
Mod.TE1BFOXON  
CC029A



Class I, Div 2, Gr A, B, C and D - T3  
Class I, Zone 2, IIC - T3  
Class II, Div 2, Gr F and G - T4  
For use on PWM: Gr. A, B, C, D and F,  
VT 1000:1, CT 20:1, 1.00SF - T3A

MODEL 01518ST3QIE254TC-W22



Inverter Duty Motor  
Severe Duty

MADE IN BRAZIL  
12385114

PH3 60Hz Fr. 254/6TC 1000m.a.s.l. IP55 TEFC 299lb

V 460

A 18.0

HP 15

kW 11

SF 1.25

SFA 22.5

RPM 1768

PF 0.83

AMB 40°C

INS cl. F DT80K

NEMA NOM EFF 92.4%

DUTY CONT.

DES B Code G

GUARANT. EFF 91.0%

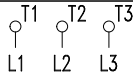

460V



→ 6309-C3 (13g) 45BC03X30

→ 6209-C3 (9g) 45BC02X30



MOBIL POLYREX EM (20000h)

