

# DATA SHEET

## Three Phase Induction Motor - Squirrel Cage



Customer					
Product line		: NEMA Premium Efficiency Three-Phase	Product code :		14407394
			Catalog # :		01518XT3ER254TC
Frame		: 254TC	Cooling method		: IC411 - TEFC
Insulation class		: F	Mounting		: W-6
Duty cycle		: Cont.(S1)	Rotation <sup>1</sup>		: Both (CW and CCW)
Ambient temperature		: -20°C to +40°C	Starting method		: Direct On Line
Altitude		: 1000 m.a.s.l.	Approx. weight <sup>2</sup>		: 338 lb
Protection degree		: IP55	Moment of inertia (J)		: 2.31 sq.ft.lb
Design		: B			
Output [HP]	15	15	15	15	
Poles	4	4	4	4	
Frequency [Hz]	60	50	50	50	
Rated voltage [V]	230/460	380	400	415	
Rated current [A]	36.8/18.4	22.1	21.3	20.8	
L. R. Amperes [A]	269/134	128	136	141	
LRC [A]	7.3x(Code J)	5.8x(Code G)	6.4x(Code G)	6.8x(Code H)	
No load current [A]	17.2/8.60	8.40	9.20	9.60	
Rated speed [RPM]	1770	1455	1460	1465	
Slip [%]	1.67	3.00	2.67	2.33	
Rated torque [ft.lb]	44.5	54.1	54.0	53.8	
Locked rotor torque [%]	300	220	250	270	
Breakdown torque [%]	300	229	250	270	
Service factor	1.15	1.00	1.00	1.00	
Temperature rise	80 K	80 K	80 K	80 K	
Locked rotor time	46s (cold) 26s (hot)	45s (cold) 25s (hot)	45s (cold) 25s (hot)	45s (cold) 25s (hot)	
Noise level <sup>2</sup>	69.0 dB(A)	67.0 dB(A)	67.0 dB(A)	67.0 dB(A)	
Efficiency (%)	25%	89.4	92.1	91.4	90.8
	50%	90.2	91.0	91.0	91.0
	75%	91.7	91.7	91.7	91.0
	100%	92.4	90.2	91.0	91.0
Power Factor	25%	0.39	0.45	0.42	0.39
	50%	0.65	0.71	0.68	0.64
	75%	0.75	0.79	0.77	0.75
	100%	0.81	0.84	0.82	0.81
Bearing type		Drive end : 6309 C3	Non drive end : 6209 C3	Foundation loads	
Sealing		: Oil Seal	: Lip Seal	Max. traction : 527 lb	
Lubrication interval		: 14395 h	: 15700 h	Max. compression : 865 lb	
Lubricant amount		: 13 g	: 9 g		
Lubricant type		: Mobil Polyrex EM			
Notes					
USABLE @208V 40.7A SF 1.15 SFA 46.8A					
This revision replaces and cancel the previous one, which must be eliminated. (1) Looking the motor from the shaft end. (2) Measured at 1m and with tolerance of +3dB(A). (3) Approximate weight subject to changes after manufacturing process. (4) At 100% of full load.			These are average values based on tests with sinusoidal power supply, subject to the tolerances stipulated in NEMA MG-1.		
Rev.	Changes Summary		Performed	Checked	Date
Performed by					
Checked by				Page	Revision
Date	13/04/2022			1 / 22	

# DATA SHEET

## Three Phase Induction Motor - Squirrel Cage



Customer : \_\_\_\_\_

### Thermal protection

ID	Application	Type	Quantity	Sensing Temperature
1	Winding	Thermostat - 2 wires	1 x Phase	155 °C

Rev.	Changes Summary	Performed	Checked	Date
Performed by				
Checked by			Page	Revision
Date	13/04/2022		2 / 22	

# TORQUE AND CURRENT VS SPEED CURVE



## Three Phase Induction Motor - Squirrel Cage

Customer :

Product line : NEMA Premium Efficiency Three-Phase

Product code : 14407394

Catalog # : 01518XT3ER254TC

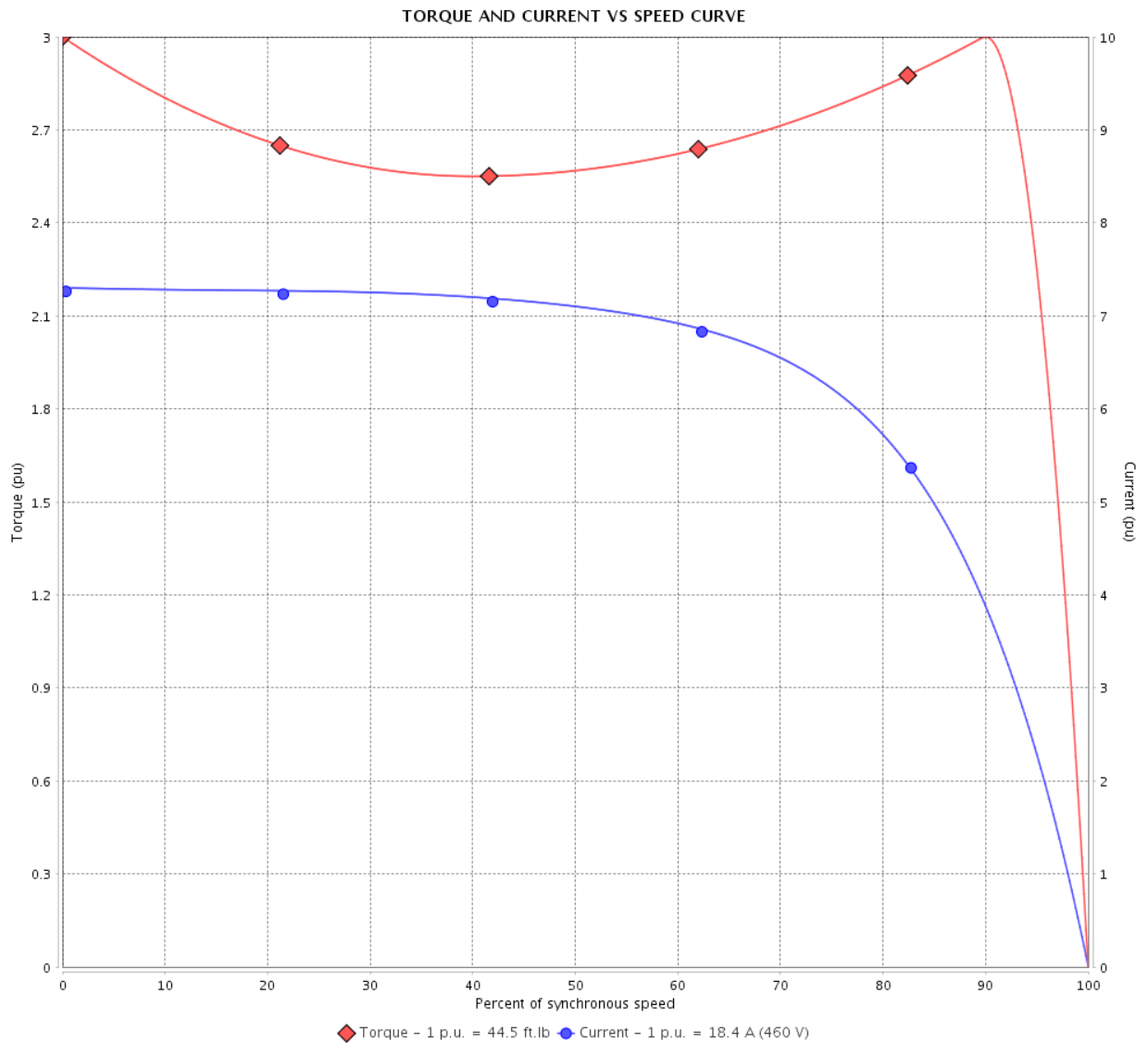

Performance : 230/460 V 60 Hz 4P

Rated current : 36.8/18.4 A  
 LRC : 7.3  
 Rated torque : 44.5 ft.lb  
 Locked rotor torque : 300 %  
 Breakdown torque : 300 %  
 Rated speed : 1770 rpm

Moment of inertia (J) : 2.31 sq.ft.lb  
 Duty cycle : Cont.(S1)  
 Insulation class : F  
 Service factor : 1.15  
 Temperature rise : 80 K  
 Design : B

Locked rotor time : 46s (cold) 26s (hot)

Rev.	Changes Summary	Performed	Checked	Date
Performed by			Page	Revision
Checked by			3 / 22	
Date	13/04/2022			

# TORQUE AND CURRENT VS SPEED CURVE

Three Phase Induction Motor - Squirrel Cage



Customer :

Product line : NEMA Premium Efficiency Three-Phase

Product code : 14407394

Catalog # : 01518XT3ER254TC

TORQUE AND CURRENT VS SPEED CURVE

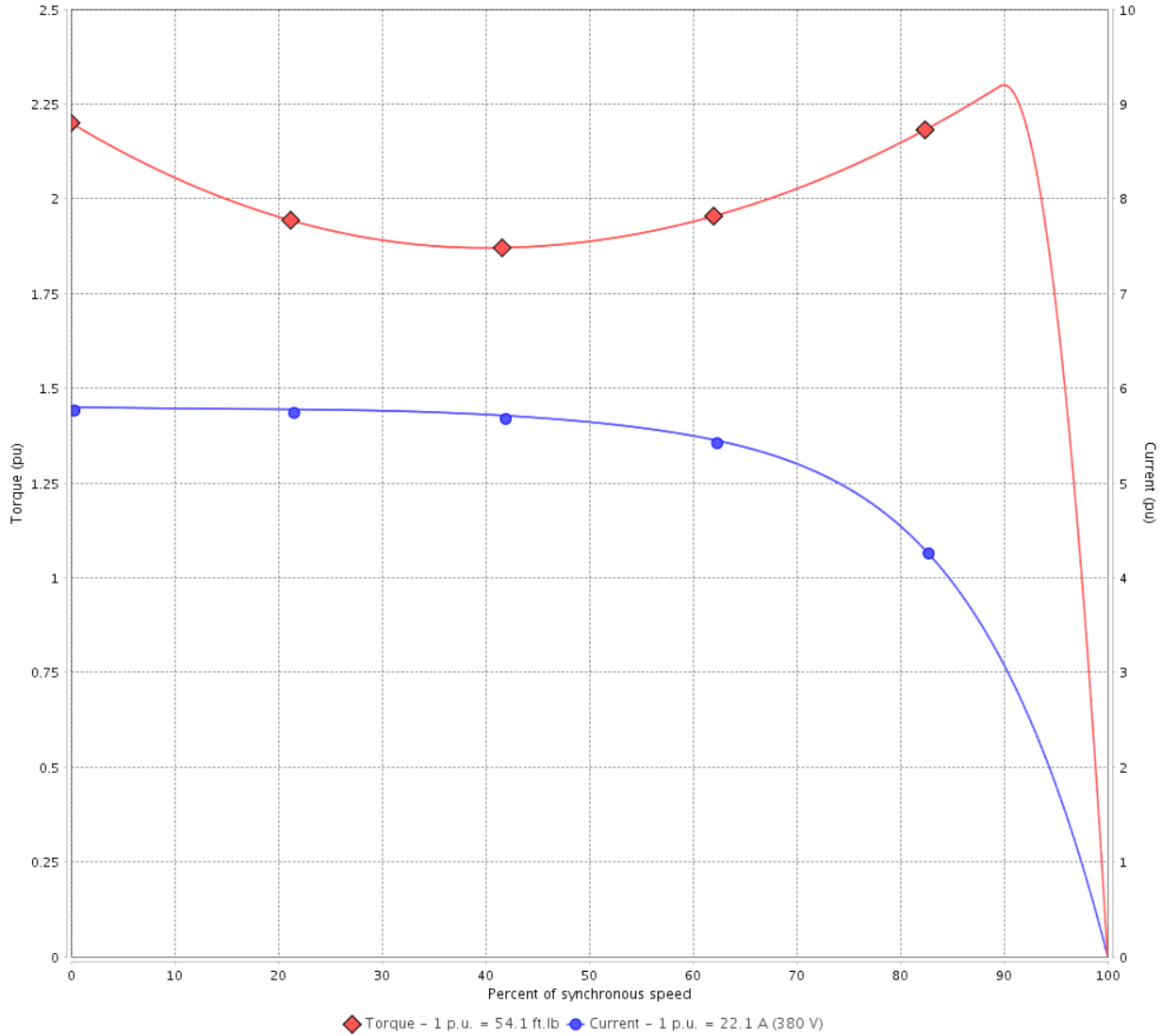

Performance : 380 V 50 Hz 4P IE2

Rated current	: 22.1 A	Moment of inertia (J)	: 2.31 sq.ft.lb
LRC	: 5.8	Duty cycle	: Cont.(S1)
Rated torque	: 54.1 ft.lb	Insulation class	: F
Locked rotor torque	: 220 %	Service factor	: 1.00
Breakdown torque	: 229 %	Temperature rise	: 80 K
Rated speed	: 1455 rpm	Design	: B

Locked rotor time : 45s (cold) 25s (hot)

Rev.	Changes Summary	Performed	Checked	Date
Performed by			Page 4 / 22	Revision
Checked by				
Date	13/04/2022			

# TORQUE AND CURRENT VS SPEED CURVE



## Three Phase Induction Motor - Squirrel Cage

Customer :

Product line : NEMA Premium Efficiency Three-Phase

Product code : 14407394

Catalog # : 01518XT3ER254TC

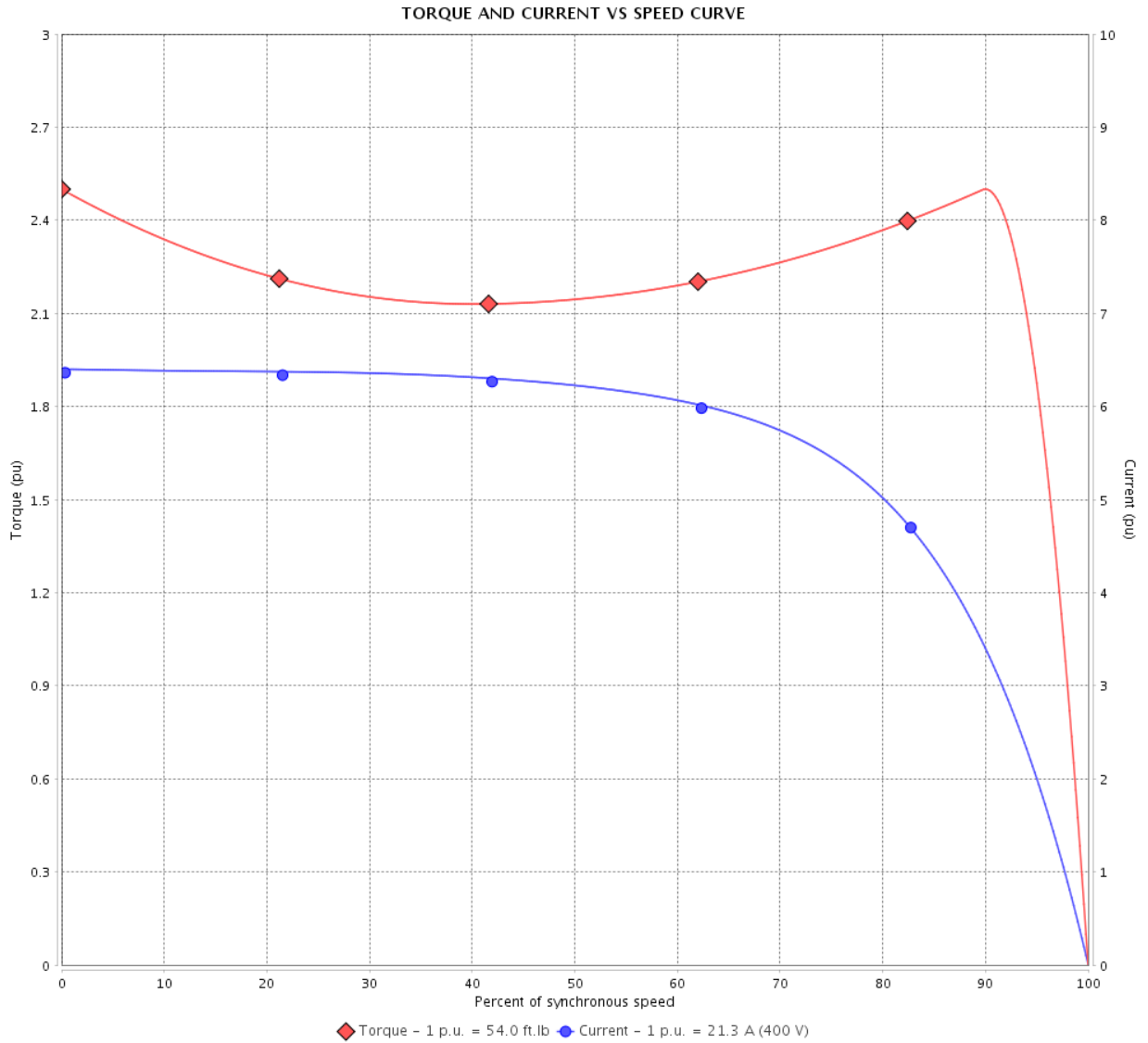

Performance : 400 V 50 Hz 4P IE2

Rated current	: 21.3 A	Moment of inertia (J)	: 2.31 sq.ft.lb
LRC	: 6.4	Duty cycle	: Cont.(S1)
Rated torque	: 54.0 ft.lb	Insulation class	: F
Locked rotor torque	: 250 %	Service factor	: 1.00
Breakdown torque	: 250 %	Temperature rise	: 80 K
Rated speed	: 1460 rpm	Design	: B

Locked rotor time : 45s (cold) 25s (hot)

Rev.	Changes Summary	Performed	Checked	Date
Performed by			Page 5 / 22	Revision
Checked by				
Date	13/04/2022			

# TORQUE AND CURRENT VS SPEED CURVE

Three Phase Induction Motor - Squirrel Cage



Customer :

Product line : NEMA Premium Efficiency Three-Phase

Product code : 14407394

Catalog # : 01518XT3ER254TC

TORQUE AND CURRENT VS SPEED CURVE

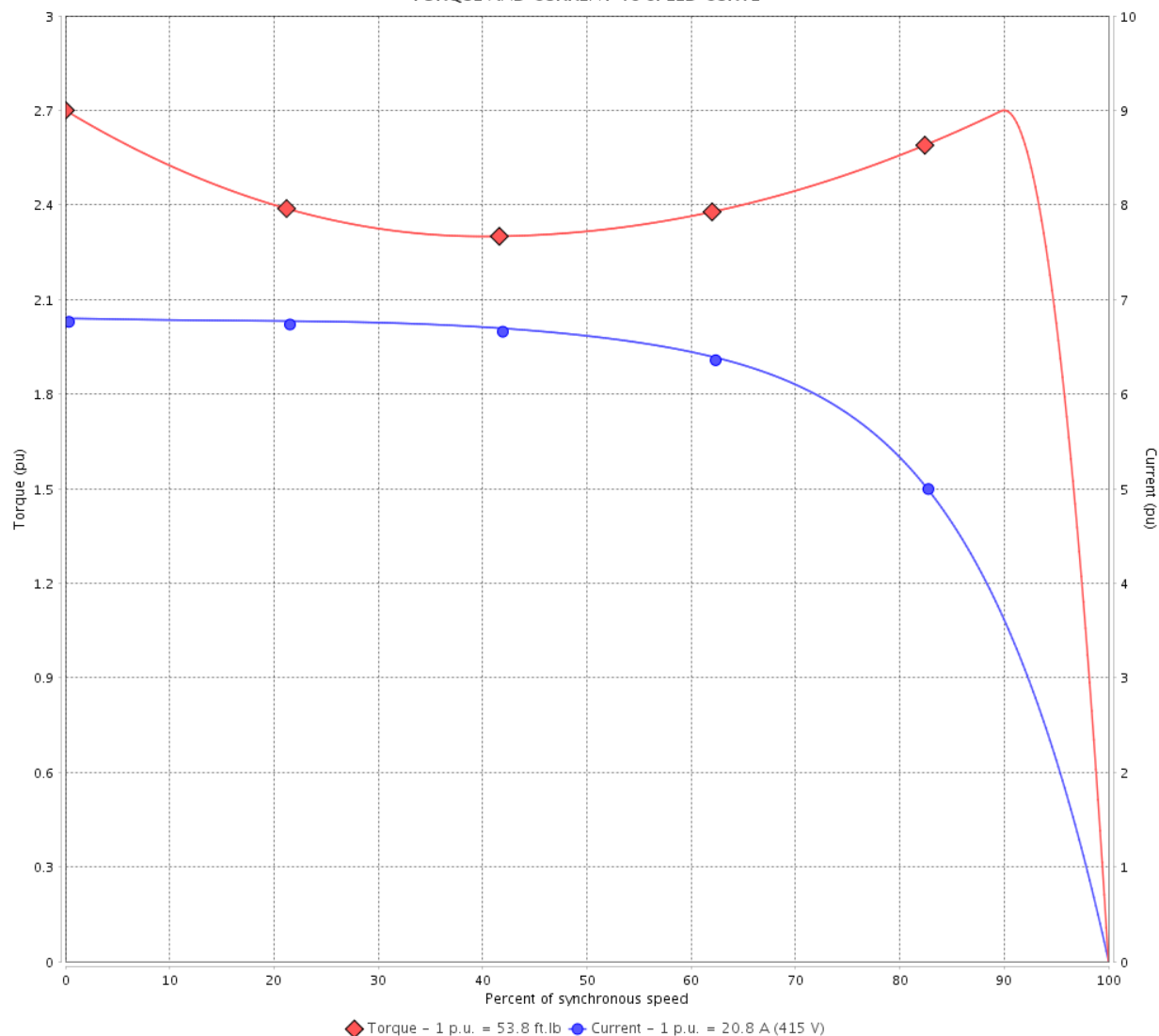

Performance : 415 V 50 Hz 4P IE2

Rated current	: 20.8 A	Moment of inertia (J)	: 2.31 sq.ft.lb
LRC	: 6.8	Duty cycle	: Cont.(S1)
Rated torque	: 53.8 ft.lb	Insulation class	: F
Locked rotor torque	: 270 %	Service factor	: 1.00
Breakdown torque	: 270 %	Temperature rise	: 80 K
Rated speed	: 1465 rpm	Design	: B

Locked rotor time : 45s (cold) 25s (hot)

Rev.	Changes Summary	Performed	Checked	Date
Performed by			Page 6 / 22	Revision
Checked by				
Date	13/04/2022			

# LOAD PERFORMANCE CURVE

## Three Phase Induction Motor - Squirrel Cage



Customer : \_\_\_\_\_

Product line : NEMA Premium Efficiency Three-Phase

Product code : 14407394

Catalog # : 01518XT3ER254TC

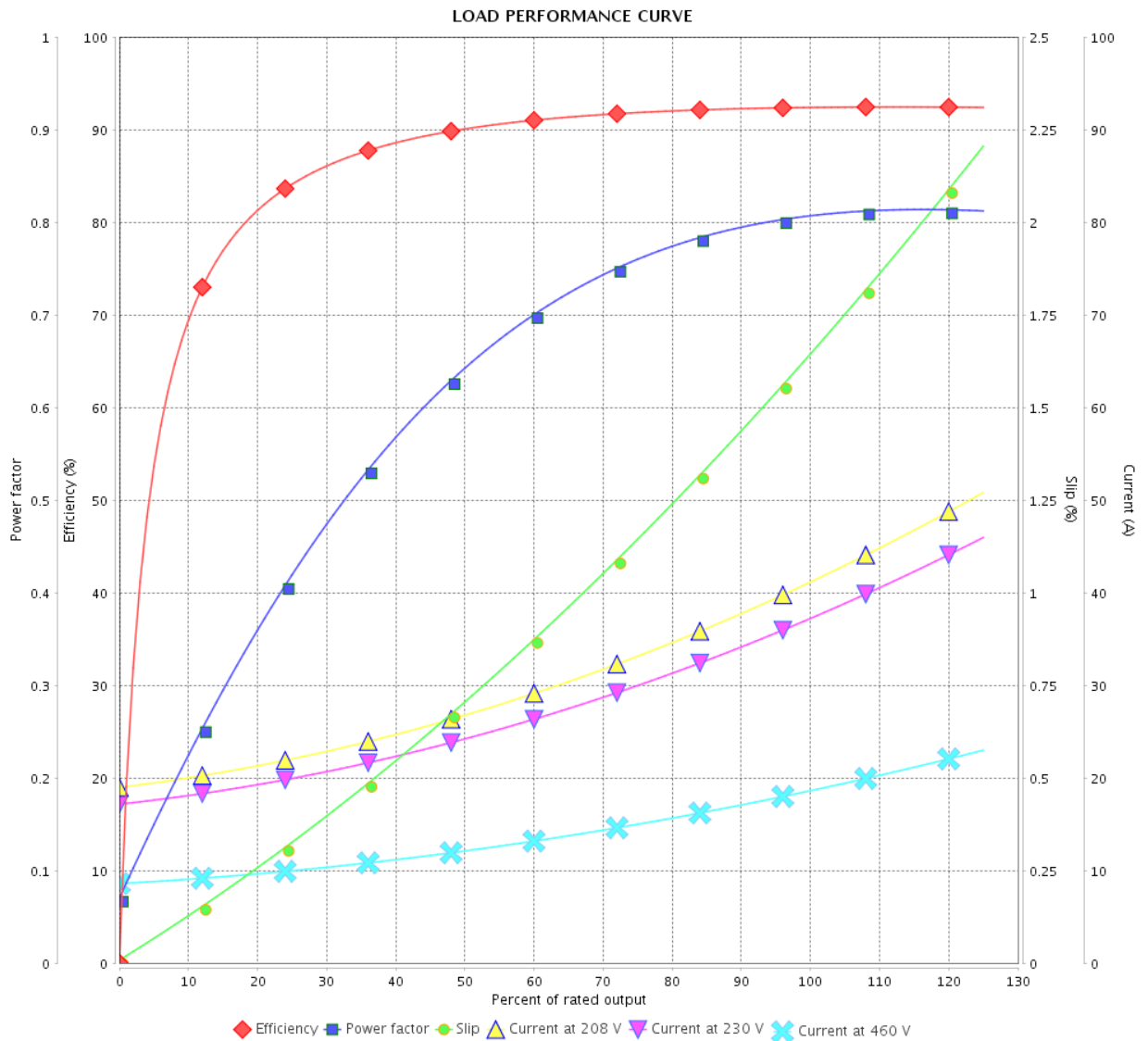

Performance : 230/460 V 60 Hz 4P

Rated current : 36.8/18.4 A  
 LRC : 7.3  
 Rated torque : 44.5 ft.lb  
 Locked rotor torque : 300 %  
 Breakdown torque : 300 %  
 Rated speed : 1770 rpm

Moment of inertia (J) : 2.31 sq.ft.lb  
 Duty cycle : Cont.(S1)  
 Insulation class : F  
 Service factor : 1.15  
 Temperature rise : 80 K  
 Design : B

Rev.	Changes Summary	Performed	Checked	Date
Performed by		Page		Revision
Checked by		7 / 22		
Date		13/04/2022		

# LOAD PERFORMANCE CURVE

Three Phase Induction Motor - Squirrel Cage



Customer :

Product line : NEMA Premium Efficiency Three-Phase

Product code : 14407394

Catalog # : 01518XT3ER254TC

LOAD PERFORMANCE CURVE

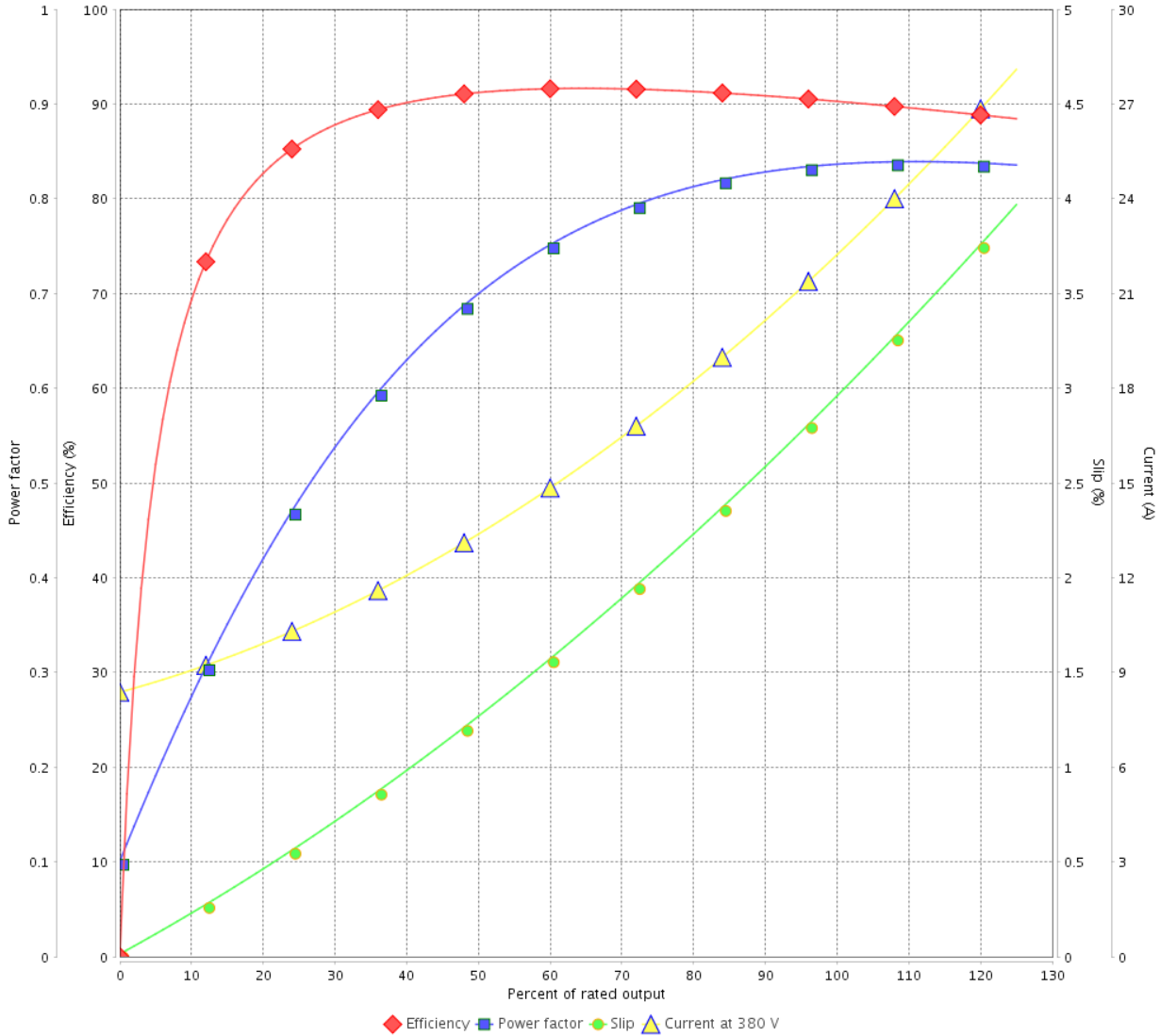

Performance : 380 V 50 Hz 4P IE2

Rated current : 22.1 A  
 LRC : 5.8  
 Rated torque : 54.1 ft.lb  
 Locked rotor torque : 220 %  
 Breakdown torque : 229 %  
 Rated speed : 1455 rpm

Moment of inertia (J) : 2.31 sq.ft.lb  
 Duty cycle : Cont.(S1)  
 Insulation class : F  
 Service factor : 1.00  
 Temperature rise : 80 K  
 Design : B

Rev.	Changes Summary	Performed	Checked	Date
Performed by			Page 8 / 22	Revision
Checked by				
Date	13/04/2022			



# LOAD PERFORMANCE CURVE

## Three Phase Induction Motor - Squirrel Cage



Customer :

Product line : NEMA Premium Efficiency Three-Phase

Product code : 14407394

Catalog # : 01518XT3ER254TC

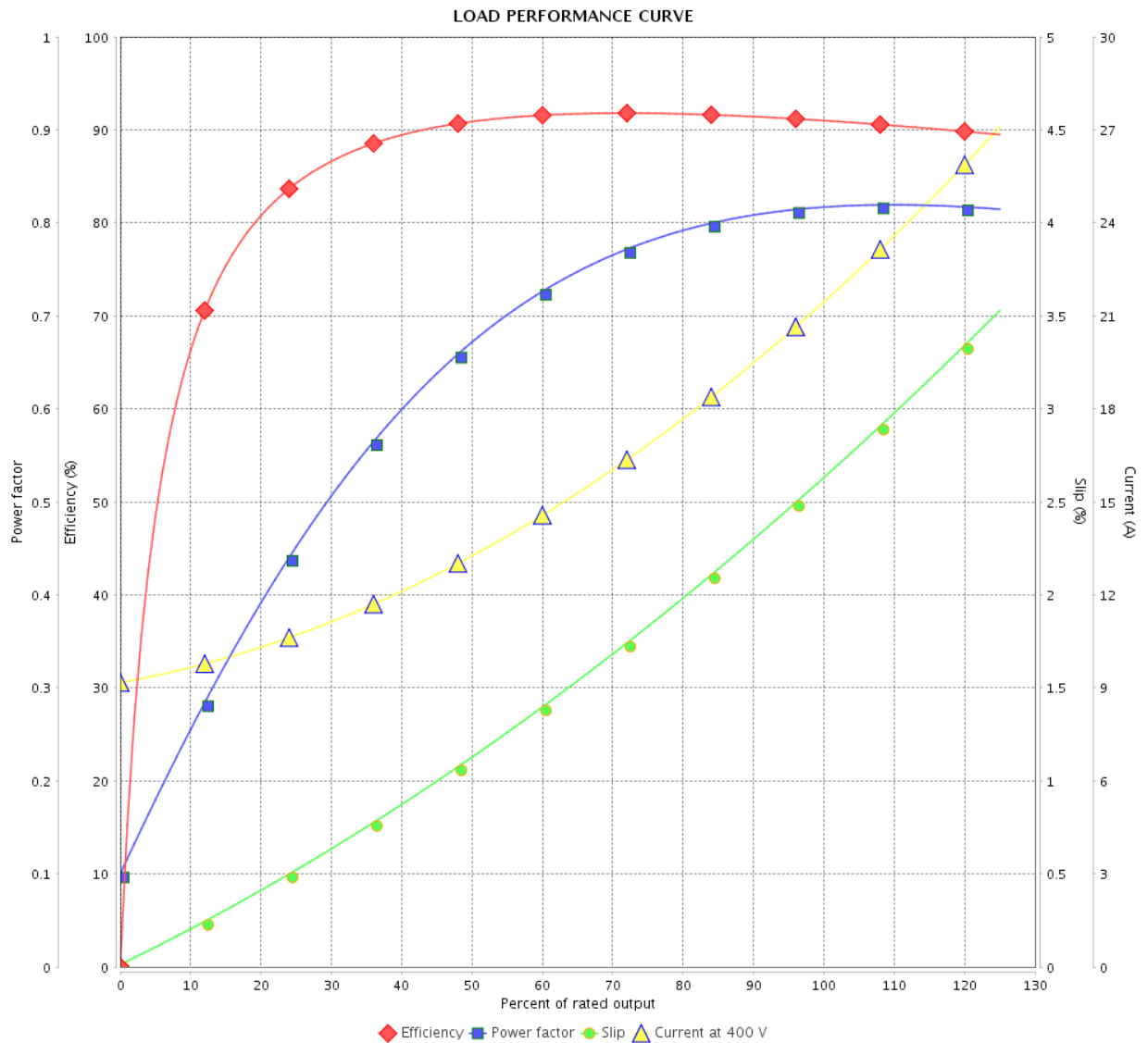

Performance : 400 V 50 Hz 4P IE2

Rated current : 21.3 A  
 LRC : 6.4  
 Rated torque : 54.0 ft.lb  
 Locked rotor torque : 250 %  
 Breakdown torque : 250 %  
 Rated speed : 1460 rpm

Moment of inertia (J) : 2.31 sq.ft.lb  
 Duty cycle : Cont.(S1)  
 Insulation class : F  
 Service factor : 1.00  
 Temperature rise : 80 K  
 Design : B

Rev.	Changes Summary	Performed	Checked	Date
Performed by		Page		Revision
Checked by		9 / 22		
Date		13/04/2022		

# LOAD PERFORMANCE CURVE

Three Phase Induction Motor - Squirrel Cage



Customer :

Product line : NEMA Premium Efficiency Three-Phase

Product code : 14407394

Catalog # : 01518XT3ER254TC

LOAD PERFORMANCE CURVE

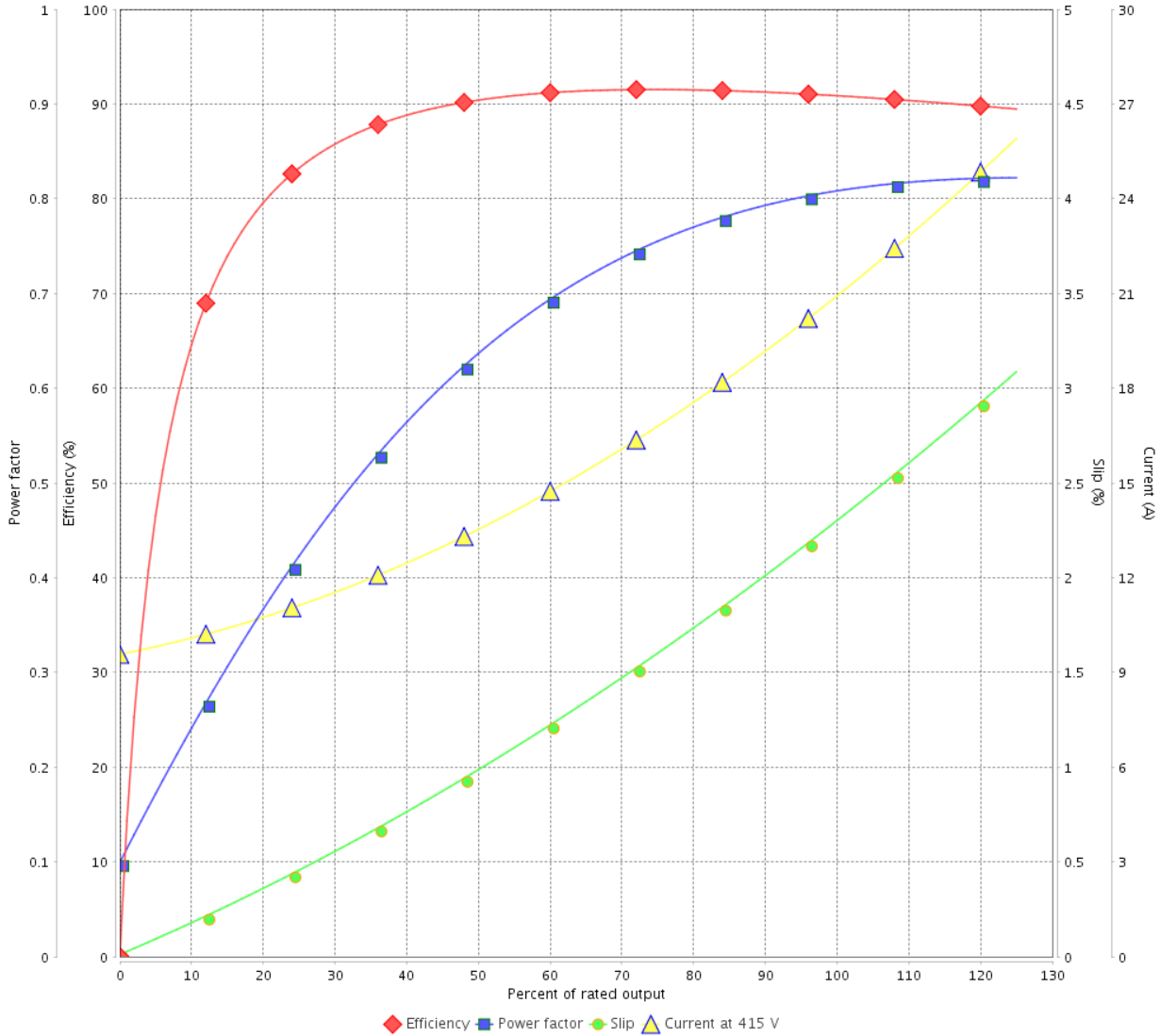

Performance : 415 V 50 Hz 4P IE2

Rated current : 20.8 A  
 LRC : 6.8  
 Rated torque : 53.8 ft.lb  
 Locked rotor torque : 270 %  
 Breakdown torque : 270 %  
 Rated speed : 1465 rpm

Moment of inertia (J) : 2.31 sq.ft.lb  
 Duty cycle : Cont.(S1)  
 Insulation class : F  
 Service factor : 1.00  
 Temperature rise : 80 K  
 Design : B

Rev.	Changes Summary	Performed	Checked	Date
Performed by			Page 10 / 22	Revision
Checked by				
Date	13/04/2022			

# THERMAL LIMIT CURVE



## Three Phase Induction Motor - Squirrel Cage

Customer :

Product line : NEMA Premium Efficiency Three-Phase  
 Product code : 14407394  
 Catalog # : 01518XT3ER254TC

Performance : 230/460 V 60 Hz 4P

Rated current : 36.8/18.4 A	Moment of inertia (J) : 2.31 sq.ft.lb
LRC : 7.3	Duty cycle : Cont.(S1)
Rated torque : 44.5 ft.lb	Insulation class : F
Locked rotor torque : 300 %	Service factor : 1.15
Breakdown torque : 300 %	Temperature rise : 80 K
Rated speed : 1770 rpm	Design : B

Heating constant

Cooling constant

Rev.	Changes Summary	Performed	Checked	Date
Performed by			Page 11 / 22	Revision
Checked by				
Date	13/04/2022			

# THERMAL LIMIT CURVE

Three Phase Induction Motor - Squirrel Cage



Customer : \_\_\_\_\_

THERMAL LIMIT CURVE

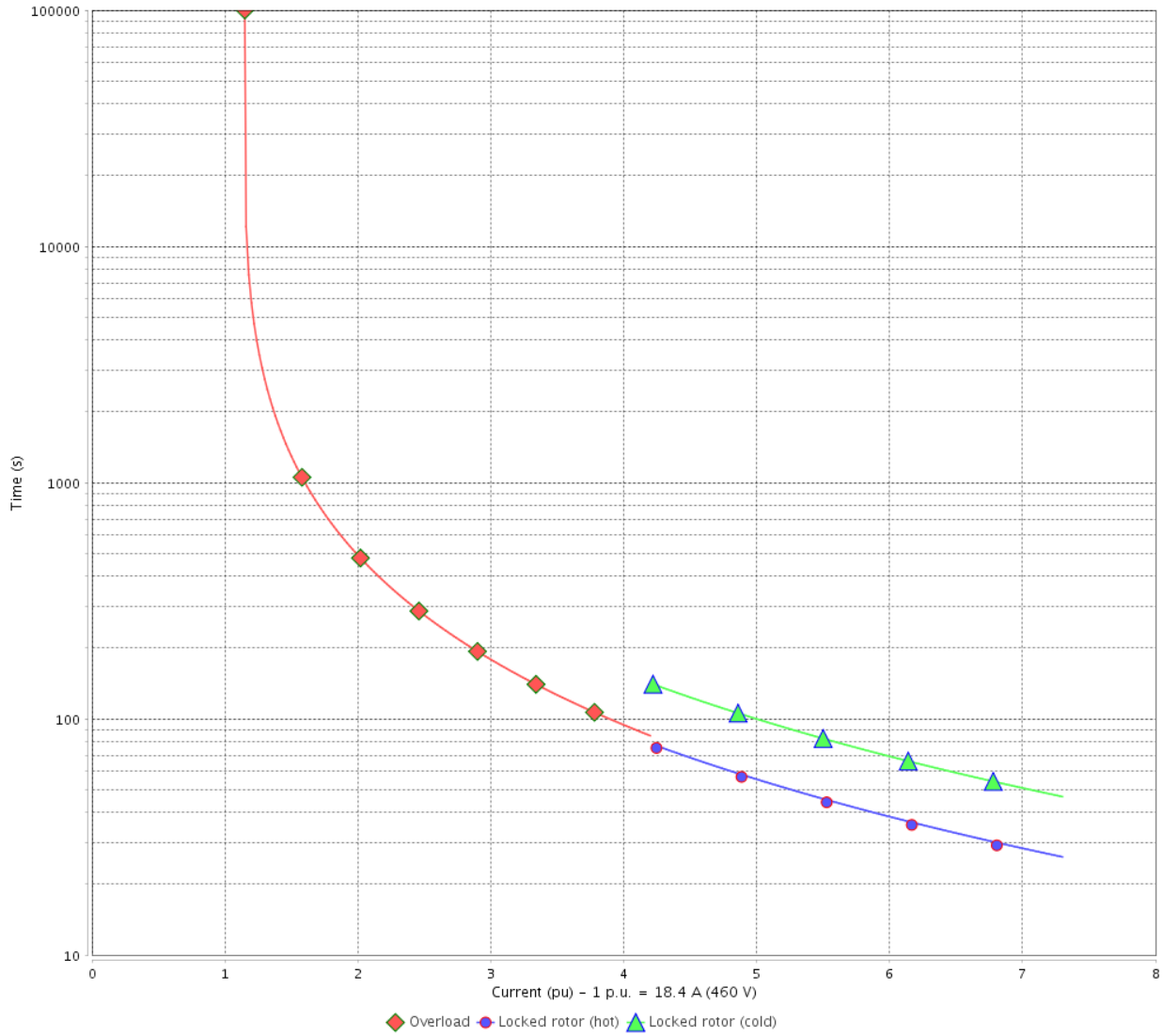

Rev.	Changes Summary	Performed	Checked	Date
Performed by		Page		Revision
Checked by		12 / 22		
Date	13/04/2022			

# THERMAL LIMIT CURVE



## Three Phase Induction Motor - Squirrel Cage

Customer :

Product line : NEMA Premium Efficiency Three-Phase  
 Product code : 14407394  
 Catalog # : 01518XT3ER254TC

Performance : 380 V 50 Hz 4P IE2

Rated current : 22.1 A	Moment of inertia (J) : 2.31 sq.ft.lb
LRC : 5.8	Duty cycle : Cont.(S1)
Rated torque : 54.1 ft.lb	Insulation class : F
Locked rotor torque : 220 %	Service factor : 1.00
Breakdown torque : 229 %	Temperature rise : 80 K
Rated speed : 1455 rpm	Design : B

Heating constant

Cooling constant

Rev.	Changes Summary	Performed	Checked	Date
Performed by			Page	Revision
Checked by				
Date	13/04/2022			

# THERMAL LIMIT CURVE

Three Phase Induction Motor - Squirrel Cage



Customer : \_\_\_\_\_

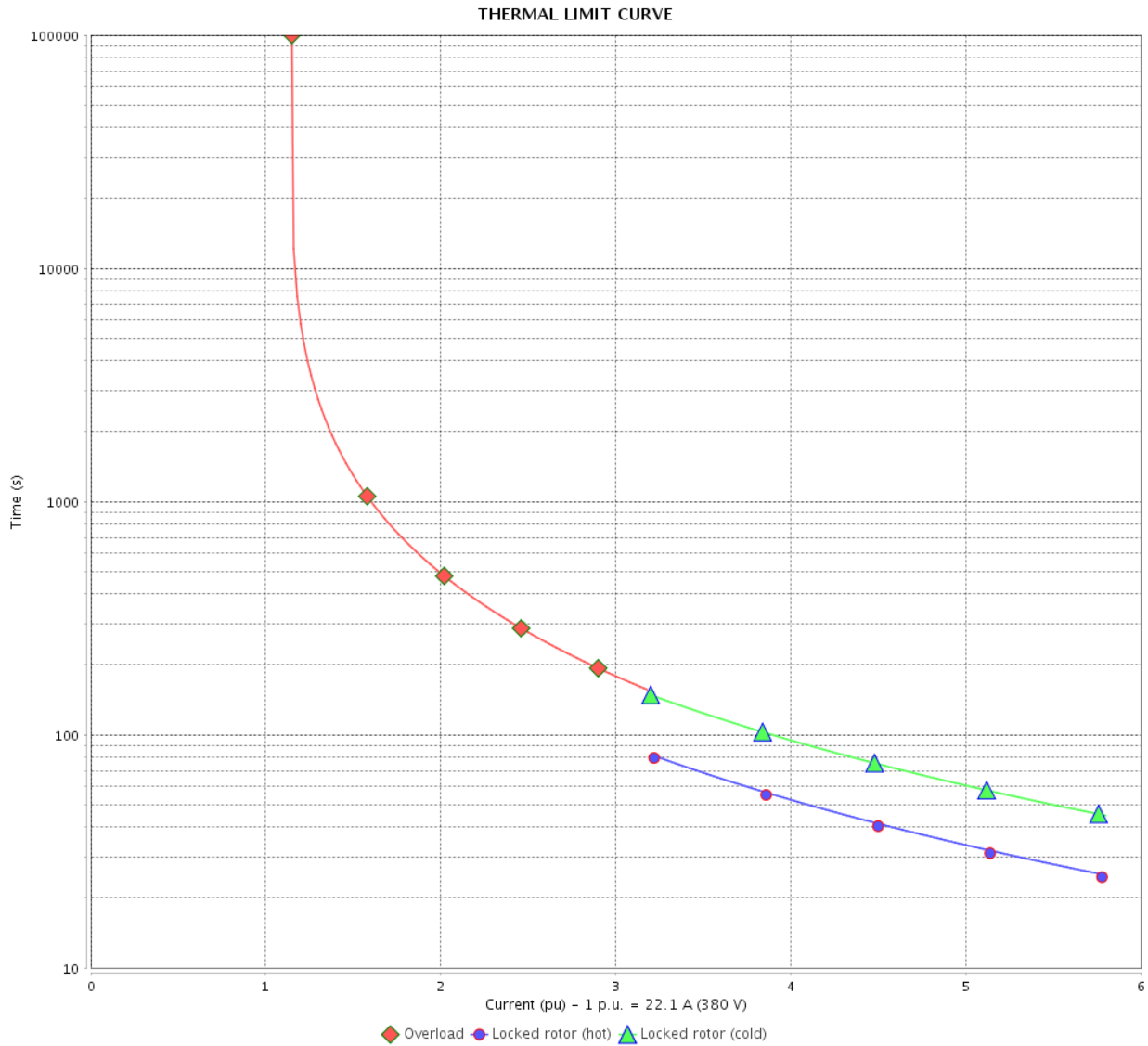

Rev.	Changes Summary	Performed	Checked	Date
Performed by		Page 14 / 22		Revision
Checked by				
Date				

# THERMAL LIMIT CURVE



## Three Phase Induction Motor - Squirrel Cage

Customer :

Product line : NEMA Premium Efficiency Three-Phase

Product code : 14407394

Catalog # : 01518XT3ER254TC

Performance : 400 V 50 Hz 4P IE2

Rated current : 21.3 A  
 LRC : 6.4  
 Rated torque : 54.0 ft.lb  
 Locked rotor torque : 250 %  
 Breakdown torque : 250 %  
 Rated speed : 1460 rpm

Moment of inertia (J) : 2.31 sq.ft.lb  
 Duty cycle : Cont.(S1)  
 Insulation class : F  
 Service factor : 1.00  
 Temperature rise : 80 K  
 Design : B

Heating constant

Cooling constant

Rev.	Changes Summary	Performed	Checked	Date
Performed by				
Checked by			Page	Revision
Date	13/04/2022		15 / 22	

# THERMAL LIMIT CURVE

Three Phase Induction Motor - Squirrel Cage



Customer : \_\_\_\_\_

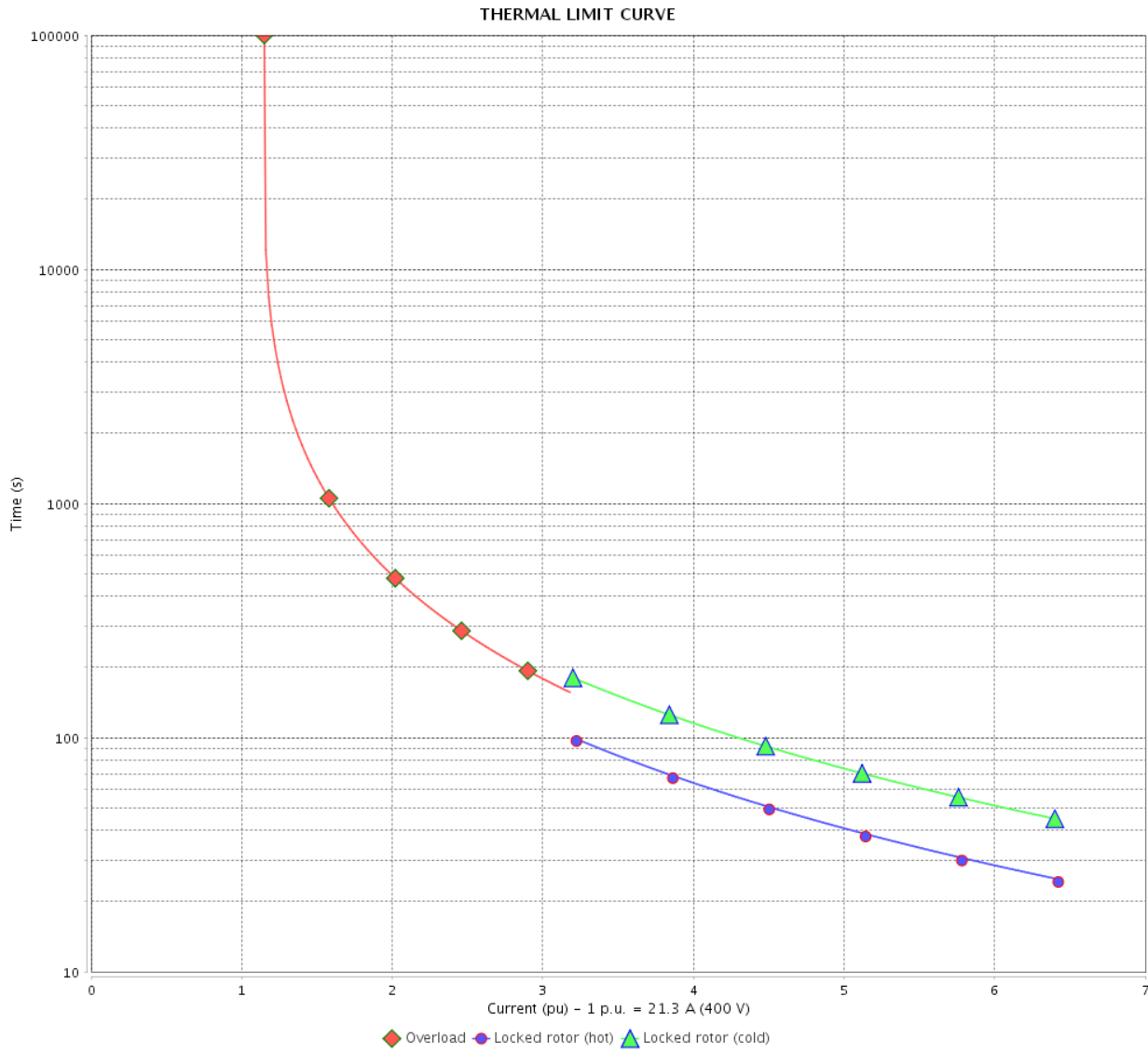

Rev.	Changes Summary	Performed	Checked	Date
Performed by		Page		Revision
Checked by		16 / 22		
Date		13/04/2022		



# THERMAL LIMIT CURVE



## Three Phase Induction Motor - Squirrel Cage

Customer :

Product line : NEMA Premium Efficiency Three-Phase  
 Product code : 14407394  
 Catalog # : 01518XT3ER254TC

Performance : 415 V 50 Hz 4P IE2

Rated current : 20.8 A	Moment of inertia (J) : 2.31 sq.ft.lb
LRC : 6.8	Duty cycle : Cont.(S1)
Rated torque : 53.8 ft.lb	Insulation class : F
Locked rotor torque : 270 %	Service factor : 1.00
Breakdown torque : 270 %	Temperature rise : 80 K
Rated speed : 1465 rpm	Design : B

Heating constant

Cooling constant

Rev.	Changes Summary	Performed	Checked	Date
Performed by			Page	Revision
Checked by				
Date	13/04/2022			

# THERMAL LIMIT CURVE

Three Phase Induction Motor - Squirrel Cage



Customer : \_\_\_\_\_

THERMAL LIMIT CURVE

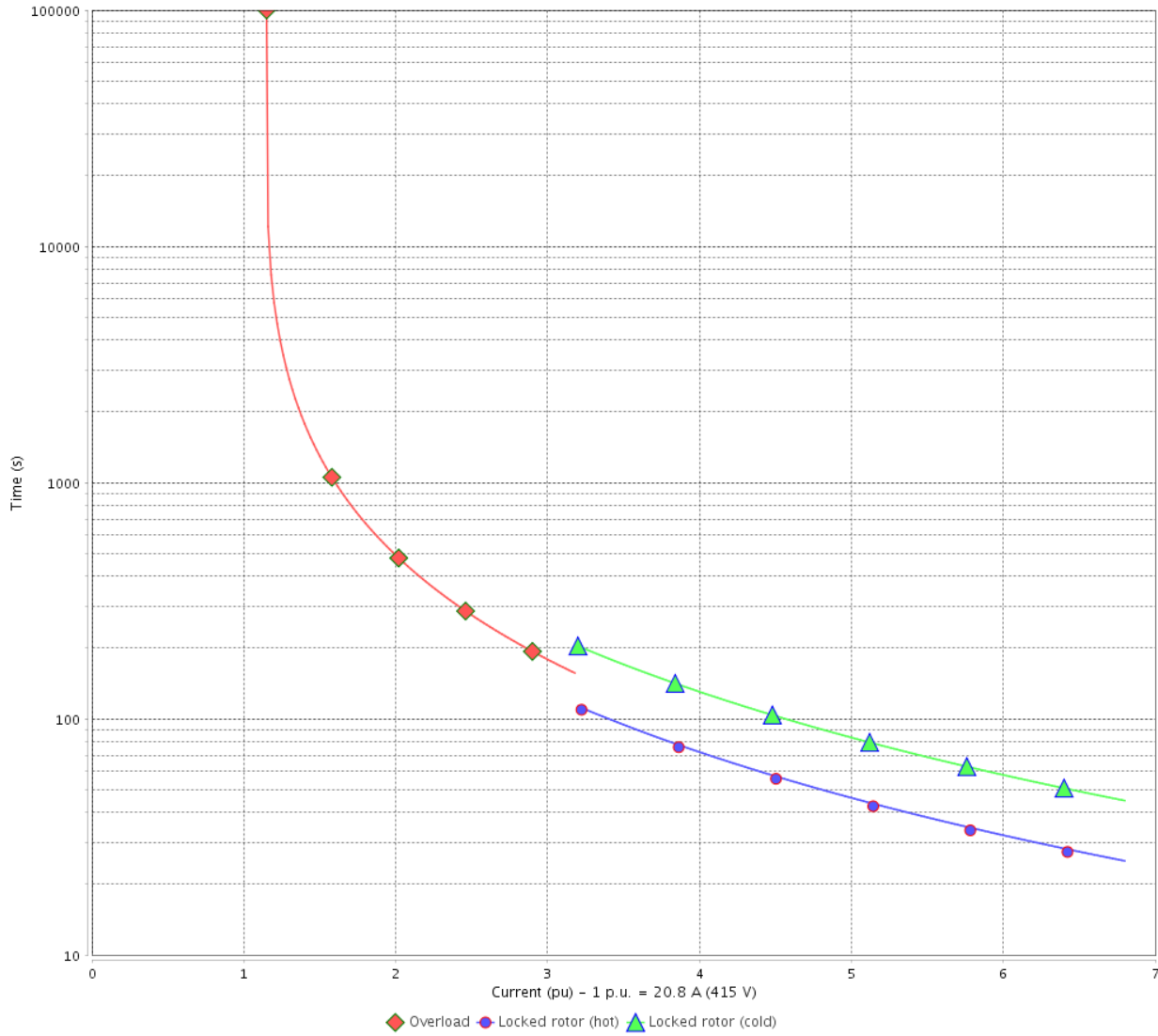

Rev.	Changes Summary	Performed	Checked	Date
Performed by		Page		Revision
Checked by		18 / 22		
Date		13/04/2022		

# VFD OPERATION CURVE

## Three Phase Induction Motor - Squirrel Cage



Customer : \_\_\_\_\_

Product line : NEMA Premium Efficiency Three-Phase

Product code : 14407394

Catalog # : 01518XT3ER254TC

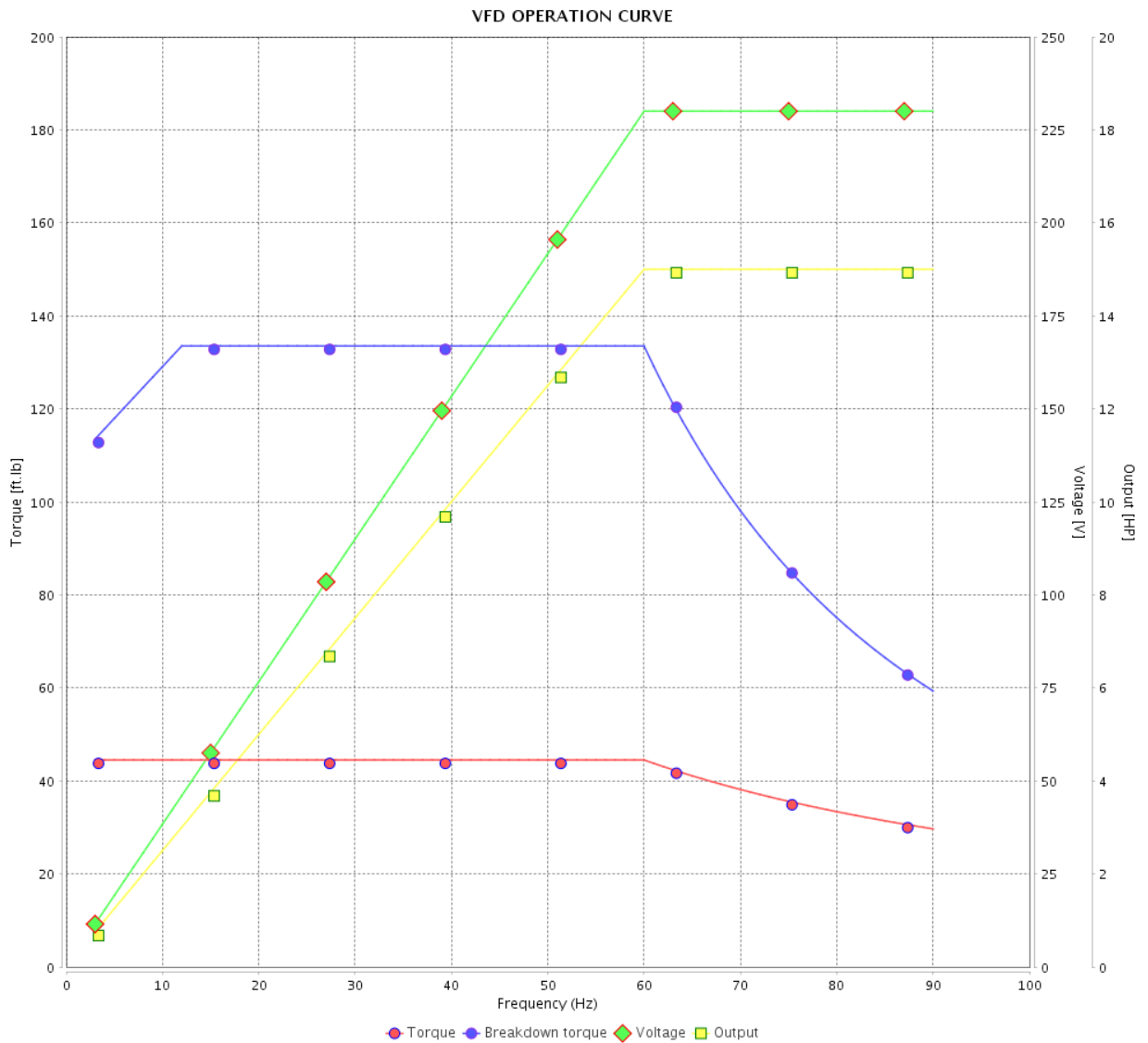

Performance : 230/460 V 60 Hz 4P

Rated current : 36.8/18.4 A  
 LRC : 7.3  
 Rated torque : 44.5 ft.lb  
 Locked rotor torque : 300 %  
 Breakdown torque : 300 %  
 Rated speed : 1770 rpm

Moment of inertia (J) : 2.31 sq.ft.lb  
 Duty cycle : Cont.(S1)  
 Insulation class : F  
 Service factor : 1.15  
 Temperature rise : 80 K  
 Design : B

Rev.	Changes Summary	Performed	Checked	Date
Performed by			Page	Revision
Checked by				
Date				

# VFD OPERATION CURVE

Three Phase Induction Motor - Squirrel Cage



Customer :

Product line : NEMA Premium Efficiency Three-Phase

Product code : 14407394

Catalog # : 01518XT3ER254TC

VFD OPERATION CURVE

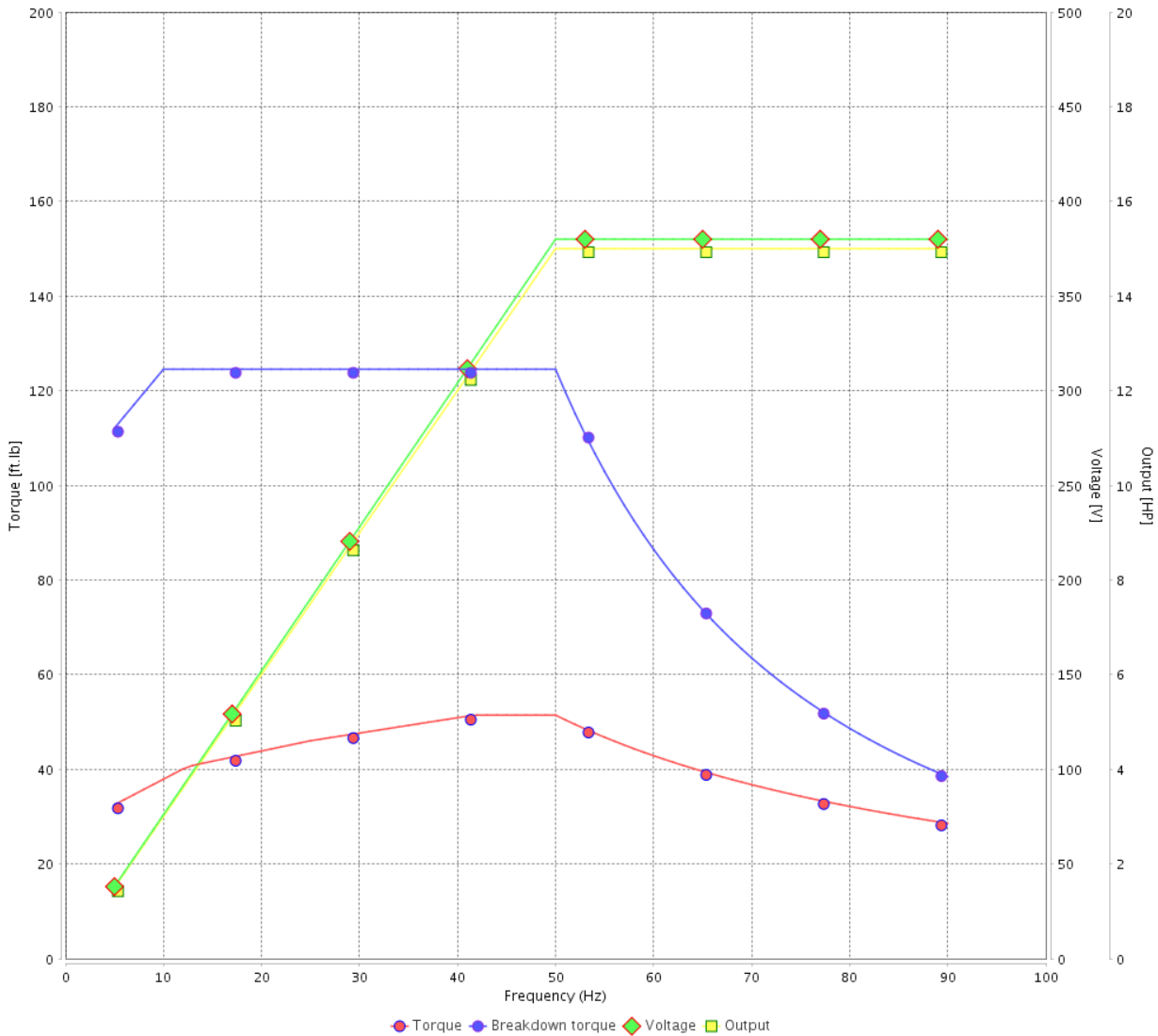

Performance : 380 V 50 Hz 4P IE2

Rated current : 22.1 A  
 LRC : 5.8  
 Rated torque : 54.1 ft.lb  
 Locked rotor torque : 220 %  
 Breakdown torque : 229 %  
 Rated speed : 1455 rpm

Moment of inertia (J) : 2.31 sq.ft.lb  
 Duty cycle : Cont.(S1)  
 Insulation class : F  
 Service factor : 1.00  
 Temperature rise : 80 K  
 Design : B

Rev.	Changes Summary	Performed	Checked	Date
Performed by			Page 20 / 22	Revision
Checked by				
Date	13/04/2022			

# VFD OPERATION CURVE

Three Phase Induction Motor - Squirrel Cage



Customer :

Product line : NEMA Premium Efficiency Three-Phase

Product code : 14407394

Catalog # : 01518XT3ER254TC

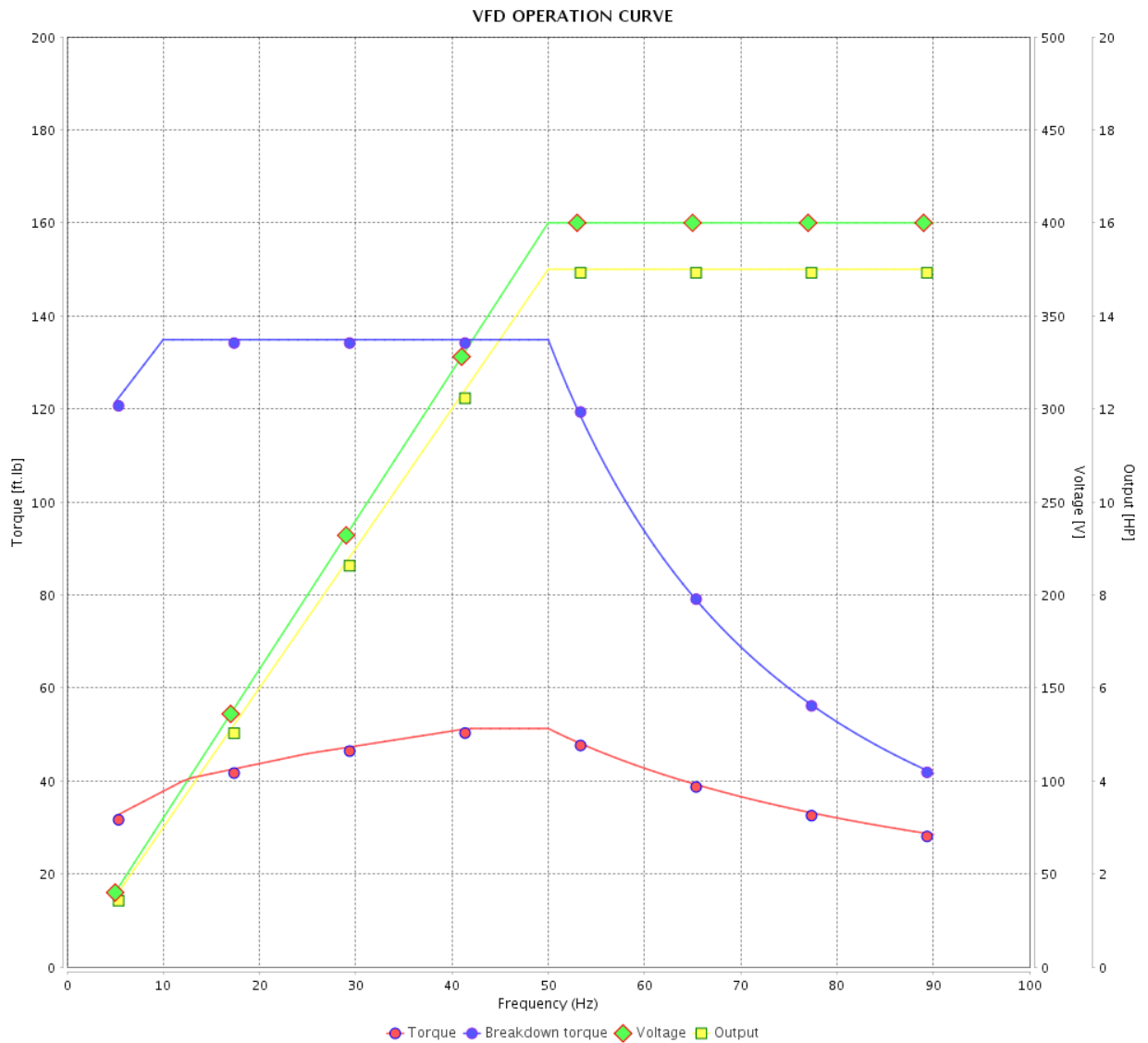

Performance : 400 V 50 Hz 4P IE2

Rated current : 21.3 A  
 LRC : 6.4  
 Rated torque : 54.0 ft.lb  
 Locked rotor torque : 250 %  
 Breakdown torque : 250 %  
 Rated speed : 1460 rpm

Moment of inertia (J) : 2.31 sq.ft.lb  
 Duty cycle : Cont.(S1)  
 Insulation class : F  
 Service factor : 1.00  
 Temperature rise : 80 K  
 Design : B

Rev.	Changes Summary	Performed	Checked	Date
Performed by		Page		Revision
Checked by		21 / 22		
Date		13/04/2022		

# VFD OPERATION CURVE

Three Phase Induction Motor - Squirrel Cage



Customer :

Product line : NEMA Premium Efficiency Three-Phase

Product code : 14407394

Catalog # : 01518XT3ER254TC

VFD OPERATION CURVE

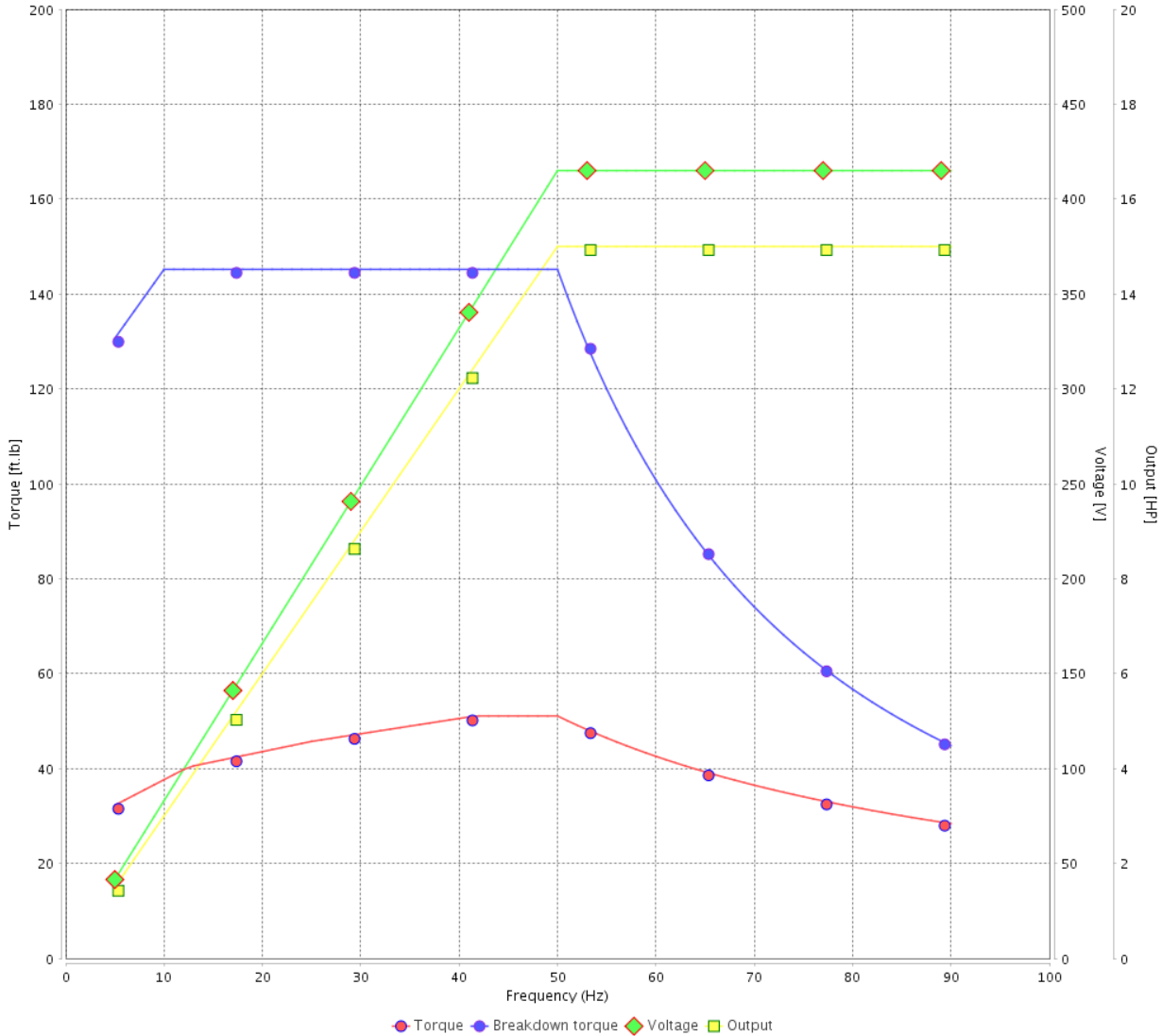

Performance : 415 V 50 Hz 4P IE2

Rated current	: 20.8 A	Moment of inertia (J)	: 2.31 sq.ft.lb
LRC	: 6.8	Duty cycle	: Cont.(S1)
Rated torque	: 53.8 ft.lb	Insulation class	: F
Locked rotor torque	: 270 %	Service factor	: 1.00
Breakdown torque	: 270 %	Temperature rise	: 80 K
Rated speed	: 1465 rpm	Design	: B

Rev.	Changes Summary	Performed	Checked	Date
Performed by		Page		Revision
Checked by		22 / 22		
Date	13/04/2022			

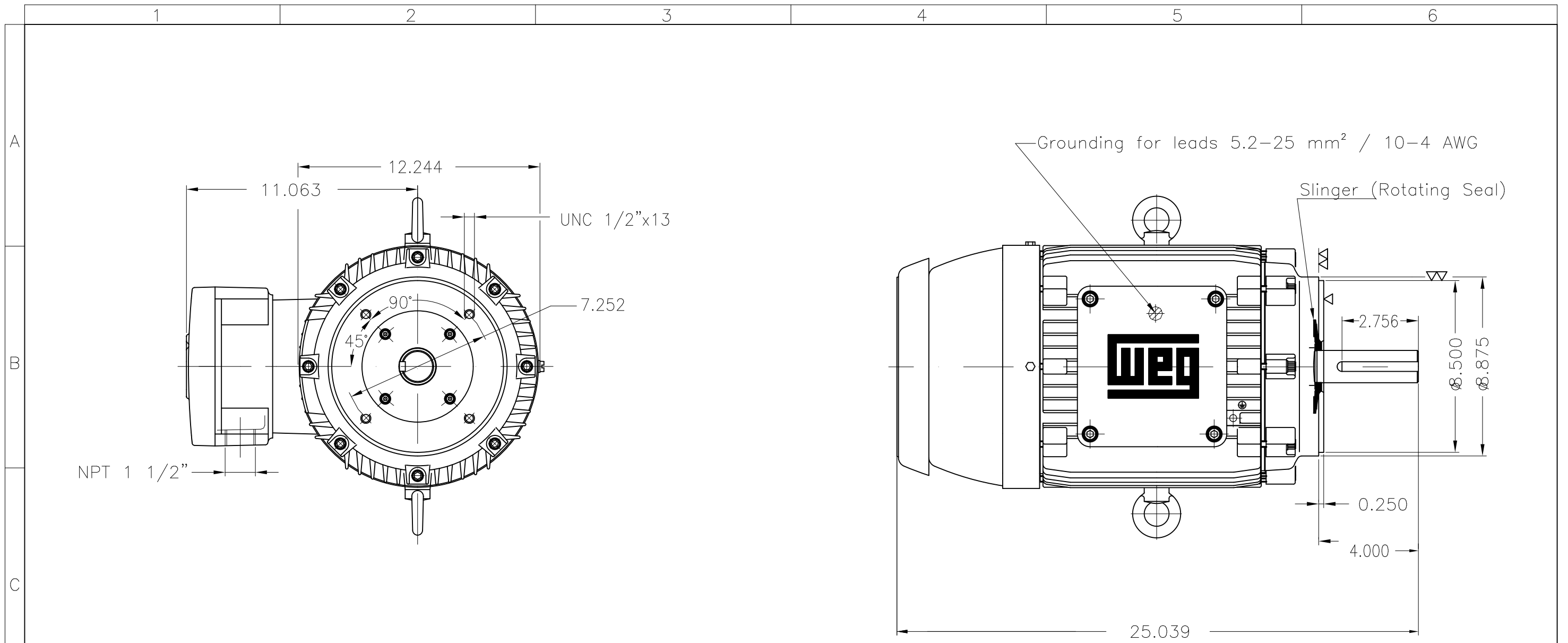

A

B

C

D

E

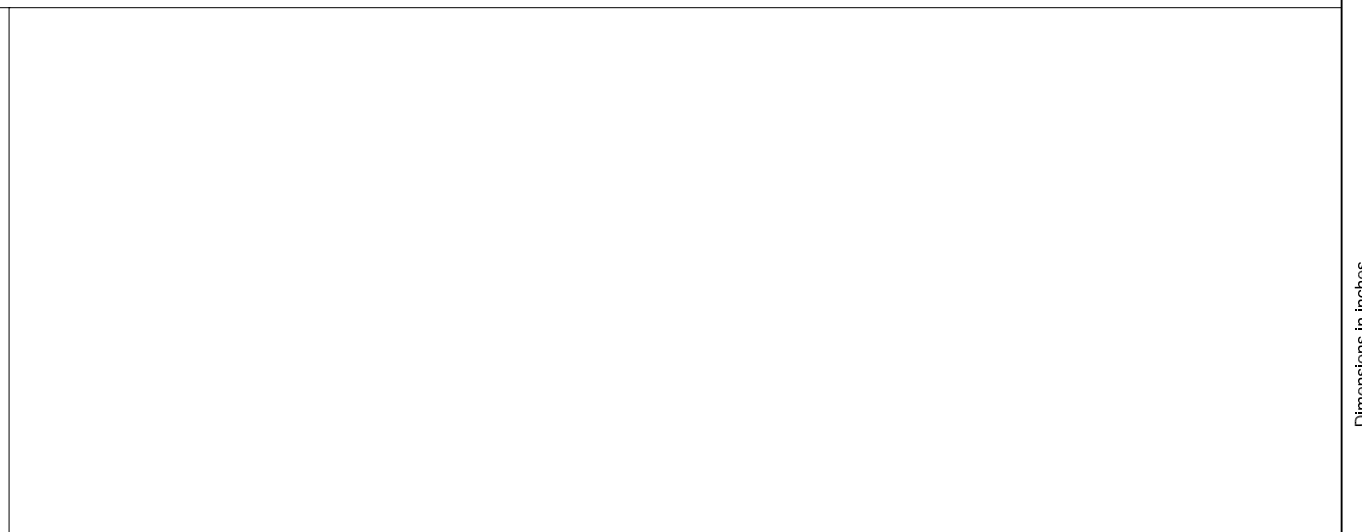
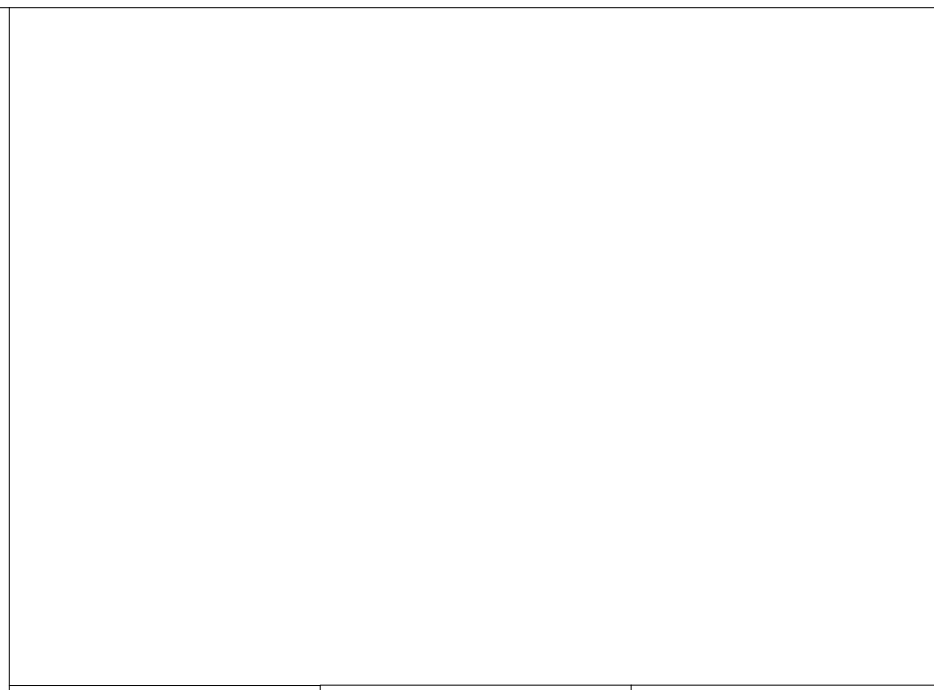

15 HP 04 Poles 60 Hz										A	
ECM	LOC	SUMMARY OF MODIFICATIONS		EXECUTED	CHECKED	RELEASED	DATE	VER			
EXECUTED	PIRWBUSER	THREE PH. MOTOR EXPLOSION PROOF PREM. EFF.						PREVIEW			
CHECKED		FRAME 254TC IP55 TEFC						WDD			
RELEASED											
REL DT.		WMO	Jaragua do Sul	Product Engineering	SHEET	1 / 1					

With grease fitting

Color RAL 5009

Painting plan 202P

Mounting NEMA W-6

Mounting V18

Dimensions in inches XME A3

MADE IN BRAZIL

**W21X NEMA**  
**Premium**

14407394



LISTED

CC029A

*Inverter Duty Motor*  
*Severe Duty*

MODEL 01518XT3ER254TC

PH 3	FR 254TC		
HP(kW) 15.0(11.0)		HZ 60	IP55
V 230/460		A 36.8/18.4	
RPM 1770		NEMA NOM EFF 92.4%	
PF 0.81		SFA 42.3/21.2	DES B
INS CL F $\Delta T$ 80 K		SF 1.15	ENCL TEFC
DUTY CONT.		CODE J	ALT 1000 m.a.s.l.
AMB 40°C	USABLE @208V	40.7 A	SF 1.15 SFA 46.8
AMB 55°C SF1.0			
15HP 11kW 50Hz 380V 22.1A 1455RPM SF1.00 EFF 90.2% (IE2)			

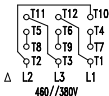
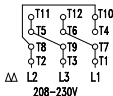

→ 6309-C3 MOBIL POLYREX EM  
→ 6209-C3 13 g 14395 h

340 Lbs



TEMP CODE T3C  
CSA/UL: Class I - Div. 1 - Groups C and D  
CSA: Class II - Div. 1 - Groups F and G  
CSA: Class I - Zone 1 - IIB

EXPLOSION PROOF MOTOR

FOR USE ON VPWM VFD 1000:1VT, 6:1CT, 1.0SF, T3C, AMB 40°C.