

DATA SHEET

Three Phase Induction Motor - Squirrel Cage



Customer :					
Product line	: W40 NEMA Premium Efficiency Three-Phase	Product code :	14494186		
		Catalog # :	02012OT3E286T-W40		
Frame	: 284/6T	Cooling method	: IC01 - ODP		
Insulation class	: F	Mounting	: F-1		
Duty cycle	: Cont.(S1)	Rotation ¹	: Both (CW and CCW)		
Ambient temperature	: -20°C to +40°C	Starting method	: Direct On Line		
Altitude	: 1000 m.a.s.l.	Approx. weight ²	: 384 lb		
Protection degree	: IP23	Moment of inertia (J)	: 6.89 sq.ft.lb		
Design	: B				
Output [HP]	20	15	15	15	15
Poles	6	6	6	6	6
Frequency [Hz]	60	50	50	50	50
Rated voltage [V]	230/460	380	400	415	415
Rated current [A]	48.6/24.3	22.0	21.4	20.9	20.9
L. R. Amperes [A]	311/156	158	161	157	157
LRC [A]	6.4x(Code G)	7.2x(Code H)	7.5x(Code J)	7.5x(Code J)	7.5x(Code J)
No load current [A]	18.8/9.40	9.30	10.0	10.5	10.5
Rated speed [RPM]	1177	980	980	984	984
Slip [%]	1.92	2.00	2.00	1.60	1.60
Rated torque [ft.lb]	89.2	80.4	80.4	80.0	80.0
Locked rotor torque [%]	229	270	310	340	340
Breakdown torque [%]	260	280	320	340	340
Service factor	1.25	1.00	1.00	1.00	1.00
Temperature rise	80 K	80 K	80 K	80 K	80 K
Locked rotor time	27s (cold) 15s (hot)	28s (cold) 16s (hot)	28s (cold) 16s (hot)	28s (cold) 16s (hot)	28s (cold) 16s (hot)
Noise level ²	59.0 dB(A)				
Efficiency (%)	25%	91.5	89.7	89.7	89.7
	50%	91.7	89.9	89.9	89.9
	75%	92.4	90.3	90.3	90.3
	100%	92.4	90.3	90.3	90.3
Power Factor	25%	0.45	0.42	0.39	0.37
	50%	0.71	0.68	0.64	0.62
	75%	0.80	0.79	0.76	0.74
	100%	0.84	0.84	0.82	0.81
Bearing type	: <u>Drive end</u> 6311 Z C3	<u>Non drive end</u> 6211 Z C3	Foundation loads		
Sealing	: Without	Without	Max. traction		
	Bearing Seal	Bearing Seal	Max. compression		
Lubrication interval	: 20000 h	20000 h			
Lubricant amount	: 18 g	11 g			
Lubricant type	: Mobil Polyrex EM				
Notes					
USABLE @208V 53.7A SF 1.15 SFA 61.8A					
This revision replaces and cancel the previous one, which must be eliminated. (1) Looking the motor from the shaft end. (2) Measured at 1m and with tolerance of +3dB(A). (3) Approximate weight subject to changes after manufacturing process. (4) At 100% of full load.			These are average values based on tests with sinusoidal power supply, subject to the tolerances stipulated in NEMA MG-1.		
Rev.	Changes Summary		Performed	Checked	Date
Performed by					
Checked by				Page	Revision
Date	14/04/2022			1 / 21	

TORQUE AND CURRENT VS SPEED CURVE

Three Phase Induction Motor - Squirrel Cage



Customer :

Product line : W40 NEMA Premium Efficiency
Three-Phase

Product code : 14494186

Catalog # : 020120T3E286T-W40

TORQUE AND CURRENT VS SPEED CURVE

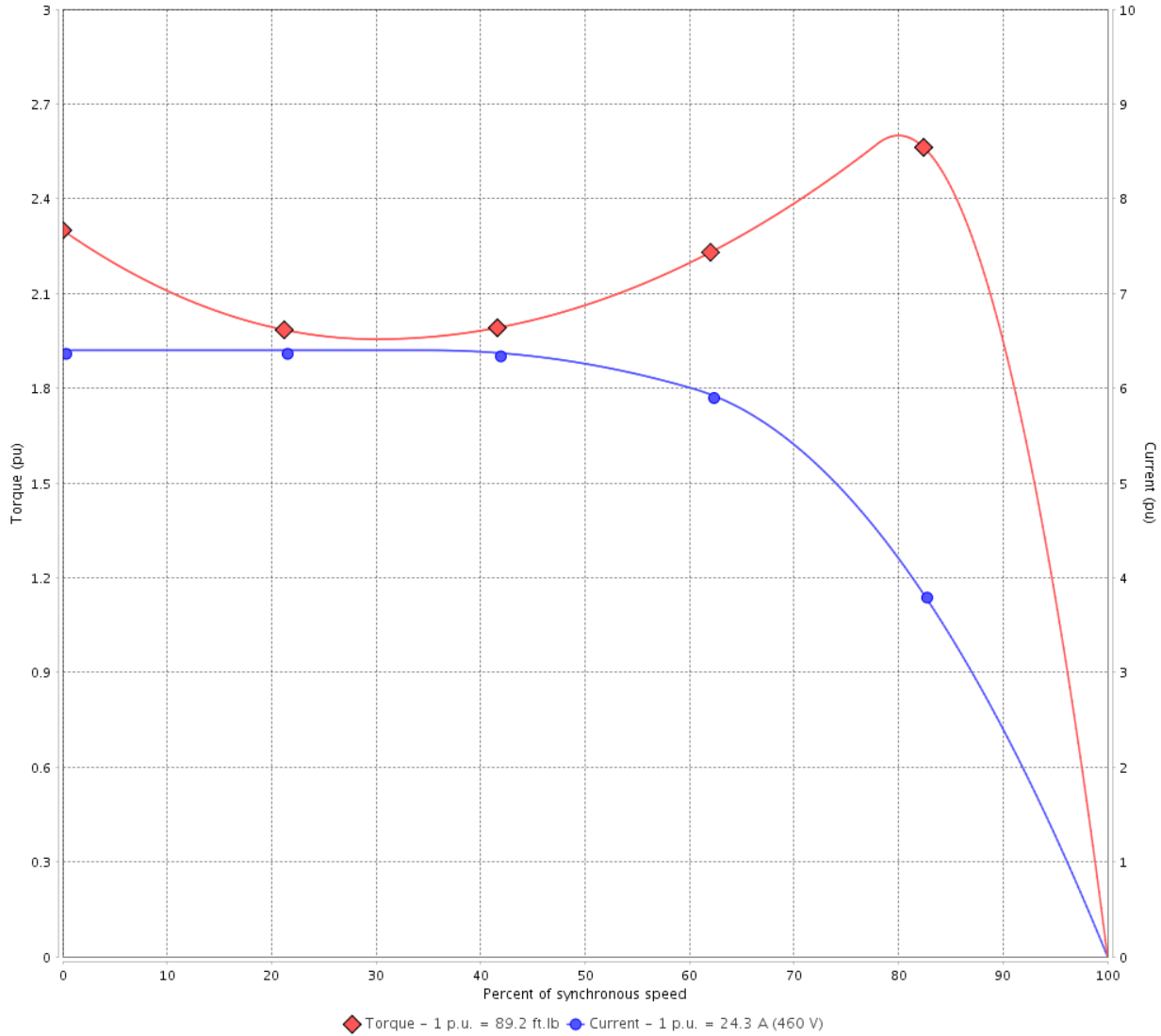

Performance : 230/460 V 60 Hz 6P

Rated current	: 48.6/24.3 A	Moment of inertia (J)	: 6.89 sq.ft.lb
LRC	: 6.4	Duty cycle	: Cont.(S1)
Rated torque	: 89.2 ft.lb	Insulation class	: F
Locked rotor torque	: 229 %	Service factor	: 1.25
Breakdown torque	: 260 %	Temperature rise	: 80 K
Rated speed	: 1177 rpm	Design	: B

Locked rotor time : 27s (cold) 15s (hot)

Rev.	Changes Summary	Performed	Checked	Date
Performed by			Page 2 / 21	Revision
Checked by				
Date	14/04/2022			

TORQUE AND CURRENT VS SPEED CURVE



Three Phase Induction Motor - Squirrel Cage

Customer :

Product line : W40 NEMA Premium Efficiency
Three-Phase

Product code : 14494186

Catalog # : 02012OT3E286T-W40

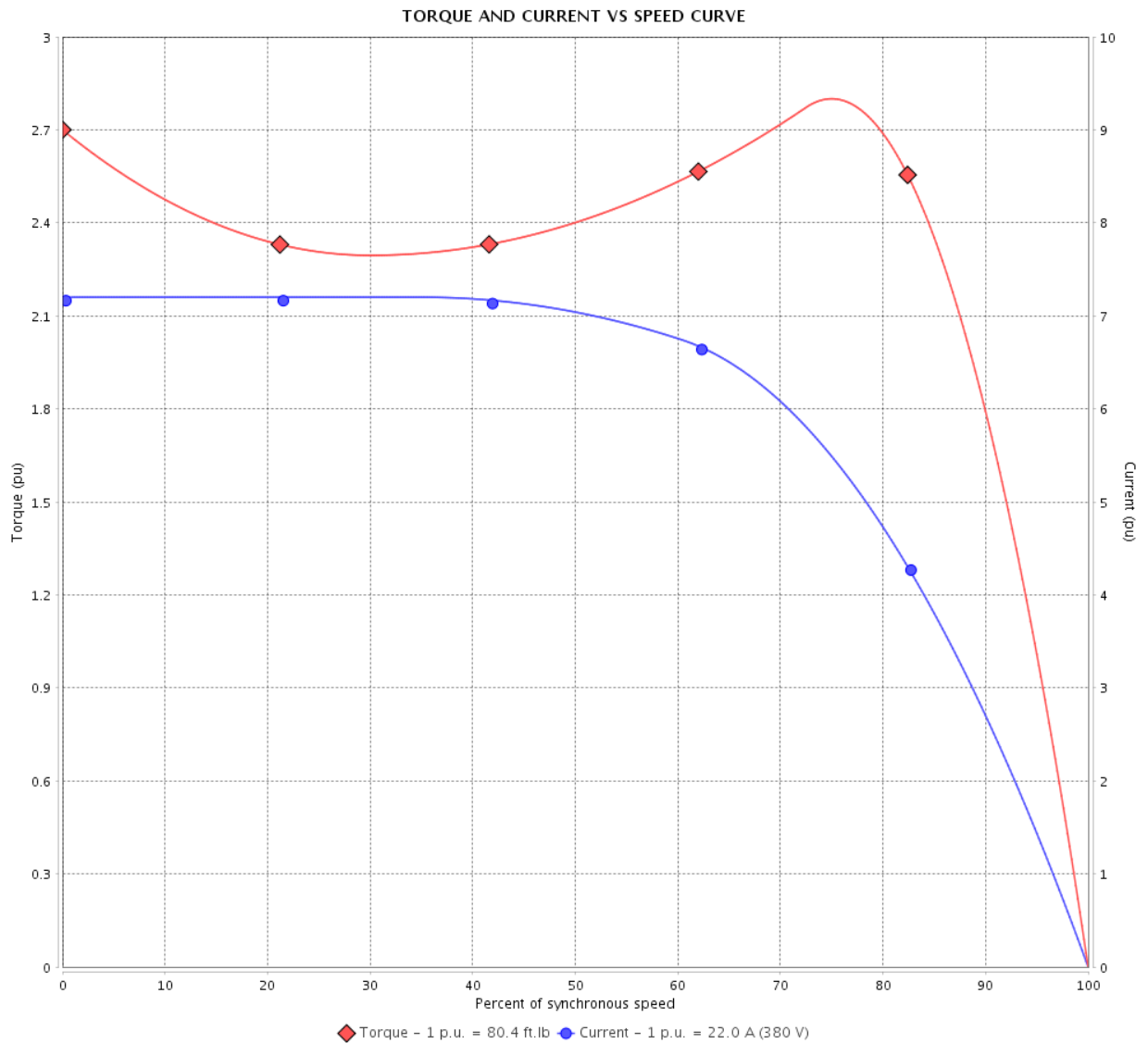

Performance : 380 V 50 Hz 6P IE3

Rated current	: 22.0 A	Moment of inertia (J)	: 6.89 sq.ft.lb
LRC	: 7.2	Duty cycle	: Cont.(S1)
Rated torque	: 80.4 ft.lb	Insulation class	: F
Locked rotor torque	: 270 %	Service factor	: 1.00
Breakdown torque	: 280 %	Temperature rise	: 80 K
Rated speed	: 980 rpm	Design	: B

Locked rotor time : 28s (cold) 16s (hot)

Rev.	Changes Summary	Performed	Checked	Date
Performed by			Page 3 / 21	Revision
Checked by				
Date	14/04/2022			

TORQUE AND CURRENT VS SPEED CURVE

Three Phase Induction Motor - Squirrel Cage



Customer :

Product line : W40 NEMA Premium Efficiency
Three-Phase

Product code : 14494186

Catalog # : 020120T3E286T-W40

TORQUE AND CURRENT VS SPEED CURVE

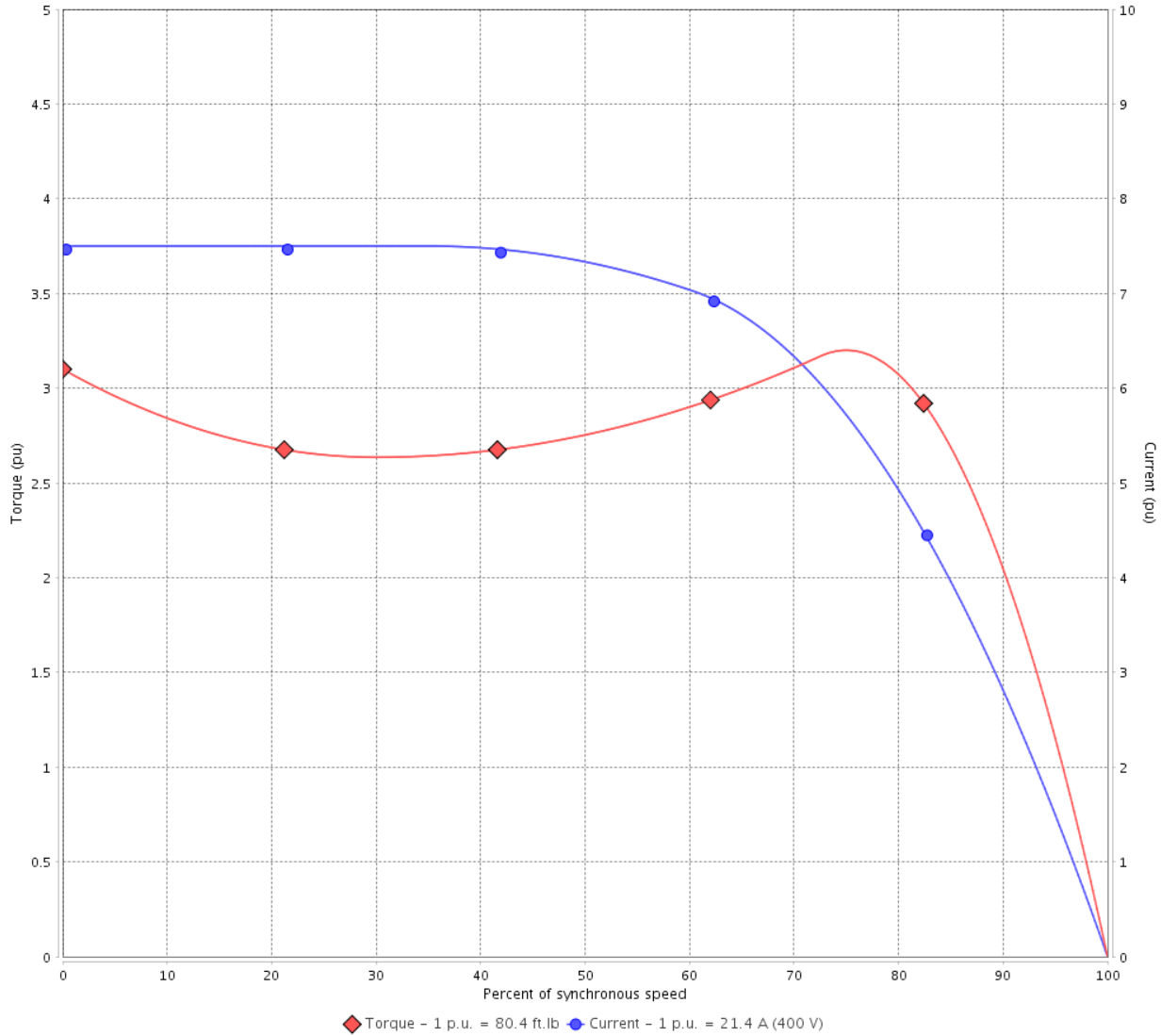

Performance : 400 V 50 Hz 6P IE3

Rated current	: 21.4 A	Moment of inertia (J)	: 6.89 sq.ft.lb
LRC	: 7.5	Duty cycle	: Cont.(S1)
Rated torque	: 80.4 ft.lb	Insulation class	: F
Locked rotor torque	: 310 %	Service factor	: 1.00
Breakdown torque	: 320 %	Temperature rise	: 80 K
Rated speed	: 980 rpm	Design	: B

Locked rotor time : 28s (cold) 16s (hot)

Rev.	Changes Summary	Performed	Checked	Date
Performed by			Page 4 / 21	Revision
Checked by				
Date	14/04/2022			

TORQUE AND CURRENT VS SPEED CURVE



Three Phase Induction Motor - Squirrel Cage

Customer :

Product line : W40 NEMA Premium Efficiency
Three-Phase

Product code : 14494186

Catalog # : 02012OT3E286T-W40

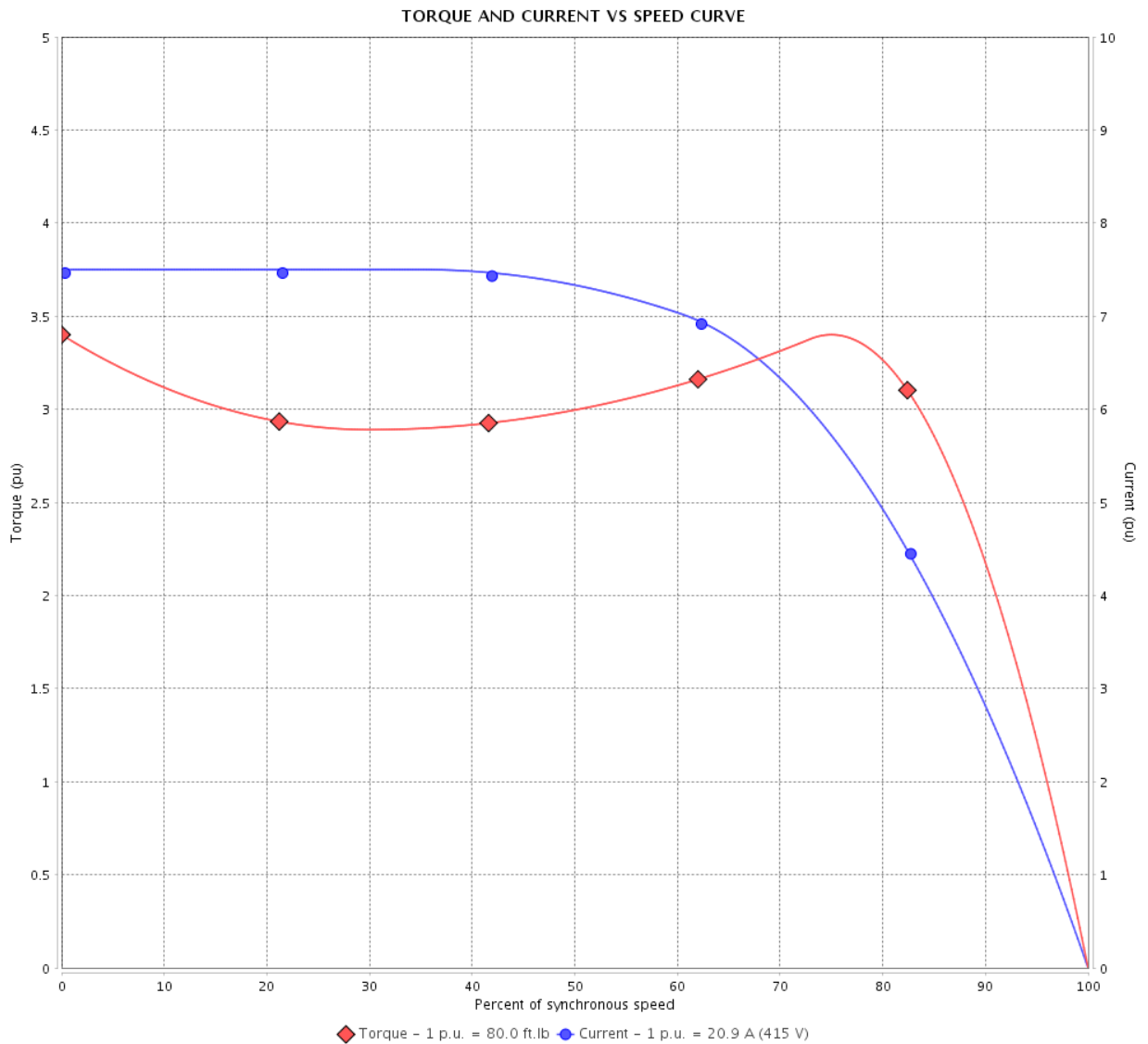

Performance : 415 V 50 Hz 6P IE3

Rated current	: 20.9 A	Moment of inertia (J)	: 6.89 sq.ft.lb
LRC	: 7.5	Duty cycle	: Cont.(S1)
Rated torque	: 80.0 ft.lb	Insulation class	: F
Locked rotor torque	: 340 %	Service factor	: 1.00
Breakdown torque	: 340 %	Temperature rise	: 80 K
Rated speed	: 984 rpm	Design	: B

Locked rotor time : 28s (cold) 16s (hot)

Rev.	Changes Summary	Performed	Checked	Date
Performed by			Page 5 / 21	Revision
Checked by				
Date	14/04/2022			

LOAD PERFORMANCE CURVE

Three Phase Induction Motor - Squirrel Cage



Customer : _____

Product line : W40 NEMA Premium Efficiency
Three-Phase

Product code : 14494186

Catalog # : 02012OT3E286T-W40

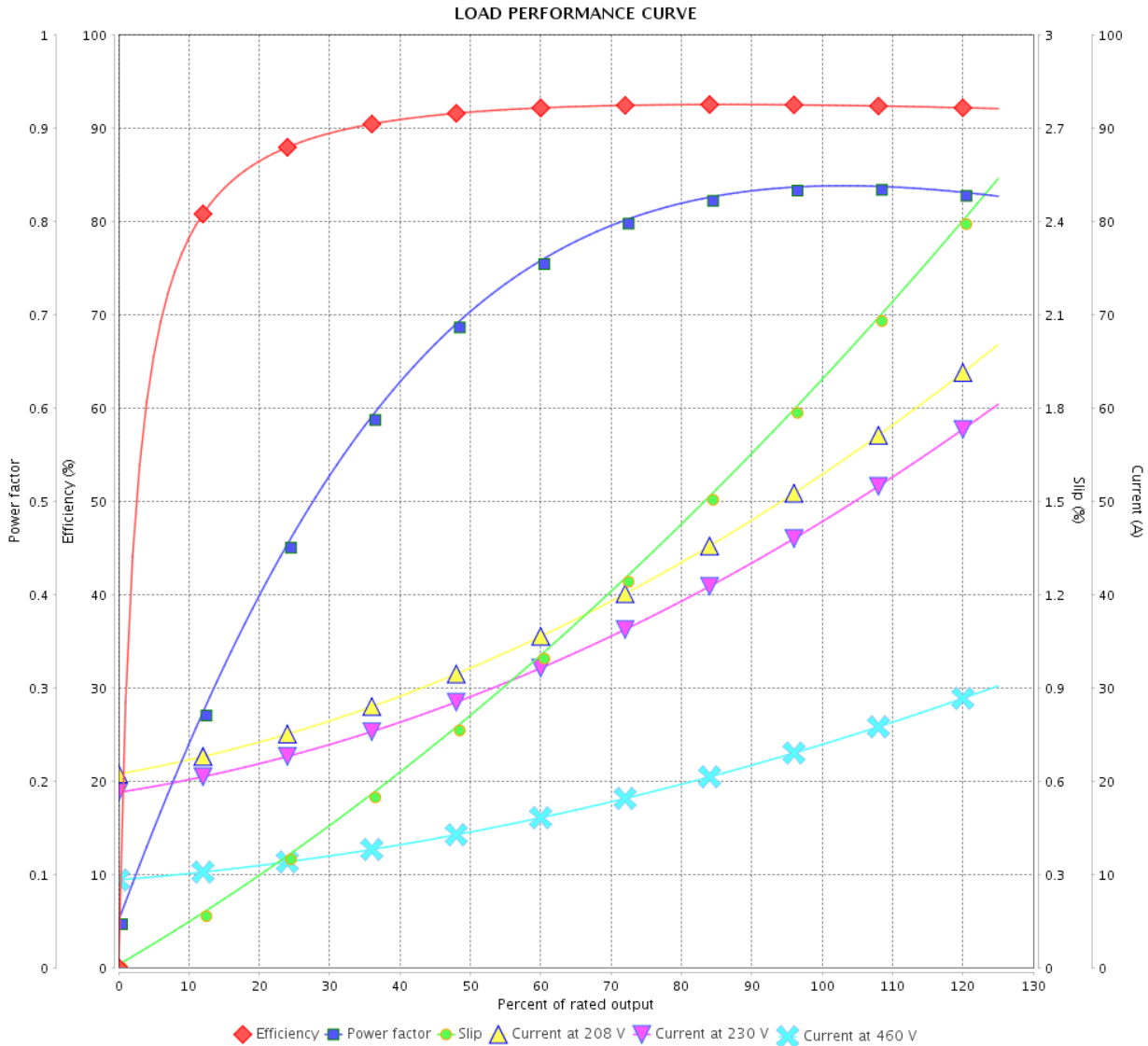

Performance : 230/460 V 60 Hz 6P

Rated current : 48.6/24.3 A
 LRC : 6.4
 Rated torque : 89.2 ft.lb
 Locked rotor torque : 229 %
 Breakdown torque : 260 %
 Rated speed : 1177 rpm

Moment of inertia (J) : 6.89 sq.ft.lb
 Duty cycle : Cont.(S1)
 Insulation class : F
 Service factor : 1.25
 Temperature rise : 80 K
 Design : B

Rev.	Changes Summary	Performed	Checked	Date
Performed by			Page	Revision
Checked by				
Date				

LOAD PERFORMANCE CURVE

Three Phase Induction Motor - Squirrel Cage



Customer : _____

Product line : W40 NEMA Premium Efficiency
Three-Phase

Product code : 14494186

Catalog # : 02012OT3E286T-W40

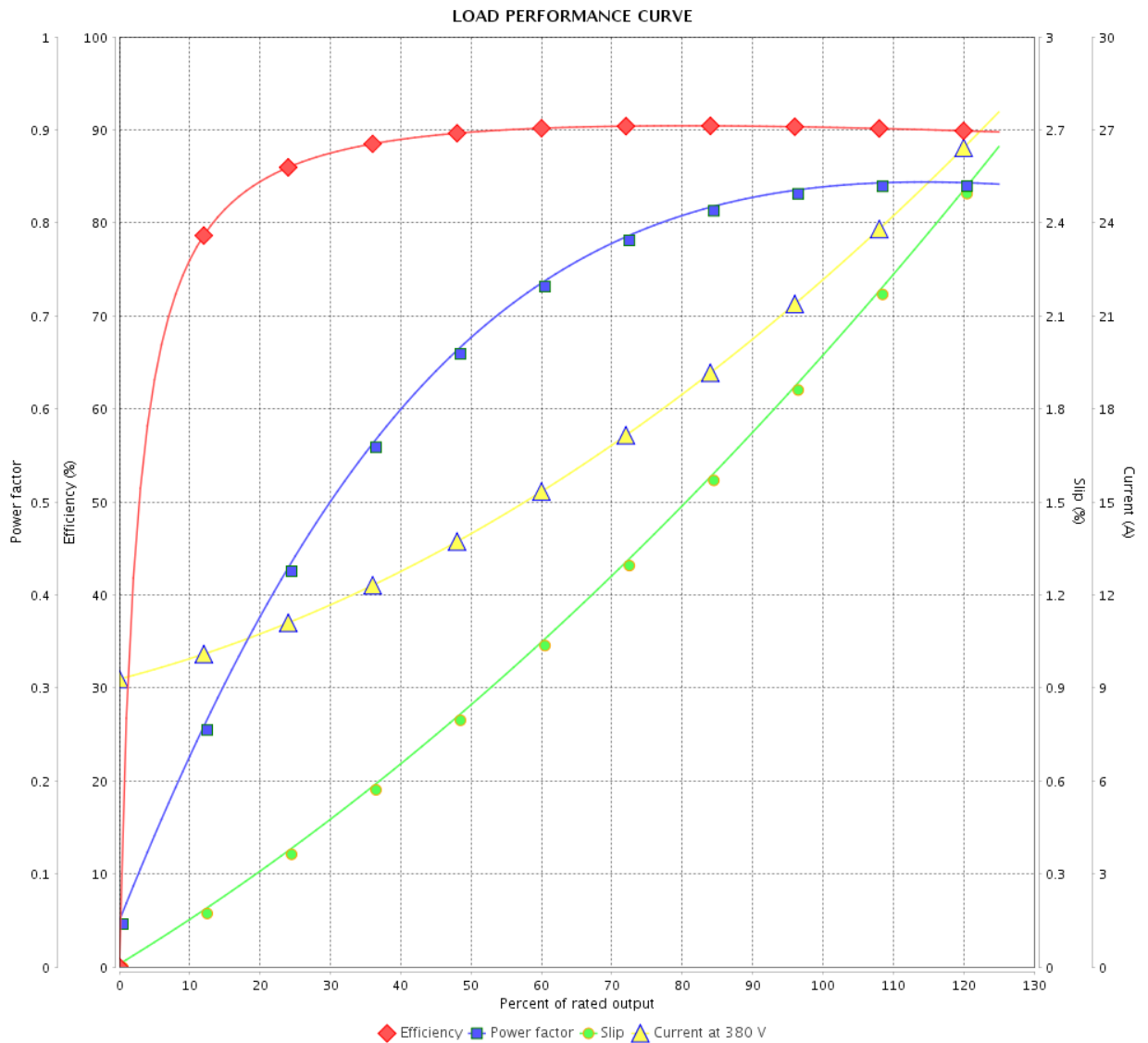

Performance : 380 V 50 Hz 6P IE3

Rated current : 22.0 A
 LRC : 7.2
 Rated torque : 80.4 ft.lb
 Locked rotor torque : 270 %
 Breakdown torque : 280 %
 Rated speed : 980 rpm

Moment of inertia (J) : 6.89 sq.ft.lb
 Duty cycle : Cont.(S1)
 Insulation class : F
 Service factor : 1.00
 Temperature rise : 80 K
 Design : B

Rev.	Changes Summary	Performed	Checked	Date
Performed by		Page		Revision
Checked by		7 / 21		
Date		14/04/2022		

LOAD PERFORMANCE CURVE

Three Phase Induction Motor - Squirrel Cage



Customer :

Product line : W40 NEMA Premium Efficiency Three-Phase

Product code : 14494186

Catalog # : 020120T3E286T-W40

LOAD PERFORMANCE CURVE

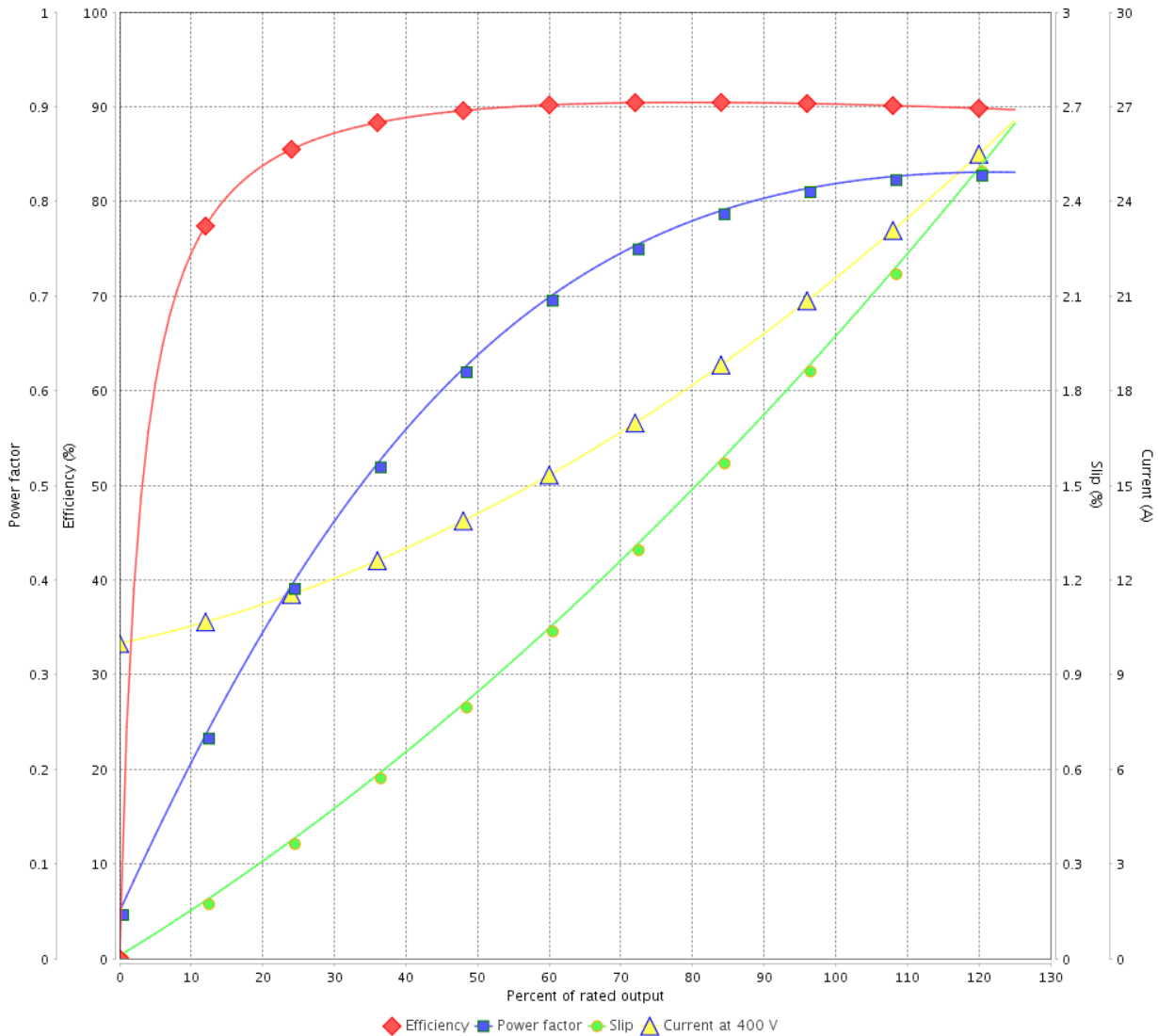

Performance : 400 V 50 Hz 6P IE3

Rated current	: 21.4 A	Moment of inertia (J)	: 6.89 sq.ft.lb
LRC	: 7.5	Duty cycle	: Cont.(S1)
Rated torque	: 80.4 ft.lb	Insulation class	: F
Locked rotor torque	: 310 %	Service factor	: 1.00
Breakdown torque	: 320 %	Temperature rise	: 80 K
Rated speed	: 980 rpm	Design	: B

Rev.	Changes Summary	Performed	Checked	Date
Performed by			Page	Revision
Checked by			8 / 21	
Date	14/04/2022			

LOAD PERFORMANCE CURVE

Three Phase Induction Motor - Squirrel Cage



Customer : _____

Product line : W40 NEMA Premium Efficiency
Three-Phase

Product code : 14494186

Catalog # : 02012OT3E286T-W40

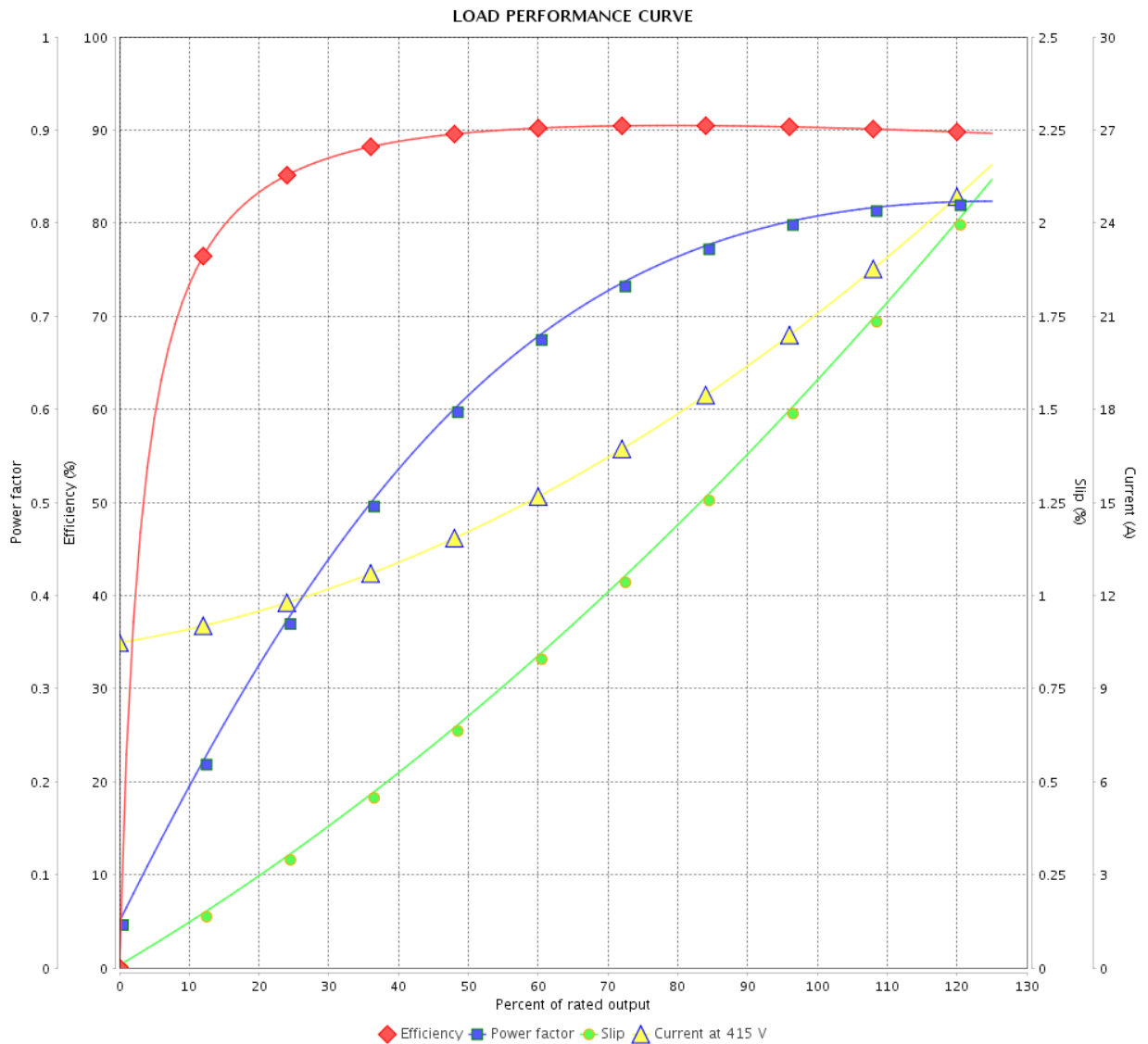

Performance : 415 V 50 Hz 6P IE3

Rated current : 20.9 A
 LRC : 7.5
 Rated torque : 80.0 ft.lb
 Locked rotor torque : 340 %
 Breakdown torque : 340 %
 Rated speed : 984 rpm

Moment of inertia (J) : 6.89 sq.ft.lb
 Duty cycle : Cont.(S1)
 Insulation class : F
 Service factor : 1.00
 Temperature rise : 80 K
 Design : B

Rev.	Changes Summary	Performed	Checked	Date
Performed by		Page		Revision
Checked by		9 / 21		
Date		14/04/2022		

THERMAL LIMIT CURVE

Three Phase Induction Motor - Squirrel Cage



Customer :

Product line : W40 NEMA Premium Efficiency
Three-Phase

Product code : 14494186

Catalog # : 02012OT3E286T-W40

Performance : 230/460 V 60 Hz 6P

Rated current : 48.6/24.3 A
LRC : 6.4
Rated torque : 89.2 ft.lb
Locked rotor torque : 229 %
Breakdown torque : 260 %
Rated speed : 1177 rpm

Moment of inertia (J) : 6.89 sq.ft.lb
Duty cycle : Cont.(S1)
Insulation class : F
Service factor : 1.25
Temperature rise : 80 K
Design : B

Heating constant

Cooling constant

Rev.	Changes Summary	Performed	Checked	Date
Performed by				
Checked by			Page	Revision
Date	14/04/2022		10 / 21	

THERMAL LIMIT CURVE

Three Phase Induction Motor - Squirrel Cage



Customer : _____

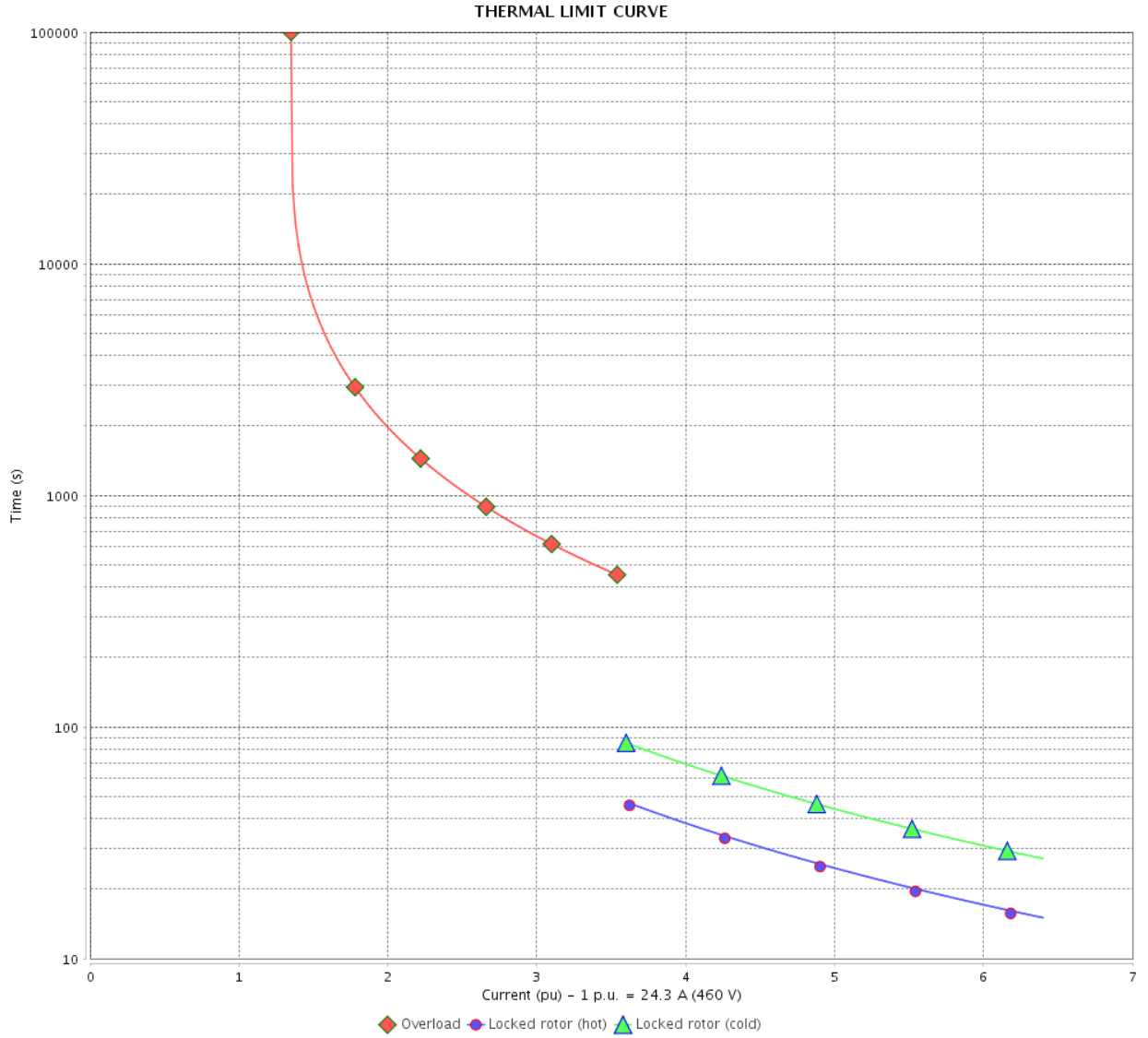

Rev.	Changes Summary	Performed	Checked	Date
Performed by		Page		Revision
Checked by		11 / 21		
Date		14/04/2022		

THERMAL LIMIT CURVE



Three Phase Induction Motor - Squirrel Cage

Customer :

Product line : W40 NEMA Premium Efficiency
Three-Phase

Product code : 14494186

Catalog # : 02012OT3E286T-W40

Performance : 380 V 50 Hz 6P IE3

Rated current : 22.0 A
LRC : 7.2
Rated torque : 80.4 ft.lb
Locked rotor torque : 270 %
Breakdown torque : 280 %
Rated speed : 980 rpm

Moment of inertia (J) : 6.89 sq.ft.lb
Duty cycle : Cont.(S1)
Insulation class : F
Service factor : 1.00
Temperature rise : 80 K
Design : B

Heating constant

Cooling constant

Rev.	Changes Summary	Performed	Checked	Date
Performed by				
Checked by			Page	Revision
Date	14/04/2022		12 / 21	

THERMAL LIMIT CURVE

Three Phase Induction Motor - Squirrel Cage



Customer : _____

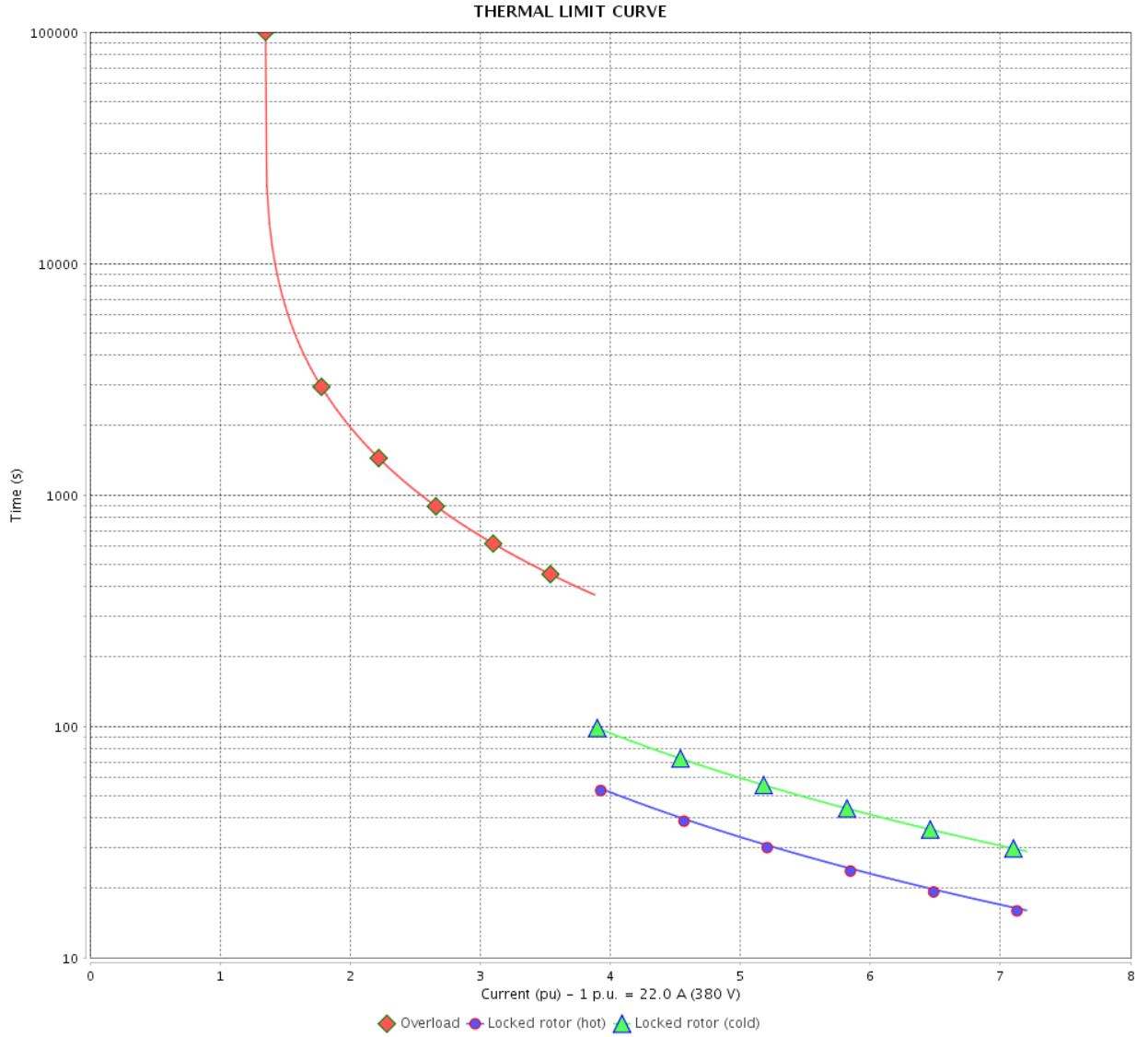

Rev.	Changes Summary	Performed	Checked	Date
Performed by				
Checked by				
Date				
			Page	Revision
			13 / 21	

THERMAL LIMIT CURVE



Three Phase Induction Motor - Squirrel Cage

Customer :

Product line : W40 NEMA Premium Efficiency
Three-Phase

Product code : 14494186

Catalog # : 02012OT3E286T-W40

Performance : 400 V 50 Hz 6P IE3

Rated current : 21.4 A
LRC : 7.5
Rated torque : 80.4 ft.lb
Locked rotor torque : 310 %
Breakdown torque : 320 %
Rated speed : 980 rpm

Moment of inertia (J) : 6.89 sq.ft.lb
Duty cycle : Cont.(S1)
Insulation class : F
Service factor : 1.00
Temperature rise : 80 K
Design : B

Heating constant

Cooling constant

Rev.	Changes Summary	Performed	Checked	Date
Performed by				
Checked by			Page	Revision
Date	14/04/2022		14 / 21	

THERMAL LIMIT CURVE

Three Phase Induction Motor - Squirrel Cage



Customer : _____

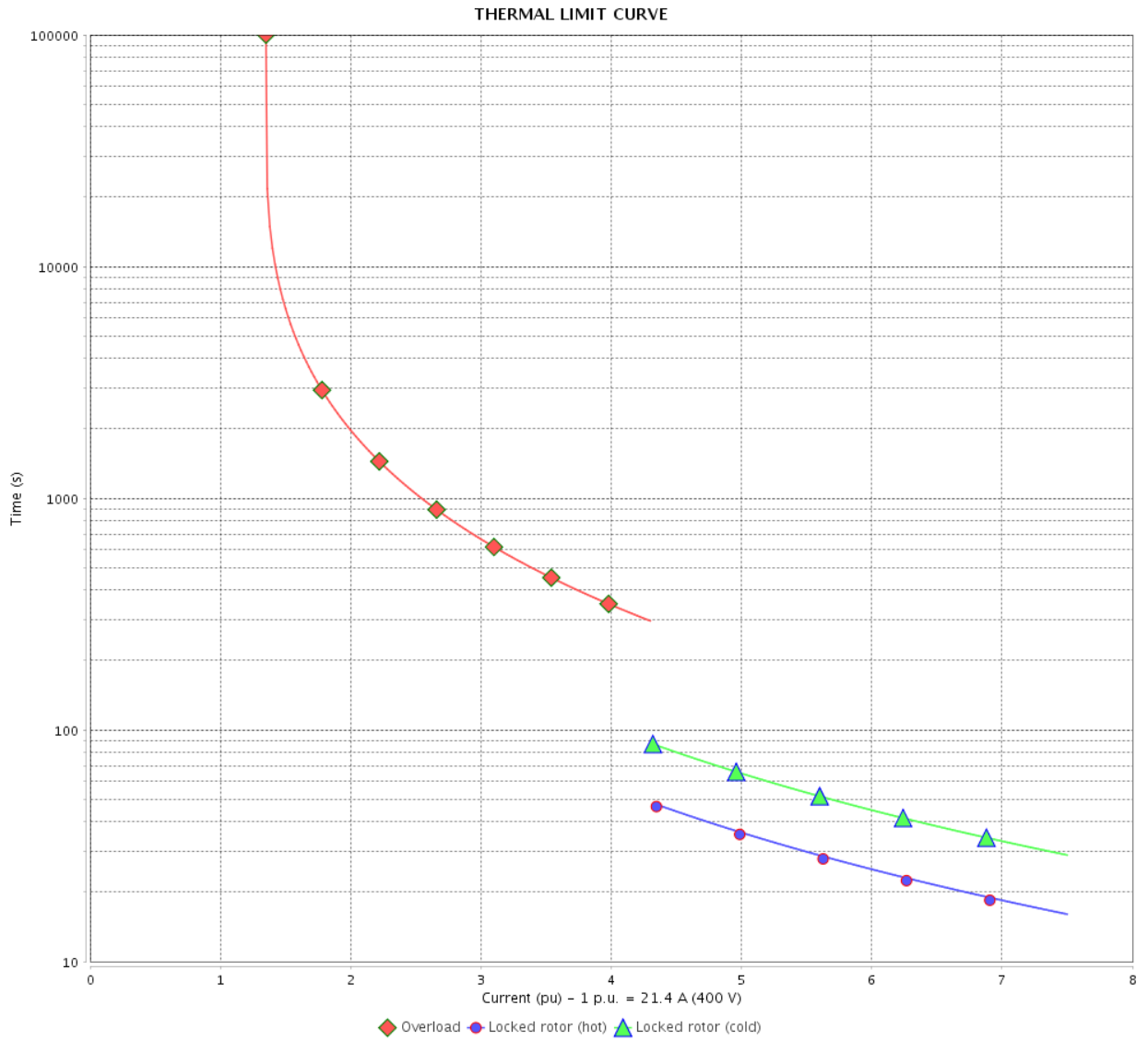

Rev.	Changes Summary	Performed	Checked	Date
Performed by				
Checked by				
Date				
			Page	Revision
			15 / 21	

THERMAL LIMIT CURVE



Three Phase Induction Motor - Squirrel Cage

Customer :

Product line : W40 NEMA Premium Efficiency
Three-Phase

Product code : 14494186

Catalog # : 02012OT3E286T-W40

Performance : 415 V 50 Hz 6P IE3

Rated current : 20.9 A
LRC : 7.5
Rated torque : 80.0 ft.lb
Locked rotor torque : 340 %
Breakdown torque : 340 %
Rated speed : 984 rpm

Moment of inertia (J) : 6.89 sq.ft.lb
Duty cycle : Cont.(S1)
Insulation class : F
Service factor : 1.00
Temperature rise : 80 K
Design : B

Heating constant

Cooling constant

Rev.	Changes Summary	Performed	Checked	Date
Performed by				
Checked by			Page	Revision
Date	14/04/2022		16 / 21	

THERMAL LIMIT CURVE

Three Phase Induction Motor - Squirrel Cage



Customer : _____

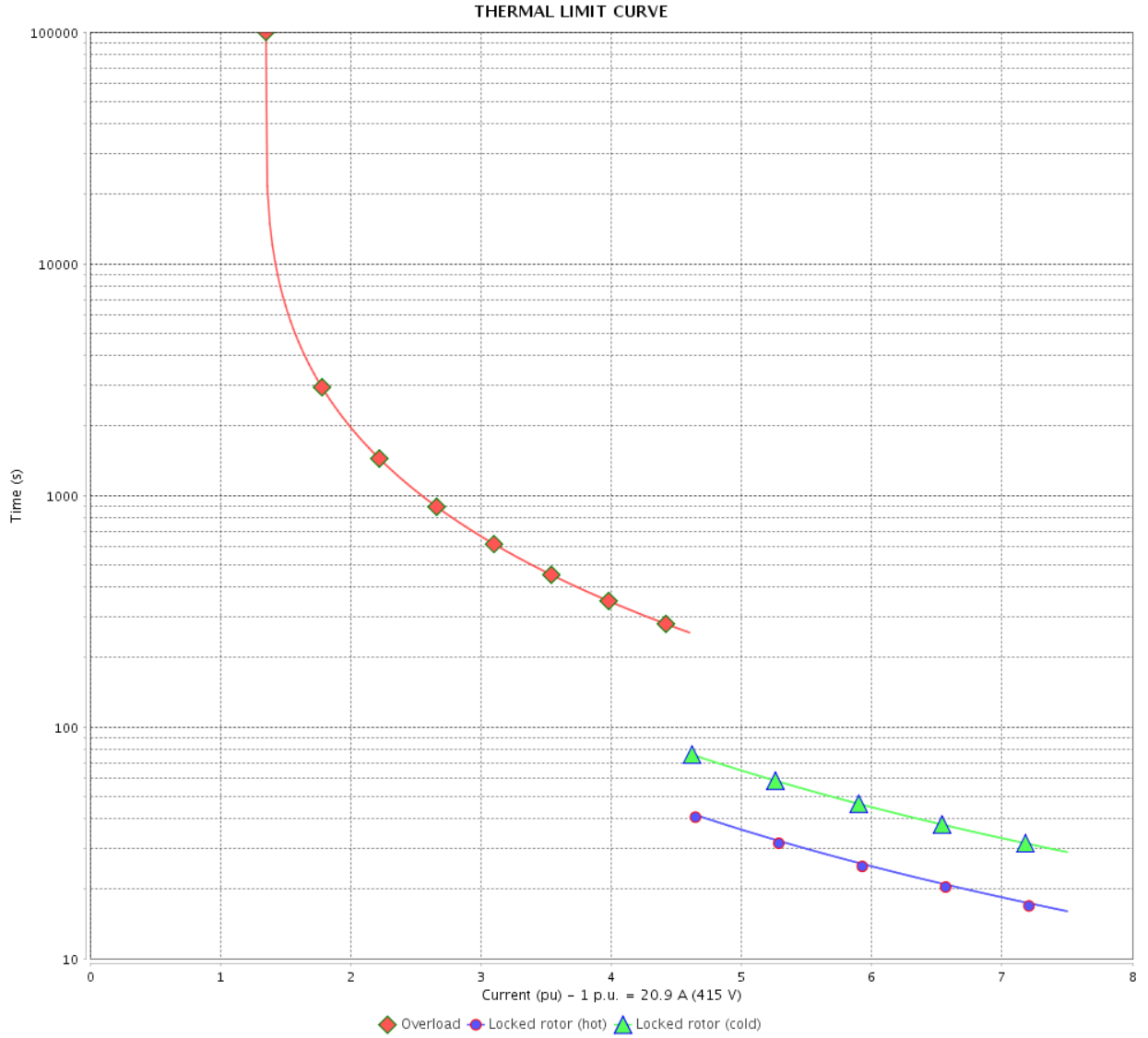

Rev.	Changes Summary	Performed	Checked	Date
Performed by		Page 17 / 21		Revision
Checked by				
Date				

VFD OPERATION CURVE

Three Phase Induction Motor - Squirrel Cage



Customer :

Product line : W40 NEMA Premium Efficiency Three-Phase

Product code : 14494186

Catalog # : 02012OT3E286T-W40

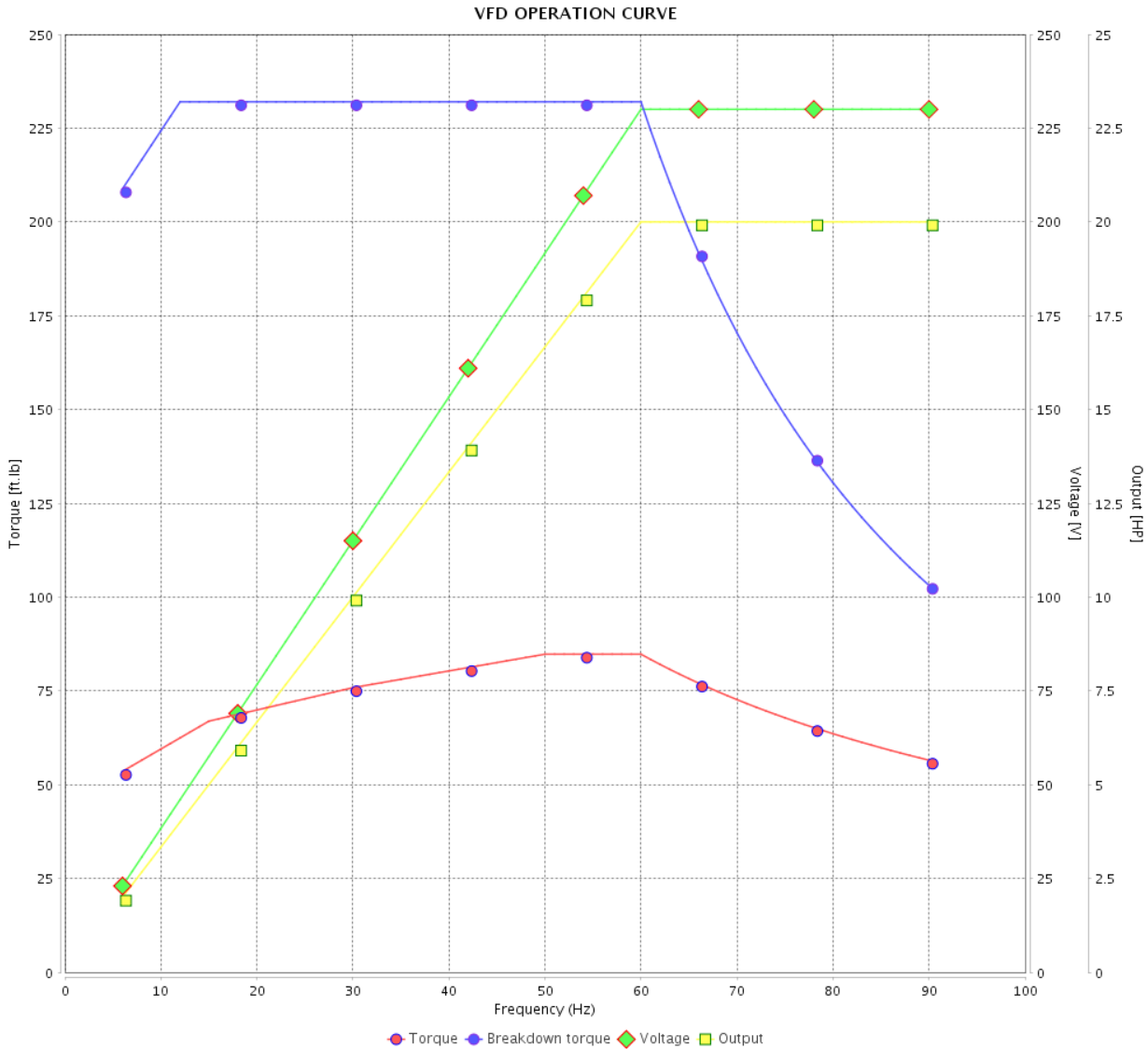

Performance : 230/460 V 60 Hz 6P

Rated current : 48.6/24.3 A
 LRC : 6.4
 Rated torque : 89.2 ft.lb
 Locked rotor torque : 229 %
 Breakdown torque : 260 %
 Rated speed : 1177 rpm

Moment of inertia (J) : 6.89 sq.ft.lb
 Duty cycle : Cont.(S1)
 Insulation class : F
 Service factor : 1.25
 Temperature rise : 80 K
 Design : B

Rev.	Changes Summary	Performed	Checked	Date
Performed by			Page	Revision
Checked by				
Date				

VFD OPERATION CURVE

Three Phase Induction Motor - Squirrel Cage



Customer :

Product line : W40 NEMA Premium Efficiency
Three-Phase

Product code : 14494186

Catalog # : 02012OT3E286T-W40

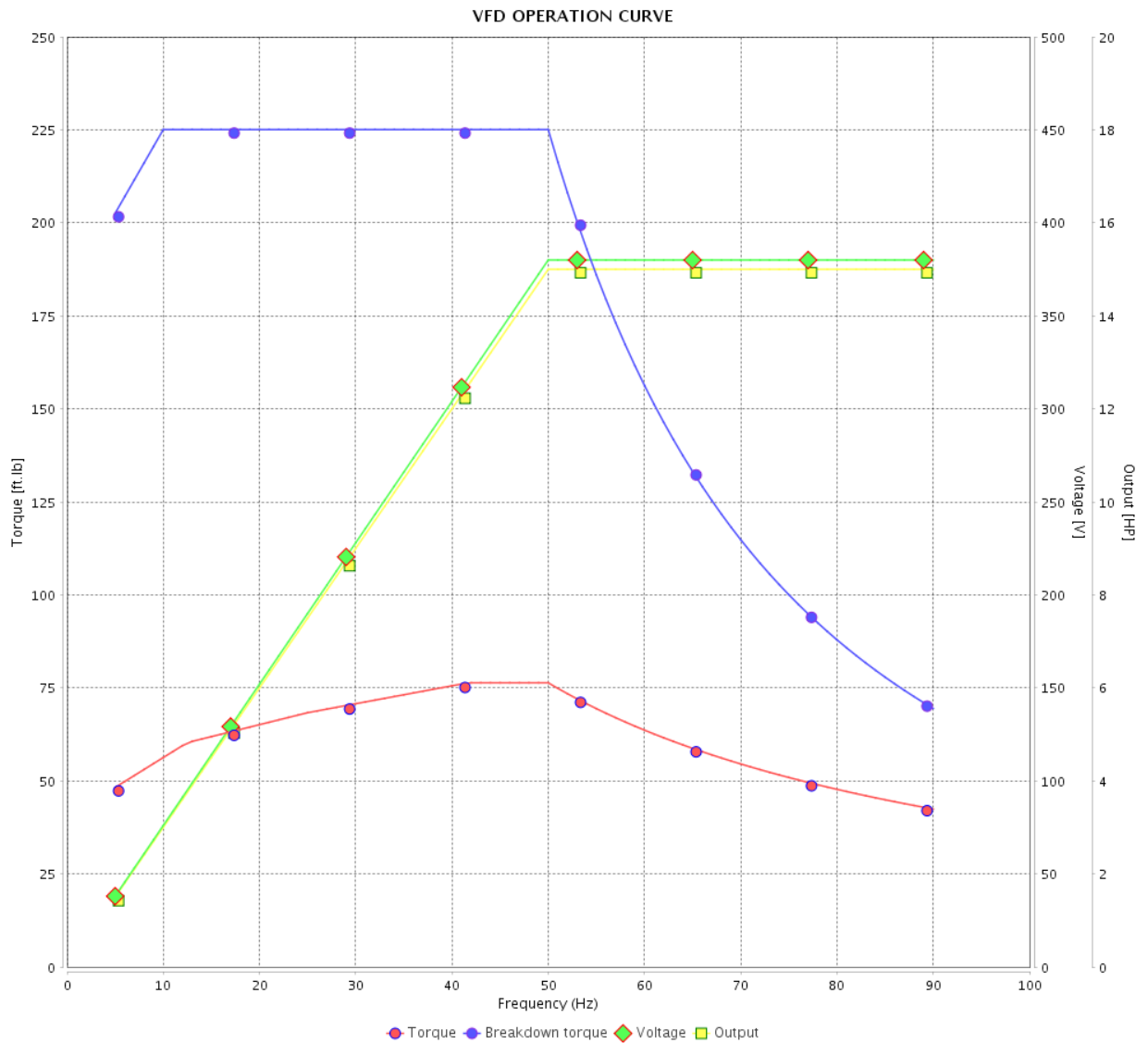

Performance : 380 V 50 Hz 6P IE3

Rated current : 22.0 A
 LRC : 7.2
 Rated torque : 80.4 ft.lb
 Locked rotor torque : 270 %
 Breakdown torque : 280 %
 Rated speed : 980 rpm

Moment of inertia (J) : 6.89 sq.ft.lb
 Duty cycle : Cont.(S1)
 Insulation class : F
 Service factor : 1.00
 Temperature rise : 80 K
 Design : B

Rev.	Changes Summary	Performed	Checked	Date
Performed by			Page 19 / 21	Revision
Checked by				
Date	14/04/2022			

VFD OPERATION CURVE

Three Phase Induction Motor - Squirrel Cage



Customer :

Product line : W40 NEMA Premium Efficiency Three-Phase

Product code : 14494186

Catalog # : 02012OT3E286T-W40

VFD OPERATION CURVE

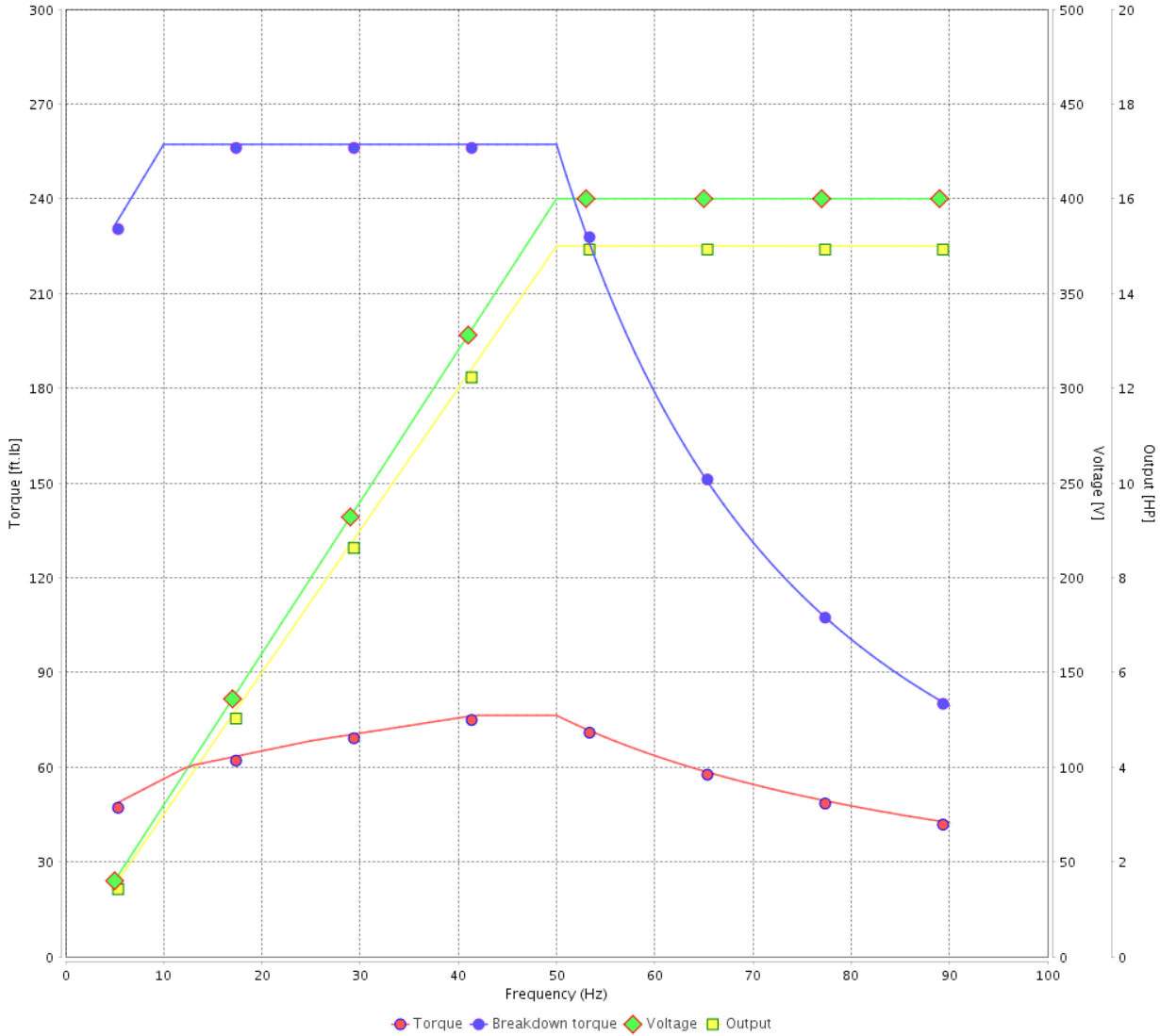

Performance : 400 V 50 Hz 6P IE3

Rated current : 21.4 A
 LRC : 7.5
 Rated torque : 80.4 ft.lb
 Locked rotor torque : 310 %
 Breakdown torque : 320 %
 Rated speed : 980 rpm

Moment of inertia (J) : 6.89 sq.ft.lb
 Duty cycle : Cont.(S1)
 Insulation class : F
 Service factor : 1.00
 Temperature rise : 80 K
 Design : B

Rev.	Changes Summary	Performed	Checked	Date
Performed by			Page 20 / 21	Revision
Checked by				
Date	14/04/2022			

VFD OPERATION CURVE

Three Phase Induction Motor - Squirrel Cage



Customer :

Product line : W40 NEMA Premium Efficiency
Three-Phase

Product code : 14494186

Catalog # : 02012OT3E286T-W40

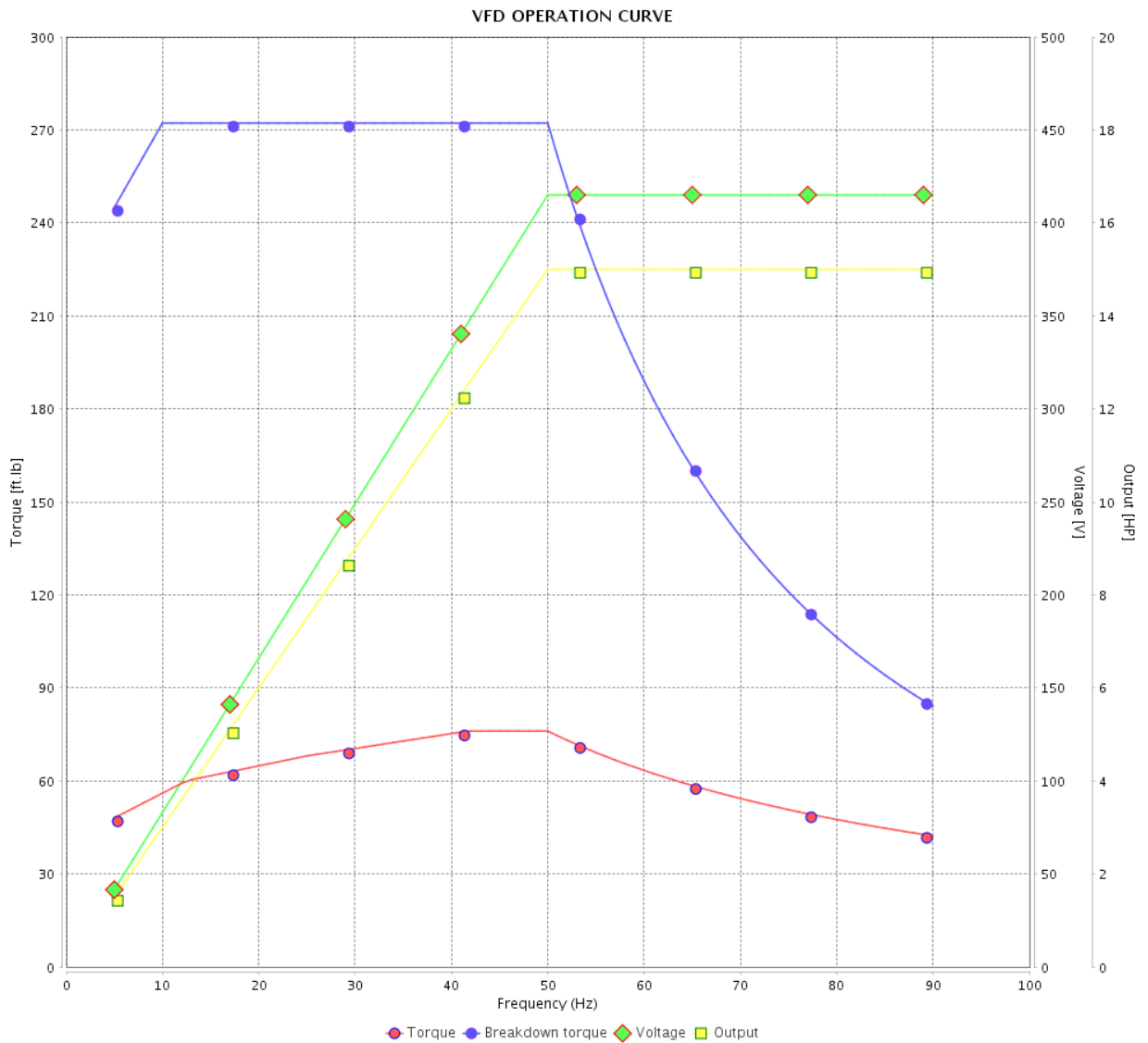

Performance : 415 V 50 Hz 6P IE3

Rated current : 20.9 A
LRC : 7.5
Rated torque : 80.0 ft.lb
Locked rotor torque : 340 %
Breakdown torque : 340 %
Rated speed : 984 rpm

Moment of inertia (J) : 6.89 sq.ft.lb
Duty cycle : Cont.(S1)
Insulation class : F
Service factor : 1.00
Temperature rise : 80 K
Design : B

Rev.	Changes Summary	Performed	Checked	Date
Performed by		Page		Revision
Checked by		21 / 21		
Date	14/04/2022			

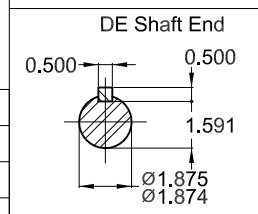
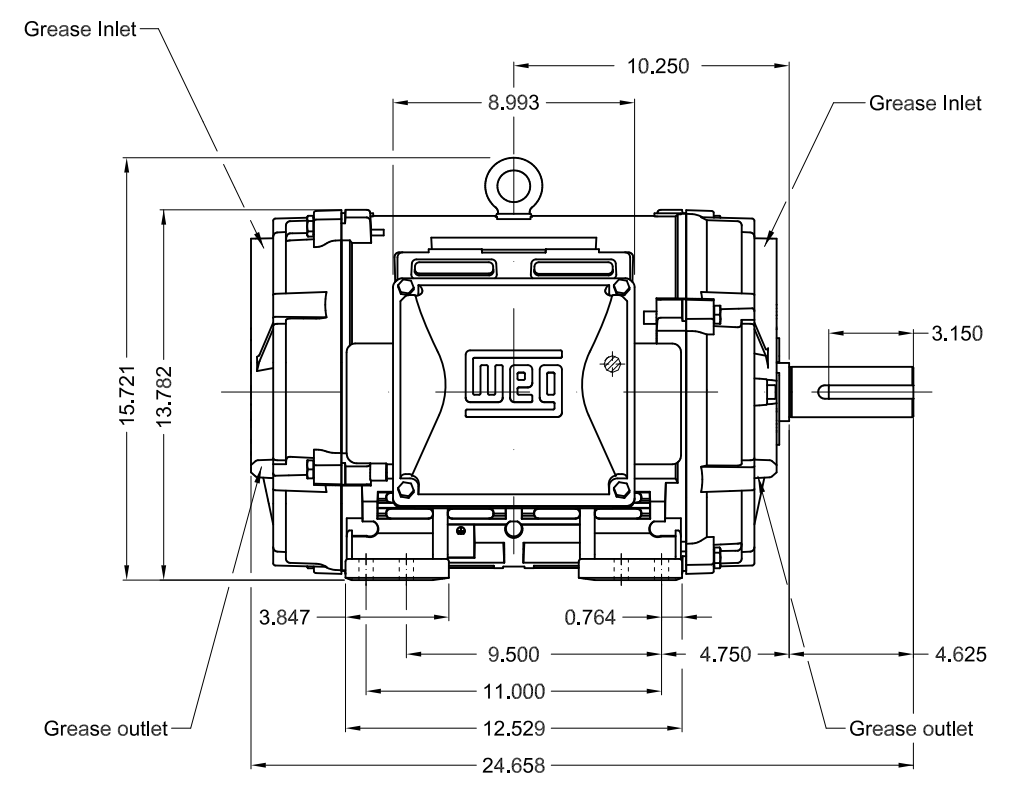
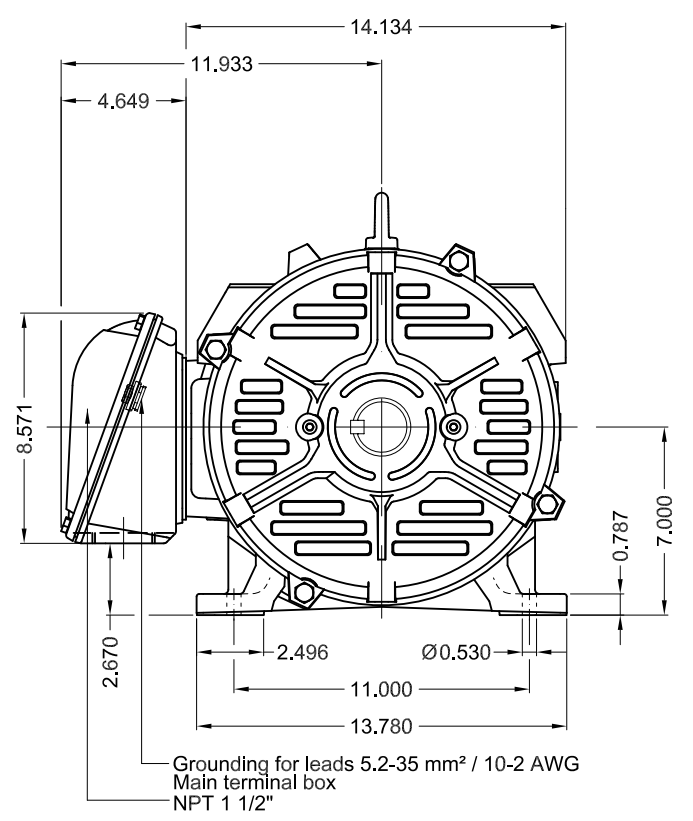

Color RAL 5009
Painting plan 203A
Mounting NEMA F-1
Mounting B3R(D)

20 HP 06 Poles 60 Hz

1:7

ECM	LOC	SUMMARY OF MODIFICATIONS	EXECUTED	CHECKED	RELEASED	DATE	VER
EXECUTED	PIRWBUSER	THREE PH. MOTOR W40 PREM. EFF.					
CHECKED		FRAME 284/6T IP23 ODP					
RELEASED							
REL DT.		WMO Jaragua do Sul	Product Engineering				

PREVIEW
WDD



SHEET 1 / 1

WEG **W40 NEMA**
CC029A Premium
Inverter Duty Motor



IEC 60034-1
 MOD.T01#FOXON



For 60Hz use on PWM, VT 1000:1, CT 3:1, 1.0SF

MODEL 020120T3E286T-W40
 MADE IN BRAZIL
 14494186

PH 3	FR 284/6T	HP(kW) 20.0(15.0)	Hz 60
V 230/460	A 48.6/24.3	RPM 1177	DES B
NEMA NOM EFF 92.4 %	INS. CL. F Δ T 80 K	IP23	
ENCL ODP	DUTY CONT.	AMB. 40°C	
CODE G	PF 0.84	SF 1.25	SFA 60.8/30.4
USABLE @208V	53.7 A	SF 1.15	SFA 61.8
15HP 11kW 50Hz 380V 22.0A 980RPM SF1.00 EFF 90.3% (IE3)	ALT 1000 m.a.s.l.		

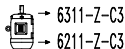
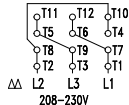

→ 6311-Z-C3
 → 6211-Z-C3

MOBIL POLYREX EM
 18 g 20000 h

ALT 1000 m.a.s.l. 384 Lbs