

DATA SHEET



Three Phase Induction Motor - Squirrel Cage

Customer :							
Product line	: NEMA Premium Efficiency Three-Phase	Product code :	11584354				
		Catalog # :	02509ST3QIE326T-W22				
Frame	: 324/6T	Cooling method	: IC411 - TEFC				
Insulation class	: F	Mounting	: F-1				
Duty cycle	: Cont.(S1)	Rotation ¹	: Both (CW and CCW)				
Ambient temperature	: -20°C to +40°C	Starting method	: Direct On Line				
Altitude	: 1000 m.a.s.l.	Approx. weight ²	: 563 lb				
Protection degree	: IP55	Moment of inertia (J)	: 11.9 sq.ft.lb				
Design	: B						
Output [HP]	25	20	20	20	25	25	25
Poles	8	8	8	8	8	8	8
Frequency [Hz]	60	50	50	50	50	50	50
Rated voltage [V]	460	380	400	415	380	400	415
Rated current [A]	35.9	35.3	35.6	36.4	42.3	41.4	41.1
L. R. Amperes [A]	187	177	192	200	178	190	197
LRC [A]	5.2x(Code G)	5.0x(Code G)	5.4x(Code H)	5.5x(Code J)	4.2x(Code E)	4.6x(Code F)	4.8x(Code G)
No load current [A]	20.0	19.6	22.2	24.6	19.6	22.2	24.6
Rated speed [RPM]	880	730	730	735	725	725	730
Slip [%]	2.22	2.67	2.67	2.00	3.33	3.33	2.67
Rated torque [ft.lb]	149	144	144	143	181	181	180
Locked rotor torque [%]	200	190	210	240	150	170	190
Breakdown torque [%]	229	229	250	280	180	200	220
Service factor	1.25	1.15	1.15	1.15	1.15	1.15	1.15
Temperature rise	80 K	80 K	80 K	80 K	105 K	80 K	80 K
Locked rotor time	41s (cold) 23s (hot)	30s (cold) 17s (hot)	30s (cold) 17s (hot)	30s (cold) 17s (hot)	30s (cold) 17s (hot)	30s (cold) 17s (hot)	30s (cold) 17s (hot)
Noise level ²	56.0 dB(A)	56.0 dB(A)	56.0 dB(A)	56.0 dB(A)	56.0 dB(A)	56.0 dB(A)	56.0 dB(A)
Efficiency (%)	25%						
	50%	89.5	89.3	87.2	86.2	89.5	88.5
	75%	91.0	90.1	89.1	88.6	90.2	89.5
	100%	91.0	89.6	89.6	89.6	88.5	89.5
Power Factor	25%						
	50%	0.51	0.51	0.46	0.42	0.58	0.53
	75%	0.64	0.64	0.59	0.55	0.70	0.66
	100%	0.71	0.71	0.67	0.64	0.75	0.72
Bearing type	: 6312 C3	6212 C3	Foundation loads				
Sealing	: Inpro/Seal	Inpro/Seal	Max. traction	: 1237 lb			
Lubrication interval	: 20000 h	20000 h	Max. compression	: 1800 lb			
Lubricant amount	: 21 g	13 g					
Lubricant type	: Mobil Polyrex EM						
Notes							
This revision replaces and cancel the previous one, which must be eliminated. (1) Looking the motor from the shaft end. (2) Measured at 1m and with tolerance of +3dB(A). (3) Approximate weight subject to changes after manufacturing process. (4) At 100% of full load.				These are average values based on tests with sinusoidal power supply, subject to the tolerances stipulated in NEMA MG-1.			
Rev.	Changes Summary			Performed	Checked	Date	
Performed by							
Checked by					Page	Revision	
Date	14/04/2022				1 / 36		

TORQUE AND CURRENT VS SPEED CURVE

Three Phase Induction Motor - Squirrel Cage



Customer :

Product line : NEMA Premium Efficiency Three-Phase

Product code : 11584354

Catalog # : 02509ST3QIE326T-W22

TORQUE AND CURRENT VS SPEED CURVE

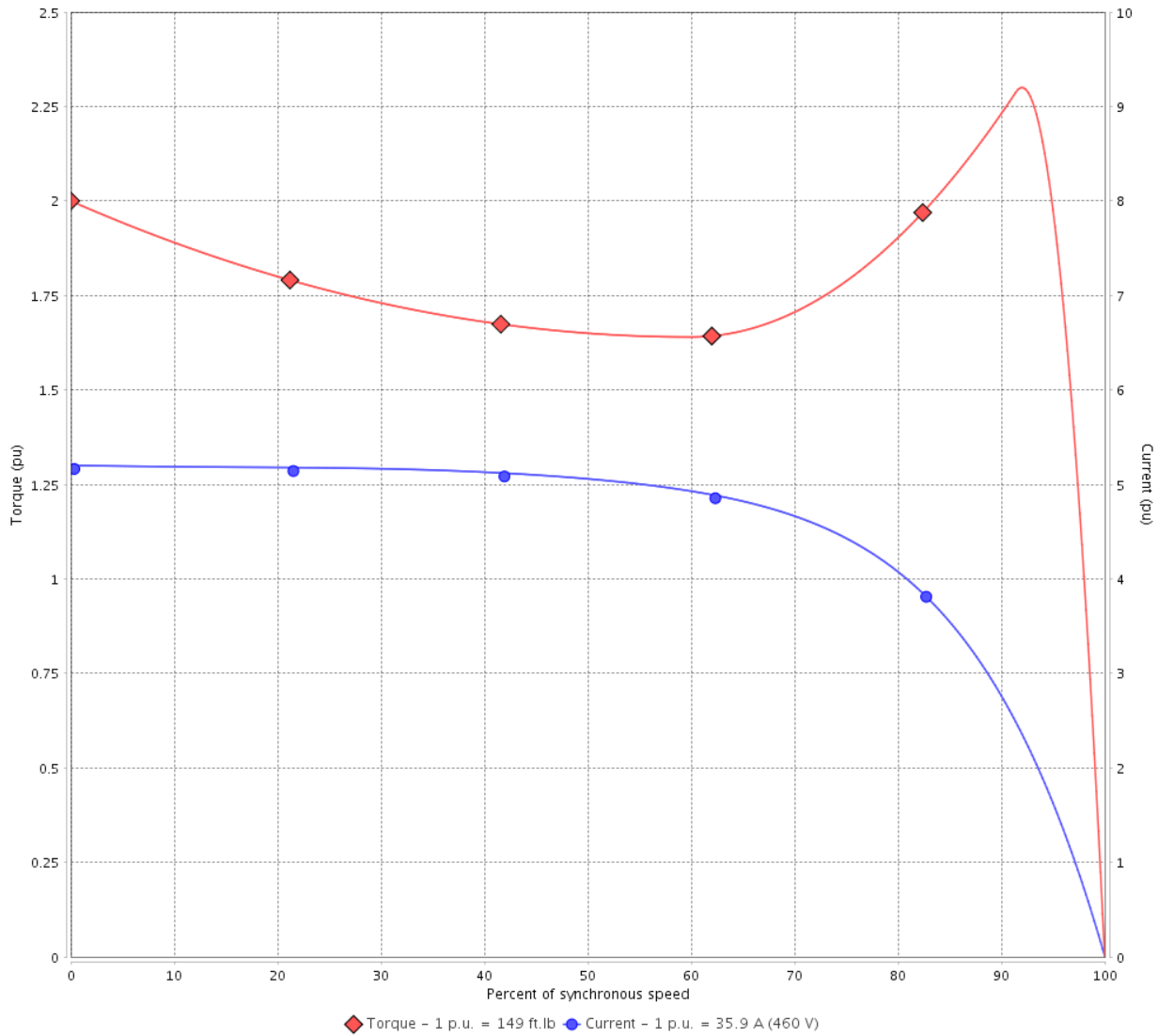

Performance : 460 V 60 Hz 8P

Rated current	: 35.9 A	Moment of inertia (J)	: 11.9 sq.ft.lb
LRC	: 5.2	Duty cycle	: Cont.(S1)
Rated torque	: 149 ft.lb	Insulation class	: F
Locked rotor torque	: 200 %	Service factor	: 1.25
Breakdown torque	: 229 %	Temperature rise	: 80 K
Rated speed	: 880 rpm	Design	: B

Locked rotor time : 41s (cold) 23s (hot)

Rev.	Changes Summary	Performed	Checked	Date
Performed by			Page 2 / 36	Revision
Checked by				
Date	14/04/2022			

TORQUE AND CURRENT VS SPEED CURVE



Three Phase Induction Motor - Squirrel Cage

Customer :

Product line : NEMA Premium Efficiency Three-Phase

Product code : 11584354

Catalog # : 02509ST3QIE326T-W22

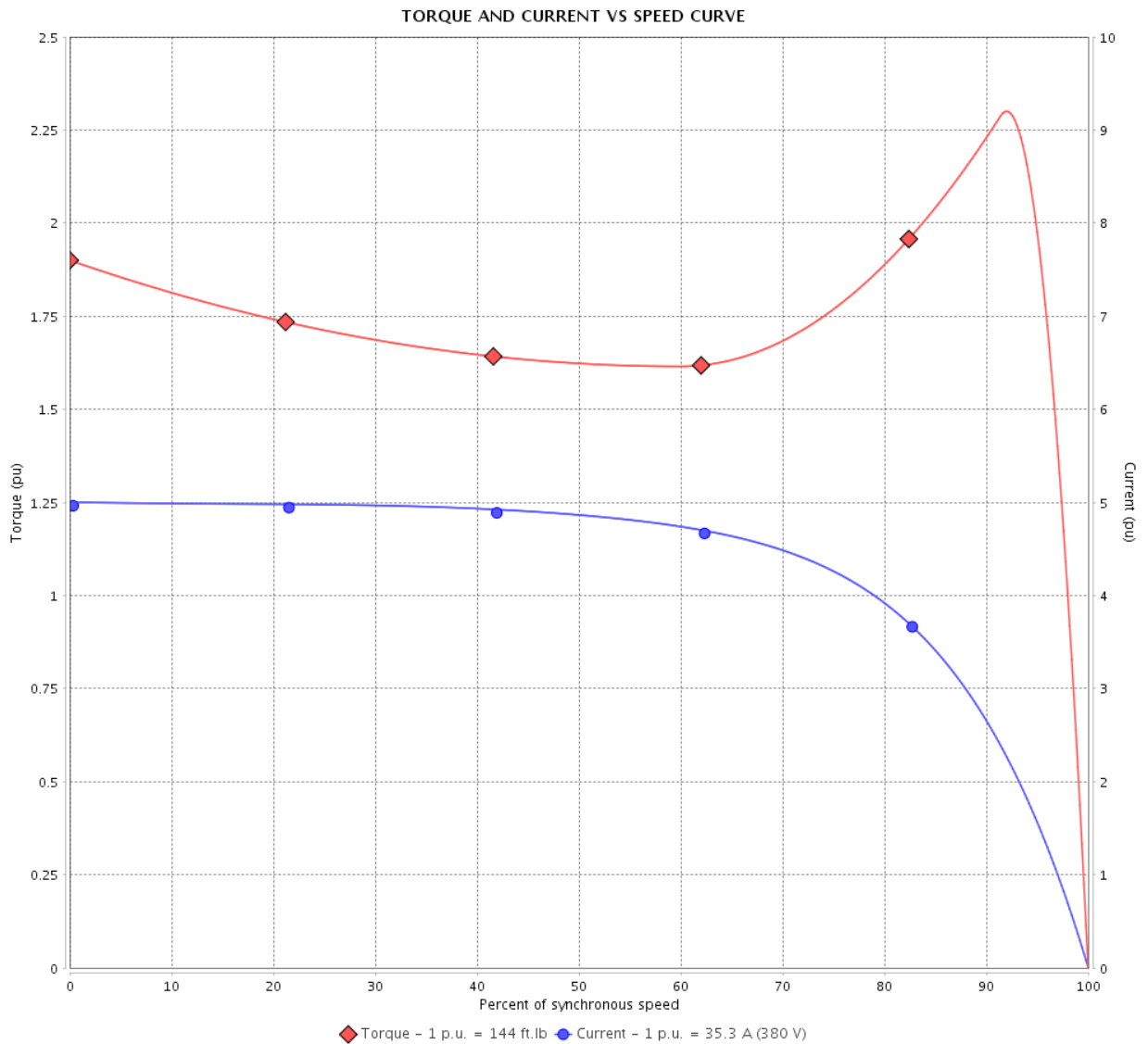

Performance : 380 V 50 Hz 8P IE3

Rated current	: 35.3 A	Moment of inertia (J)	: 11.9 sq.ft.lb
LRC	: 5.0	Duty cycle	: Cont.(S1)
Rated torque	: 144 ft.lb	Insulation class	: F
Locked rotor torque	: 190 %	Service factor	: 1.15
Breakdown torque	: 229 %	Temperature rise	: 80 K
Rated speed	: 730 rpm	Design	: B

Locked rotor time : 30s (cold) 17s (hot)

Rev.	Changes Summary	Performed	Checked	Date
Performed by			Page	Revision
Checked by			3 / 36	
Date	14/04/2022			

TORQUE AND CURRENT VS SPEED CURVE

Three Phase Induction Motor - Squirrel Cage



Customer :

Product line : NEMA Premium Efficiency Three-Phase

Product code : 11584354

Catalog # : 02509ST3QIE326T-W22

TORQUE AND CURRENT VS SPEED CURVE

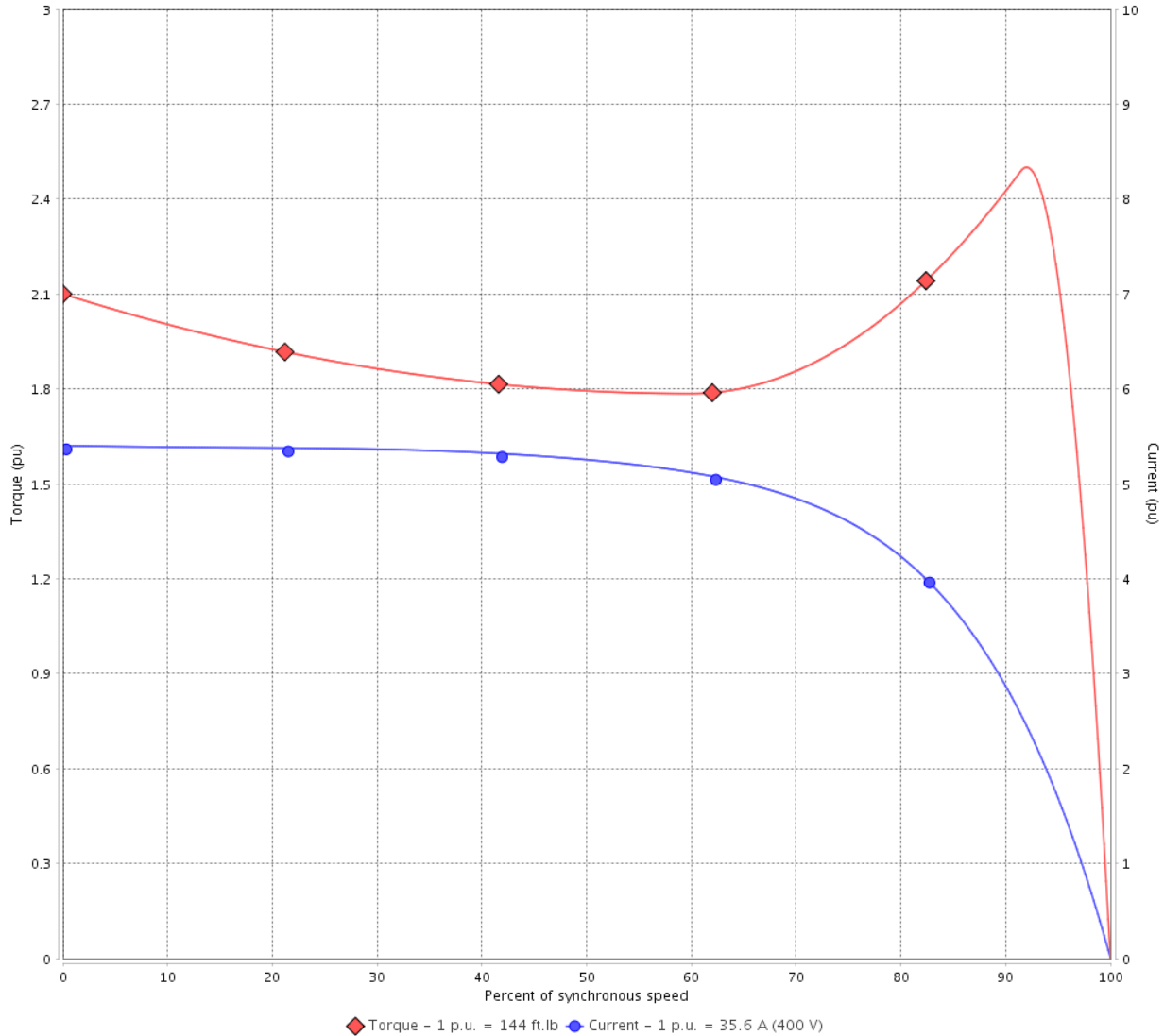

Performance : 400 V 50 Hz 8P IE3

Rated current	: 35.6 A	Moment of inertia (J)	: 11.9 sq.ft.lb
LRC	: 5.4	Duty cycle	: Cont.(S1)
Rated torque	: 144 ft.lb	Insulation class	: F
Locked rotor torque	: 210 %	Service factor	: 1.15
Breakdown torque	: 250 %	Temperature rise	: 80 K
Rated speed	: 730 rpm	Design	: B

Locked rotor time : 30s (cold) 17s (hot)

Rev.	Changes Summary	Performed	Checked	Date
Performed by			Page 4 / 36	Revision
Checked by				
Date	14/04/2022			

TORQUE AND CURRENT VS SPEED CURVE



Three Phase Induction Motor - Squirrel Cage

Customer :

Product line : NEMA Premium Efficiency Three-Phase

Product code : 11584354

Catalog # : 02509ST3QIE326T-W22

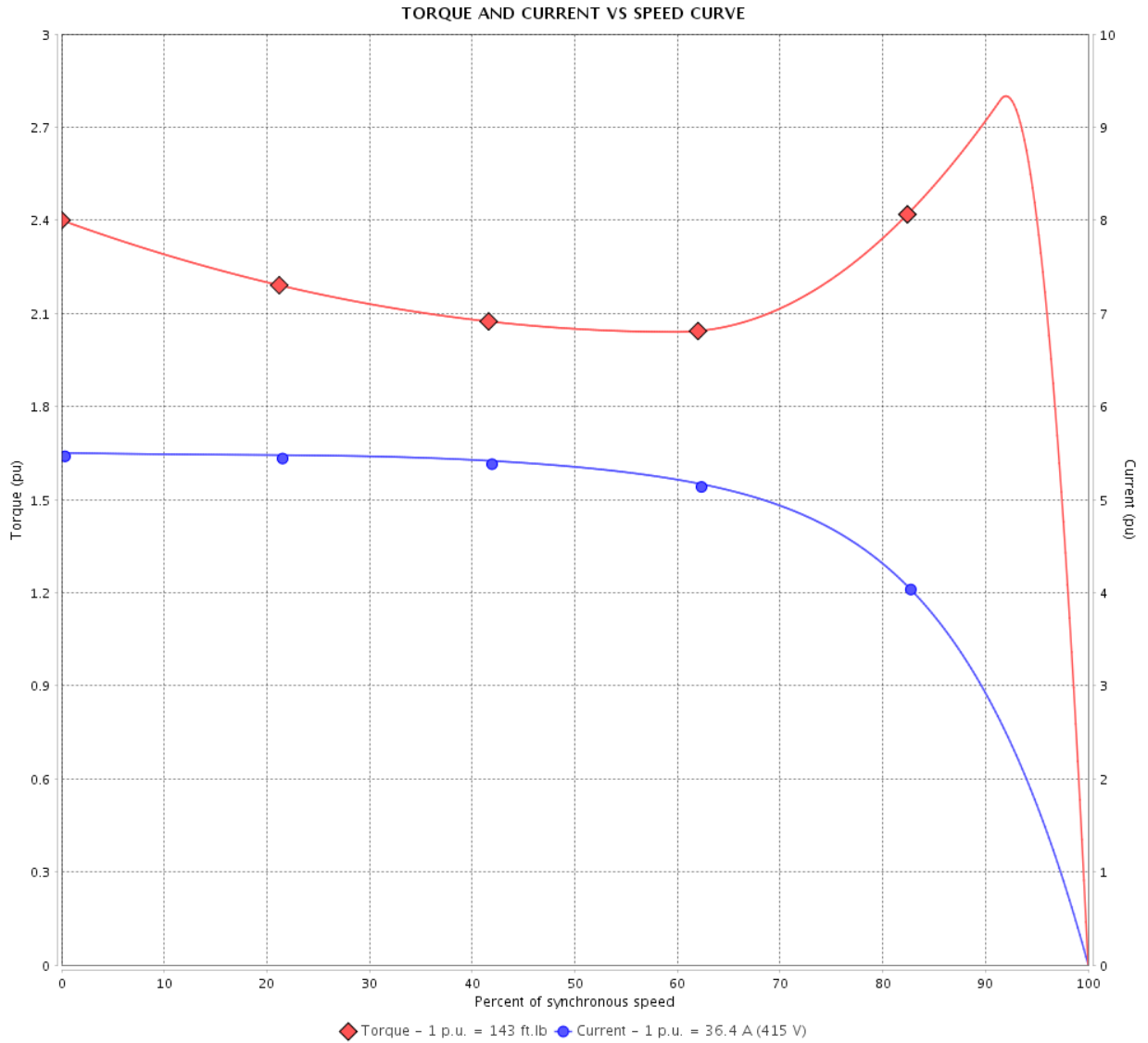

Performance : 415 V 50 Hz 8P IE3

Rated current	: 36.4 A	Moment of inertia (J)	: 11.9 sq.ft.lb
LRC	: 5.5	Duty cycle	: Cont.(S1)
Rated torque	: 143 ft.lb	Insulation class	: F
Locked rotor torque	: 240 %	Service factor	: 1.15
Breakdown torque	: 280 %	Temperature rise	: 80 K
Rated speed	: 735 rpm	Design	: B

Locked rotor time : 30s (cold) 17s (hot)

Rev.	Changes Summary	Performed	Checked	Date
Performed by			Page 5 / 36	Revision
Checked by				
Date	14/04/2022			

TORQUE AND CURRENT VS SPEED CURVE

Three Phase Induction Motor - Squirrel Cage



Customer :

Product line : NEMA Premium Efficiency Three-Phase

Product code : 11584354

Catalog # : 02509ST3QIE326T-W22

TORQUE AND CURRENT VS SPEED CURVE

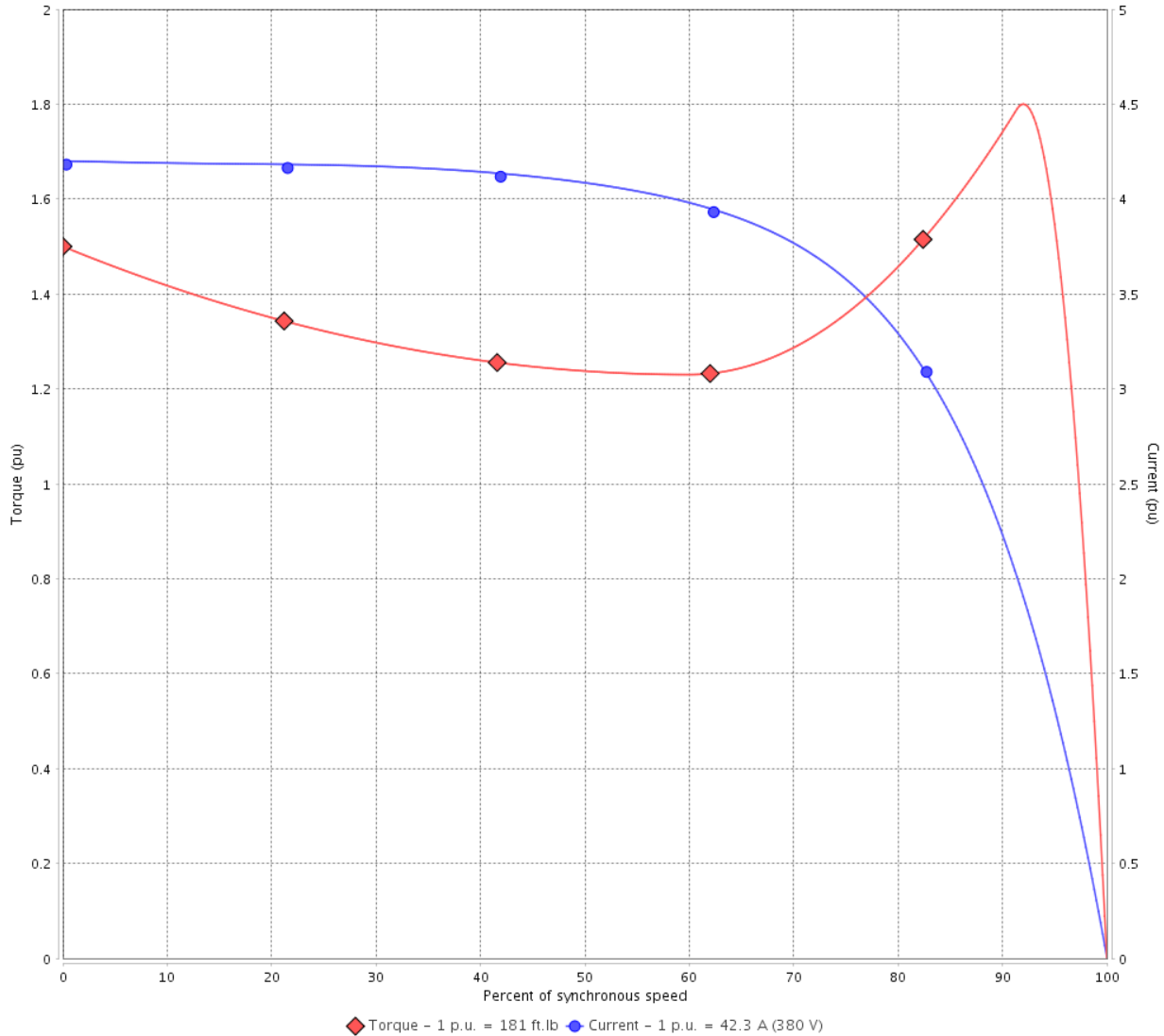

Performance : 380 V 50 Hz 8P IE1

Rated current	: 42.3 A	Moment of inertia (J)	: 11.9 sq.ft.lb
LRC	: 4.2	Duty cycle	: Cont.(S1)
Rated torque	: 181 ft.lb	Insulation class	: F
Locked rotor torque	: 150 %	Service factor	: 1.15
Breakdown torque	: 180 %	Temperature rise	: 105 K
Rated speed	: 725 rpm	Design	: B

Locked rotor time : 30s (cold) 17s (hot)

Rev.	Changes Summary	Performed	Checked	Date
Performed by			Page 6 / 36	Revision
Checked by				
Date	14/04/2022			

TORQUE AND CURRENT VS SPEED CURVE



Three Phase Induction Motor - Squirrel Cage

Customer :

Product line : NEMA Premium Efficiency Three-Phase

Product code : 11584354

Catalog # : 02509ST3QIE326T-W22

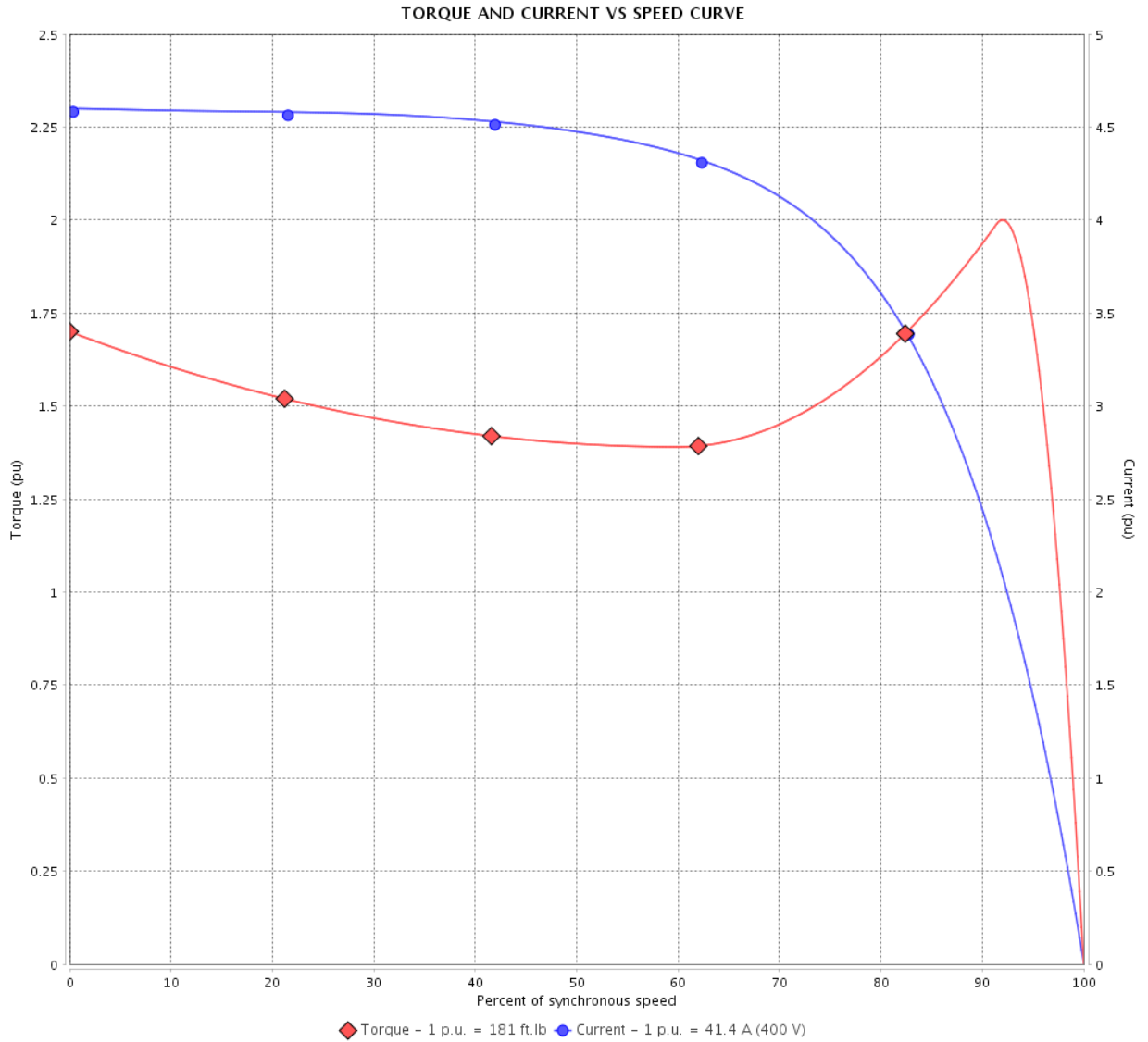

Performance : 400 V 50 Hz 8P IE2

Rated current	: 41.4 A	Moment of inertia (J)	: 11.9 sq.ft.lb
LRC	: 4.6	Duty cycle	: Cont.(S1)
Rated torque	: 181 ft.lb	Insulation class	: F
Locked rotor torque	: 170 %	Service factor	: 1.15
Breakdown torque	: 200 %	Temperature rise	: 80 K
Rated speed	: 725 rpm	Design	: B

Locked rotor time : 30s (cold) 17s (hot)

Rev.	Changes Summary	Performed	Checked	Date
Performed by			Page 7 / 36	Revision
Checked by				
Date	14/04/2022			

TORQUE AND CURRENT VS SPEED CURVE

Three Phase Induction Motor - Squirrel Cage



Customer :

Product line : NEMA Premium Efficiency Three-Phase

Product code : 11584354

Catalog # : 02509ST3QIE326T-W22

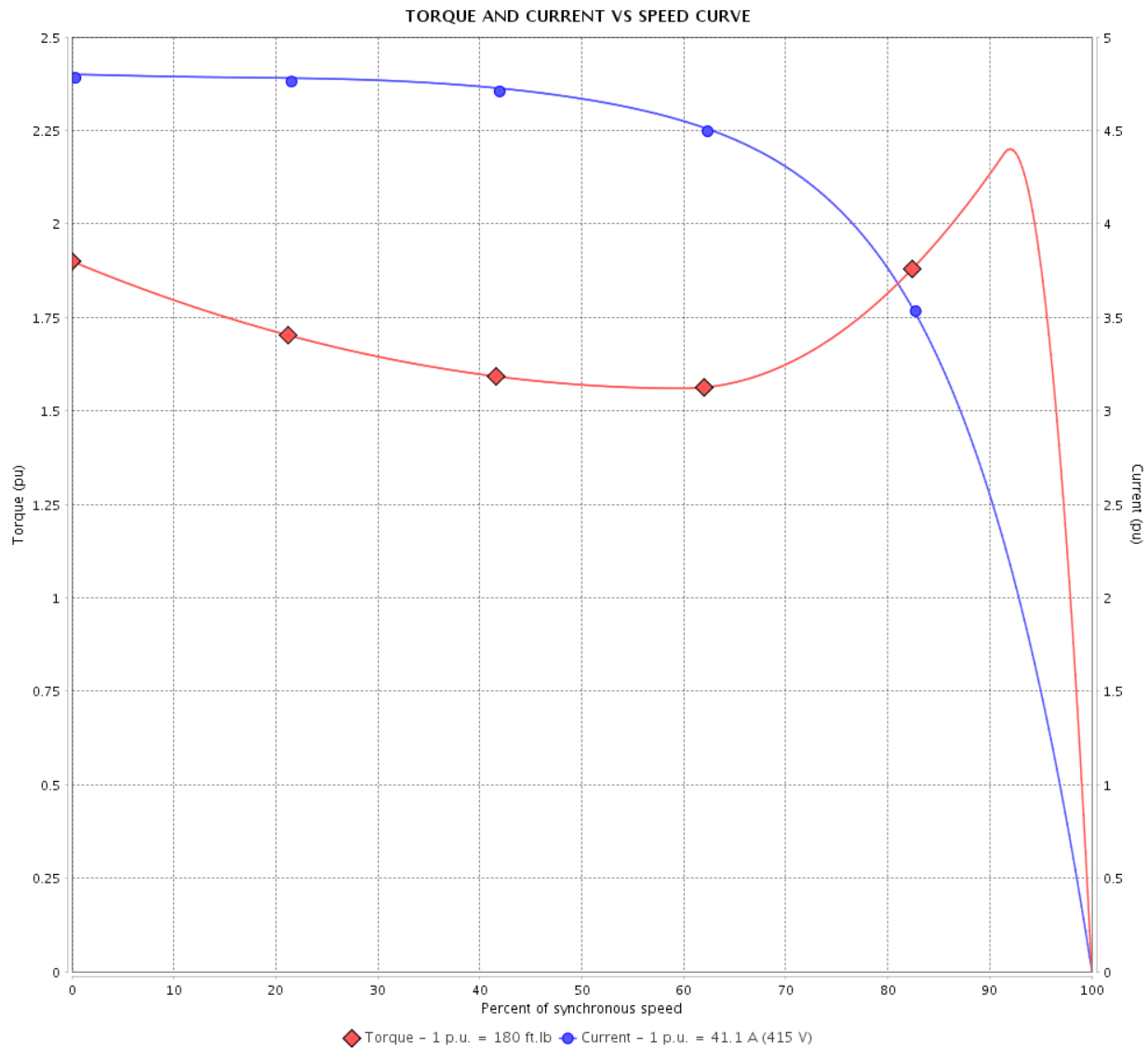

Performance : 415 V 50 Hz 8P IE2

Rated current	: 41.1 A	Moment of inertia (J)	: 11.9 sq.ft.lb
LRC	: 4.8	Duty cycle	: Cont.(S1)
Rated torque	: 180 ft.lb	Insulation class	: F
Locked rotor torque	: 190 %	Service factor	: 1.15
Breakdown torque	: 220 %	Temperature rise	: 80 K
Rated speed	: 730 rpm	Design	: B

Locked rotor time : 30s (cold) 17s (hot)

Rev.	Changes Summary	Performed	Checked	Date
Performed by			Page 8 / 36	Revision
Checked by				
Date	14/04/2022			

LOAD PERFORMANCE CURVE

Three Phase Induction Motor - Squirrel Cage



Customer : _____

Product line : NEMA Premium Efficiency Three-Phase

Product code : 11584354

Catalog # : 02509ST3QIE326T-W22

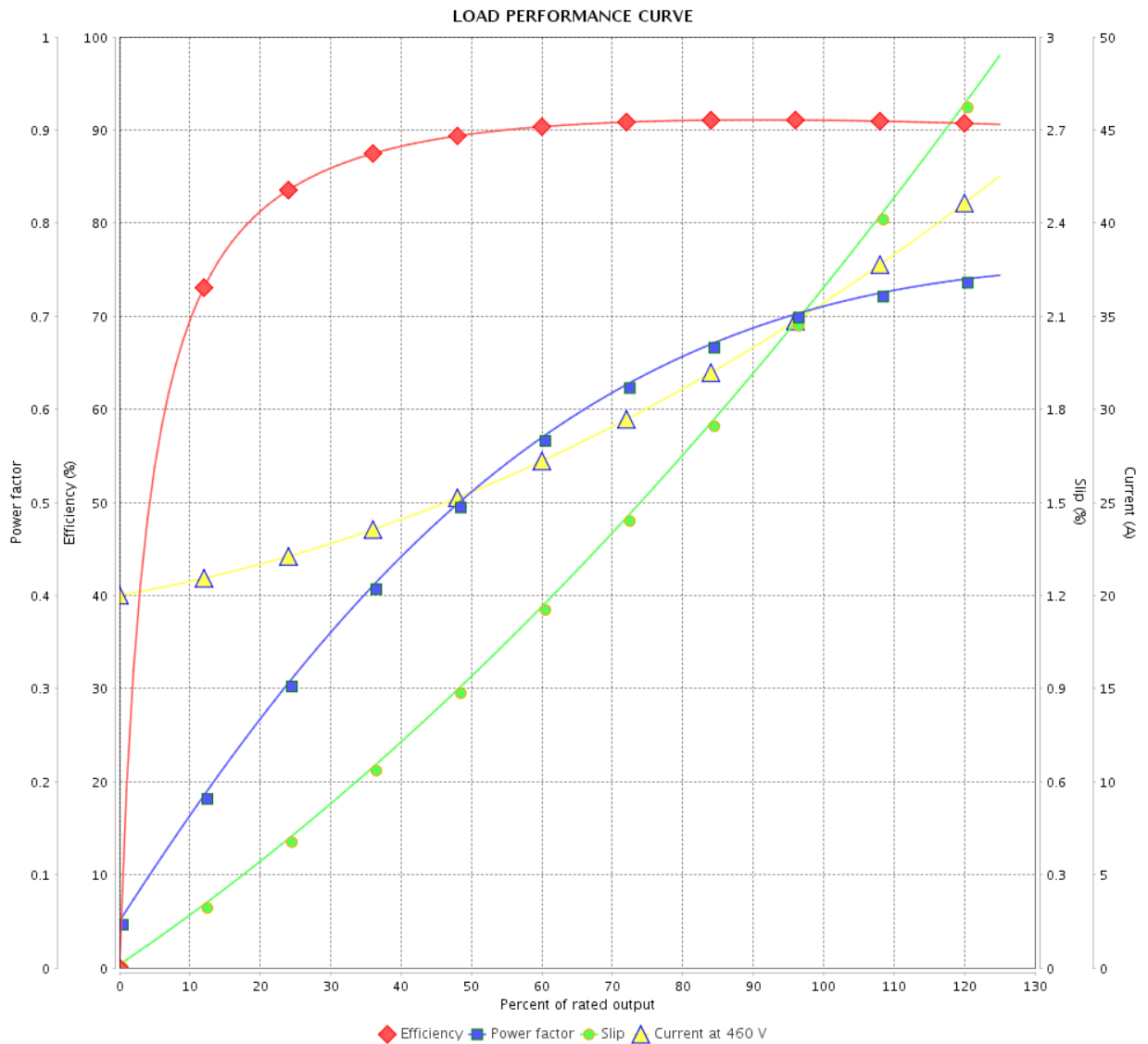

Performance : 460 V 60 Hz 8P

Rated current : 35.9 A
 LRC : 5.2
 Rated torque : 149 ft.lb
 Locked rotor torque : 200 %
 Breakdown torque : 229 %
 Rated speed : 880 rpm

Moment of inertia (J) : 11.9 sq.ft.lb
 Duty cycle : Cont.(S1)
 Insulation class : F
 Service factor : 1.25
 Temperature rise : 80 K
 Design : B

Rev.	Changes Summary	Performed	Checked	Date
Performed by		Page		Revision
Checked by		9 / 36		
Date		14/04/2022		

LOAD PERFORMANCE CURVE

Three Phase Induction Motor - Squirrel Cage



Customer : _____

Product line : NEMA Premium Efficiency Three-Phase

Product code : 11584354

Catalog # : 02509ST3QIE326T-W22

LOAD PERFORMANCE CURVE

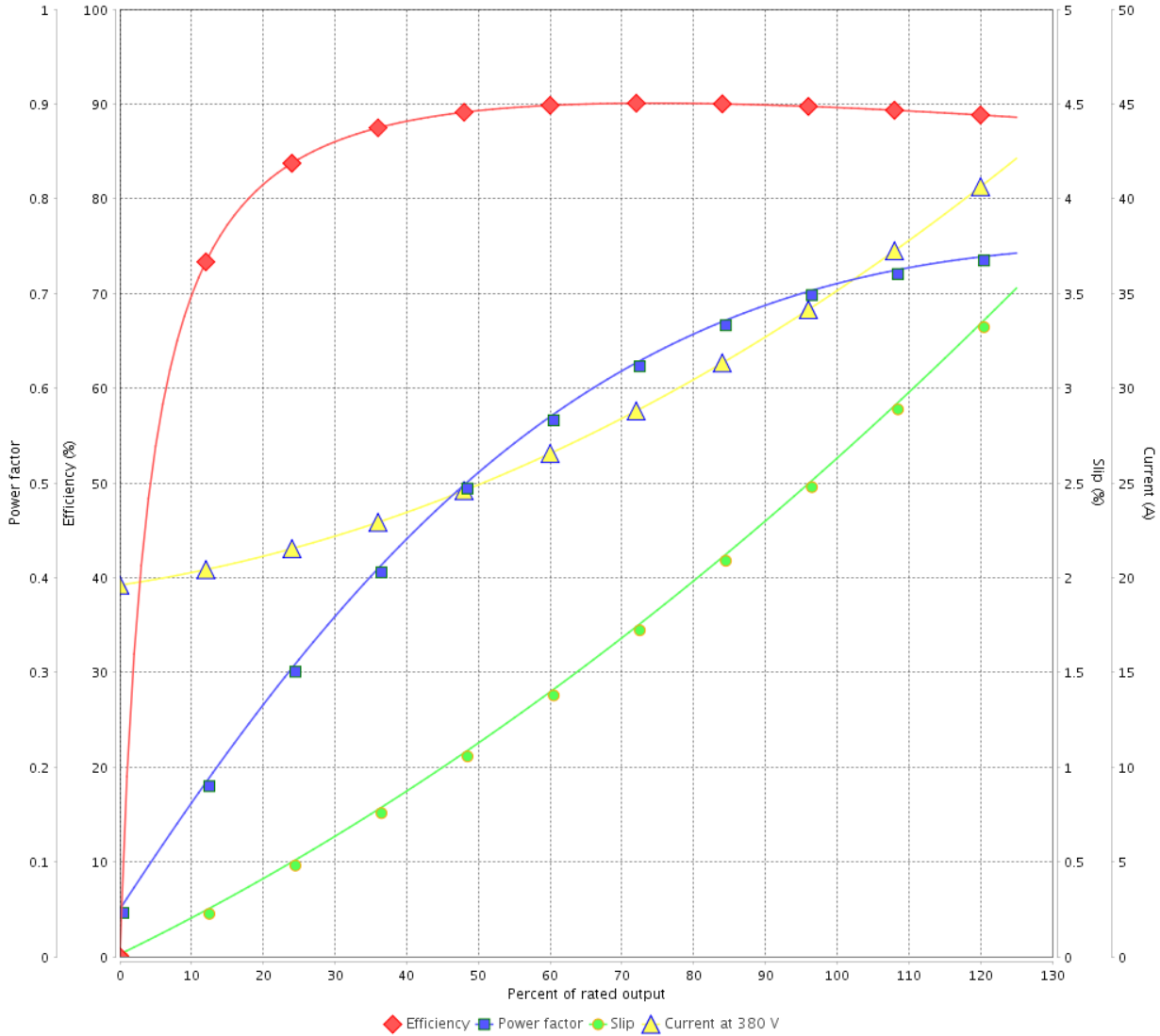

Performance : 380 V 50 Hz 8P IE3

Rated current : 35.3 A
 LRC : 5.0
 Rated torque : 144 ft.lb
 Locked rotor torque : 190 %
 Breakdown torque : 229 %
 Rated speed : 730 rpm

Moment of inertia (J) : 11.9 sq.ft.lb
 Duty cycle : Cont.(S1)
 Insulation class : F
 Service factor : 1.15
 Temperature rise : 80 K
 Design : B

Rev.	Changes Summary	Performed	Checked	Date
Performed by			Page 10 / 36	Revision
Checked by				
Date	14/04/2022			

LOAD PERFORMANCE CURVE

Three Phase Induction Motor - Squirrel Cage



Customer :

Product line : NEMA Premium Efficiency Three-Phase

Product code : 11584354

Catalog # : 02509ST3QIE326T-W22

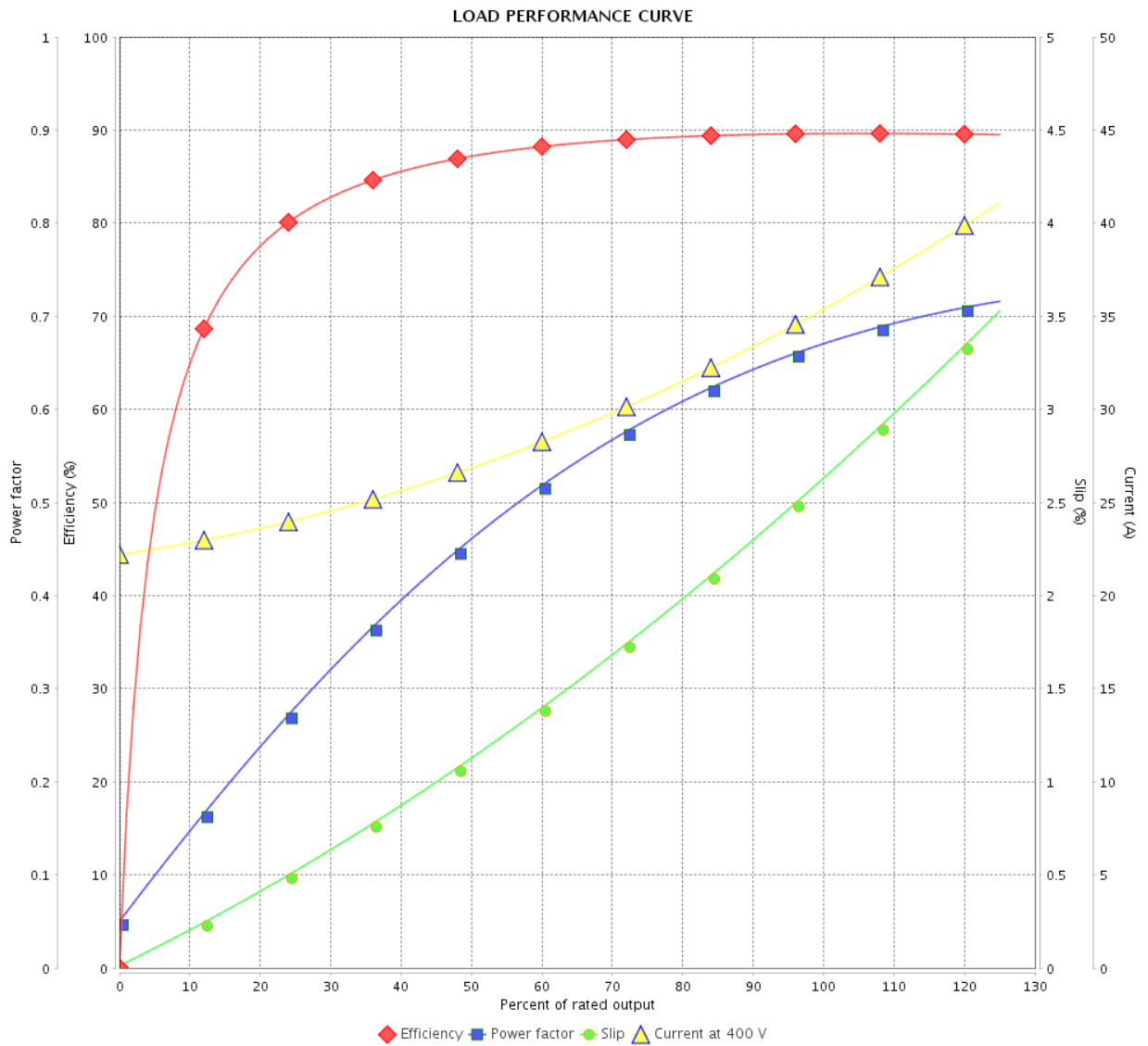

Performance : 400 V 50 Hz 8P IE3

Rated current : 35.6 A
 LRC : 5.4
 Rated torque : 144 ft.lb
 Locked rotor torque : 210 %
 Breakdown torque : 250 %
 Rated speed : 730 rpm

Moment of inertia (J) : 11.9 sq.ft.lb
 Duty cycle : Cont.(S1)
 Insulation class : F
 Service factor : 1.15
 Temperature rise : 80 K
 Design : B

Rev.	Changes Summary	Performed	Checked	Date
Performed by		Page		Revision
Checked by		11 / 36		
Date		14/04/2022		

LOAD PERFORMANCE CURVE

Three Phase Induction Motor - Squirrel Cage



Customer : _____

Product line : NEMA Premium Efficiency Three-Phase

Product code : 11584354

Catalog # : 02509ST3QIE326T-W22

LOAD PERFORMANCE CURVE

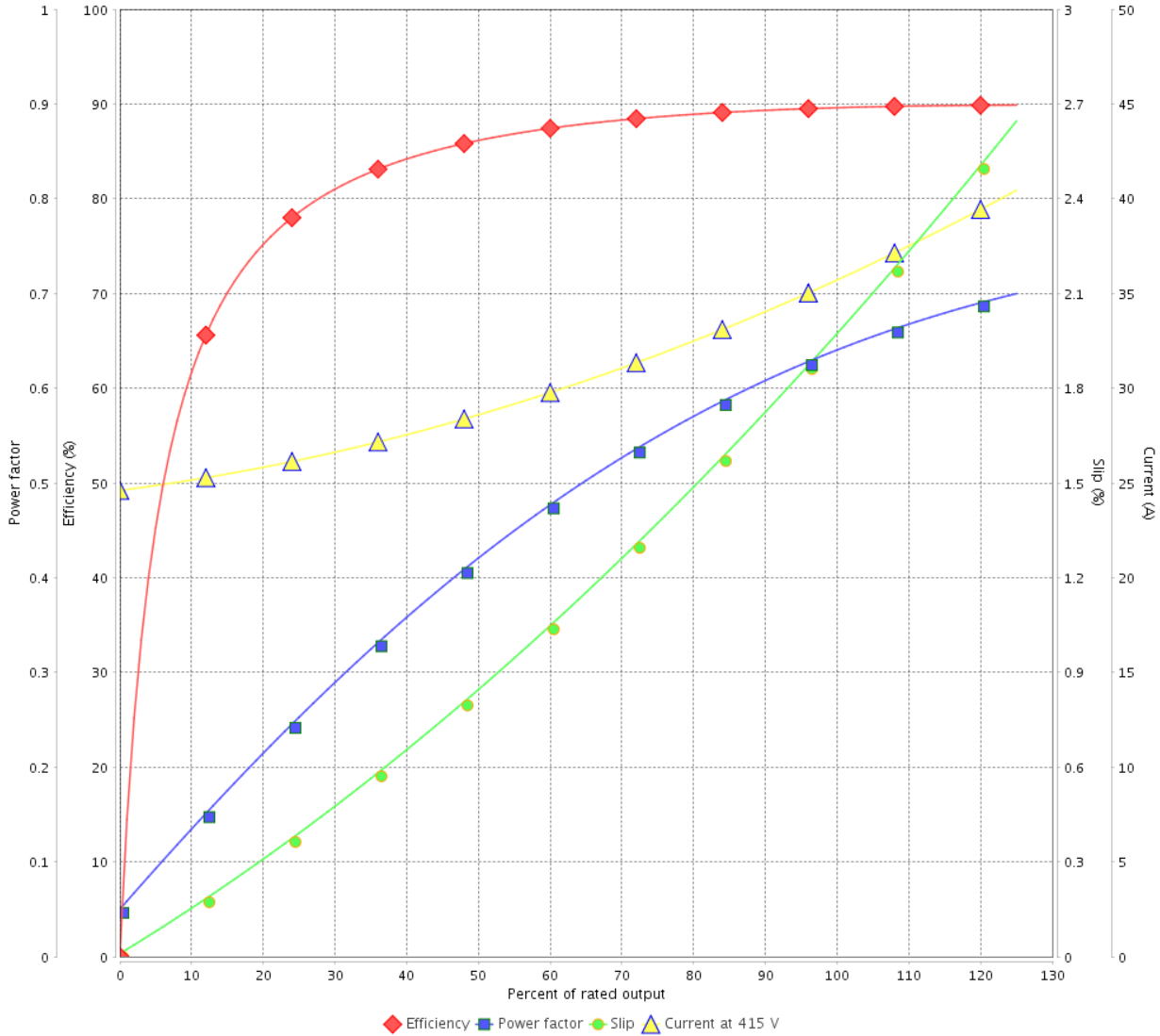

Performance : 415 V 50 Hz 8P IE3

Rated current : 36.4 A
 LRC : 5.5
 Rated torque : 143 ft.lb
 Locked rotor torque : 240 %
 Breakdown torque : 280 %
 Rated speed : 735 rpm

Moment of inertia (J) : 11.9 sq.ft.lb
 Duty cycle : Cont.(S1)
 Insulation class : F
 Service factor : 1.15
 Temperature rise : 80 K
 Design : B

Rev.	Changes Summary	Performed	Checked	Date
Performed by			Page	Revision
Checked by				
Date				

LOAD PERFORMANCE CURVE

Three Phase Induction Motor - Squirrel Cage



Customer :

Product line : NEMA Premium Efficiency Three-Phase

Product code : 11584354

Catalog # : 02509ST3QIE326T-W22

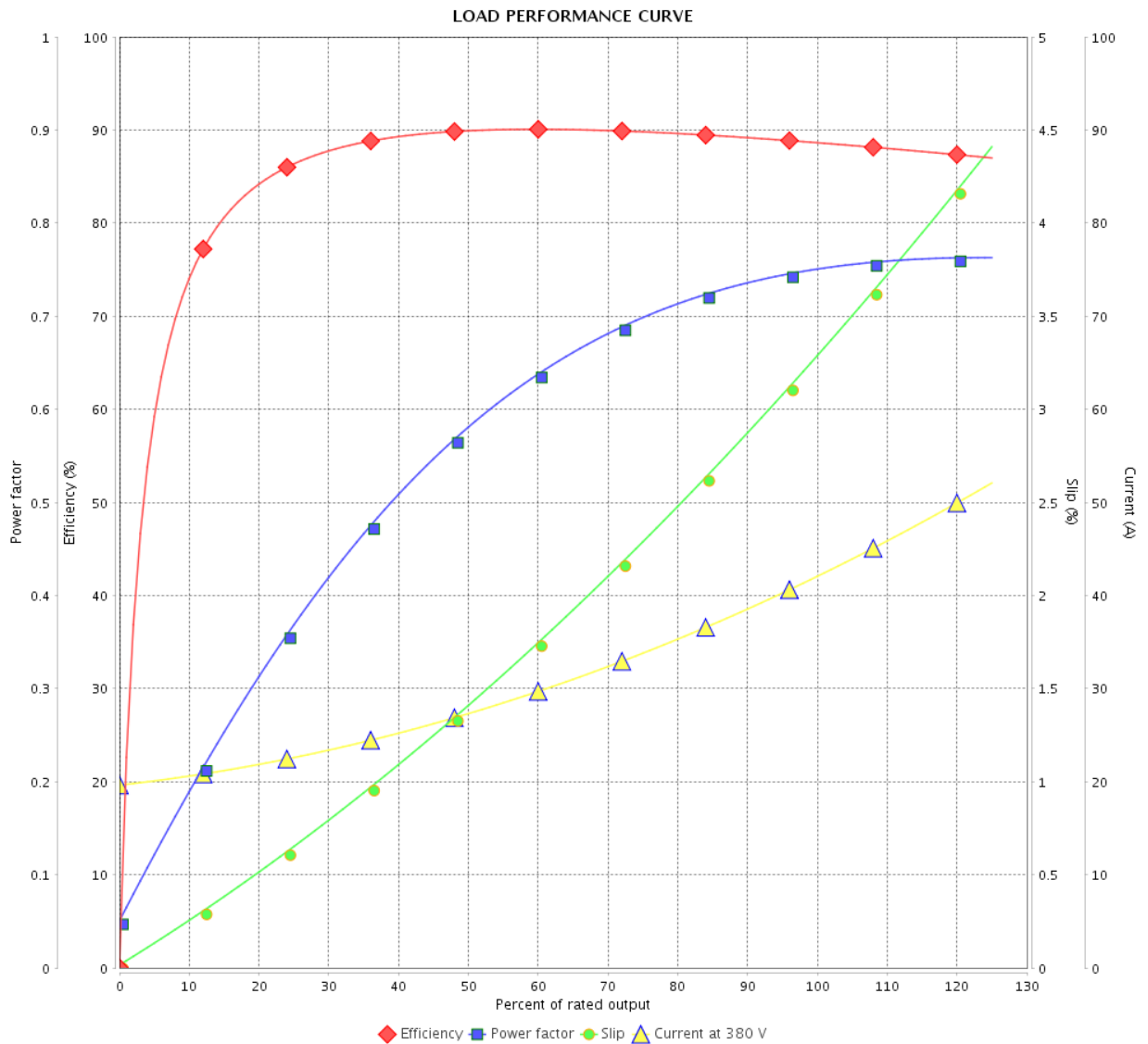

Performance : 380 V 50 Hz 8P IE1

Rated current : 42.3 A
 LRC : 4.2
 Rated torque : 181 ft.lb
 Locked rotor torque : 150 %
 Breakdown torque : 180 %
 Rated speed : 725 rpm

Moment of inertia (J) : 11.9 sq.ft.lb
 Duty cycle : Cont.(S1)
 Insulation class : F
 Service factor : 1.15
 Temperature rise : 105 K
 Design : B

Rev.	Changes Summary	Performed	Checked	Date
Performed by		Page		Revision
Checked by		13 / 36		
Date		14/04/2022		

LOAD PERFORMANCE CURVE

Three Phase Induction Motor - Squirrel Cage



Customer :

Product line : NEMA Premium Efficiency Three-Phase

Product code : 11584354

Catalog # : 02509ST3QIE326T-W22

LOAD PERFORMANCE CURVE

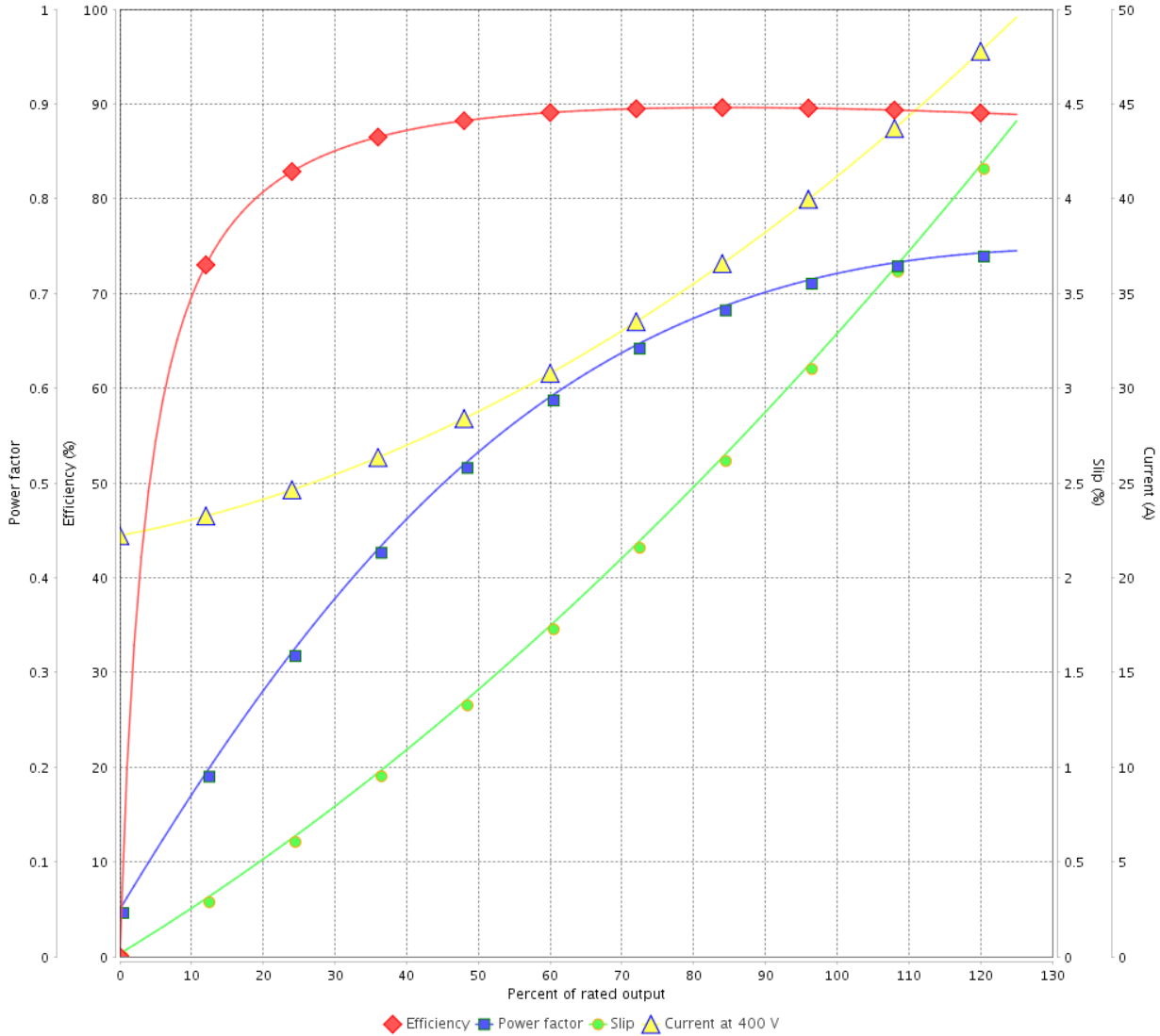

Performance : 400 V 50 Hz 8P IE2

Rated current : 41.4 A
 LRC : 4.6
 Rated torque : 181 ft.lb
 Locked rotor torque : 170 %
 Breakdown torque : 200 %
 Rated speed : 725 rpm

Moment of inertia (J) : 11.9 sq.ft.lb
 Duty cycle : Cont.(S1)
 Insulation class : F
 Service factor : 1.15
 Temperature rise : 80 K
 Design : B

Rev.	Changes Summary	Performed	Checked	Date
Performed by			Page	Revision
Checked by			14 / 36	
Date	14/04/2022			

LOAD PERFORMANCE CURVE

Three Phase Induction Motor - Squirrel Cage



Customer :

Product line : NEMA Premium Efficiency Three-Phase

Product code : 11584354

Catalog # : 02509ST3QIE326T-W22

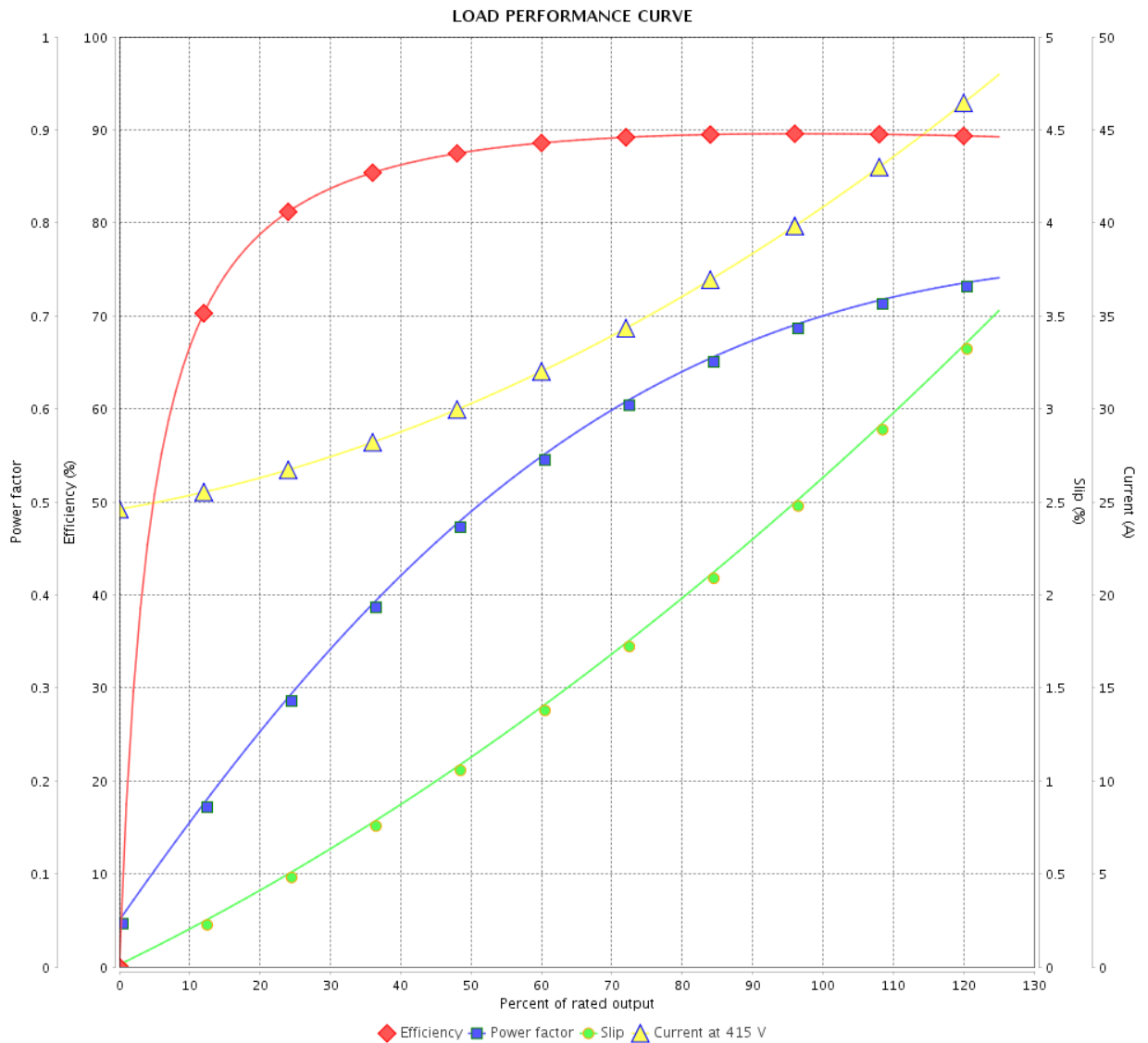

Performance : 415 V 50 Hz 8P IE2

Rated current : 41.1 A
 LRC : 4.8
 Rated torque : 180 ft.lb
 Locked rotor torque : 190 %
 Breakdown torque : 220 %
 Rated speed : 730 rpm

Moment of inertia (J) : 11.9 sq.ft.lb
 Duty cycle : Cont.(S1)
 Insulation class : F
 Service factor : 1.15
 Temperature rise : 80 K
 Design : B

Rev.	Changes Summary	Performed	Checked	Date
Performed by			Page	Revision
Checked by			15 / 36	
Date	14/04/2022			

THERMAL LIMIT CURVE



Three Phase Induction Motor - Squirrel Cage

Customer :

Product line : NEMA Premium Efficiency Three-Phase

Product code : 11584354

Catalog # : 02509ST3QIE326T-W22

Performance : 460 V 60 Hz 8P

Rated current	: 35.9 A	Moment of inertia (J)	: 11.9 sq.ft.lb
LRC	: 5.2	Duty cycle	: Cont.(S1)
Rated torque	: 149 ft.lb	Insulation class	: F
Locked rotor torque	: 200 %	Service factor	: 1.25
Breakdown torque	: 229 %	Temperature rise	: 80 K
Rated speed	: 880 rpm	Design	: B

Heating constant

Cooling constant

Rev.	Changes Summary	Performed	Checked	Date
Performed by				
Checked by			Page	Revision
Date	14/04/2022		16 / 36	

THERMAL LIMIT CURVE

Three Phase Induction Motor - Squirrel Cage



Customer : _____

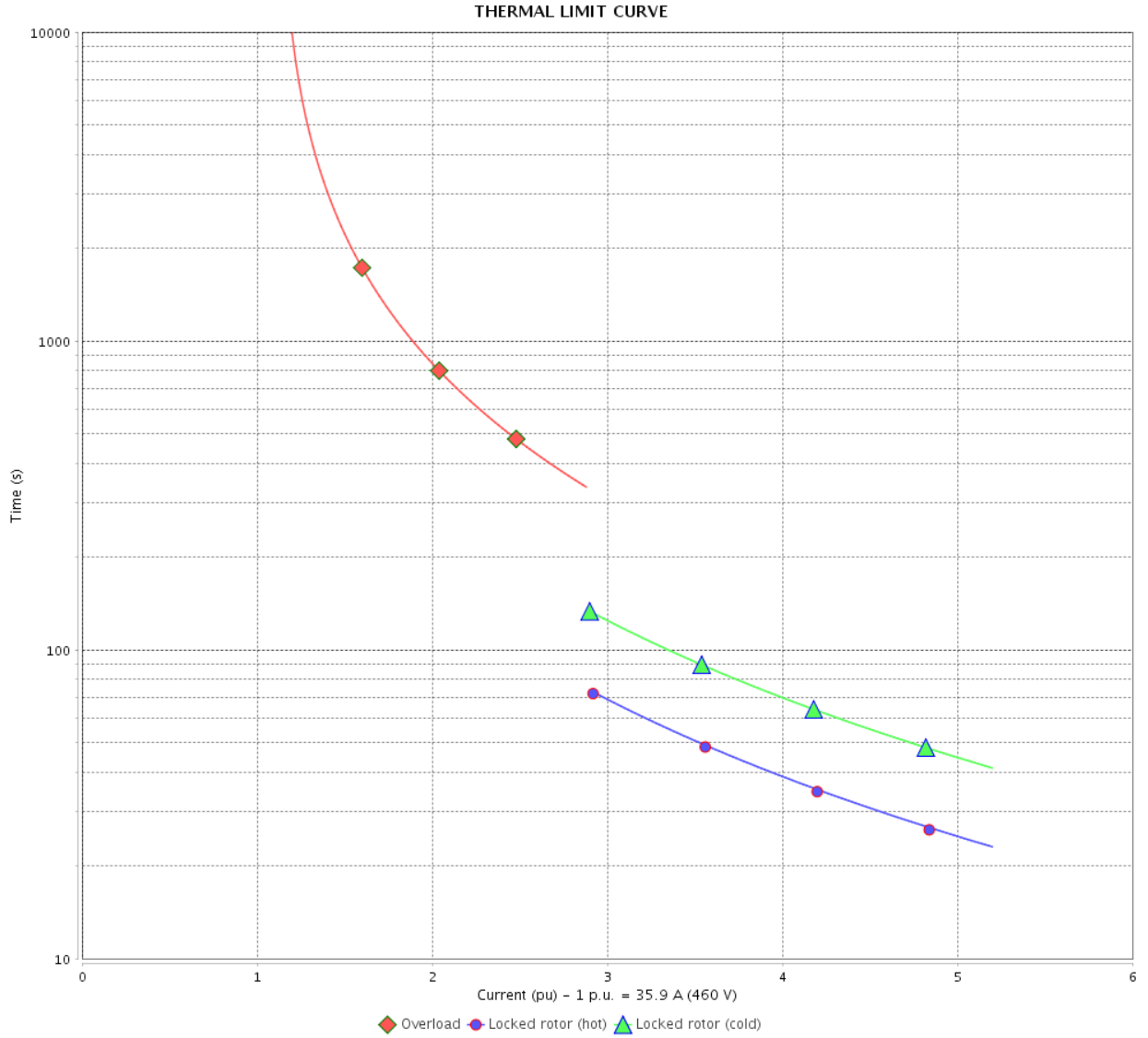

Rev.	Changes Summary	Performed	Checked	Date
Performed by		Page 17 / 36		Revision
Checked by				
Date				

THERMAL LIMIT CURVE

Three Phase Induction Motor - Squirrel Cage



Customer :

Product line : NEMA Premium Efficiency Three-Phase

Product code : 11584354

Catalog # : 02509ST3QIE326T-W22

Performance : 380 V 50 Hz 8P IE3

Rated current	: 35.3 A	Moment of inertia (J)	: 11.9 sq.ft.lb
LRC	: 5.0	Duty cycle	: Cont.(S1)
Rated torque	: 144 ft.lb	Insulation class	: F
Locked rotor torque	: 190 %	Service factor	: 1.15
Breakdown torque	: 229 %	Temperature rise	: 80 K
Rated speed	: 730 rpm	Design	: B

Heating constant

Cooling constant

Rev.	Changes Summary	Performed	Checked	Date
Performed by				
Checked by			Page	Revision
Date	14/04/2022		18 / 36	

THERMAL LIMIT CURVE

Three Phase Induction Motor - Squirrel Cage



Customer : _____

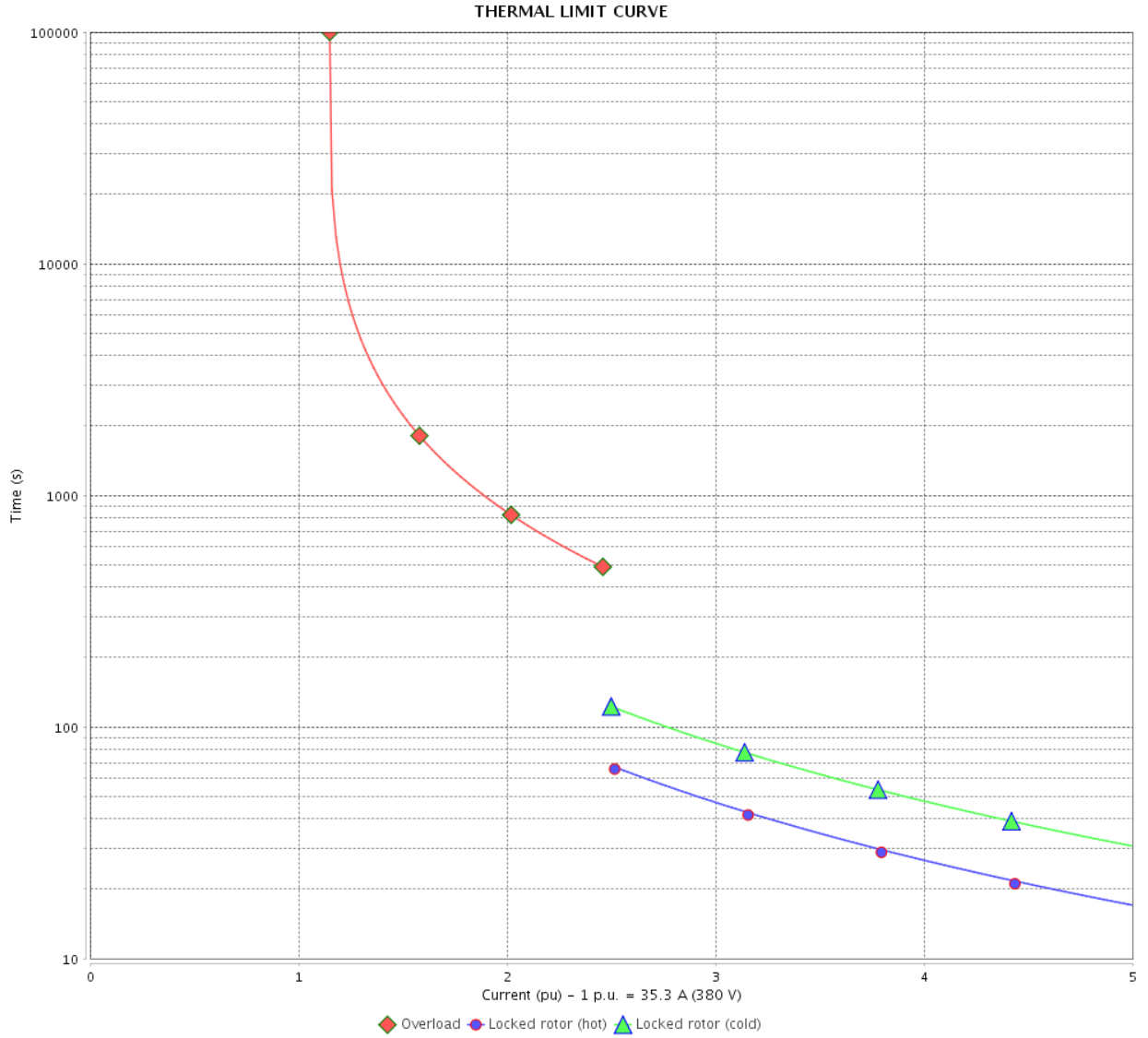

Rev.	Changes Summary	Performed	Checked	Date
Performed by		Page		Revision
Checked by		19 / 36		
Date		14/04/2022		

THERMAL LIMIT CURVE



Three Phase Induction Motor - Squirrel Cage

Customer :

Product line : NEMA Premium Efficiency Three-Phase

Product code : 11584354

Catalog # : 02509ST3QIE326T-W22

Performance : 400 V 50 Hz 8P IE3

Rated current	: 35.6 A	Moment of inertia (J)	: 11.9 sq.ft.lb
LRC	: 5.4	Duty cycle	: Cont.(S1)
Rated torque	: 144 ft.lb	Insulation class	: F
Locked rotor torque	: 210 %	Service factor	: 1.15
Breakdown torque	: 250 %	Temperature rise	: 80 K
Rated speed	: 730 rpm	Design	: B

Heating constant

Cooling constant

Rev.	Changes Summary	Performed	Checked	Date
Performed by				
Checked by			Page	Revision
Date	14/04/2022		20 / 36	

THERMAL LIMIT CURVE

Three Phase Induction Motor - Squirrel Cage



Customer : _____

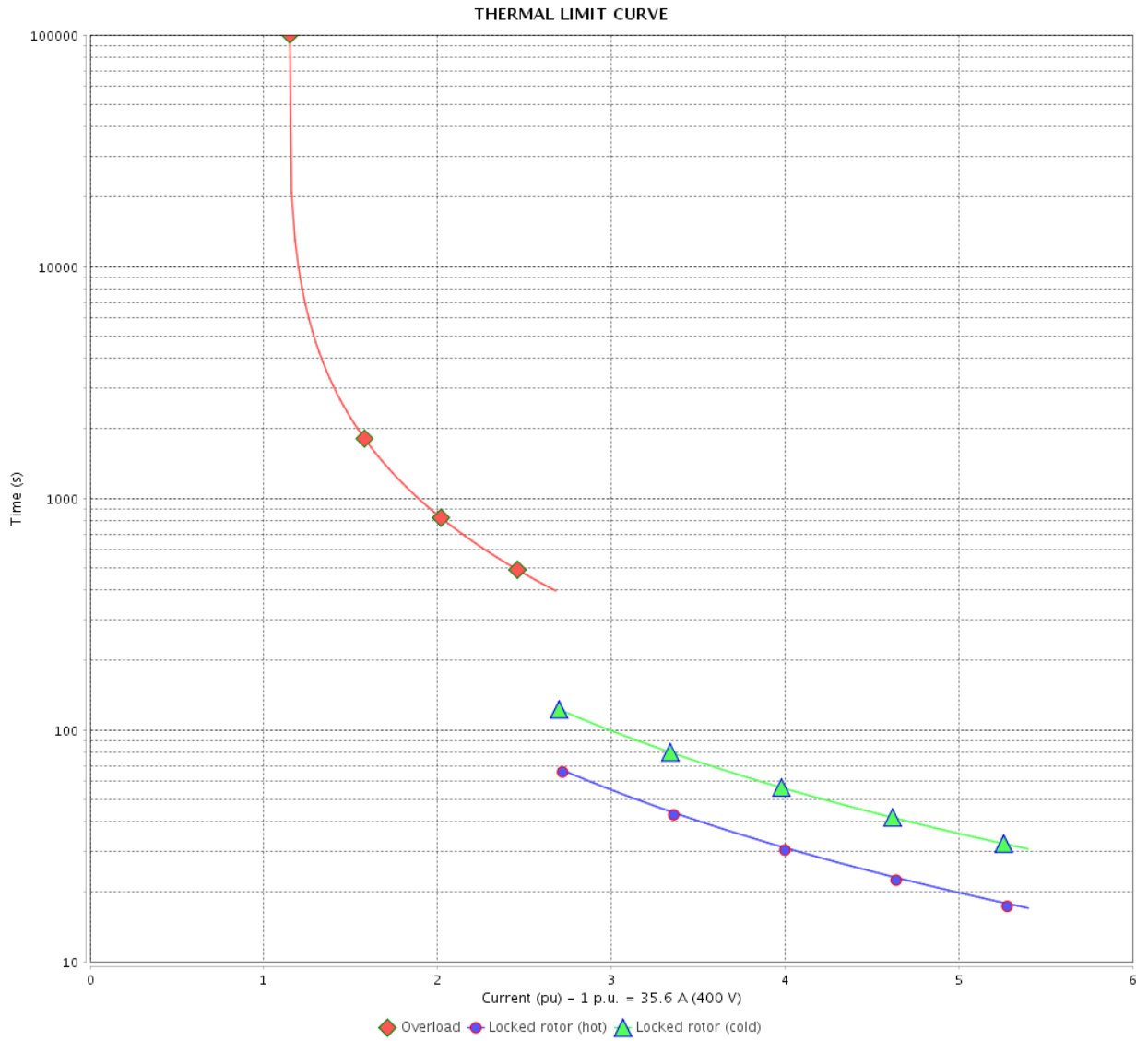

Rev.	Changes Summary	Performed	Checked	Date
Performed by		Page		Revision
Checked by		21 / 36		
Date		14/04/2022		

THERMAL LIMIT CURVE

Three Phase Induction Motor - Squirrel Cage



Customer :

Product line : NEMA Premium Efficiency Three-Phase
Product code : 11584354
Catalog # : 02509ST3QIE326T-W22

Performance : 415 V 50 Hz 8P IE3

Rated current	: 36.4 A	Moment of inertia (J)	: 11.9 sq.ft.lb
LRC	: 5.5	Duty cycle	: Cont.(S1)
Rated torque	: 143 ft.lb	Insulation class	: F
Locked rotor torque	: 240 %	Service factor	: 1.15
Breakdown torque	: 280 %	Temperature rise	: 80 K
Rated speed	: 735 rpm	Design	: B

Heating constant

Cooling constant

Rev.	Changes Summary	Performed	Checked	Date
Performed by				
Checked by			Page	Revision
Date	14/04/2022		22 / 36	

THERMAL LIMIT CURVE

Three Phase Induction Motor - Squirrel Cage



Customer : _____

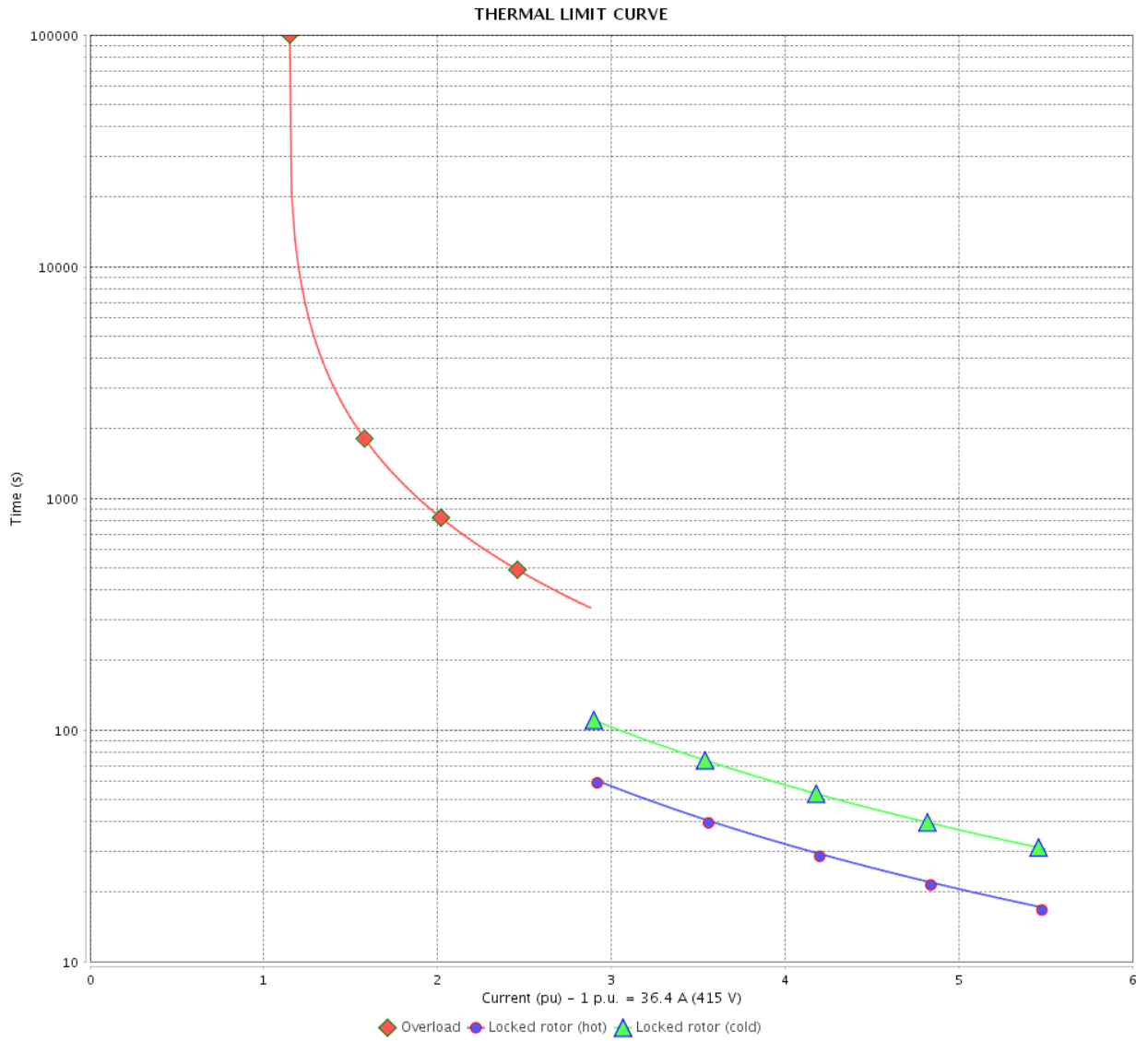

Rev.	Changes Summary	Performed	Checked	Date
Performed by				
Checked by				
Date				
			Page	Revision
			23 / 36	

THERMAL LIMIT CURVE

Three Phase Induction Motor - Squirrel Cage



Customer :

Product line : NEMA Premium Efficiency Three-Phase

Product code : 11584354

Catalog # : 02509ST3QIE326T-W22

Performance : 380 V 50 Hz 8P IE1

Rated current	: 42.3 A	Moment of inertia (J)	: 11.9 sq.ft.lb
LRC	: 4.2	Duty cycle	: Cont.(S1)
Rated torque	: 181 ft.lb	Insulation class	: F
Locked rotor torque	: 150 %	Service factor	: 1.15
Breakdown torque	: 180 %	Temperature rise	: 105 K
Rated speed	: 725 rpm	Design	: B

Heating constant

Cooling constant

Rev.	Changes Summary	Performed	Checked	Date
Performed by				
Checked by			Page	Revision
Date	14/04/2022		24 / 36	

THERMAL LIMIT CURVE

Three Phase Induction Motor - Squirrel Cage



Customer : _____

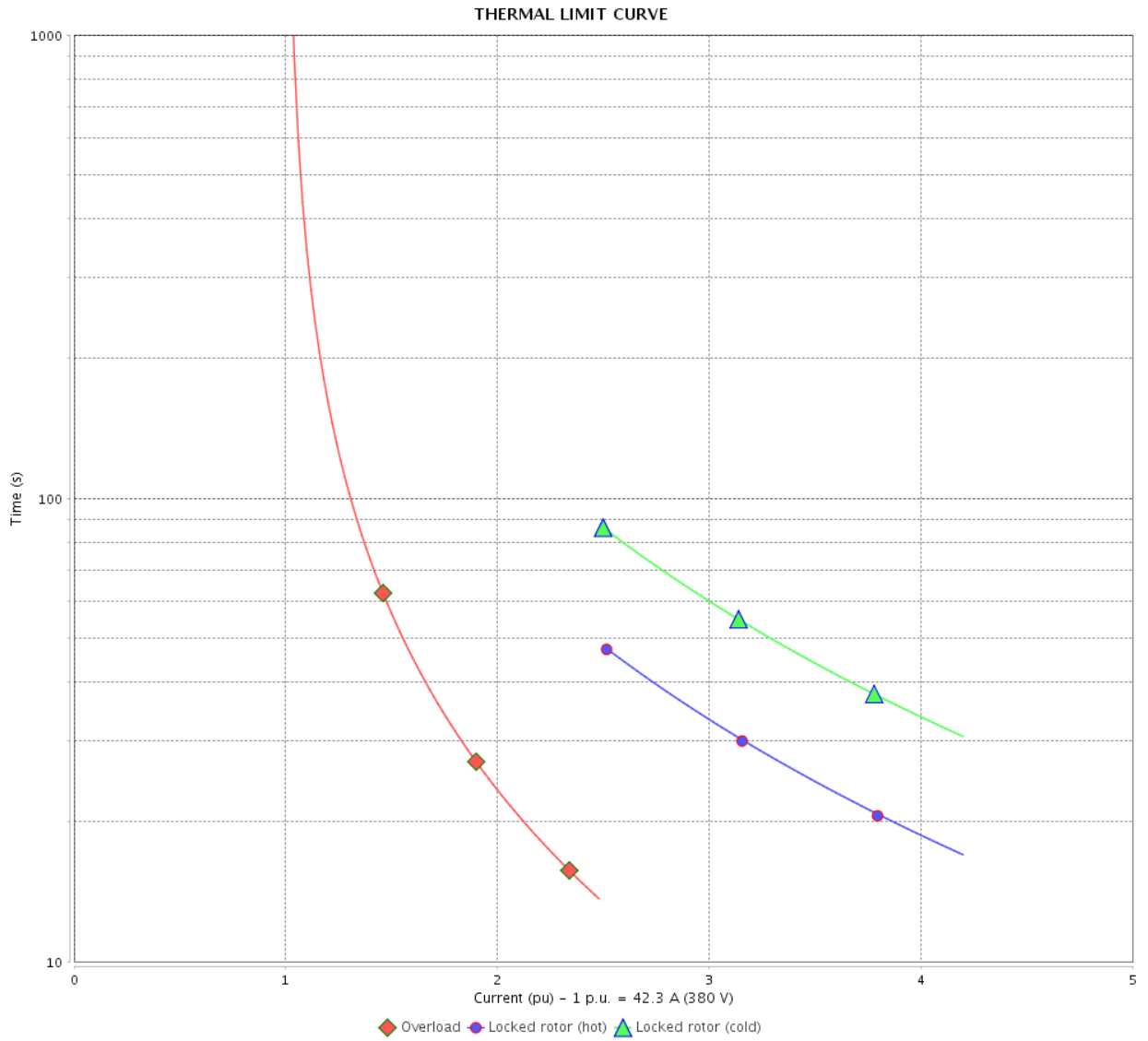

Rev.	Changes Summary	Performed	Checked	Date
Performed by		Page 25 / 36		Revision
Checked by				
Date				

THERMAL LIMIT CURVE



Three Phase Induction Motor - Squirrel Cage

Customer :

Product line : NEMA Premium Efficiency Three-Phase

Product code : 11584354

Catalog # : 02509ST3QIE326T-W22

Performance : 400 V 50 Hz 8P IE2

Rated current	: 41.4 A	Moment of inertia (J)	: 11.9 sq.ft.lb
LRC	: 4.6	Duty cycle	: Cont.(S1)
Rated torque	: 181 ft.lb	Insulation class	: F
Locked rotor torque	: 170 %	Service factor	: 1.15
Breakdown torque	: 200 %	Temperature rise	: 80 K
Rated speed	: 725 rpm	Design	: B

Heating constant

Cooling constant

Rev.	Changes Summary	Performed	Checked	Date
Performed by				
Checked by			Page	Revision
Date	14/04/2022		26 / 36	

THERMAL LIMIT CURVE

Three Phase Induction Motor - Squirrel Cage



Customer : _____

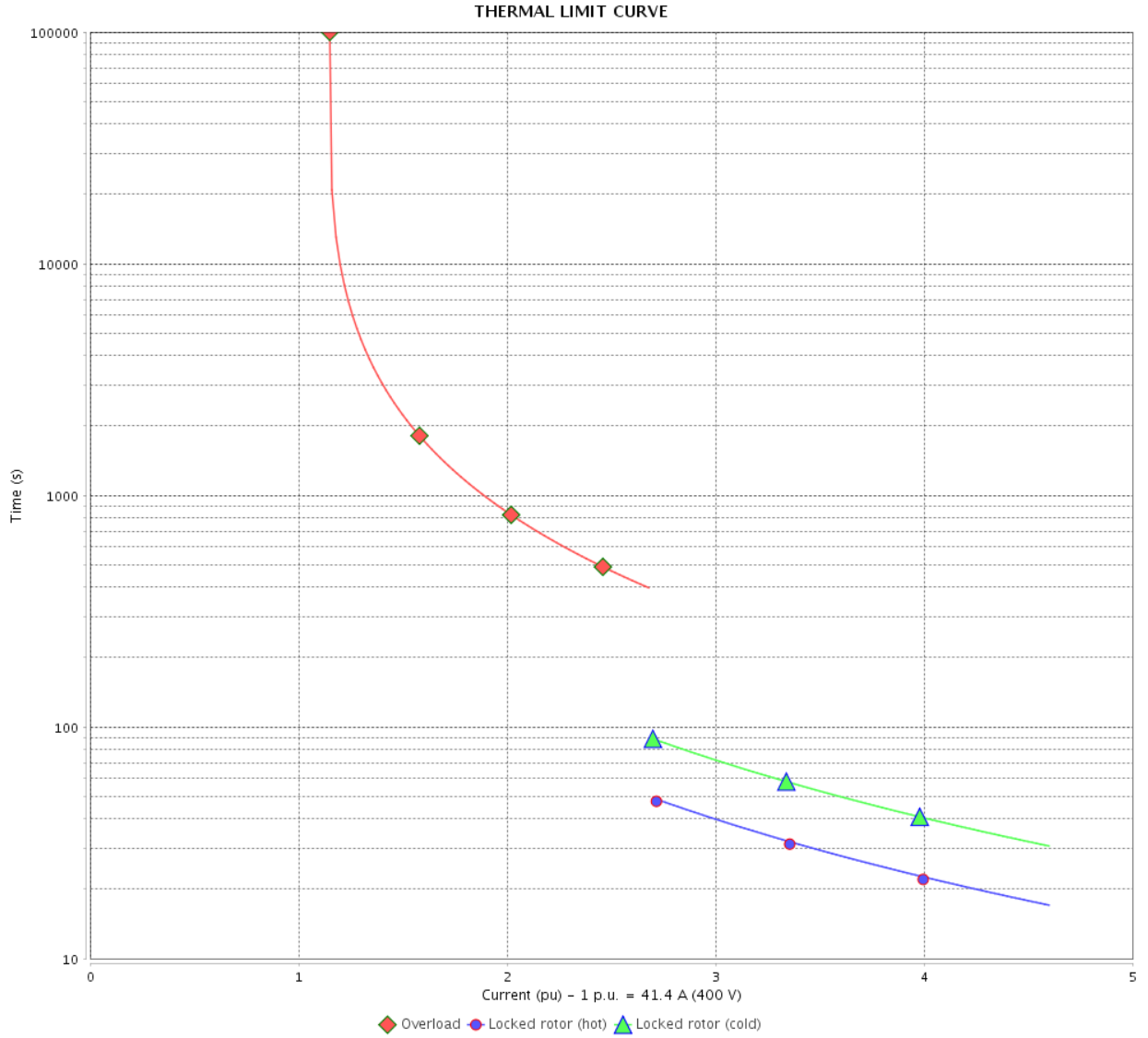

Rev.	Changes Summary	Performed	Checked	Date
Performed by		Page		Revision
Checked by		27 / 36		
Date		14/04/2022		

THERMAL LIMIT CURVE

Three Phase Induction Motor - Squirrel Cage



Customer :

Product line : NEMA Premium Efficiency Three-Phase
Product code : 11584354
Catalog # : 02509ST3QIE326T-W22

Performance : 415 V 50 Hz 8P IE2

Rated current	: 41.1 A	Moment of inertia (J)	: 11.9 sq.ft.lb
LRC	: 4.8	Duty cycle	: Cont.(S1)
Rated torque	: 180 ft.lb	Insulation class	: F
Locked rotor torque	: 190 %	Service factor	: 1.15
Breakdown torque	: 220 %	Temperature rise	: 80 K
Rated speed	: 730 rpm	Design	: B

Heating constant

Cooling constant

Rev.	Changes Summary	Performed	Checked	Date
Performed by				
Checked by			Page	Revision
Date	14/04/2022		28 / 36	

THERMAL LIMIT CURVE

Three Phase Induction Motor - Squirrel Cage



Customer : _____

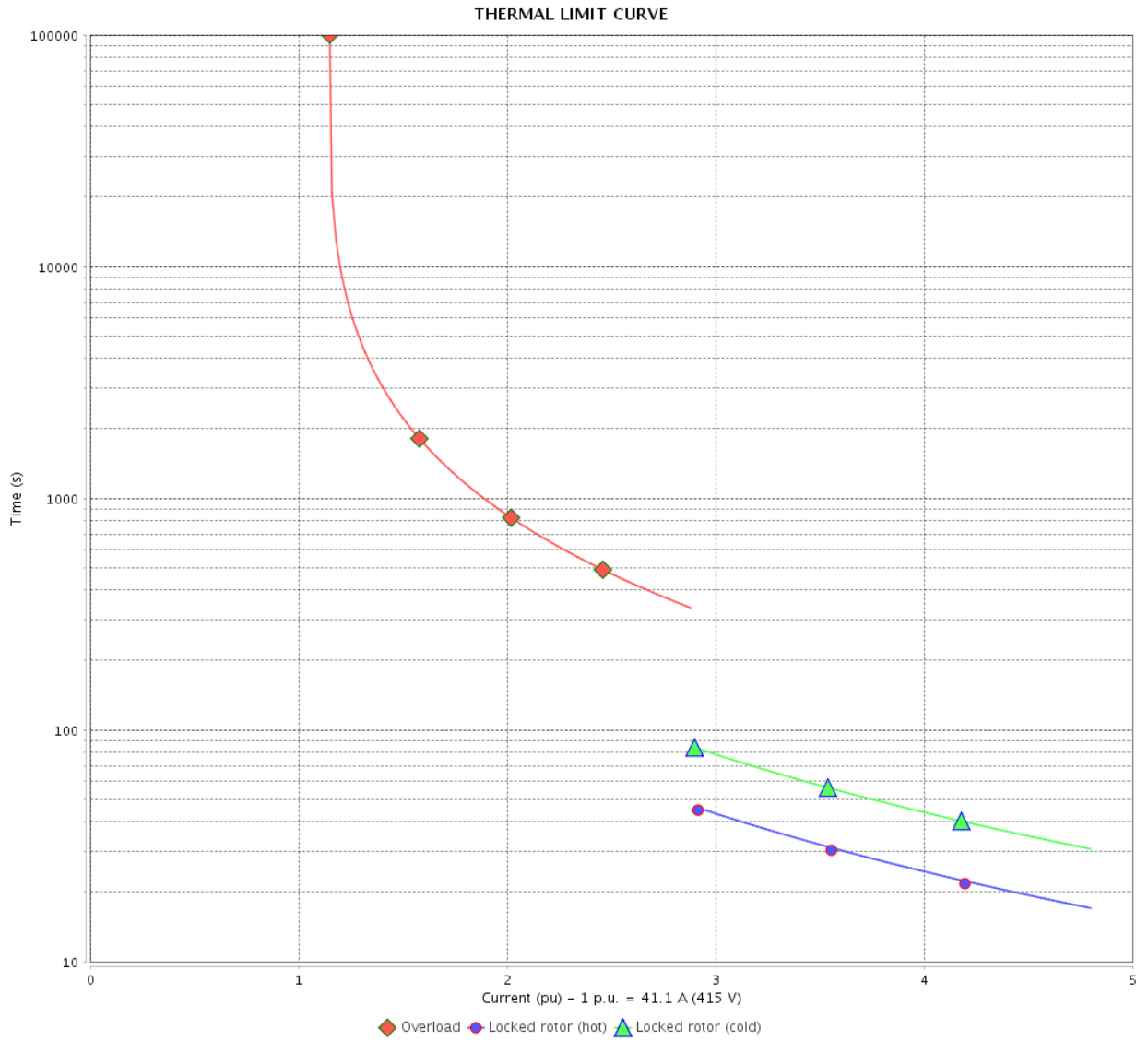

Rev.	Changes Summary	Performed	Checked	Date
Performed by		Page 29 / 36		Revision
Checked by				
Date				

VFD OPERATION CURVE

Three Phase Induction Motor - Squirrel Cage



Customer : _____

Product line : NEMA Premium Efficiency Three-Phase

Product code : 11584354

Catalog # : 02509ST3QIE326T-W22

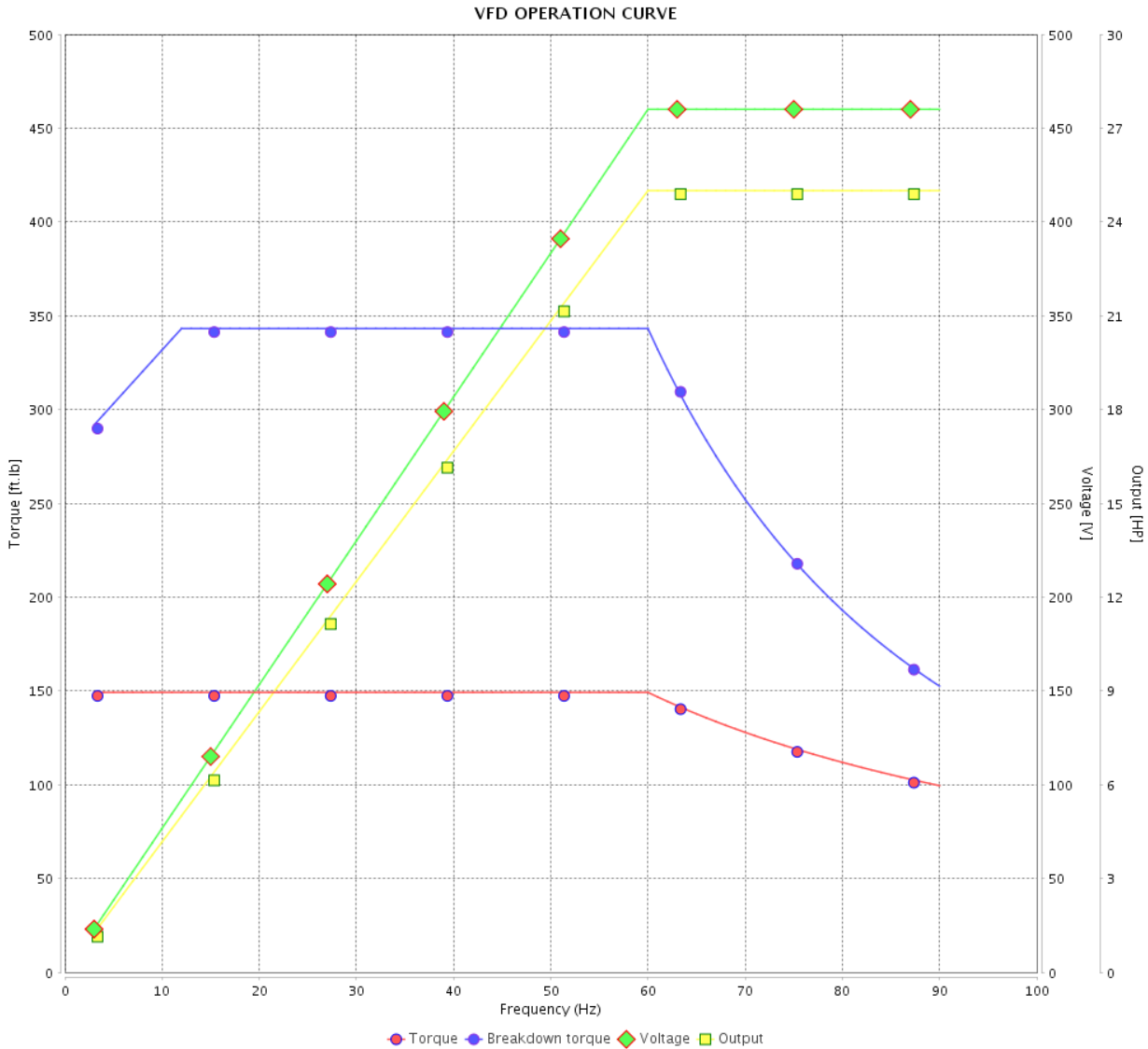

Performance : 460 V 60 Hz 8P

Rated current : 35.9 A
 LRC : 5.2
 Rated torque : 149 ft.lb
 Locked rotor torque : 200 %
 Breakdown torque : 229 %
 Rated speed : 880 rpm

Moment of inertia (J) : 11.9 sq.ft.lb
 Duty cycle : Cont.(S1)
 Insulation class : F
 Service factor : 1.25
 Temperature rise : 80 K
 Design : B

Rev.	Changes Summary	Performed	Checked	Date
Performed by			Page	Revision
Checked by				
Date				

VFD OPERATION CURVE

Three Phase Induction Motor - Squirrel Cage



Customer : _____

Product line : NEMA Premium Efficiency Three-Phase

Product code : 11584354

Catalog # : 02509ST3QIE326T-W22

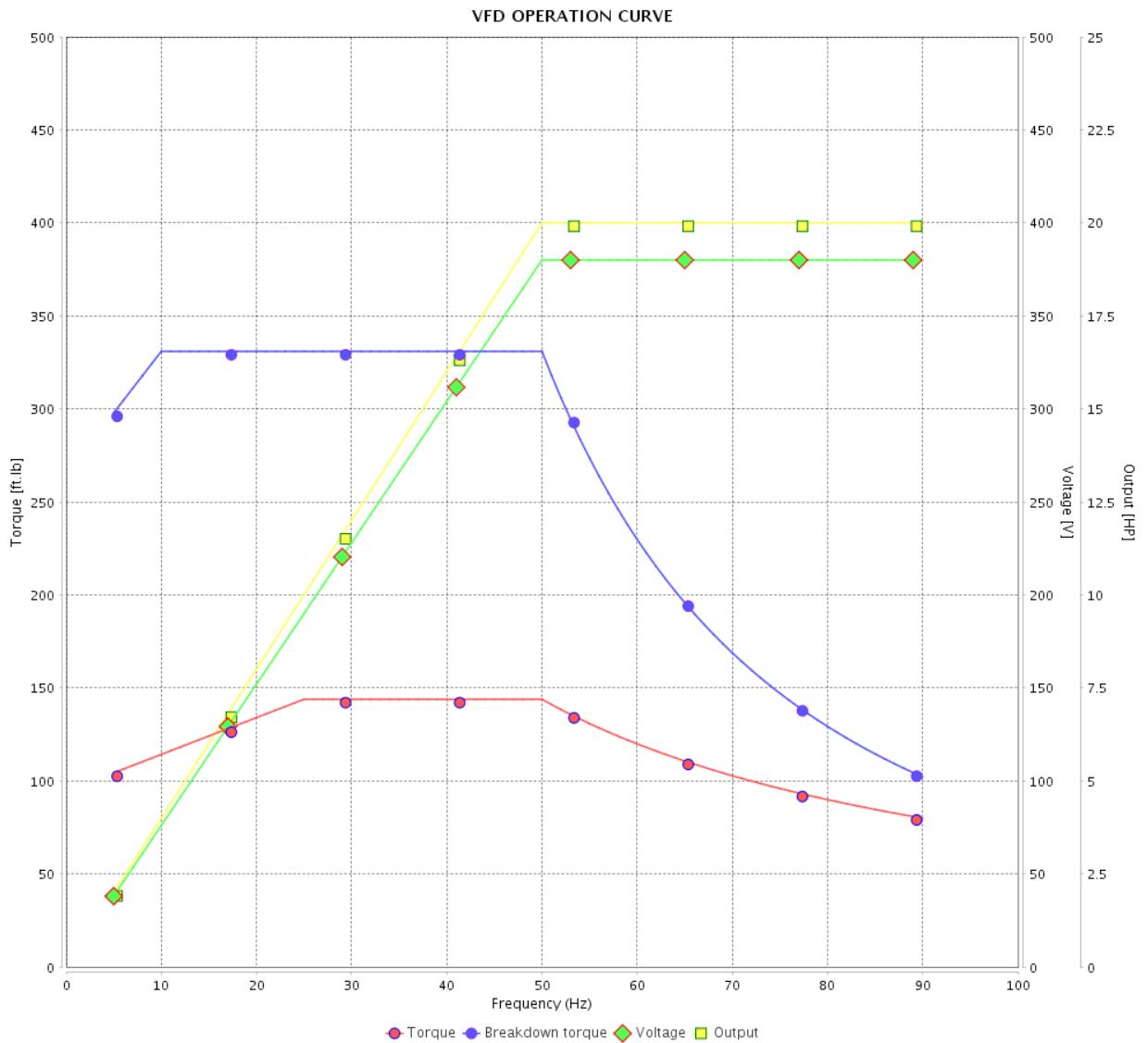

Performance : 380 V 50 Hz 8P IE3

Rated current : 35.3 A
 LRC : 5.0
 Rated torque : 144 ft.lb
 Locked rotor torque : 190 %
 Breakdown torque : 229 %
 Rated speed : 730 rpm

Moment of inertia (J) : 11.9 sq.ft.lb
 Duty cycle : Cont.(S1)
 Insulation class : F
 Service factor : 1.15
 Temperature rise : 80 K
 Design : B

Rev.	Changes Summary	Performed	Checked	Date
Performed by		Page		Revision
Checked by		31 / 36		
Date	14/04/2022			

VFD OPERATION CURVE

Three Phase Induction Motor - Squirrel Cage



Customer : _____

Product line : NEMA Premium Efficiency Three-Phase

Product code : 11584354

Catalog # : 02509ST3QIE326T-W22

VFD OPERATION CURVE

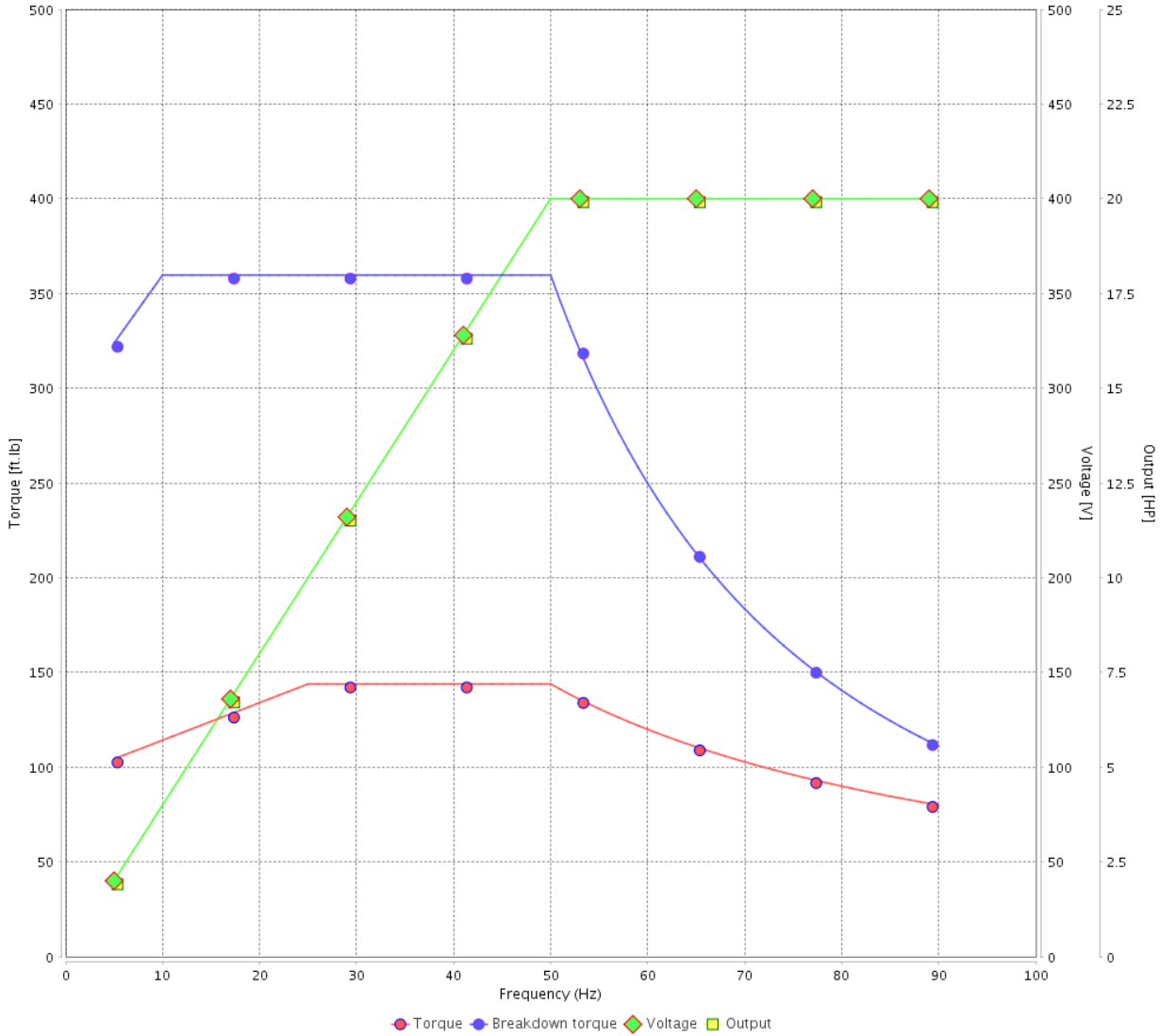

Performance : 400 V 50 Hz 8P IE3

Rated current : 35.6 A
 LRC : 5.4
 Rated torque : 144 ft.lb
 Locked rotor torque : 210 %
 Breakdown torque : 250 %
 Rated speed : 730 rpm

Moment of inertia (J) : 11.9 sq.ft.lb
 Duty cycle : Cont.(S1)
 Insulation class : F
 Service factor : 1.15
 Temperature rise : 80 K
 Design : B

Rev.	Changes Summary	Performed	Checked	Date
Performed by			Page 32 / 36	Revision
Checked by				
Date	14/04/2022			

VFD OPERATION CURVE

Three Phase Induction Motor - Squirrel Cage



Customer : _____

Product line : NEMA Premium Efficiency Three-Phase

Product code : 11584354

Catalog # : 02509ST3QIE326T-W22

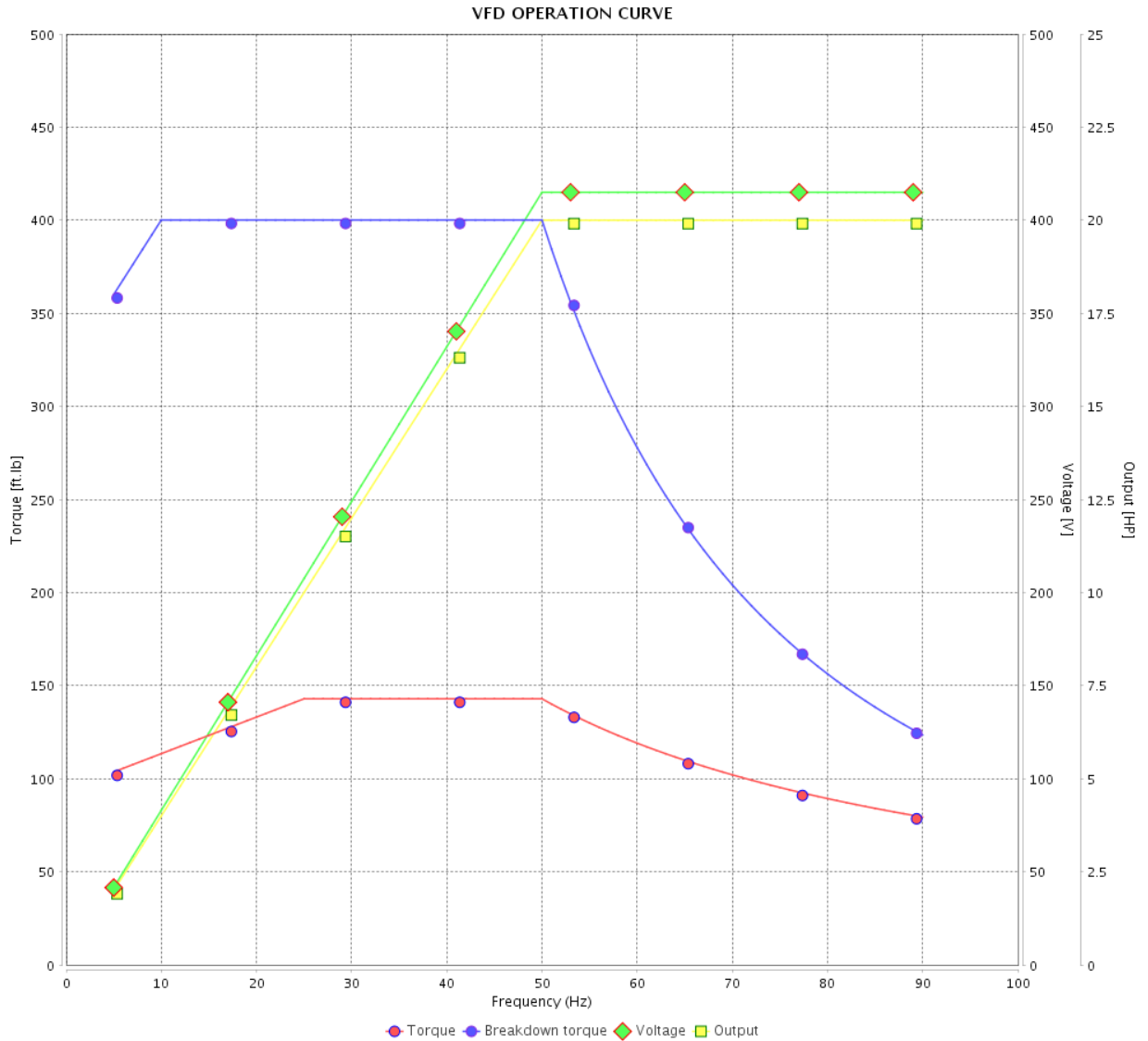

Performance : 415 V 50 Hz 8P IE3

Rated current : 36.4 A
 LRC : 5.5
 Rated torque : 143 ft.lb
 Locked rotor torque : 240 %
 Breakdown torque : 280 %
 Rated speed : 735 rpm

Moment of inertia (J) : 11.9 sq.ft.lb
 Duty cycle : Cont.(S1)
 Insulation class : F
 Service factor : 1.15
 Temperature rise : 80 K
 Design : B

Rev.	Changes Summary	Performed	Checked	Date
Performed by		Page		Revision
Checked by		33 / 36		
Date		14/04/2022		

VFD OPERATION CURVE

Three Phase Induction Motor - Squirrel Cage



Customer :

Product line : NEMA Premium Efficiency Three-Phase

Product code : 11584354

Catalog # : 02509ST3QIE326T-W22

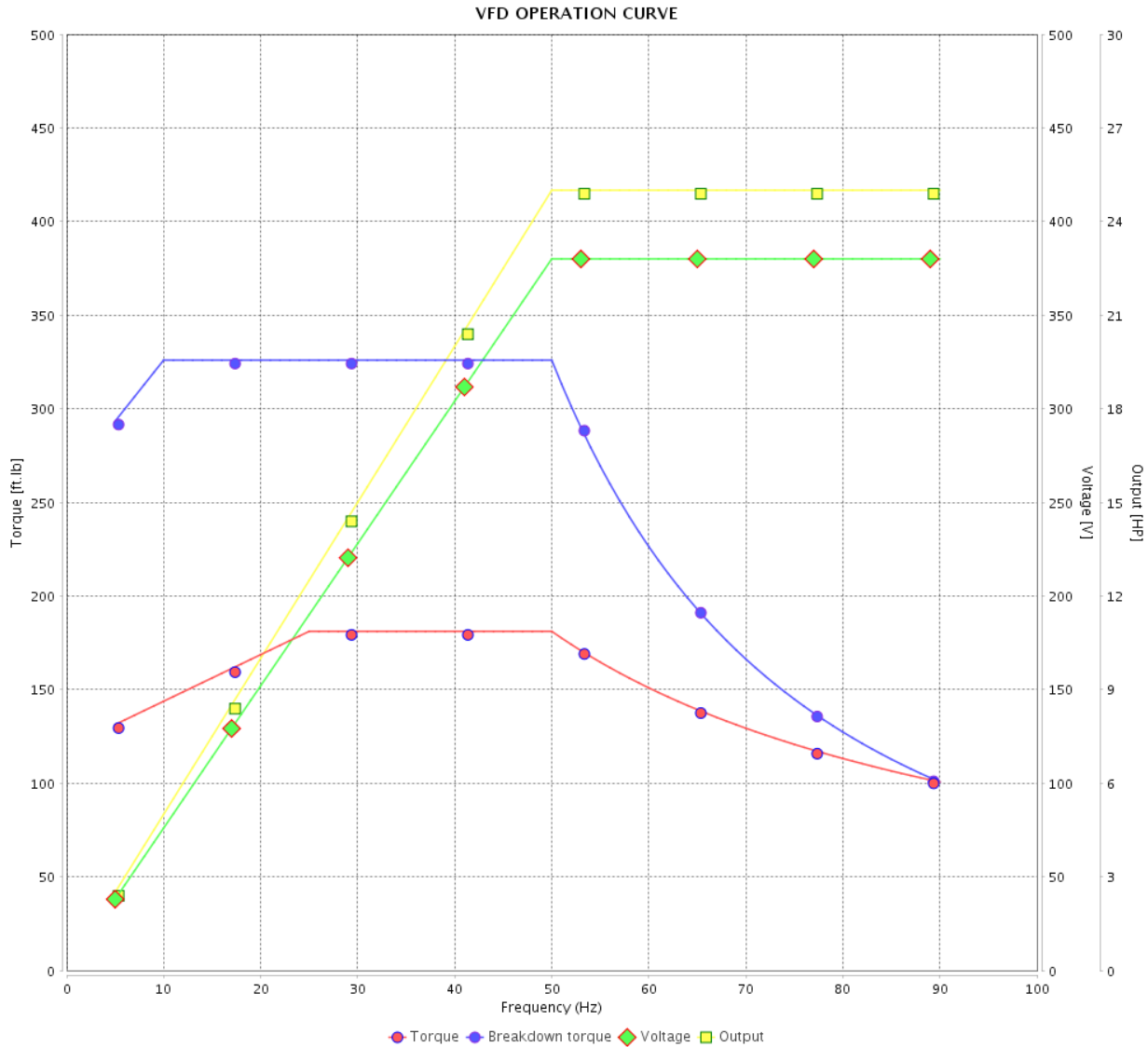

Performance : 380 V 50 Hz 8P IE1

Rated current	: 42.3 A	Moment of inertia (J)	: 11.9 sq.ft.lb
LRC	: 4.2	Duty cycle	: Cont.(S1)
Rated torque	: 181 ft.lb	Insulation class	: F
Locked rotor torque	: 150 %	Service factor	: 1.15
Breakdown torque	: 180 %	Temperature rise	: 105 K
Rated speed	: 725 rpm	Design	: B

Rev.	Changes Summary	Performed	Checked	Date
Performed by			Page 34 / 36	Revision
Checked by				
Date	14/04/2022			

VFD OPERATION CURVE

Three Phase Induction Motor - Squirrel Cage



Customer :

Product line : NEMA Premium Efficiency Three-Phase

Product code : 11584354

Catalog # : 02509ST3QIE326T-W22

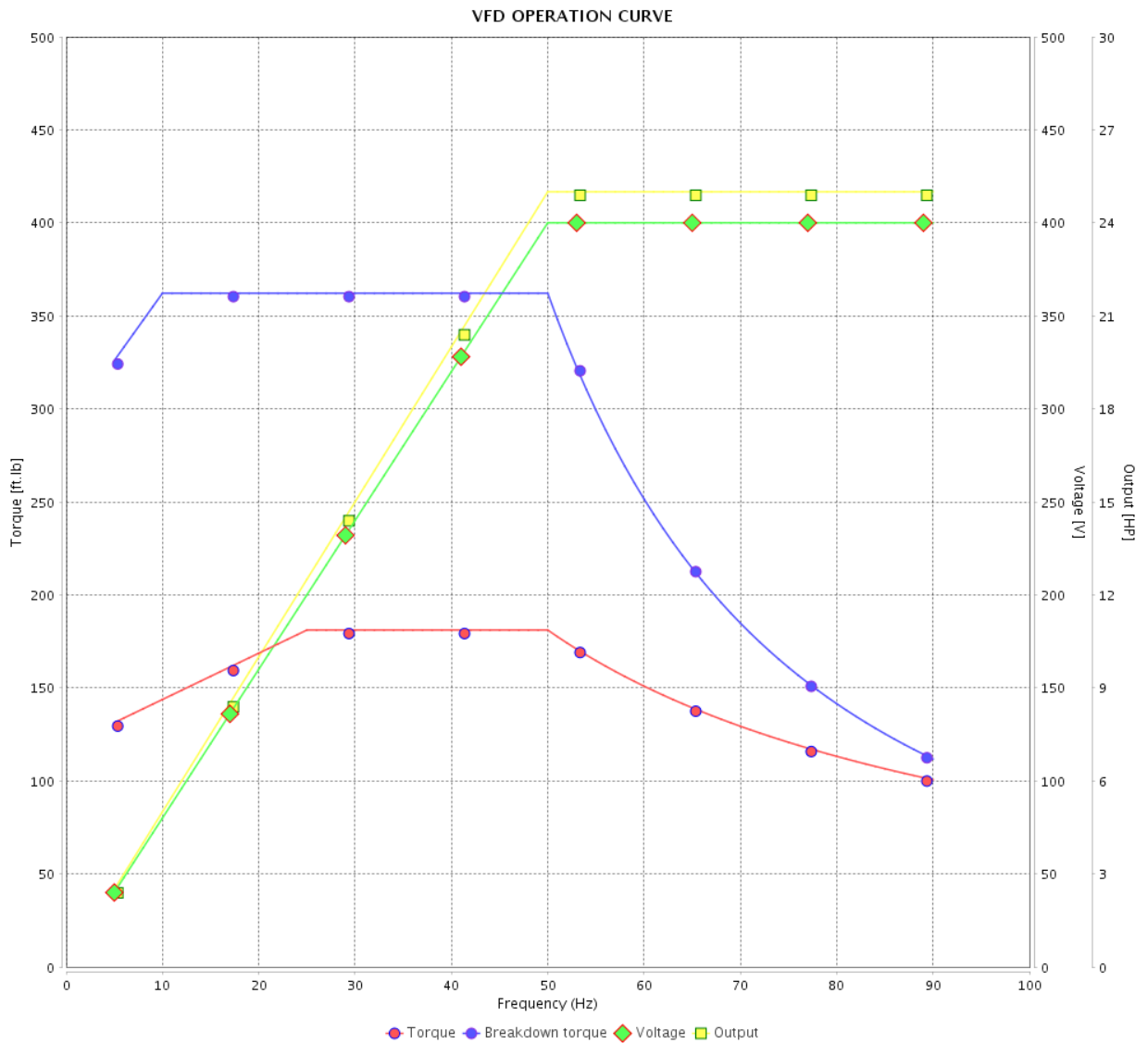

Performance : 400 V 50 Hz 8P IE2

Rated current : 41.4 A
 LRC : 4.6
 Rated torque : 181 ft.lb
 Locked rotor torque : 170 %
 Breakdown torque : 200 %
 Rated speed : 725 rpm

Moment of inertia (J) : 11.9 sq.ft.lb
 Duty cycle : Cont.(S1)
 Insulation class : F
 Service factor : 1.15
 Temperature rise : 80 K
 Design : B

Rev.	Changes Summary	Performed	Checked	Date
Performed by		Page		Revision
Checked by		35 / 36		
Date		14/04/2022		

VFD OPERATION CURVE

Three Phase Induction Motor - Squirrel Cage



Customer :

Product line : NEMA Premium Efficiency Three-Phase

Product code : 11584354

Catalog # : 02509ST3QIE326T-W22

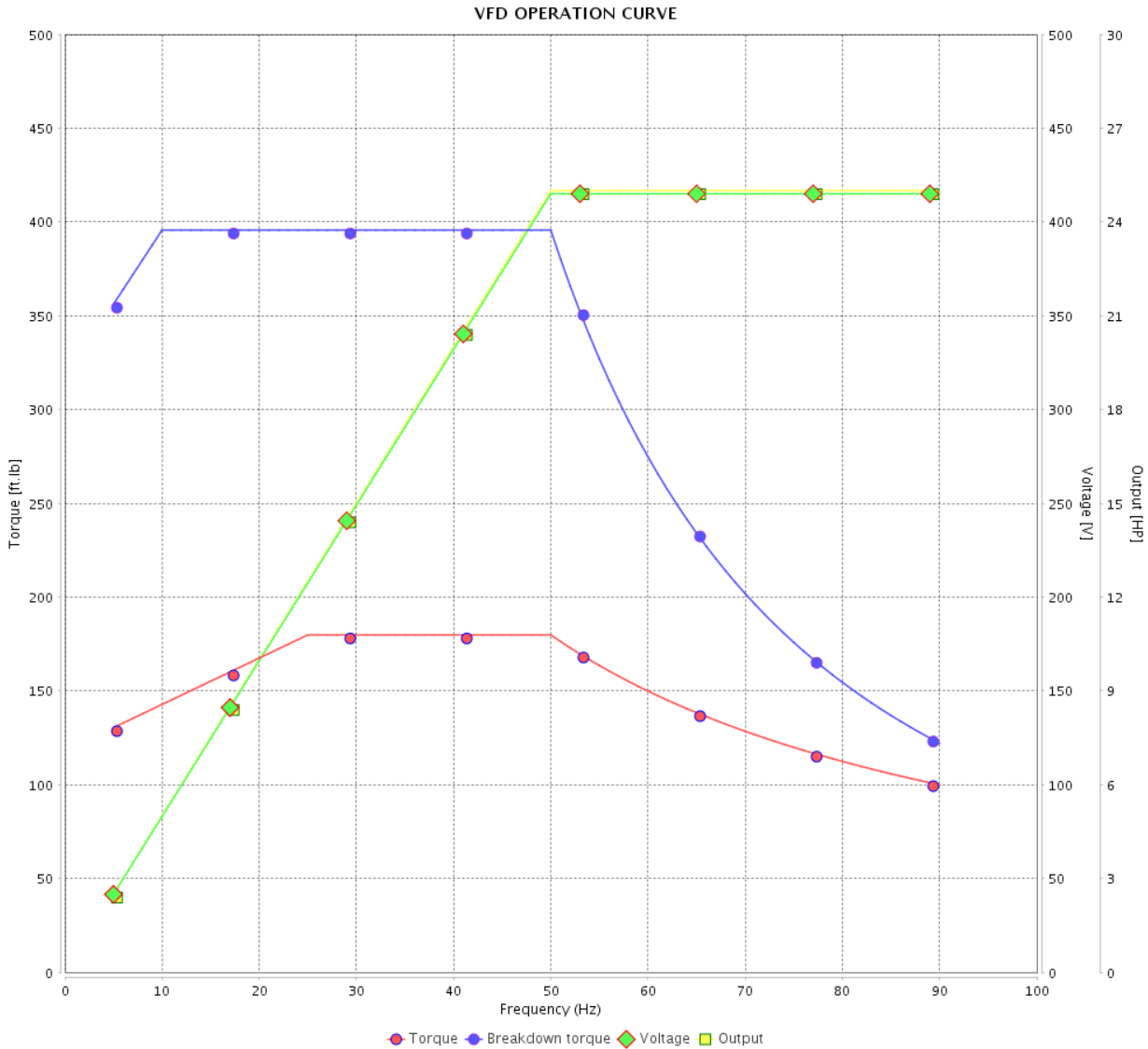

Performance : 415 V 50 Hz 8P IE2

Rated current	: 41.1 A	Moment of inertia (J)	: 11.9 sq.ft.lb
LRC	: 4.8	Duty cycle	: Cont.(S1)
Rated torque	: 180 ft.lb	Insulation class	: F
Locked rotor torque	: 190 %	Service factor	: 1.15
Breakdown torque	: 220 %	Temperature rise	: 80 K
Rated speed	: 730 rpm	Design	: B

Rev.	Changes Summary	Performed	Checked	Date
Performed by			Page 36 / 36	Revision
Checked by				
Date	14/04/2022			

1 2 3 4 5 6

A

B

C

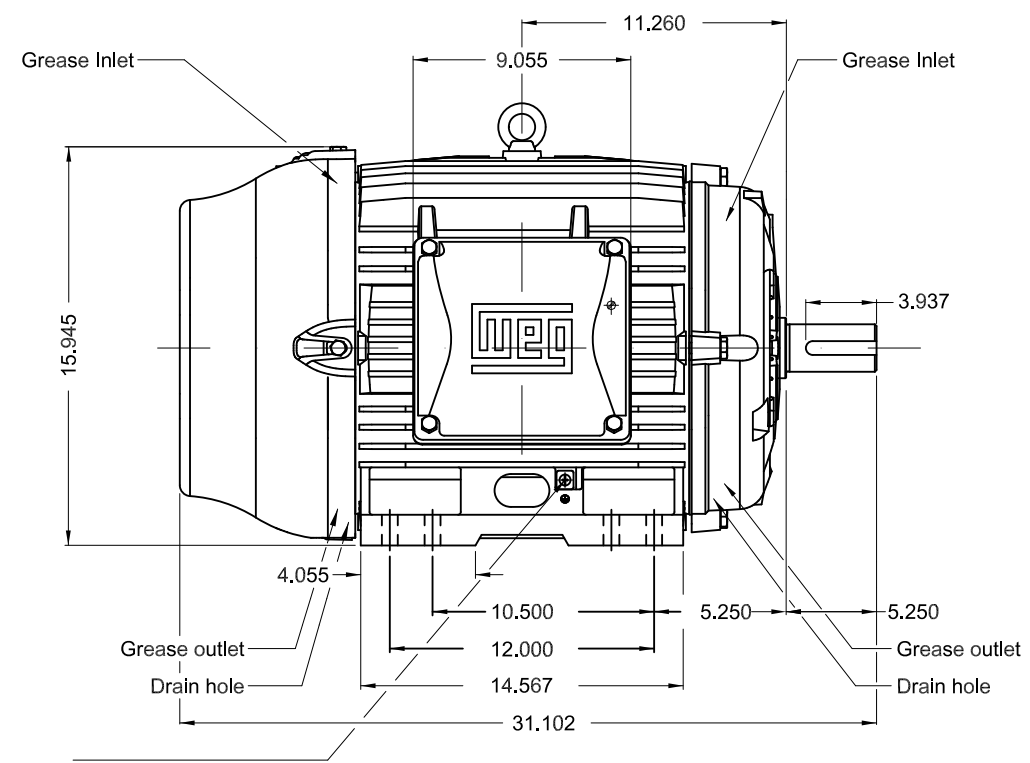
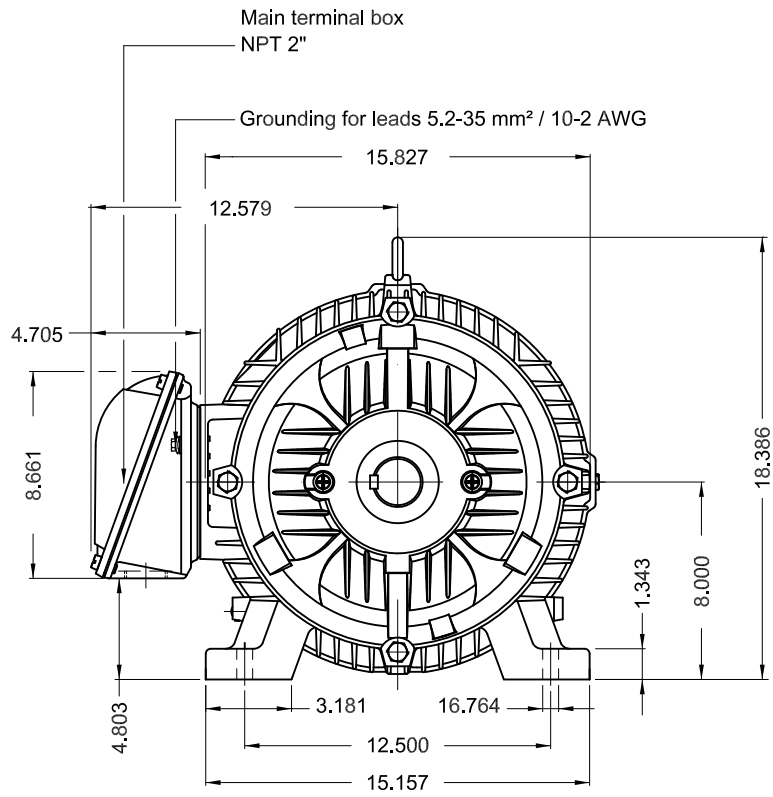

Grounding for leads 5.2-35 mm² / 10-2 AWG

D

E

Color RAL 5009
Painting plan 202E
Mounting B3R(D)

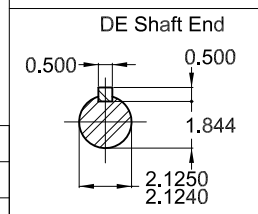

25 HP 08 Poles 60 Hz A

ECM	LOC	SUMMARY OF MODIFICATIONS	EXECUTED	CHECKED	RELEASED	DATE	VER
EXECUTED	PIRWBUSER	THREE PH. MOTOR IEEE 841 W22 PREM. EFF.					
CHECKED		FRAME 324/6T IP55 TEFC					
RELEASED							
REL DT.	WMO	Jaragua do Sul	Product Engineering	SHEET	1 / 1		

PREVIEW
WDD





NEMA
Premium
W22



FOR SAFE AREA
Mod.TE1BFOXON
CC029A



Class I, Div 2, Gr A, B, C and D - T3
Class I, Zone 2, IIC - T3
Class II, Div 2, Gr F and G - T4
For use on PWM: Gr. A, B, C, D and F,
VT 1000:1, CT 20:1, 1.00SF - T3A

MODEL 02509ST3QIE326T-W22



Inverter Duty Motor
Severe Duty

MADE IN BRAZIL
11584354

PH3 60Hz Fr. 324/6T 1000m.a.s.l. IP55 TEFC 562lb

V 460

A 35.9

HP 25

kW 18.5

SF 1.25

SFA 44.9

RPM 880

PF 0.71

AMB 40°C

INS cl. F DT80K

NEMA NOM EFF 91.0%



DUTY CONT.

DES B Code G

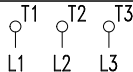
GUARANT. EFF 89.5%



460V

-  → 6312-C3 (21g) 60BC03X30
-  → 6212-C3 (13g) 60BC02X30



MOBIL POLYREX EM (20000h)

