

DATA SHEET

Three Phase Induction Motor - Squirrel Cage



Customer							
Product line	: NEMA Premium Efficiency Three-Phase	Product code	: 12447067				
		Catalog #	: 02518ET3E284TC-W22				
Frame	: 284/6TC	Cooling method	: IC411 - TEFC				
Insulation class	: F	Mounting	: F-1				
Duty cycle	: Cont.(S1)	Rotation ¹	: Both (CW and CCW)				
Ambient temperature	: -20°C to +40°C	Starting method	: Direct On Line				
Altitude	: 1000 m.a.s.l.	Approx. weight ²	: 440 lb				
Protection degree	: IP55	Moment of inertia (J)	: 5.11 sq.ft.lb				
Design	: B						
Output [HP]	25	20	20	20	25	25	25
Poles	4	4	4	4	4	4	4
Frequency [Hz]	60	50	50	50	50	50	50
Rated voltage [V]	230/460	380	400	415	380	400	415
Rated current [A]	59.0/29.5	29.1	28.2	27.5	35.6	34.0	33.2
L. R. Amperes [A]	366/183	175	189	198	174	187	196
LRC [A]	6.2x(Code G)	6.0x(Code G)	6.7x(Code H)	7.2x(Code J)	4.9x(Code E)	5.5x(Code F)	5.9x(Code G)
No load current [A]	21.0/10.5	10.4	11.1	11.6	10.4	11.1	11.6
Rated speed [RPM]	1765	1465	1470	1470	1445	1455	1460
Slip [%]	1.94	2.33	2.00	2.00	3.67	3.00	2.67
Rated torque [ft.lb]	74.4	71.7	71.4	71.4	90.9	90.2	89.9
Locked rotor torque [%]	240	229	260	290	180	210	229
Breakdown torque [%]	270	260	300	330	210	240	260
Service factor	1.25	1.00	1.00	1.00	1.00	1.00	1.00
Temperature rise	80 K	80 K	80 K	80 K	105 K	105 K	80 K
Locked rotor time	43s (cold) 24s (hot)	32s (cold) 18s (hot)	32s (cold) 18s (hot)	32s (cold) 18s (hot)	32s (cold) 18s (hot)	32s (cold) 18s (hot)	32s (cold) 18s (hot)
Noise level ²	63.0 dB(A)	61.0 dB(A)	61.0 dB(A)	61.0 dB(A)	61.0 dB(A)	61.0 dB(A)	61.0 dB(A)
Efficiency (%)	25%						
	50%	92.4	91.3	91.3	91.2	92.4	92.4
	75%	93.0	92.1	92.5	92.5	91.7	92.4
	100%	93.6	92.1	92.6	92.7	91.7	92.4
Power Factor	25%						
	50%	0.70	0.69	0.65	0.62	0.76	0.73
	75%	0.80	0.80	0.78	0.75	0.84	0.82
	100%	0.84	0.85	0.83	0.82	0.86	0.85
Bearing type	: Drive end 6311 C3	Non drive end 6211 C3	Foundation loads				
Sealing	: V'Ring	V'Ring	Max. traction : 800 lb				
Lubrication interval	: 20000 h	20000 h	Max. compression : 1239 lb				
Lubricant amount	: 18 g	11 g					
Lubricant type	: Mobil Polyrex EM						
Notes							
USABLE @208V 65.2A SF 1.15 SFA 75.0A							
This revision replaces and cancel the previous one, which must be eliminated. (1) Looking the motor from the shaft end. (2) Measured at 1m and with tolerance of +3dB(A). (3) Approximate weight subject to changes after manufacturing process. (4) At 100% of full load.				These are average values based on tests with sinusoidal power supply, subject to the tolerances stipulated in NEMA MG-1.			
Rev.	Changes Summary			Performed	Checked	Date	
Performed by							
Checked by					Page	Revision	
Date	14/04/2022				1 / 36		

TORQUE AND CURRENT VS SPEED CURVE

Three Phase Induction Motor - Squirrel Cage



Customer :

Product line : NEMA Premium Efficiency Three-Phase

Product code : 12447067

Catalog # : 02518ET3E284TC-W22

TORQUE AND CURRENT VS SPEED CURVE

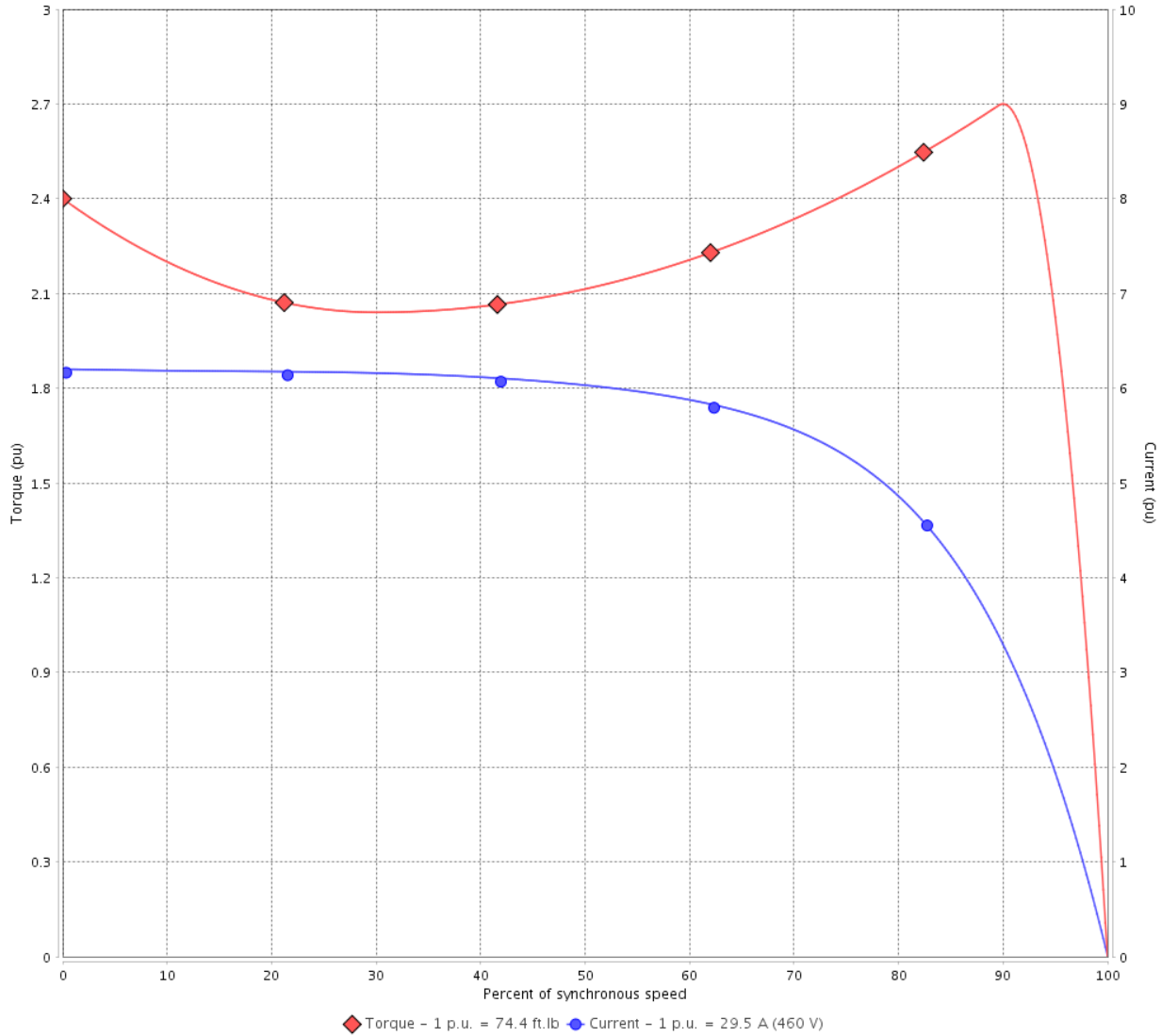

Performance : 230/460 V 60 Hz 4P

Rated current	: 59.0/29.5 A	Moment of inertia (J)	: 5.11 sq.ft.lb
LRC	: 6.2	Duty cycle	: Cont.(S1)
Rated torque	: 74.4 ft.lb	Insulation class	: F
Locked rotor torque	: 240 %	Service factor	: 1.25
Breakdown torque	: 270 %	Temperature rise	: 80 K
Rated speed	: 1765 rpm	Design	: B

Locked rotor time : 43s (cold) 24s (hot)

Rev.	Changes Summary	Performed	Checked	Date
Performed by			Page 2 / 36	Revision
Checked by				
Date	14/04/2022			

TORQUE AND CURRENT VS SPEED CURVE



Three Phase Induction Motor - Squirrel Cage

Customer :

Product line : NEMA Premium Efficiency Three-Phase

Product code : 12447067

Catalog # : 02518ET3E284TC-W22

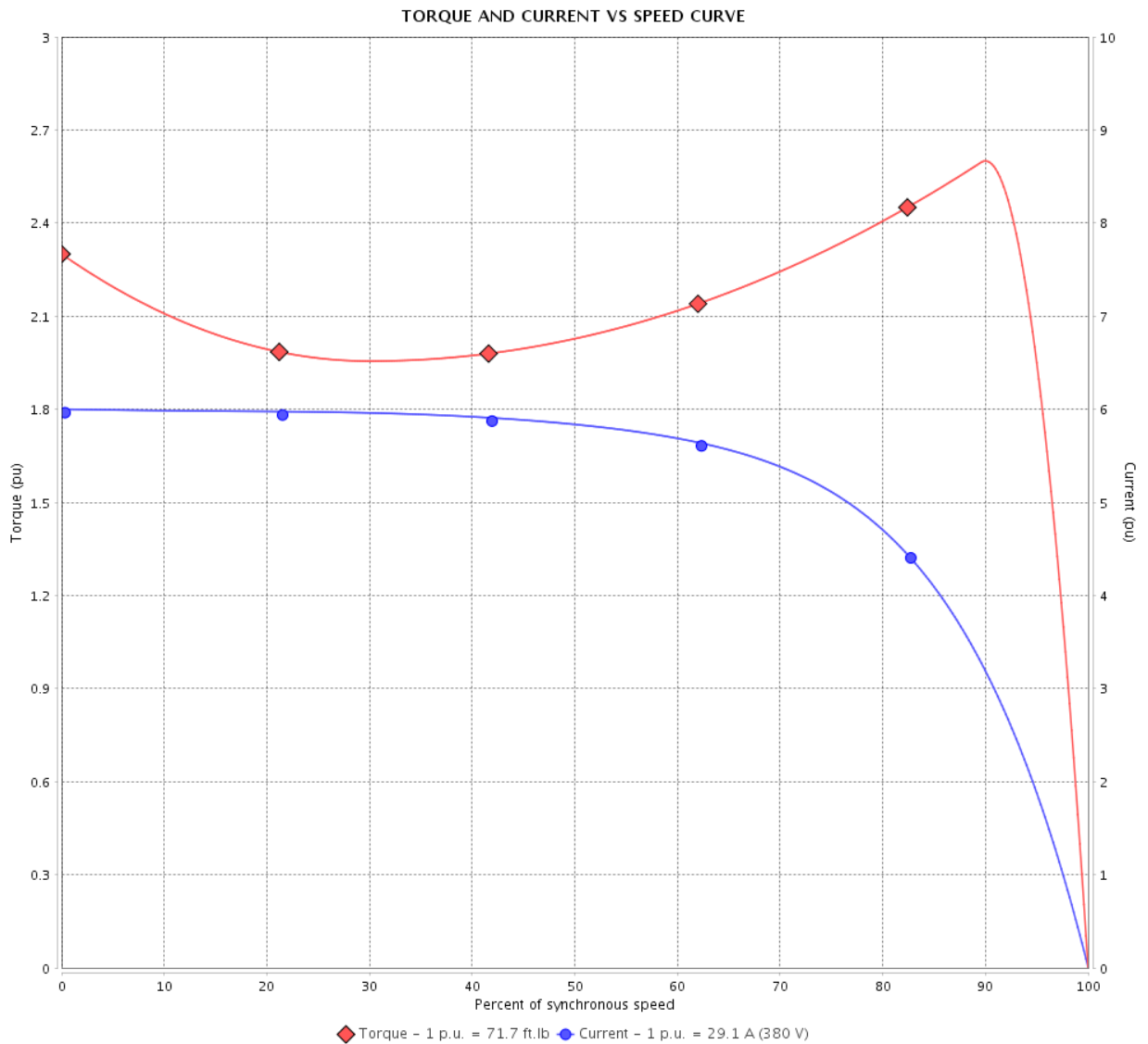

Performance : 380 V 50 Hz 4P IE3

Rated current	: 29.1 A	Moment of inertia (J)	: 5.11 sq.ft.lb
LRC	: 6.0	Duty cycle	: Cont.(S1)
Rated torque	: 71.7 ft.lb	Insulation class	: F
Locked rotor torque	: 229 %	Service factor	: 1.00
Breakdown torque	: 260 %	Temperature rise	: 80 K
Rated speed	: 1465 rpm	Design	: B

Locked rotor time : 32s (cold) 18s (hot)

Rev.	Changes Summary	Performed	Checked	Date
Performed by			Page 3 / 36	Revision
Checked by				
Date	14/04/2022			

TORQUE AND CURRENT VS SPEED CURVE

Three Phase Induction Motor - Squirrel Cage



Customer :

Product line : NEMA Premium Efficiency Three-Phase

Product code : 12447067

Catalog # : 02518ET3E284TC-W22

TORQUE AND CURRENT VS SPEED CURVE

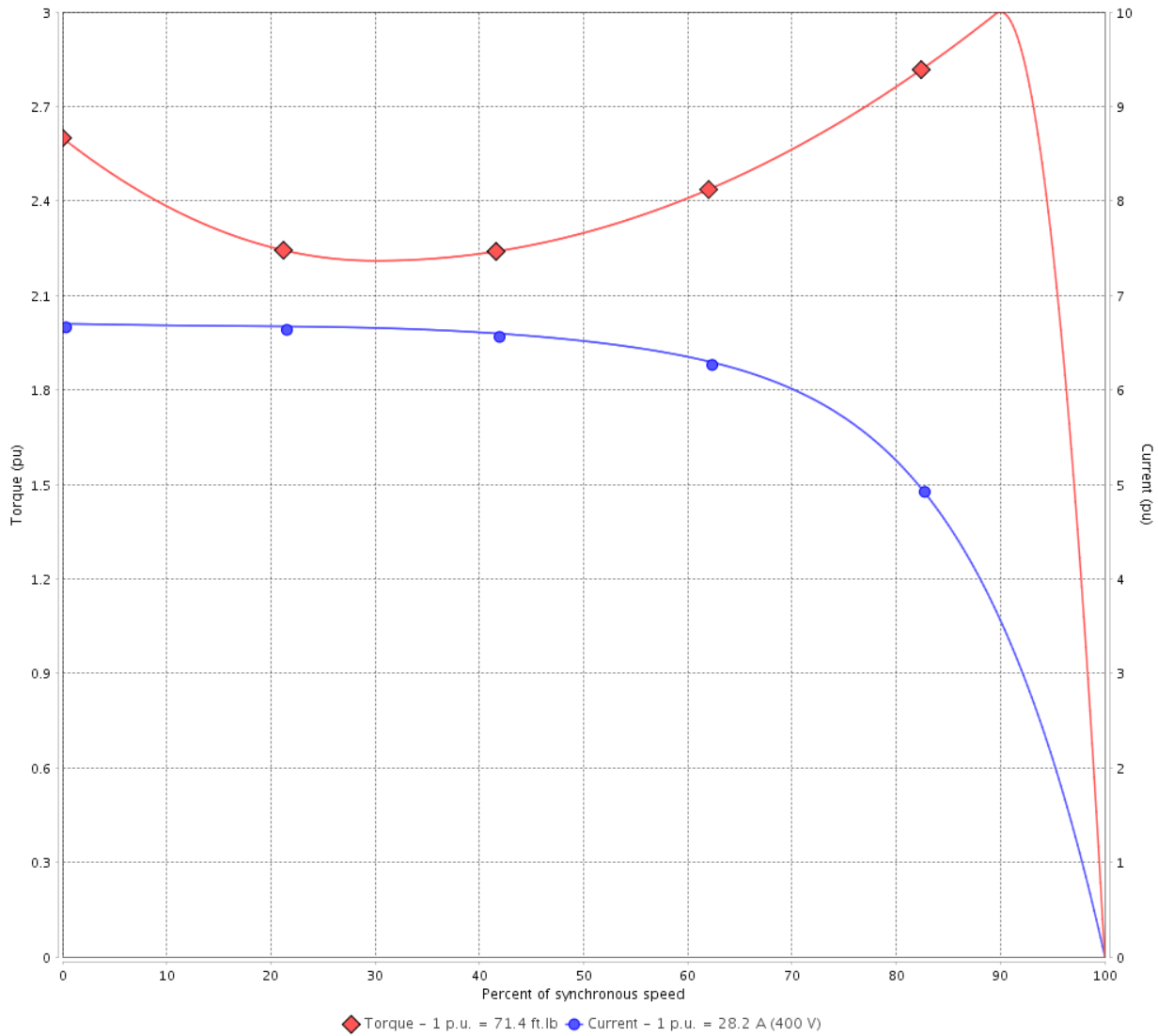

Performance : 400 V 50 Hz 4P IE3

Rated current	: 28.2 A	Moment of inertia (J)	: 5.11 sq.ft.lb
LRC	: 6.7	Duty cycle	: Cont.(S1)
Rated torque	: 71.4 ft.lb	Insulation class	: F
Locked rotor torque	: 260 %	Service factor	: 1.00
Breakdown torque	: 300 %	Temperature rise	: 80 K
Rated speed	: 1470 rpm	Design	: B

Locked rotor time : 32s (cold) 18s (hot)

Rev.	Changes Summary	Performed	Checked	Date
Performed by			Page 4 / 36	Revision
Checked by				
Date	14/04/2022			

TORQUE AND CURRENT VS SPEED CURVE



Three Phase Induction Motor - Squirrel Cage

Customer :

Product line : NEMA Premium Efficiency Three-Phase

Product code : 12447067

Catalog # : 02518ET3E284TC-W22

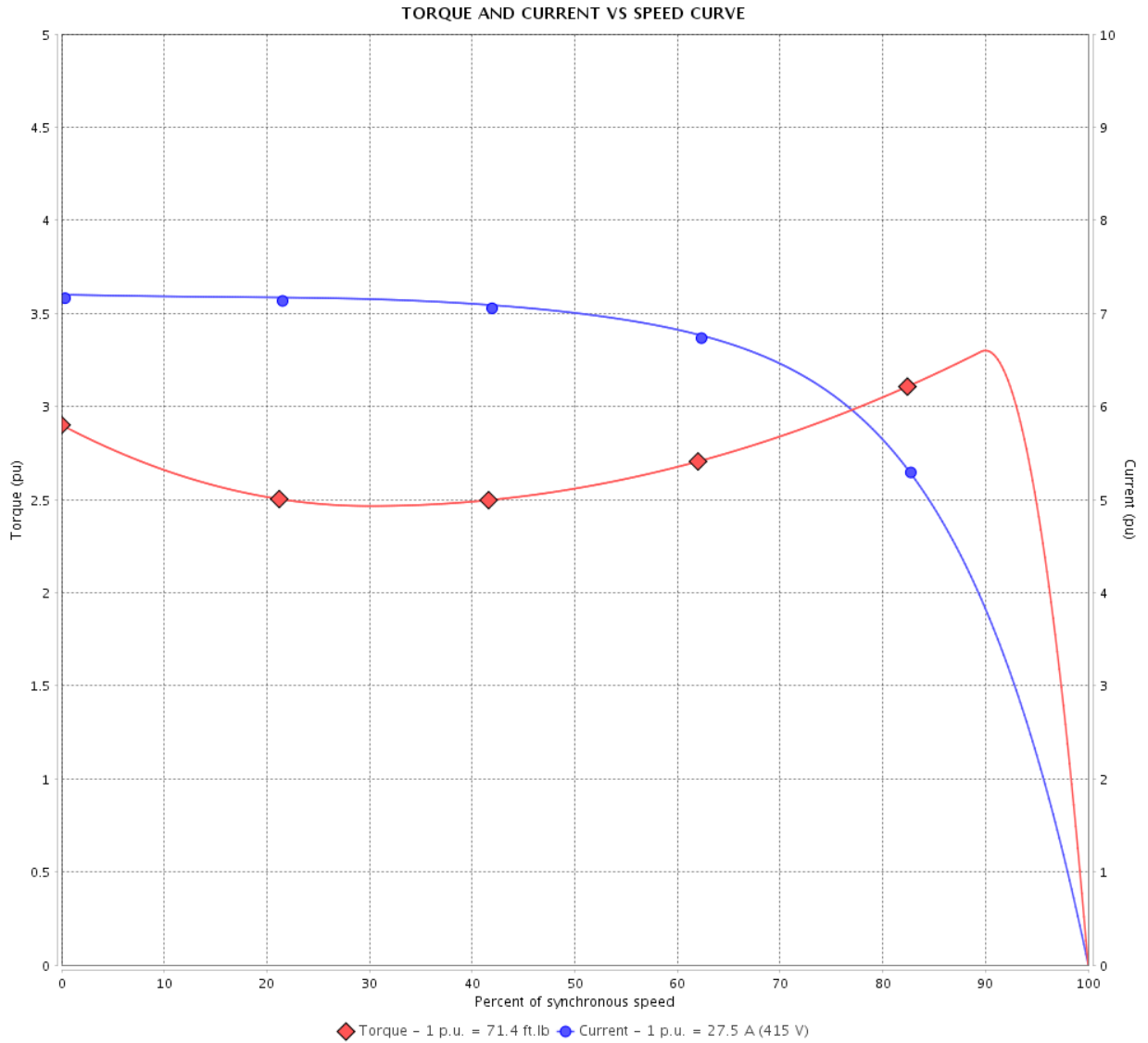

Performance : 415 V 50 Hz 4P IE3

Rated current	: 27.5 A	Moment of inertia (J)	: 5.11 sq.ft.lb
LRC	: 7.2	Duty cycle	: Cont.(S1)
Rated torque	: 71.4 ft.lb	Insulation class	: F
Locked rotor torque	: 290 %	Service factor	: 1.00
Breakdown torque	: 330 %	Temperature rise	: 80 K
Rated speed	: 1470 rpm	Design	: B

Locked rotor time : 32s (cold) 18s (hot)

Rev.	Changes Summary	Performed	Checked	Date
Performed by			Page 5 / 36	Revision
Checked by				
Date	14/04/2022			

TORQUE AND CURRENT VS SPEED CURVE

Three Phase Induction Motor - Squirrel Cage



Customer :

Product line : NEMA Premium Efficiency Three-Phase

Product code : 12447067

Catalog # : 02518ET3E284TC-W22

TORQUE AND CURRENT VS SPEED CURVE

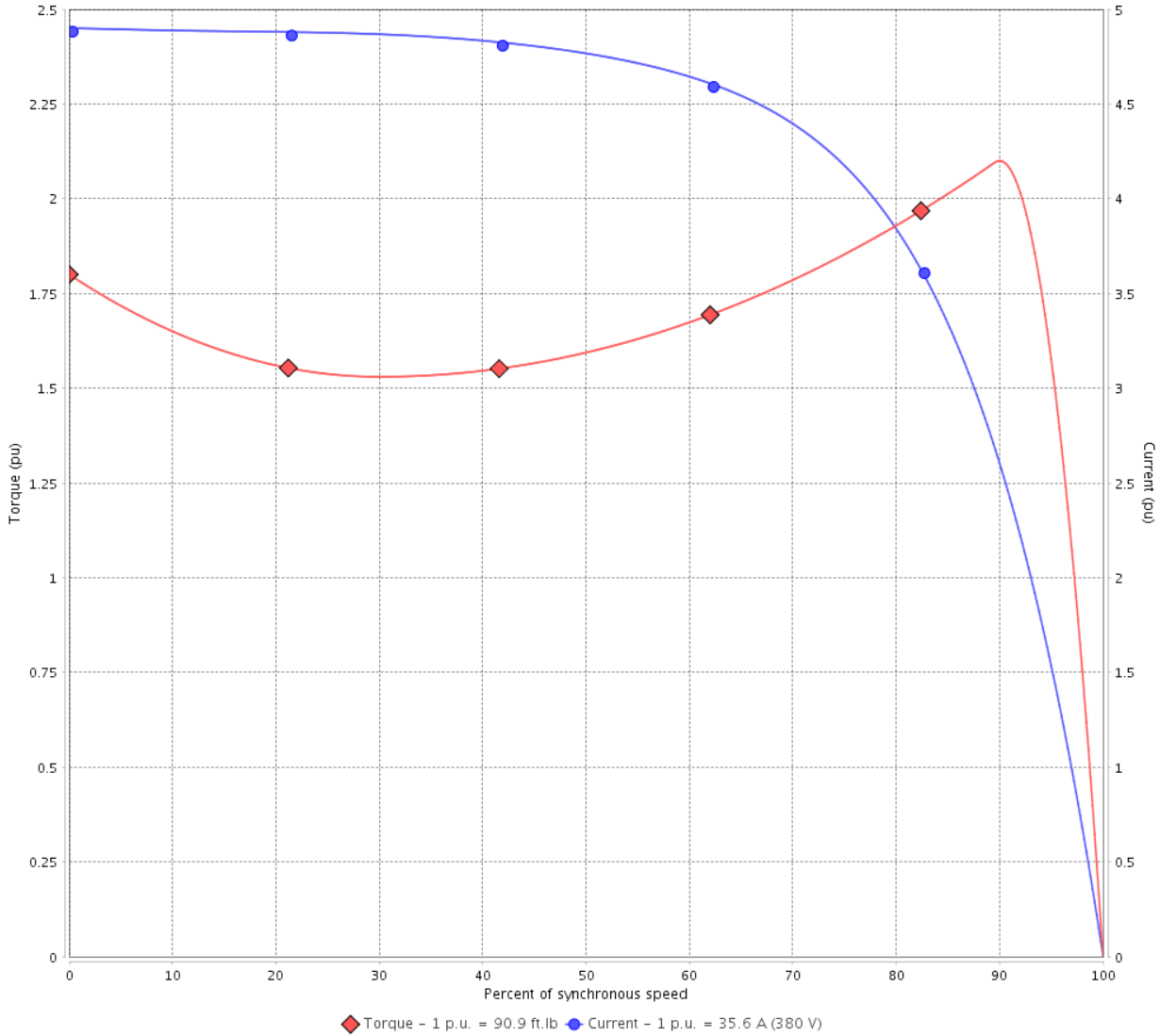

Performance : 380 V 50 Hz 4P IE2

Rated current	: 35.6 A	Moment of inertia (J)	: 5.11 sq.ft.lb
LRC	: 4.9	Duty cycle	: Cont.(S1)
Rated torque	: 90.9 ft.lb	Insulation class	: F
Locked rotor torque	: 180 %	Service factor	: 1.00
Breakdown torque	: 210 %	Temperature rise	: 105 K
Rated speed	: 1445 rpm	Design	: B

Locked rotor time : 32s (cold) 18s (hot)

Rev.	Changes Summary	Performed	Checked	Date
Performed by			Page 6 / 36	Revision
Checked by				
Date	14/04/2022			

TORQUE AND CURRENT VS SPEED CURVE



Three Phase Induction Motor - Squirrel Cage

Customer :

Product line : NEMA Premium Efficiency Three-Phase

Product code : 12447067

Catalog # : 02518ET3E284TC-W22

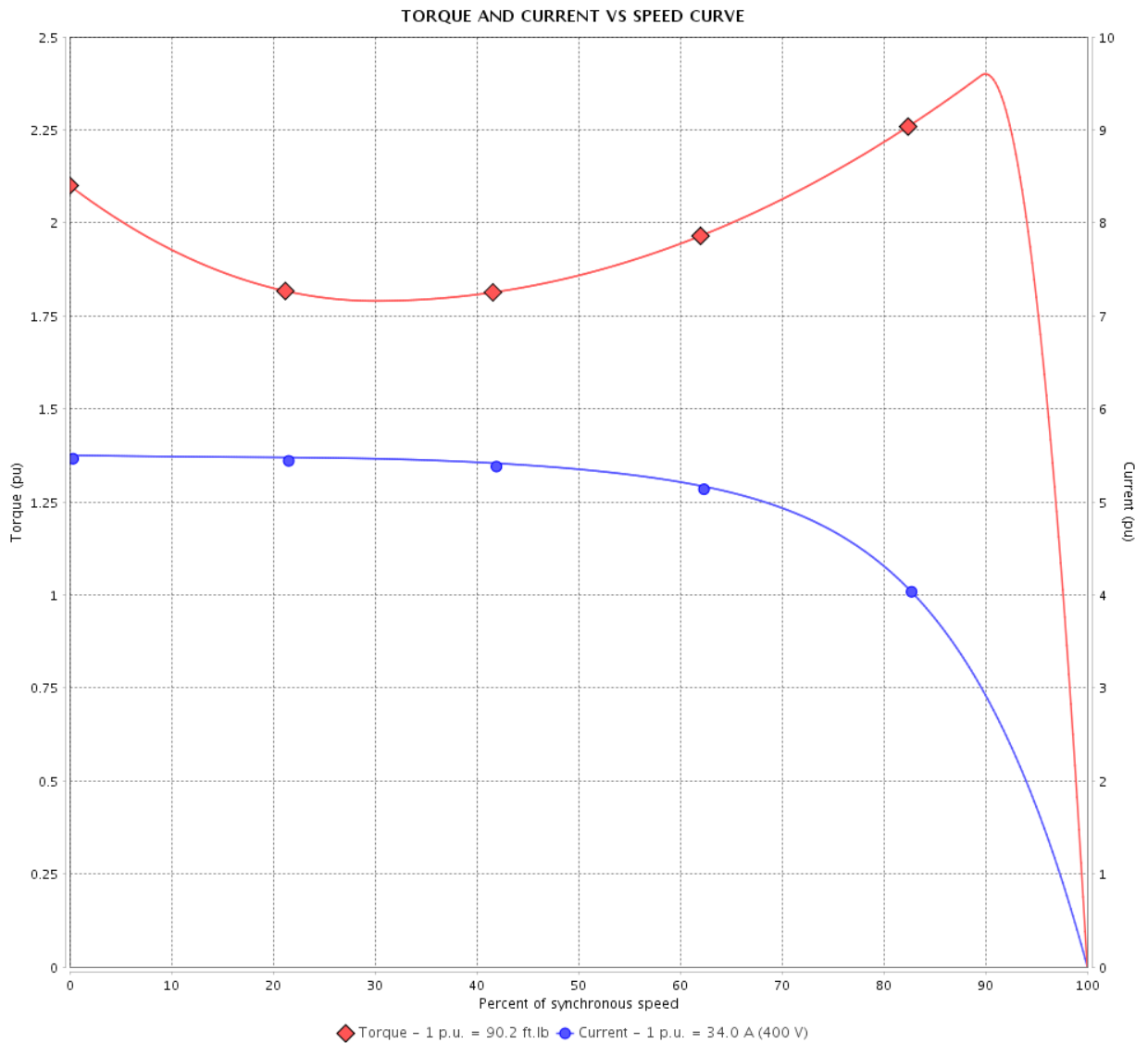

Performance : 400 V 50 Hz 4P IE2

Rated current	: 34.0 A	Moment of inertia (J)	: 5.11 sq.ft.lb
LRC	: 5.5	Duty cycle	: Cont.(S1)
Rated torque	: 90.2 ft.lb	Insulation class	: F
Locked rotor torque	: 210 %	Service factor	: 1.00
Breakdown torque	: 240 %	Temperature rise	: 105 K
Rated speed	: 1455 rpm	Design	: B

Locked rotor time : 32s (cold) 18s (hot)

Rev.	Changes Summary	Performed	Checked	Date
Performed by			Page	Revision
Checked by			7 / 36	
Date	14/04/2022			

TORQUE AND CURRENT VS SPEED CURVE

Three Phase Induction Motor - Squirrel Cage



Customer :

Product line : NEMA Premium Efficiency Three-Phase

Product code : 12447067

Catalog # : 02518ET3E284TC-W22

TORQUE AND CURRENT VS SPEED CURVE

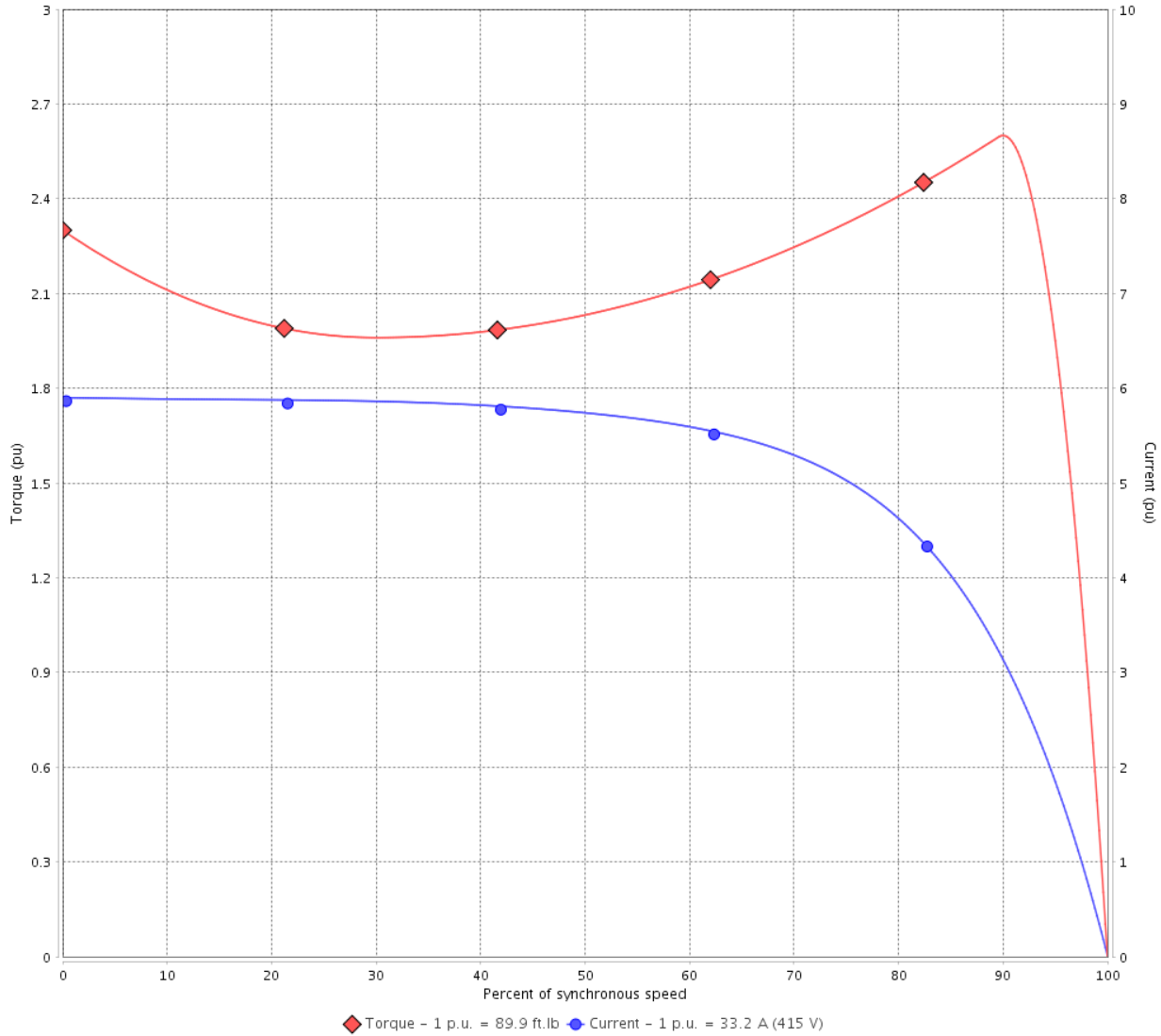

Performance : 415 V 50 Hz 4P IE2

Rated current	: 33.2 A	Moment of inertia (J)	: 5.11 sq.ft.lb
LRC	: 5.9	Duty cycle	: Cont.(S1)
Rated torque	: 89.9 ft.lb	Insulation class	: F
Locked rotor torque	: 229 %	Service factor	: 1.00
Breakdown torque	: 260 %	Temperature rise	: 80 K
Rated speed	: 1460 rpm	Design	: B

Locked rotor time : 32s (cold) 18s (hot)

Rev.	Changes Summary	Performed	Checked	Date
Performed by			Page 8 / 36	Revision
Checked by				
Date	14/04/2022			

LOAD PERFORMANCE CURVE

Three Phase Induction Motor - Squirrel Cage



Customer :

Product line : NEMA Premium Efficiency Three-Phase

Product code : 12447067

Catalog # : 02518ET3E284TC-W22

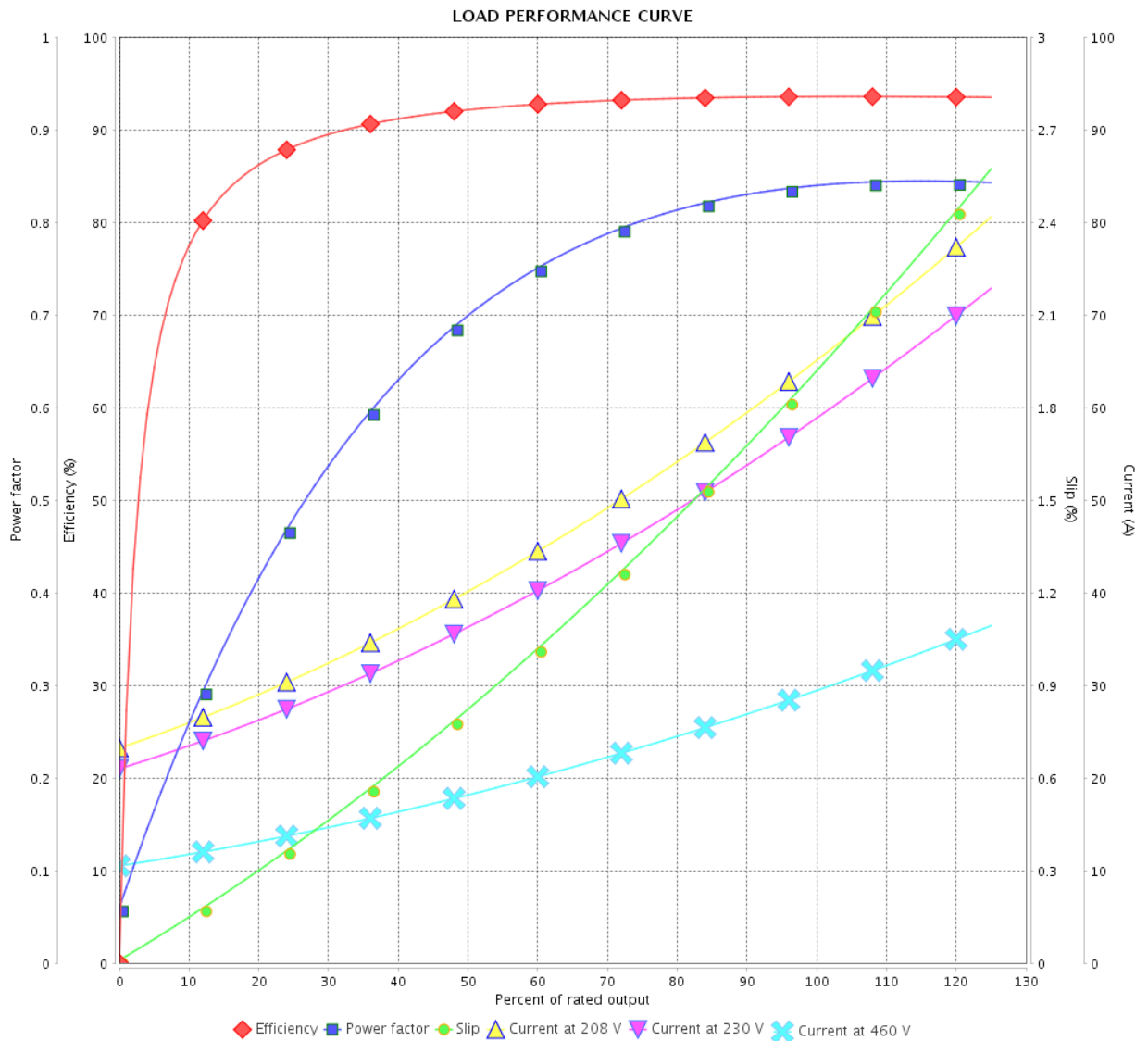

Performance : 230/460 V 60 Hz 4P

Rated current : 59.0/29.5 A
 LRC : 6.2
 Rated torque : 74.4 ft.lb
 Locked rotor torque : 240 %
 Breakdown torque : 270 %
 Rated speed : 1765 rpm

Moment of inertia (J) : 5.11 sq.ft.lb
 Duty cycle : Cont.(S1)
 Insulation class : F
 Service factor : 1.25
 Temperature rise : 80 K
 Design : B

Rev.	Changes Summary	Performed	Checked	Date
Performed by			Page	Revision
Checked by				
Date				

LOAD PERFORMANCE CURVE

Three Phase Induction Motor - Squirrel Cage



Customer :

Product line : NEMA Premium Efficiency Three-Phase

Product code : 12447067

Catalog # : 02518ET3E284TC-W22

LOAD PERFORMANCE CURVE

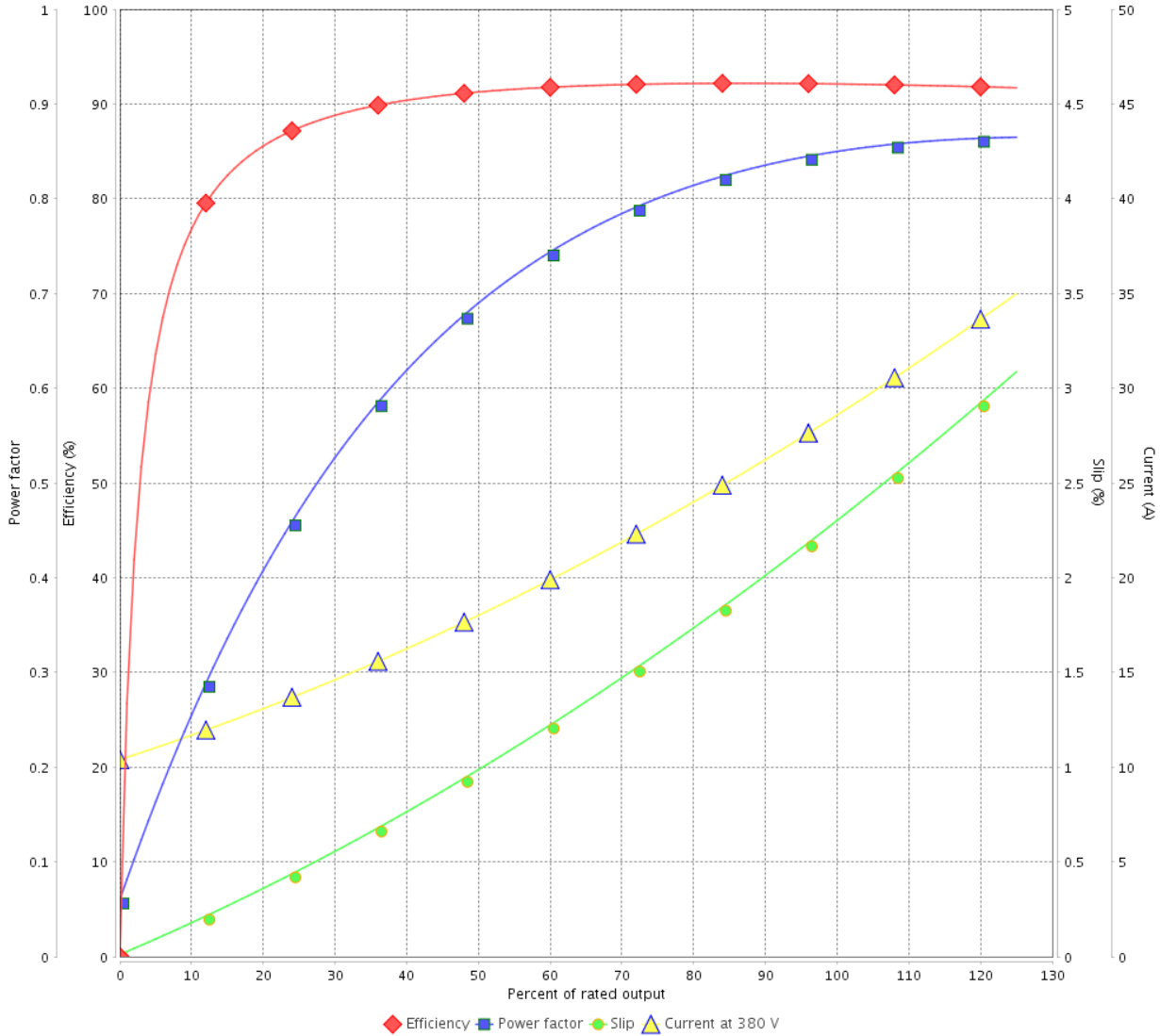

Performance : 380 V 50 Hz 4P IE3

Rated current : 29.1 A
 LRC : 6.0
 Rated torque : 71.7 ft.lb
 Locked rotor torque : 229 %
 Breakdown torque : 260 %
 Rated speed : 1465 rpm

Moment of inertia (J) : 5.11 sq.ft.lb
 Duty cycle : Cont.(S1)
 Insulation class : F
 Service factor : 1.00
 Temperature rise : 80 K
 Design : B

Rev.	Changes Summary	Performed	Checked	Date
Performed by			Page 10 / 36	Revision
Checked by				
Date	14/04/2022			

LOAD PERFORMANCE CURVE

Three Phase Induction Motor - Squirrel Cage



Customer :

Product line : NEMA Premium Efficiency Three-Phase

Product code : 12447067

Catalog # : 02518ET3E284TC-W22

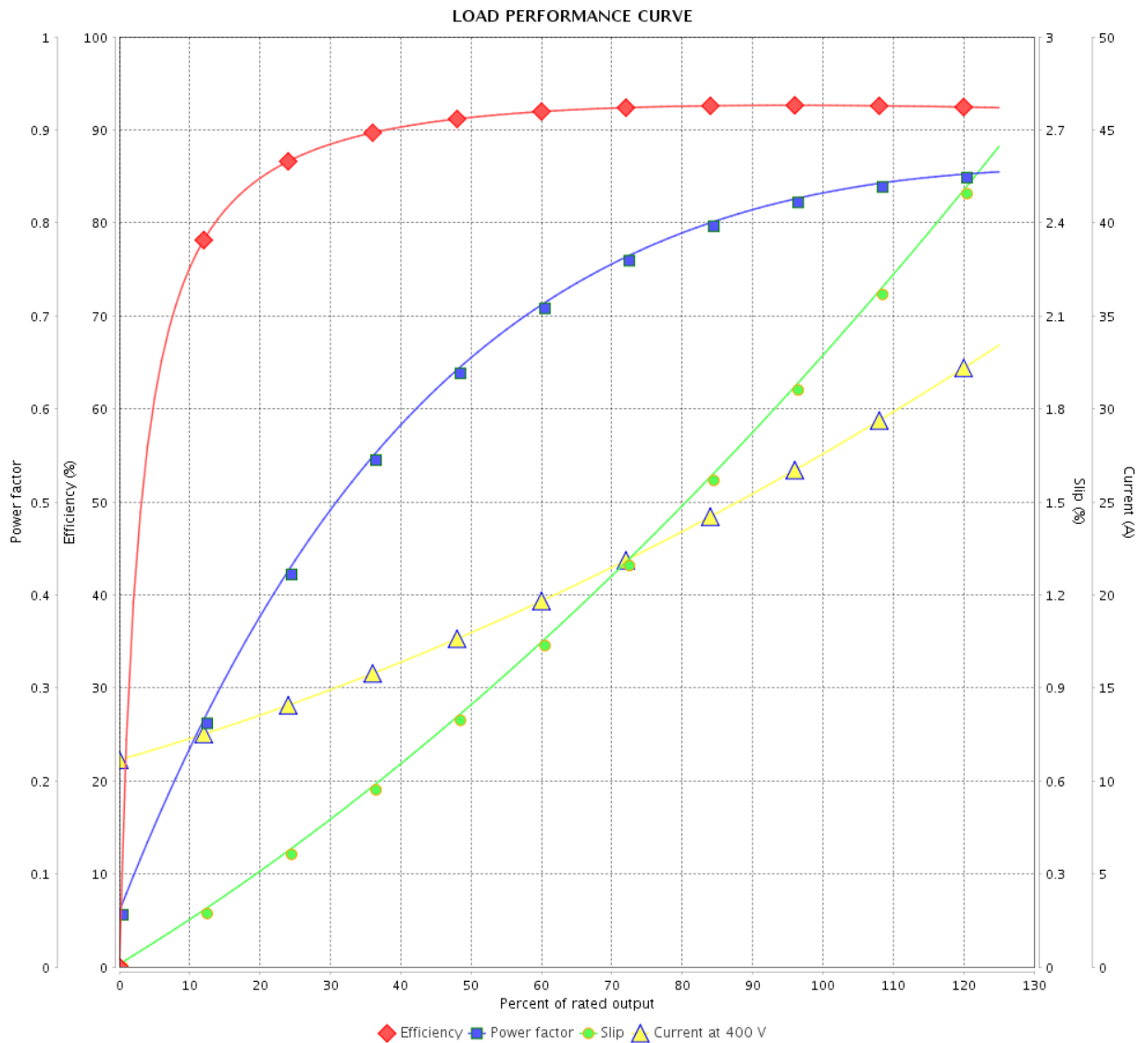

Performance : 400 V 50 Hz 4P IE3

Rated current : 28.2 A
 LRC : 6.7
 Rated torque : 71.4 ft.lb
 Locked rotor torque : 260 %
 Breakdown torque : 300 %
 Rated speed : 1470 rpm

Moment of inertia (J) : 5.11 sq.ft.lb
 Duty cycle : Cont.(S1)
 Insulation class : F
 Service factor : 1.00
 Temperature rise : 80 K
 Design : B

Rev.	Changes Summary	Performed	Checked	Date
Performed by			Page	Revision
Checked by				
Date				
			11 / 36	

LOAD PERFORMANCE CURVE

Three Phase Induction Motor - Squirrel Cage



Customer :

Product line : NEMA Premium Efficiency Three-Phase

Product code : 12447067

Catalog # : 02518ET3E284TC-W22

LOAD PERFORMANCE CURVE

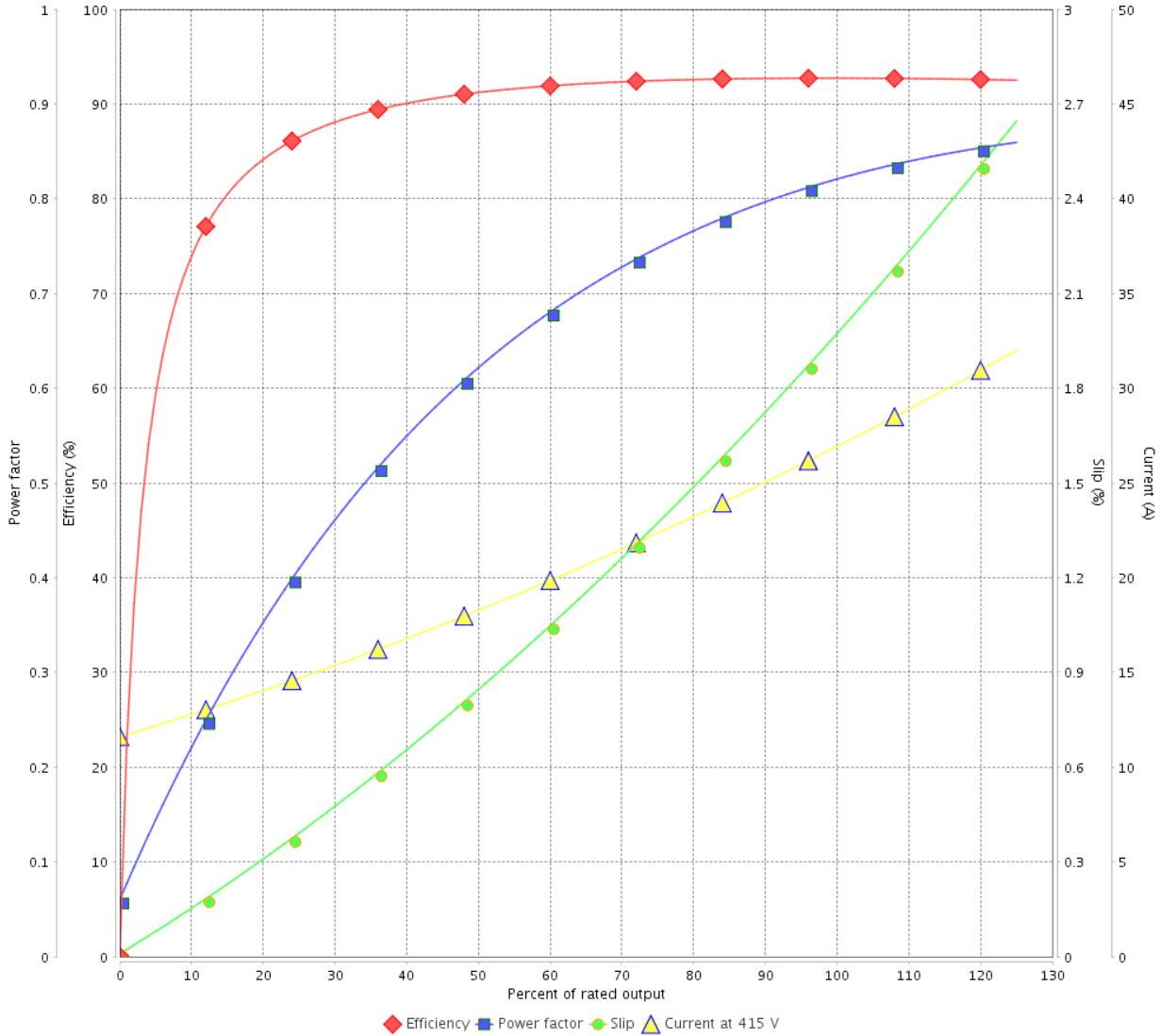

Performance : 415 V 50 Hz 4P IE3

Rated current : 27.5 A
 LRC : 7.2
 Rated torque : 71.4 ft.lb
 Locked rotor torque : 290 %
 Breakdown torque : 330 %
 Rated speed : 1470 rpm

Moment of inertia (J) : 5.11 sq.ft.lb
 Duty cycle : Cont.(S1)
 Insulation class : F
 Service factor : 1.00
 Temperature rise : 80 K
 Design : B

Rev.	Changes Summary	Performed	Checked	Date
Performed by			Page 12 / 36	Revision
Checked by				
Date	14/04/2022			

LOAD PERFORMANCE CURVE

Three Phase Induction Motor - Squirrel Cage



Customer : _____

Product line : NEMA Premium Efficiency Three-Phase

Product code : 12447067

Catalog # : 02518ET3E284TC-W22

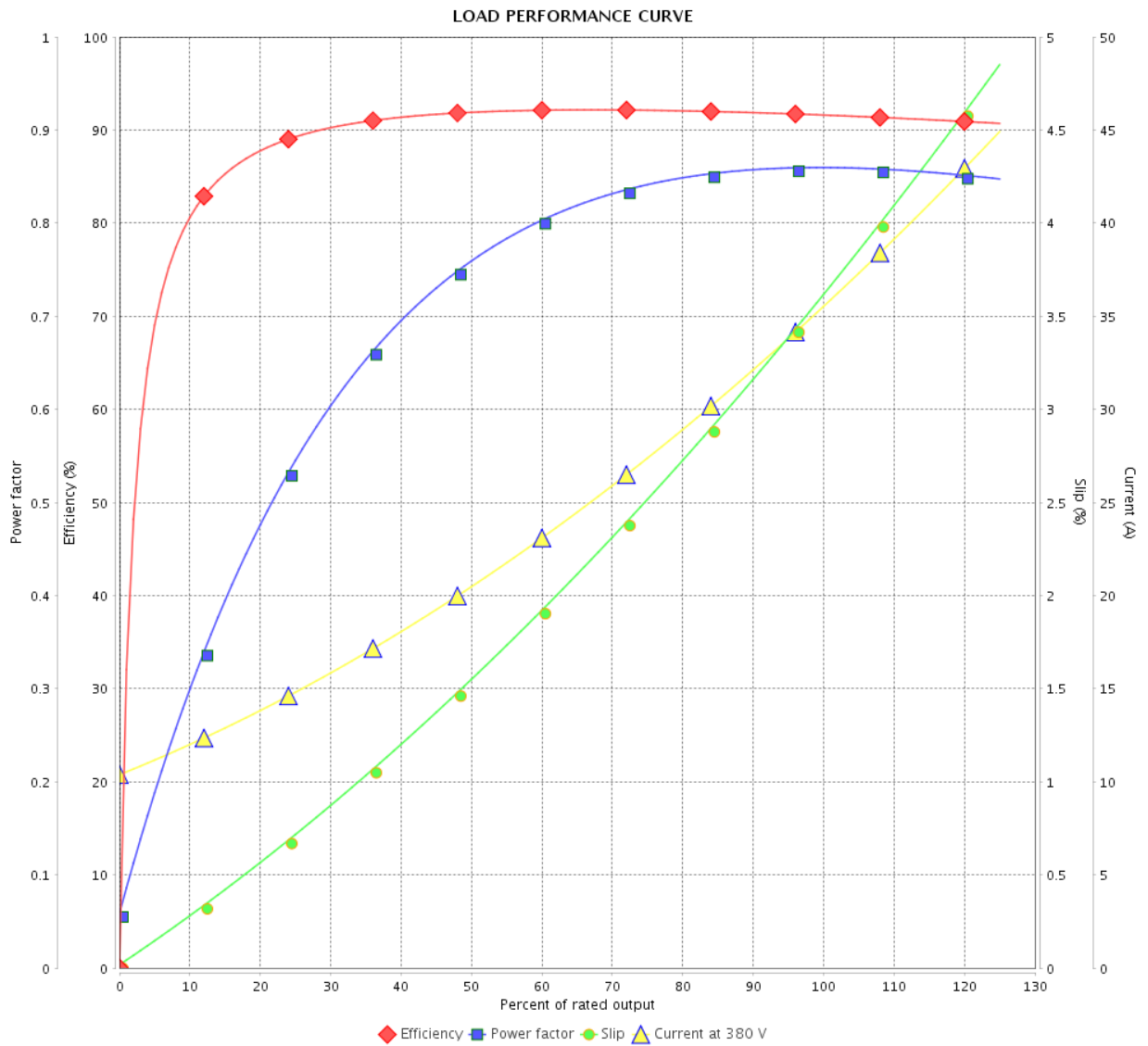

Performance : 380 V 50 Hz 4P IE2

Rated current : 35.6 A
 LRC : 4.9
 Rated torque : 90.9 ft.lb
 Locked rotor torque : 180 %
 Breakdown torque : 210 %
 Rated speed : 1445 rpm

Moment of inertia (J) : 5.11 sq.ft.lb
 Duty cycle : Cont.(S1)
 Insulation class : F
 Service factor : 1.00
 Temperature rise : 105 K
 Design : B

Rev.	Changes Summary	Performed	Checked	Date
Performed by		Page		Revision
Checked by		13 / 36		
Date		14/04/2022		

LOAD PERFORMANCE CURVE

Three Phase Induction Motor - Squirrel Cage



Customer : _____

Product line : NEMA Premium Efficiency Three-Phase

Product code : 12447067

Catalog # : 02518ET3E284TC-W22

LOAD PERFORMANCE CURVE

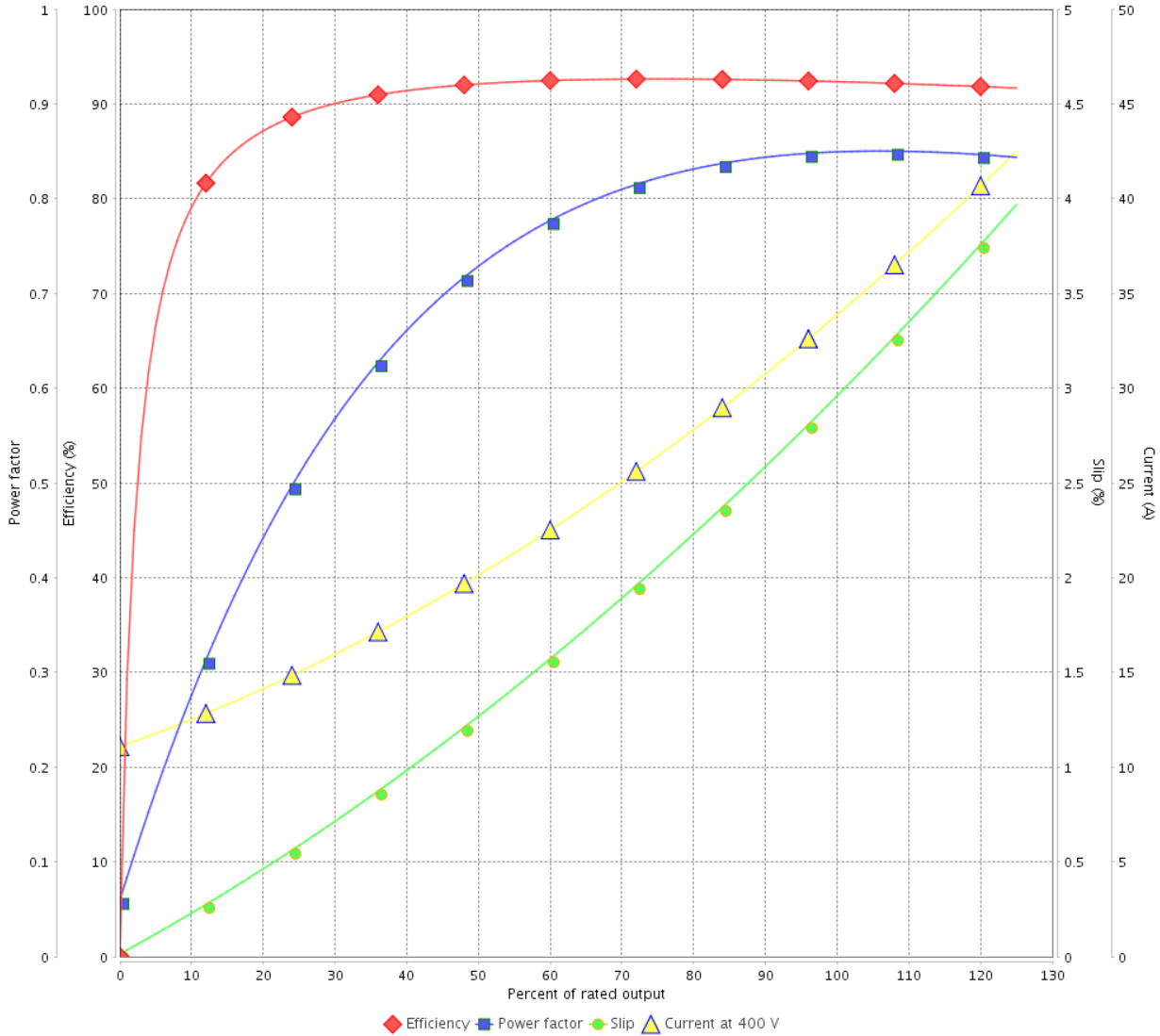

Performance : 400 V 50 Hz 4P IE2

Rated current : 34.0 A
 LRC : 5.5
 Rated torque : 90.2 ft.lb
 Locked rotor torque : 210 %
 Breakdown torque : 240 %
 Rated speed : 1455 rpm

Moment of inertia (J) : 5.11 sq.ft.lb
 Duty cycle : Cont.(S1)
 Insulation class : F
 Service factor : 1.00
 Temperature rise : 105 K
 Design : B

Rev.	Changes Summary	Performed	Checked	Date
Performed by		Page		Revision
Checked by		14 / 36		
Date		14/04/2022		

LOAD PERFORMANCE CURVE

Three Phase Induction Motor - Squirrel Cage



Customer :

Product line : NEMA Premium Efficiency Three-Phase

Product code : 12447067

Catalog # : 02518ET3E284TC-W22

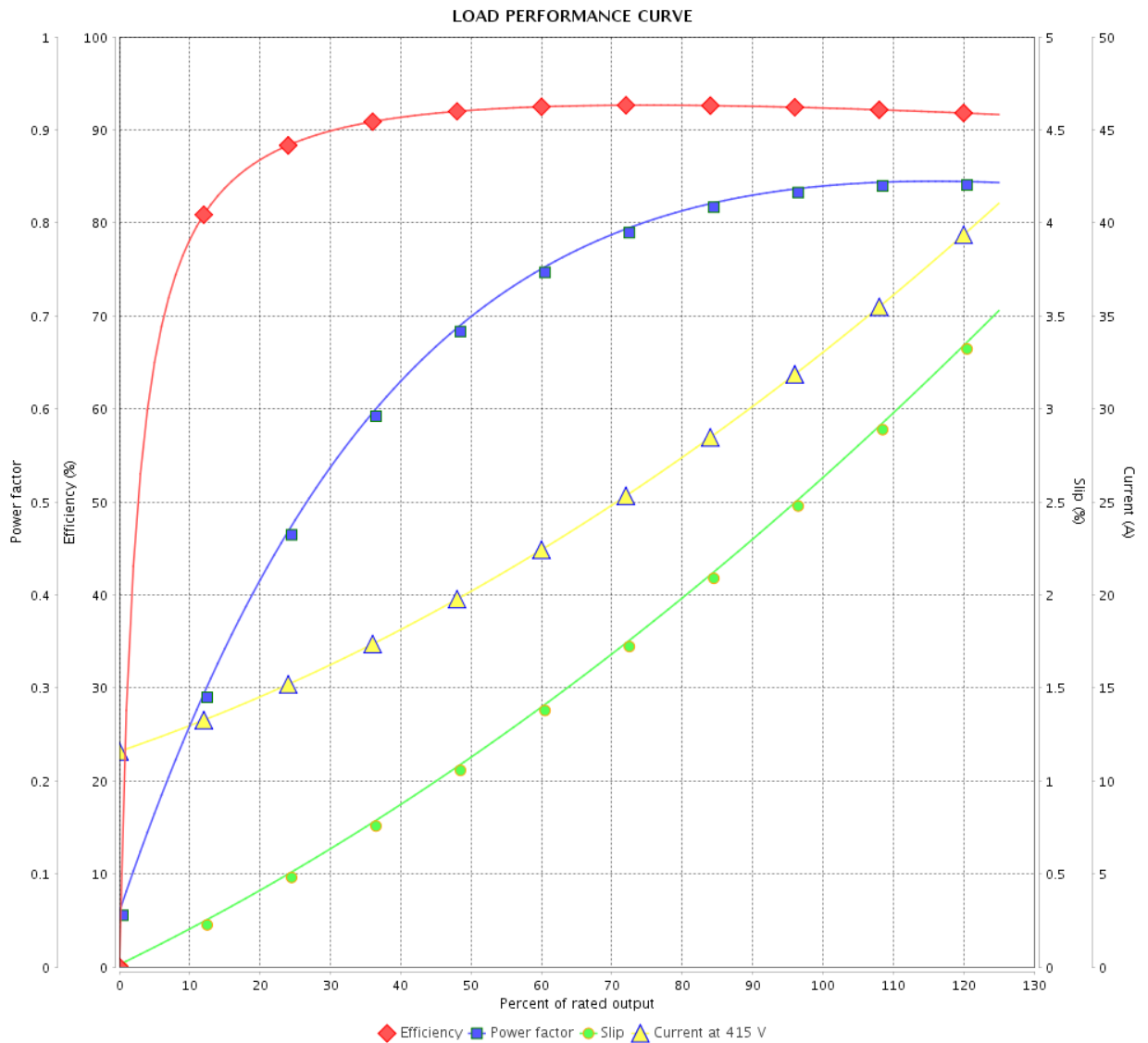

Performance : 415 V 50 Hz 4P IE2

Rated current : 33.2 A
 LRC : 5.9
 Rated torque : 89.9 ft.lb
 Locked rotor torque : 229 %
 Breakdown torque : 260 %
 Rated speed : 1460 rpm

Moment of inertia (J) : 5.11 sq.ft.lb
 Duty cycle : Cont.(S1)
 Insulation class : F
 Service factor : 1.00
 Temperature rise : 80 K
 Design : B

Rev.	Changes Summary	Performed	Checked	Date
Performed by			Page	Revision
Checked by			15 / 36	
Date	14/04/2022			

THERMAL LIMIT CURVE



Three Phase Induction Motor - Squirrel Cage

Customer :

Product line : NEMA Premium Efficiency Three-Phase
Product code : 12447067
Catalog # : 02518ET3E284TC-W22

Performance : 230/460 V 60 Hz 4P

Rated current	: 59.0/29.5 A	Moment of inertia (J)	: 5.11 sq.ft.lb
LRC	: 6.2	Duty cycle	: Cont.(S1)
Rated torque	: 74.4 ft.lb	Insulation class	: F
Locked rotor torque	: 240 %	Service factor	: 1.25
Breakdown torque	: 270 %	Temperature rise	: 80 K
Rated speed	: 1765 rpm	Design	: B

Heating constant

Cooling constant

Rev.	Changes Summary	Performed	Checked	Date
Performed by				
Checked by			Page	Revision
Date	14/04/2022		16 / 36	

THERMAL LIMIT CURVE

Three Phase Induction Motor - Squirrel Cage



Customer : _____

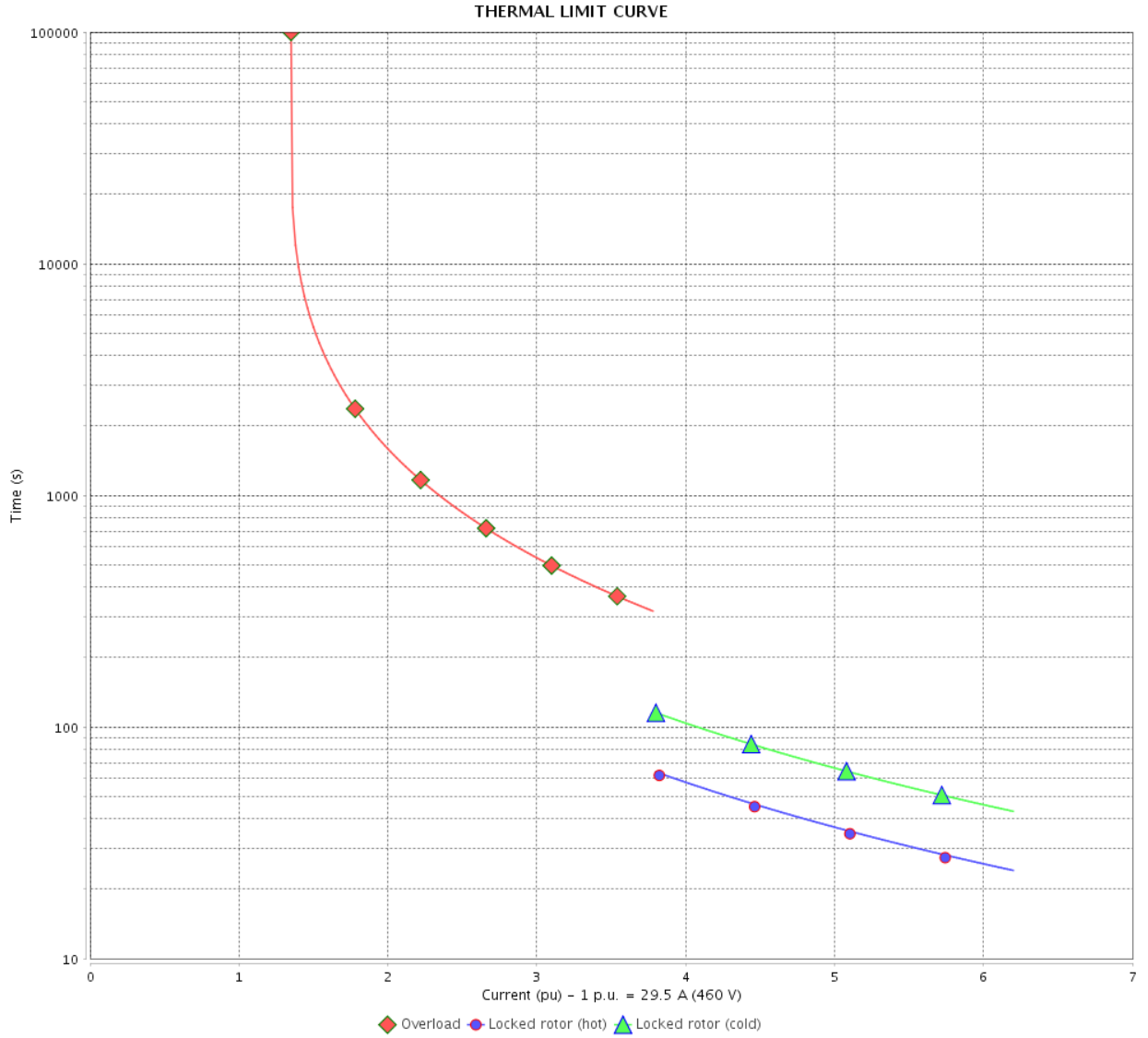

Rev.	Changes Summary	Performed	Checked	Date
Performed by		Page 17 / 36		Revision
Checked by				
Date				

THERMAL LIMIT CURVE



Three Phase Induction Motor - Squirrel Cage

Customer :

Product line : NEMA Premium Efficiency Three-Phase
Product code : 12447067
Catalog # : 02518ET3E284TC-W22

Performance : 380 V 50 Hz 4P IE3

Rated current	: 29.1 A	Moment of inertia (J)	: 5.11 sq.ft.lb
LRC	: 6.0	Duty cycle	: Cont.(S1)
Rated torque	: 71.7 ft.lb	Insulation class	: F
Locked rotor torque	: 229 %	Service factor	: 1.00
Breakdown torque	: 260 %	Temperature rise	: 80 K
Rated speed	: 1465 rpm	Design	: B

Heating constant

Cooling constant

Rev.	Changes Summary	Performed	Checked	Date
Performed by				
Checked by			Page	Revision
Date	14/04/2022		18 / 36	

THERMAL LIMIT CURVE

Three Phase Induction Motor - Squirrel Cage



Customer : _____

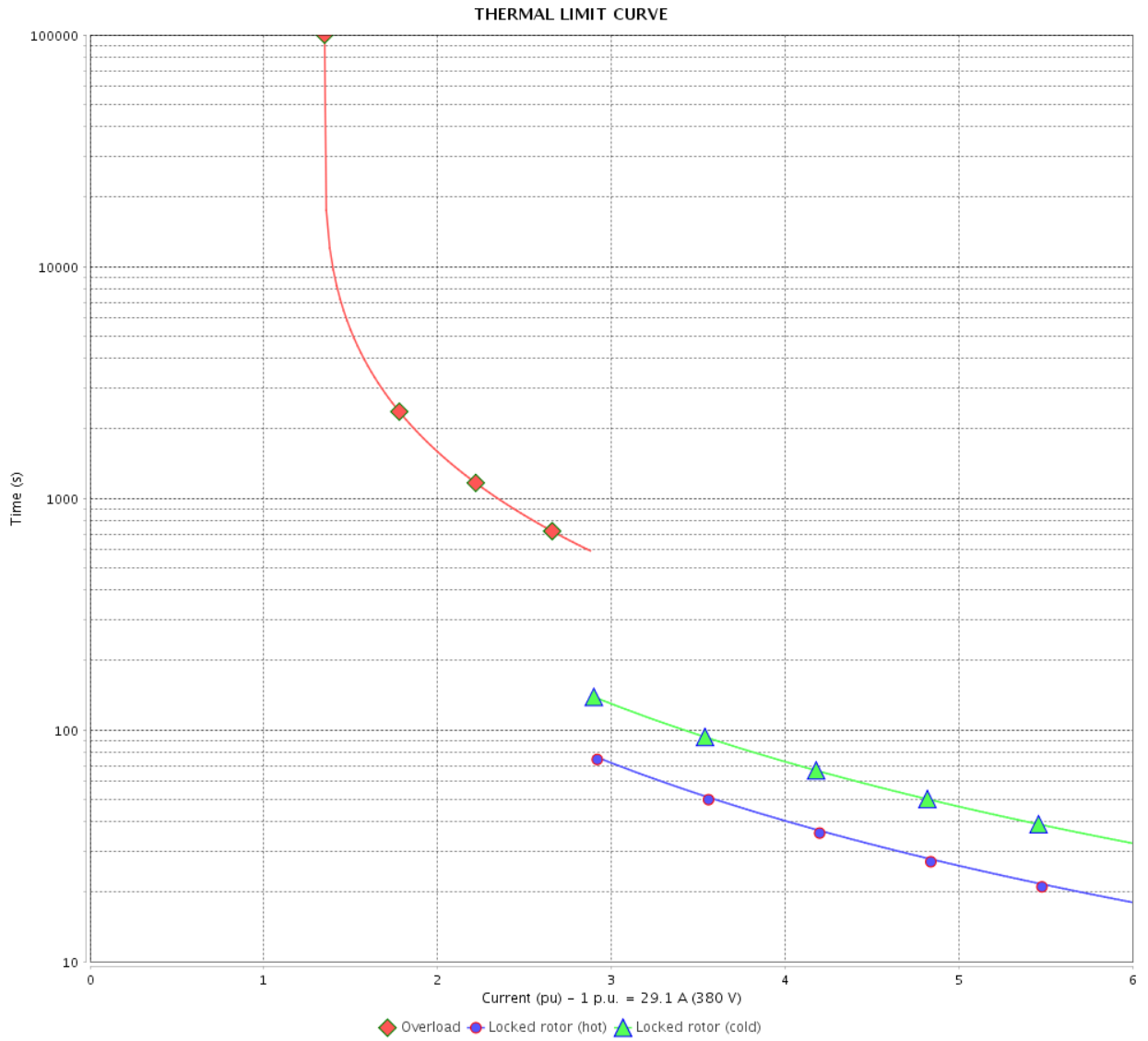

Rev.	Changes Summary	Performed	Checked	Date
Performed by				
Checked by				
Date				
		Page	Revision	
		19 / 36		

THERMAL LIMIT CURVE



Three Phase Induction Motor - Squirrel Cage

Customer :

Product line : NEMA Premium Efficiency Three-Phase
Product code : 12447067
Catalog # : 02518ET3E284TC-W22

Performance : 400 V 50 Hz 4P IE3

Rated current	: 28.2 A	Moment of inertia (J)	: 5.11 sq.ft.lb
LRC	: 6.7	Duty cycle	: Cont.(S1)
Rated torque	: 71.4 ft.lb	Insulation class	: F
Locked rotor torque	: 260 %	Service factor	: 1.00
Breakdown torque	: 300 %	Temperature rise	: 80 K
Rated speed	: 1470 rpm	Design	: B

Heating constant

Cooling constant

Rev.	Changes Summary	Performed	Checked	Date
Performed by				
Checked by			Page	Revision
Date	14/04/2022		20 / 36	

THERMAL LIMIT CURVE

Three Phase Induction Motor - Squirrel Cage



Customer : _____

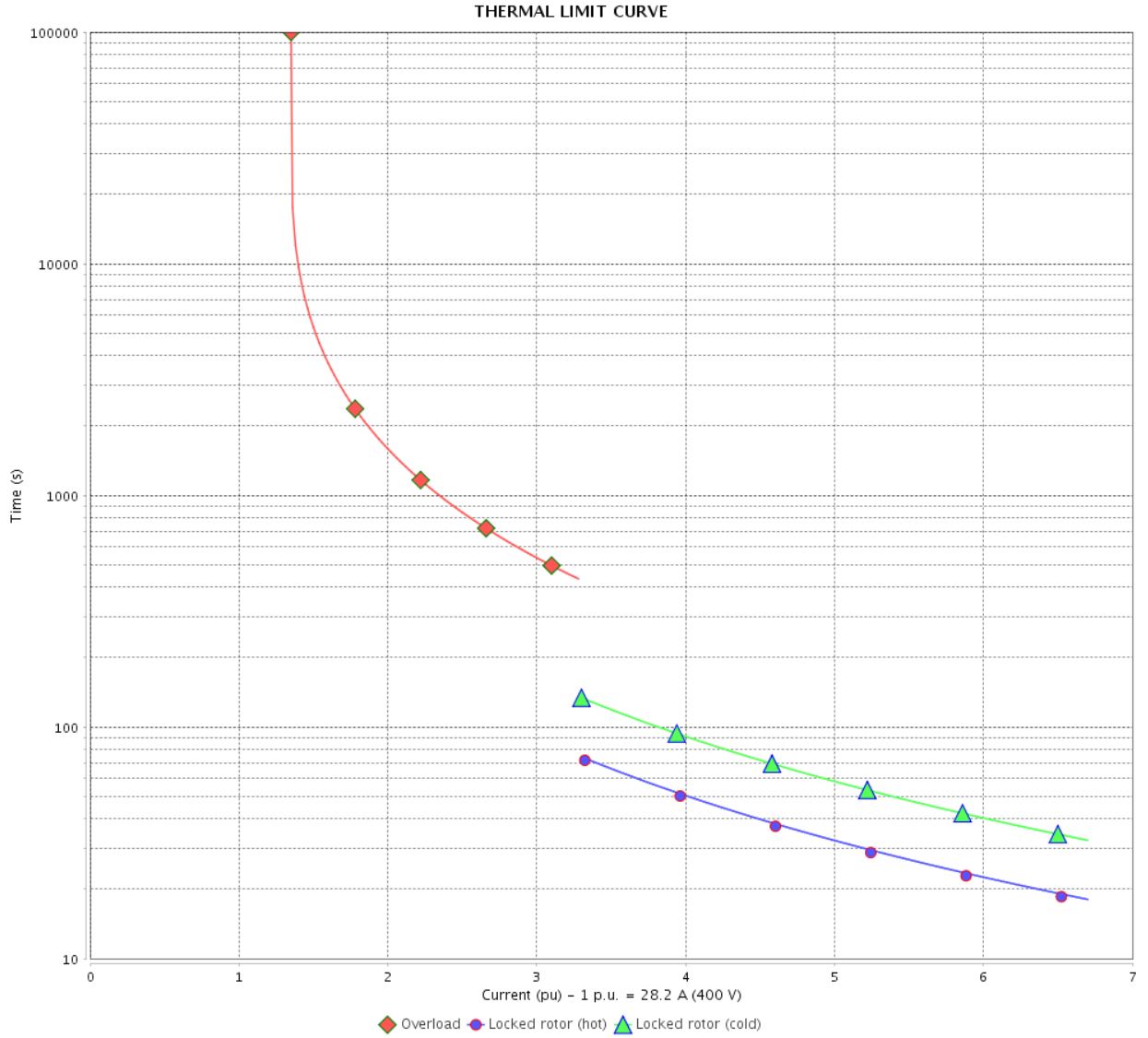

Rev.	Changes Summary	Performed	Checked	Date
Performed by		Page 21 / 36		Revision
Checked by				
Date				

THERMAL LIMIT CURVE



Three Phase Induction Motor - Squirrel Cage

Customer :

Product line : NEMA Premium Efficiency Three-Phase
Product code : 12447067
Catalog # : 02518ET3E284TC-W22

Performance : 415 V 50 Hz 4P IE3

Rated current	: 27.5 A	Moment of inertia (J)	: 5.11 sq.ft.lb
LRC	: 7.2	Duty cycle	: Cont.(S1)
Rated torque	: 71.4 ft.lb	Insulation class	: F
Locked rotor torque	: 290 %	Service factor	: 1.00
Breakdown torque	: 330 %	Temperature rise	: 80 K
Rated speed	: 1470 rpm	Design	: B

Heating constant

Cooling constant

Rev.	Changes Summary	Performed	Checked	Date
Performed by				
Checked by			Page	Revision
Date	14/04/2022		22 / 36	

THERMAL LIMIT CURVE

Three Phase Induction Motor - Squirrel Cage



Customer : _____

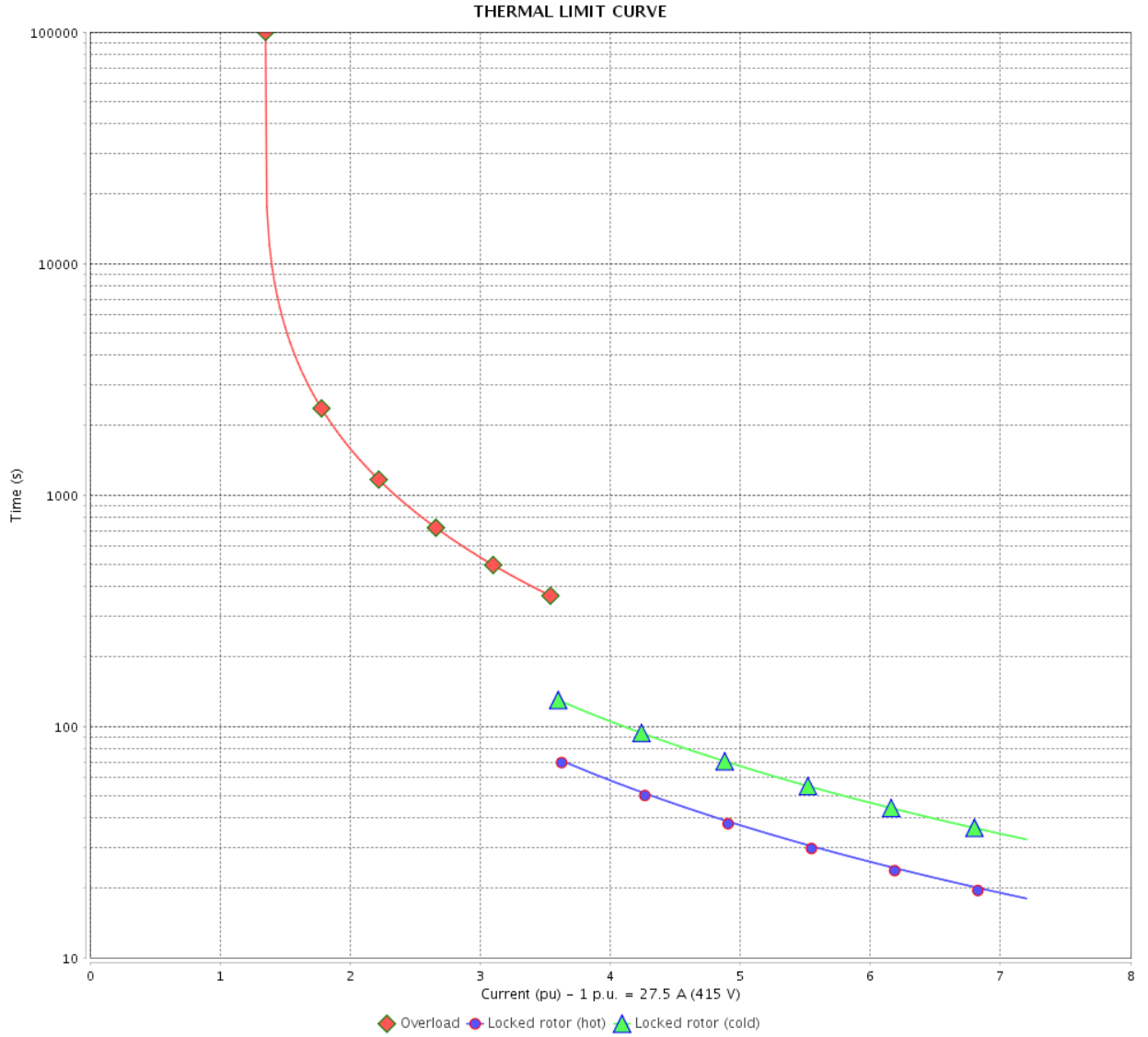

Rev.	Changes Summary	Performed	Checked	Date
Performed by				
Checked by				
Date				
			Page	Revision
			23 / 36	

THERMAL LIMIT CURVE

Three Phase Induction Motor - Squirrel Cage



Customer :

Product line : NEMA Premium Efficiency Three-Phase
Product code : 12447067
Catalog # : 02518ET3E284TC-W22

Performance : 380 V 50 Hz 4P IE2

Rated current	: 35.6 A	Moment of inertia (J)	: 5.11 sq.ft.lb
LRC	: 4.9	Duty cycle	: Cont.(S1)
Rated torque	: 90.9 ft.lb	Insulation class	: F
Locked rotor torque	: 180 %	Service factor	: 1.00
Breakdown torque	: 210 %	Temperature rise	: 105 K
Rated speed	: 1445 rpm	Design	: B

Heating constant

Cooling constant

Rev.	Changes Summary	Performed	Checked	Date
Performed by				
Checked by			Page	Revision
Date	14/04/2022		24 / 36	

THERMAL LIMIT CURVE

Three Phase Induction Motor - Squirrel Cage



Customer : _____

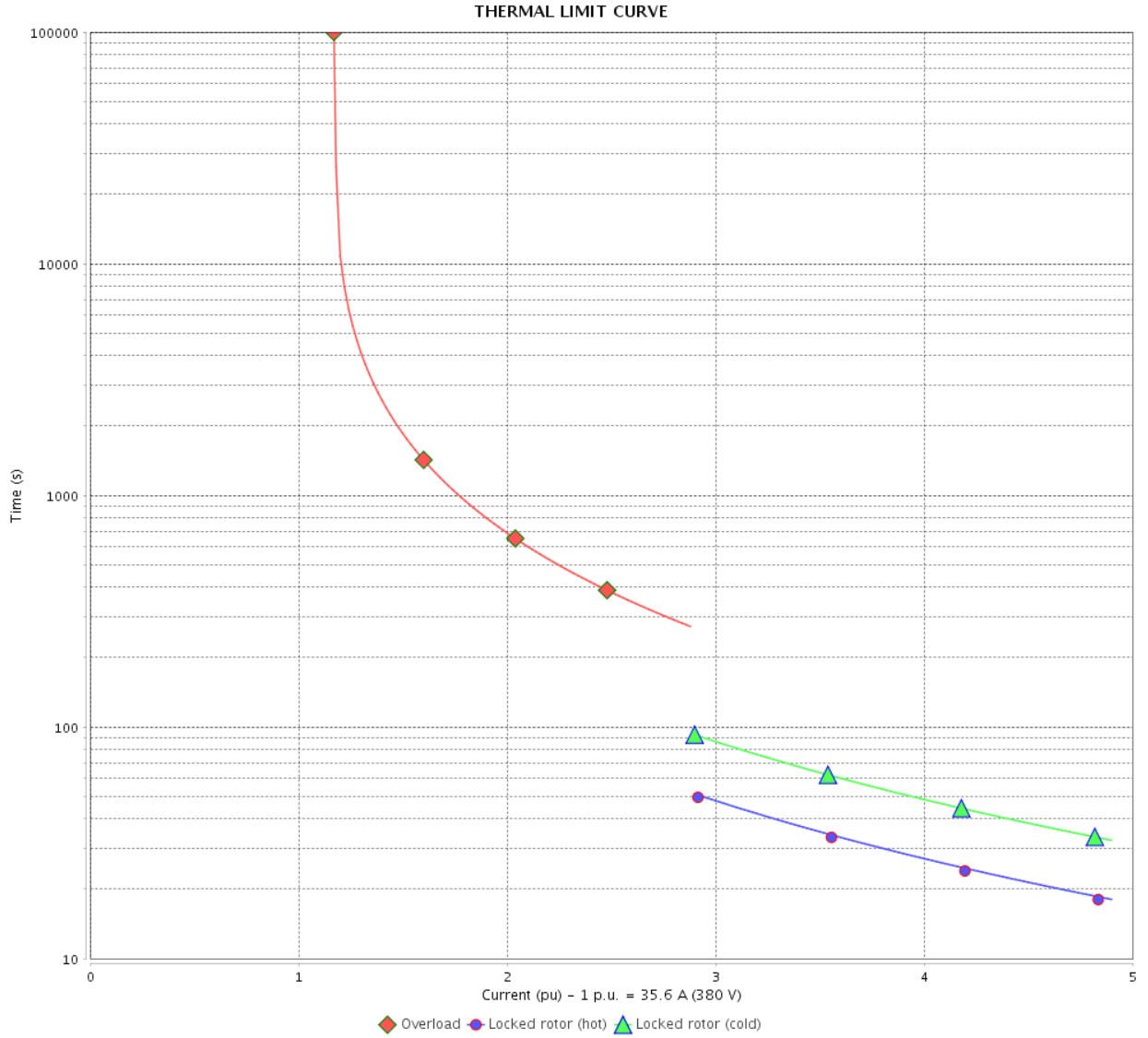

Rev.	Changes Summary	Performed	Checked	Date
Performed by		Page		Revision
Checked by		25 / 36		
Date		14/04/2022		

THERMAL LIMIT CURVE



Three Phase Induction Motor - Squirrel Cage

Customer :

Product line : NEMA Premium Efficiency Three-Phase
Product code : 12447067
Catalog # : 02518ET3E284TC-W22

Performance : 400 V 50 Hz 4P IE2

Rated current	: 34.0 A	Moment of inertia (J)	: 5.11 sq.ft.lb
LRC	: 5.5	Duty cycle	: Cont.(S1)
Rated torque	: 90.2 ft.lb	Insulation class	: F
Locked rotor torque	: 210 %	Service factor	: 1.00
Breakdown torque	: 240 %	Temperature rise	: 105 K
Rated speed	: 1455 rpm	Design	: B

Heating constant

Cooling constant

Rev.	Changes Summary	Performed	Checked	Date
Performed by				
Checked by			Page	Revision
Date	14/04/2022		26 / 36	

THERMAL LIMIT CURVE

Three Phase Induction Motor - Squirrel Cage



Customer : _____

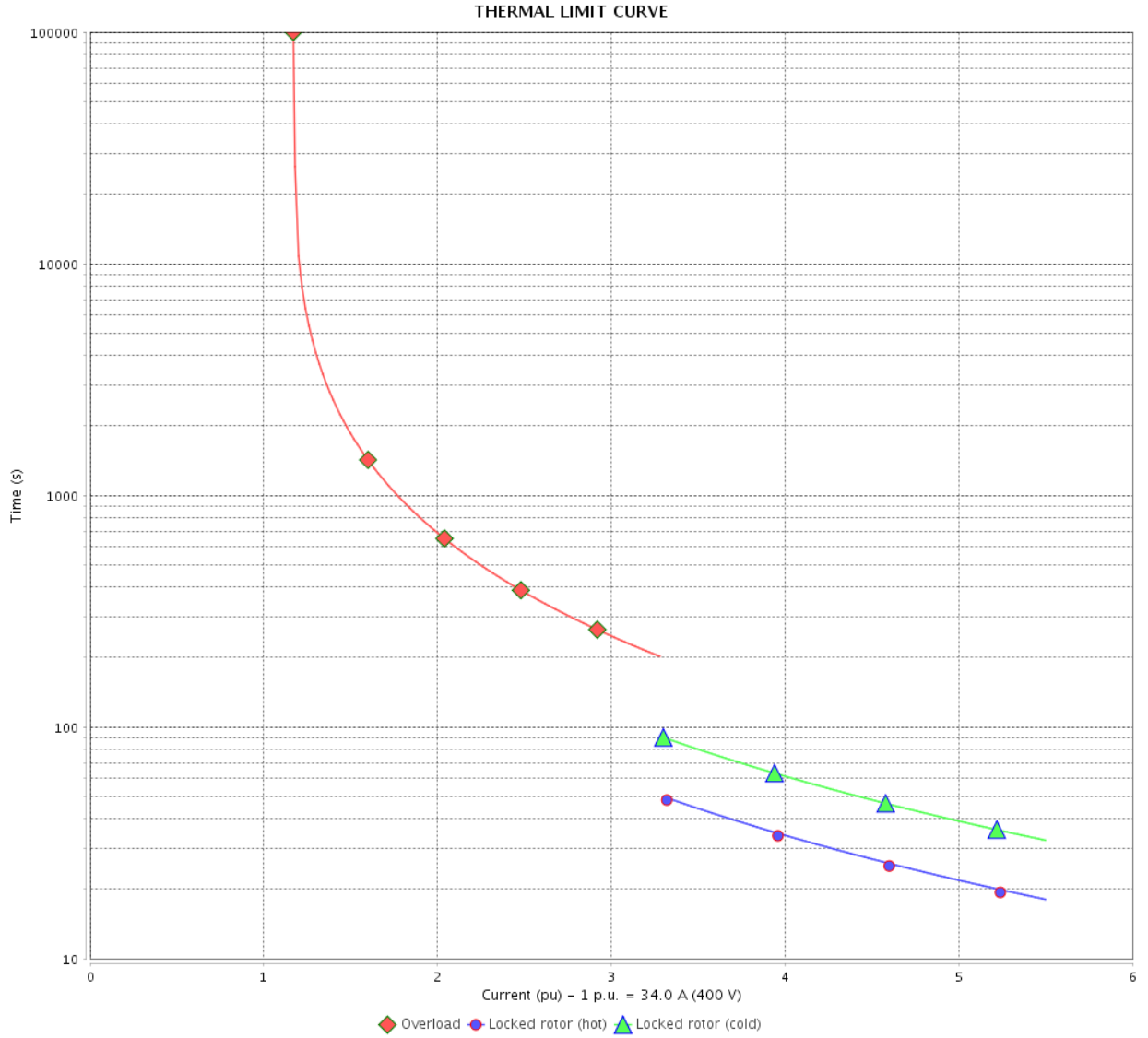

Rev.	Changes Summary	Performed	Checked	Date
Performed by		Page		Revision
Checked by		27 / 36		
Date		14/04/2022		

THERMAL LIMIT CURVE



Three Phase Induction Motor - Squirrel Cage

Customer :

Product line : NEMA Premium Efficiency Three-Phase
Product code : 12447067
Catalog # : 02518ET3E284TC-W22

Performance : 415 V 50 Hz 4P IE2

Rated current	: 33.2 A	Moment of inertia (J)	: 5.11 sq.ft.lb
LRC	: 5.9	Duty cycle	: Cont.(S1)
Rated torque	: 89.9 ft.lb	Insulation class	: F
Locked rotor torque	: 229 %	Service factor	: 1.00
Breakdown torque	: 260 %	Temperature rise	: 80 K
Rated speed	: 1460 rpm	Design	: B

Heating constant

Cooling constant

Rev.	Changes Summary	Performed	Checked	Date
Performed by				
Checked by			Page	Revision
Date	14/04/2022		28 / 36	

THERMAL LIMIT CURVE

Three Phase Induction Motor - Squirrel Cage



Customer : _____

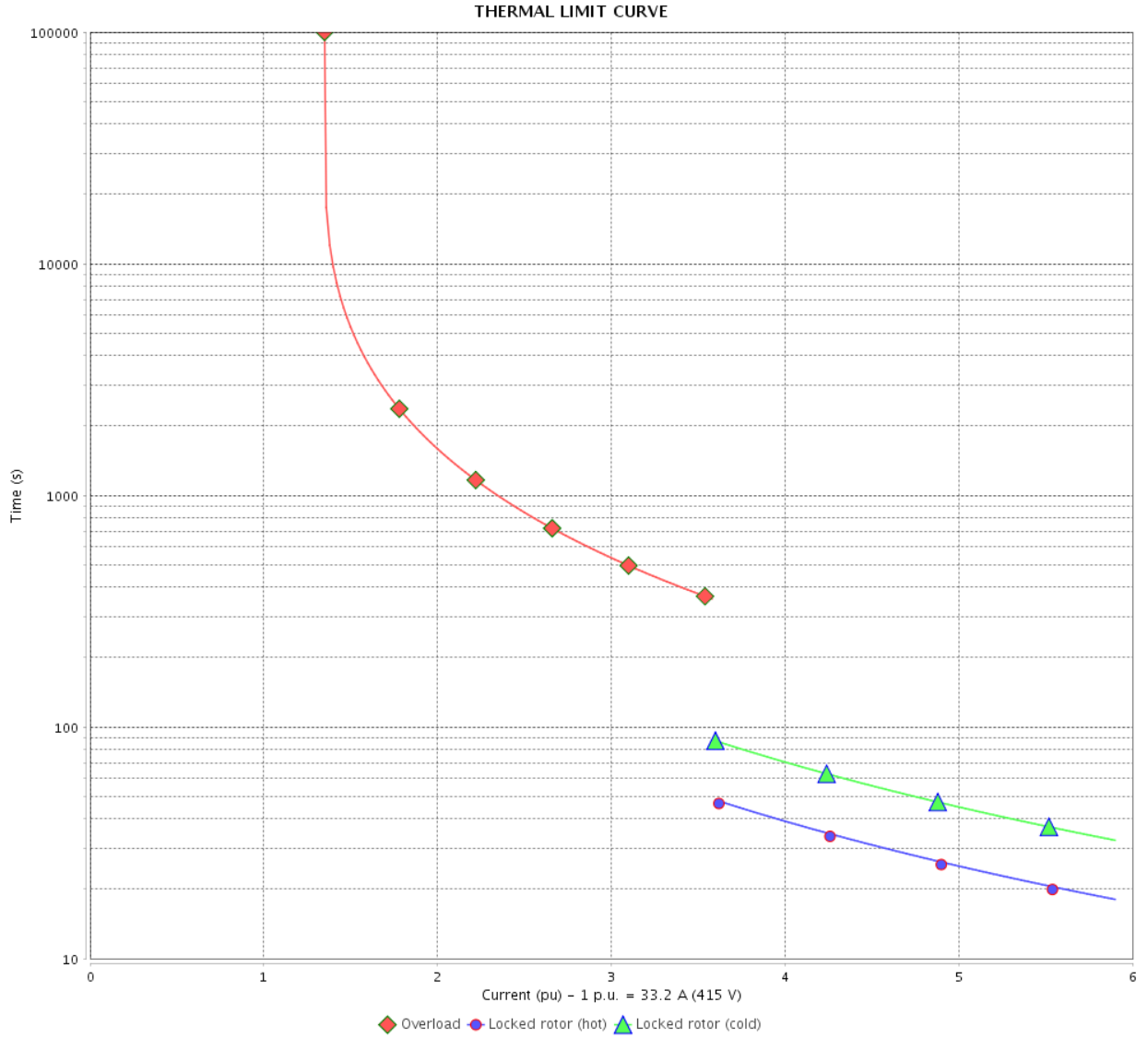

Rev.	Changes Summary	Performed	Checked	Date
Performed by		Page 29 / 36		Revision
Checked by				
Date				

VFD OPERATION CURVE

Three Phase Induction Motor - Squirrel Cage



Customer :

Product line : NEMA Premium Efficiency Three-Phase

Product code : 12447067

Catalog # : 02518ET3E284TC-W22

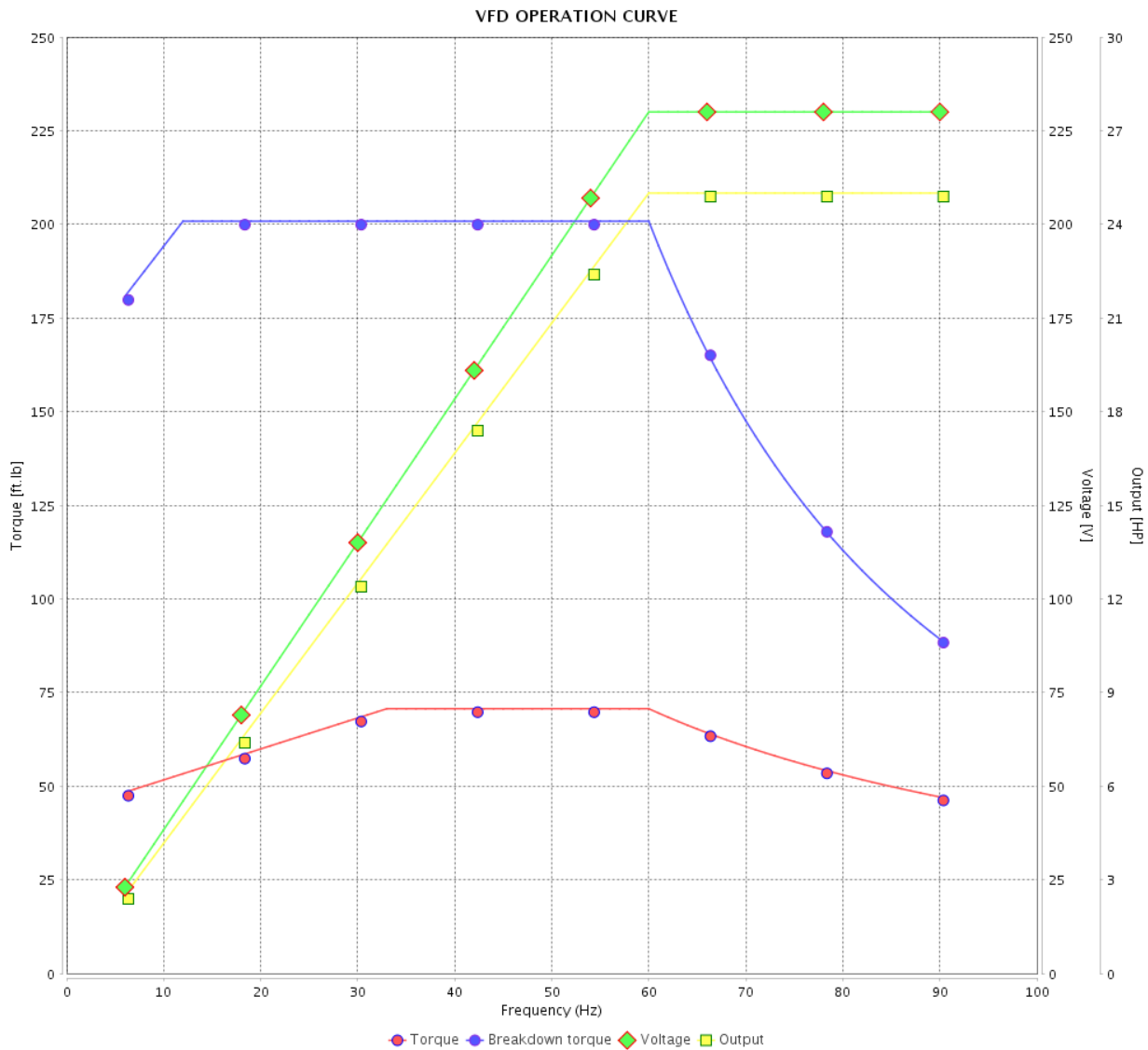

Performance : 230/460 V 60 Hz 4P

Rated current : 59.0/29.5 A
 LRC : 6.2
 Rated torque : 74.4 ft.lb
 Locked rotor torque : 240 %
 Breakdown torque : 270 %
 Rated speed : 1765 rpm

Moment of inertia (J) : 5.11 sq.ft.lb
 Duty cycle : Cont.(S1)
 Insulation class : F
 Service factor : 1.25
 Temperature rise : 80 K
 Design : B

Rev.	Changes Summary	Performed	Checked	Date
Performed by			Page 30 / 36	Revision
Checked by				
Date	14/04/2022			

VFD OPERATION CURVE

Three Phase Induction Motor - Squirrel Cage



Customer :

Product line : NEMA Premium Efficiency Three-Phase

Product code : 12447067

Catalog # : 02518ET3E284TC-W22

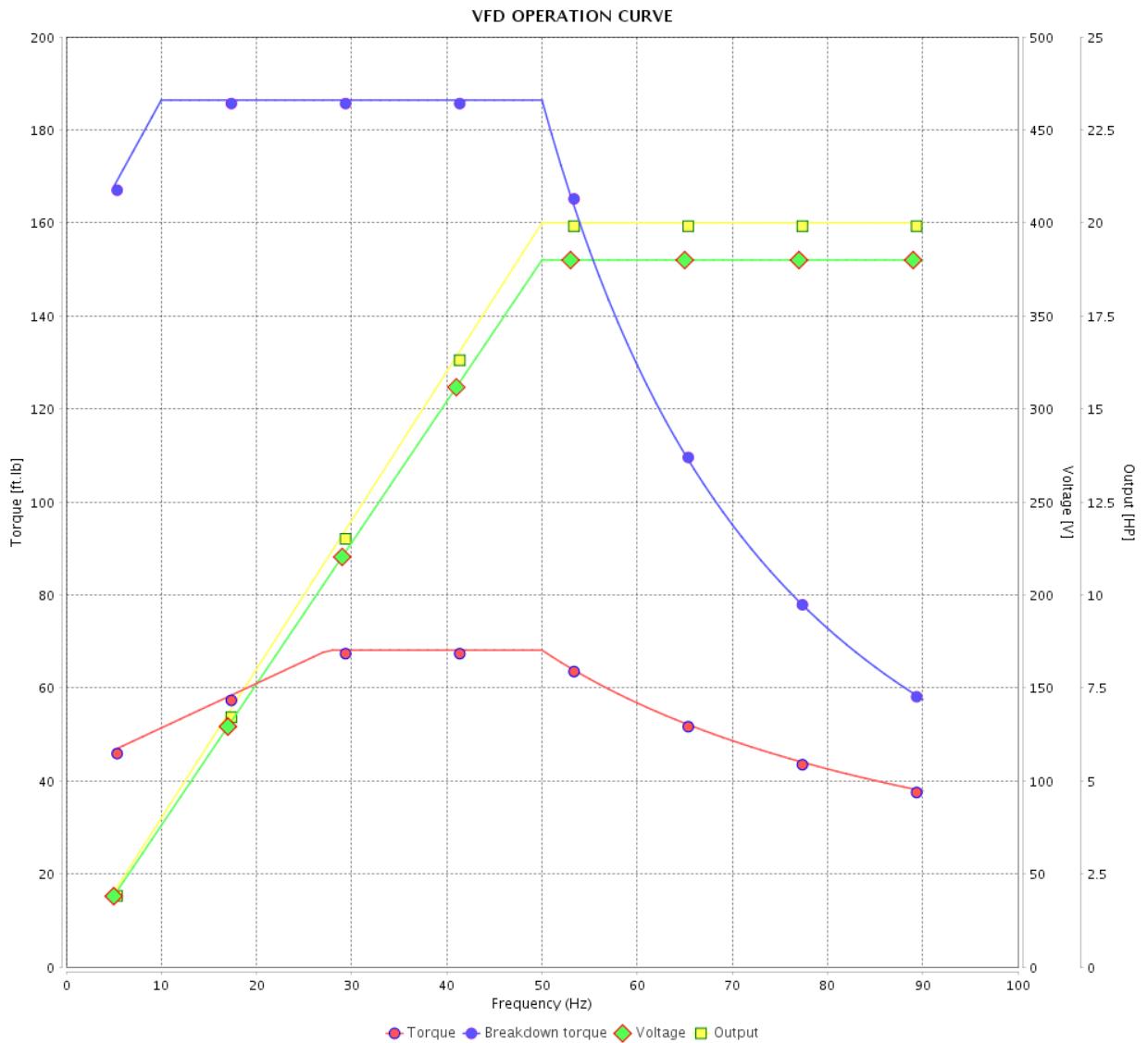

Performance : 380 V 50 Hz 4P IE3

Rated current : 29.1 A
 LRC : 6.0
 Rated torque : 71.7 ft.lb
 Locked rotor torque : 229 %
 Breakdown torque : 260 %
 Rated speed : 1465 rpm

Moment of inertia (J) : 5.11 sq.ft.lb
 Duty cycle : Cont.(S1)
 Insulation class : F
 Service factor : 1.00
 Temperature rise : 80 K
 Design : B

Rev.	Changes Summary	Performed	Checked	Date
Performed by		Page		Revision
Checked by		31 / 36		
Date		14/04/2022		

VFD OPERATION CURVE

Three Phase Induction Motor - Squirrel Cage



Customer :

Product line : NEMA Premium Efficiency Three-Phase

Product code : 12447067

Catalog # : 02518ET3E284TC-W22

VFD OPERATION CURVE

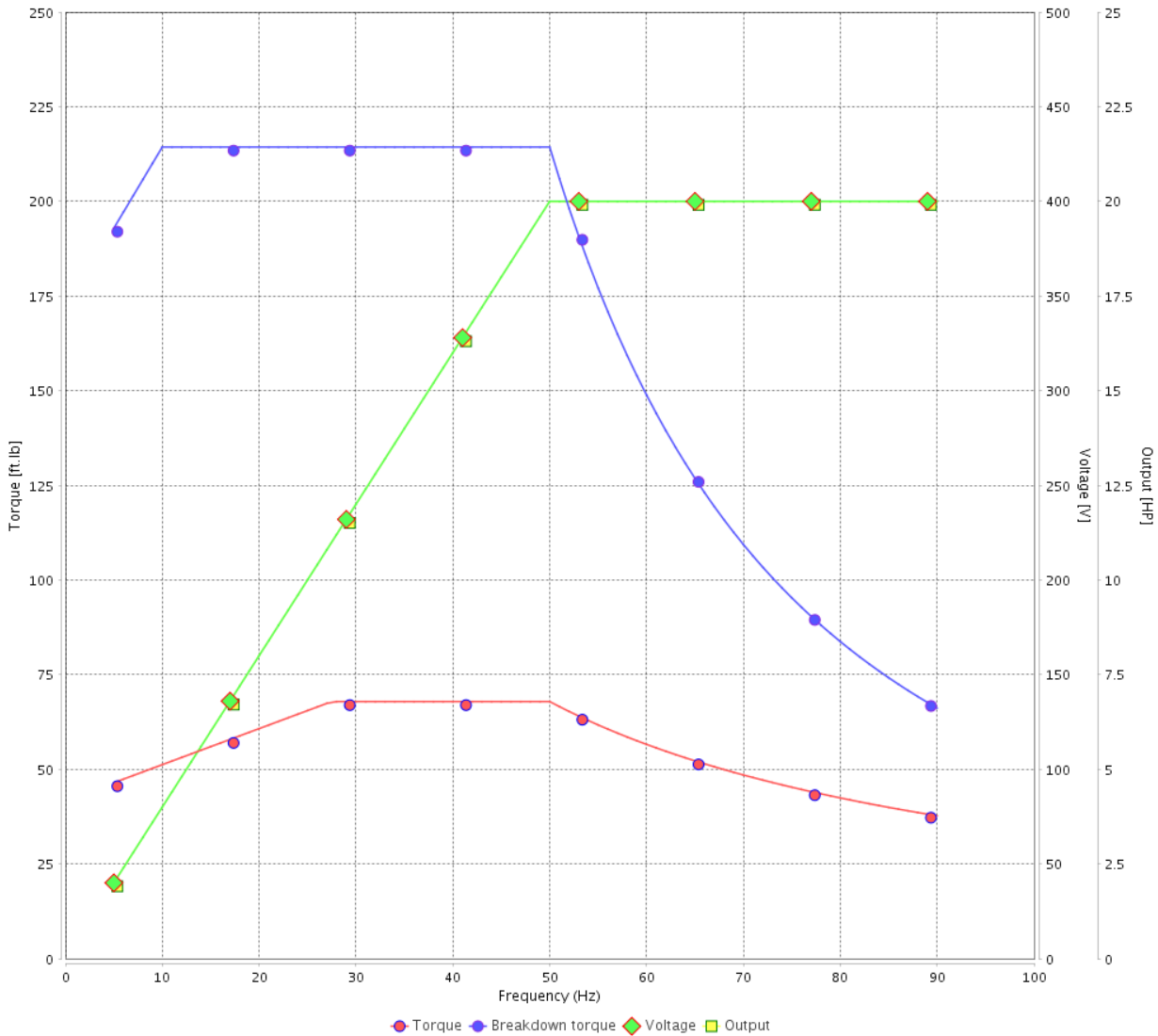

Performance : 400 V 50 Hz 4P IE3

Rated current : 28.2 A
 LRC : 6.7
 Rated torque : 71.4 ft.lb
 Locked rotor torque : 260 %
 Breakdown torque : 300 %
 Rated speed : 1470 rpm

Moment of inertia (J) : 5.11 sq.ft.lb
 Duty cycle : Cont.(S1)
 Insulation class : F
 Service factor : 1.00
 Temperature rise : 80 K
 Design : B

Rev.	Changes Summary	Performed	Checked	Date
Performed by			Page 32 / 36	Revision
Checked by				
Date	14/04/2022			

VFD OPERATION CURVE

Three Phase Induction Motor - Squirrel Cage



Customer : _____

Product line : NEMA Premium Efficiency Three-Phase

Product code : 12447067

Catalog # : 02518ET3E284TC-W22

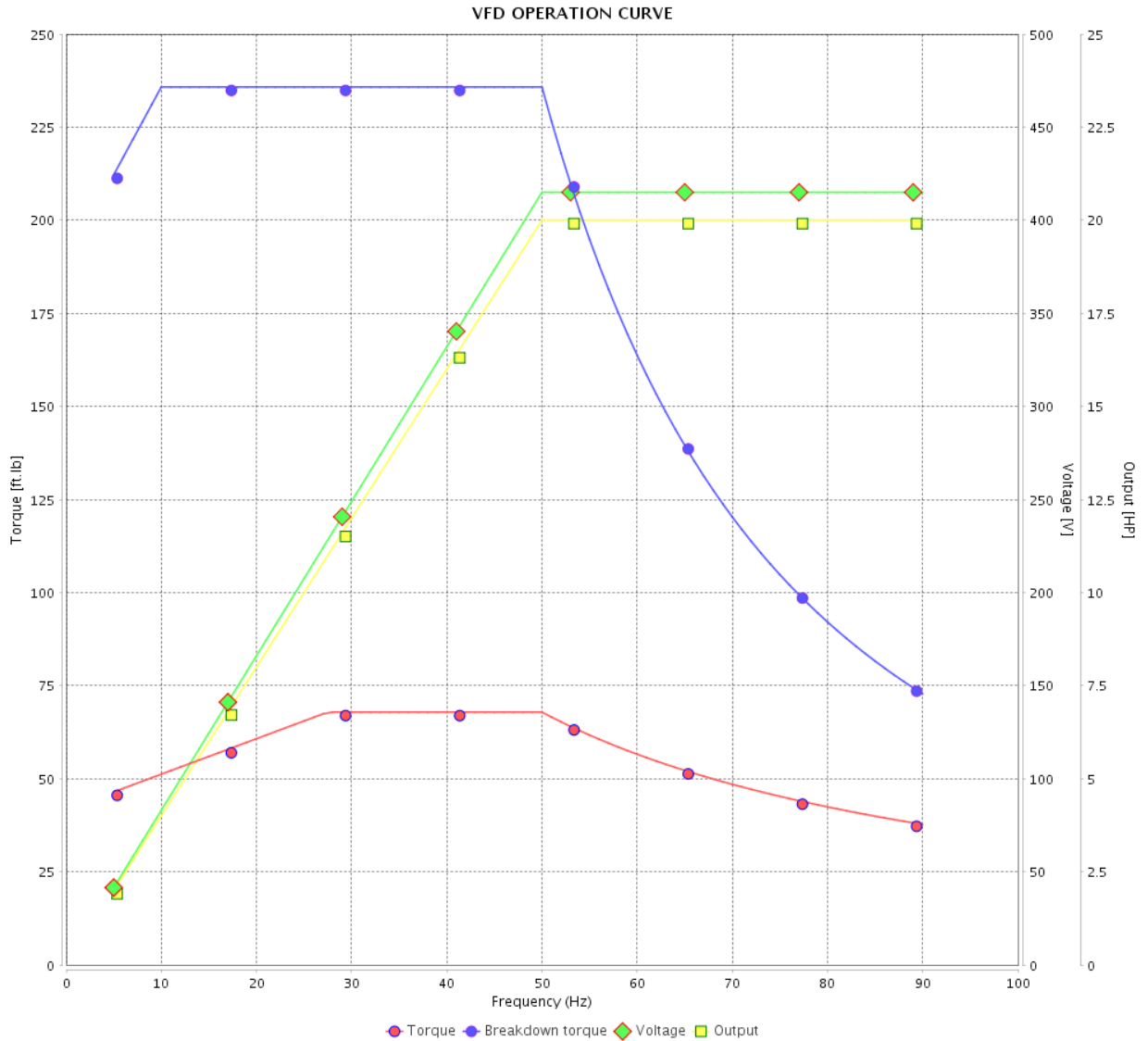

Performance : 415 V 50 Hz 4P IE3

Rated current : 27.5 A
 LRC : 7.2
 Rated torque : 71.4 ft.lb
 Locked rotor torque : 290 %
 Breakdown torque : 330 %
 Rated speed : 1470 rpm

Moment of inertia (J) : 5.11 sq.ft.lb
 Duty cycle : Cont.(S1)
 Insulation class : F
 Service factor : 1.00
 Temperature rise : 80 K
 Design : B

Rev.	Changes Summary	Performed	Checked	Date
Performed by		Page		Revision
Checked by		33 / 36		
Date		14/04/2022		

VFD OPERATION CURVE

Three Phase Induction Motor - Squirrel Cage



Customer :

Product line : NEMA Premium Efficiency Three-Phase

Product code : 12447067

Catalog # : 02518ET3E284TC-W22

VFD OPERATION CURVE

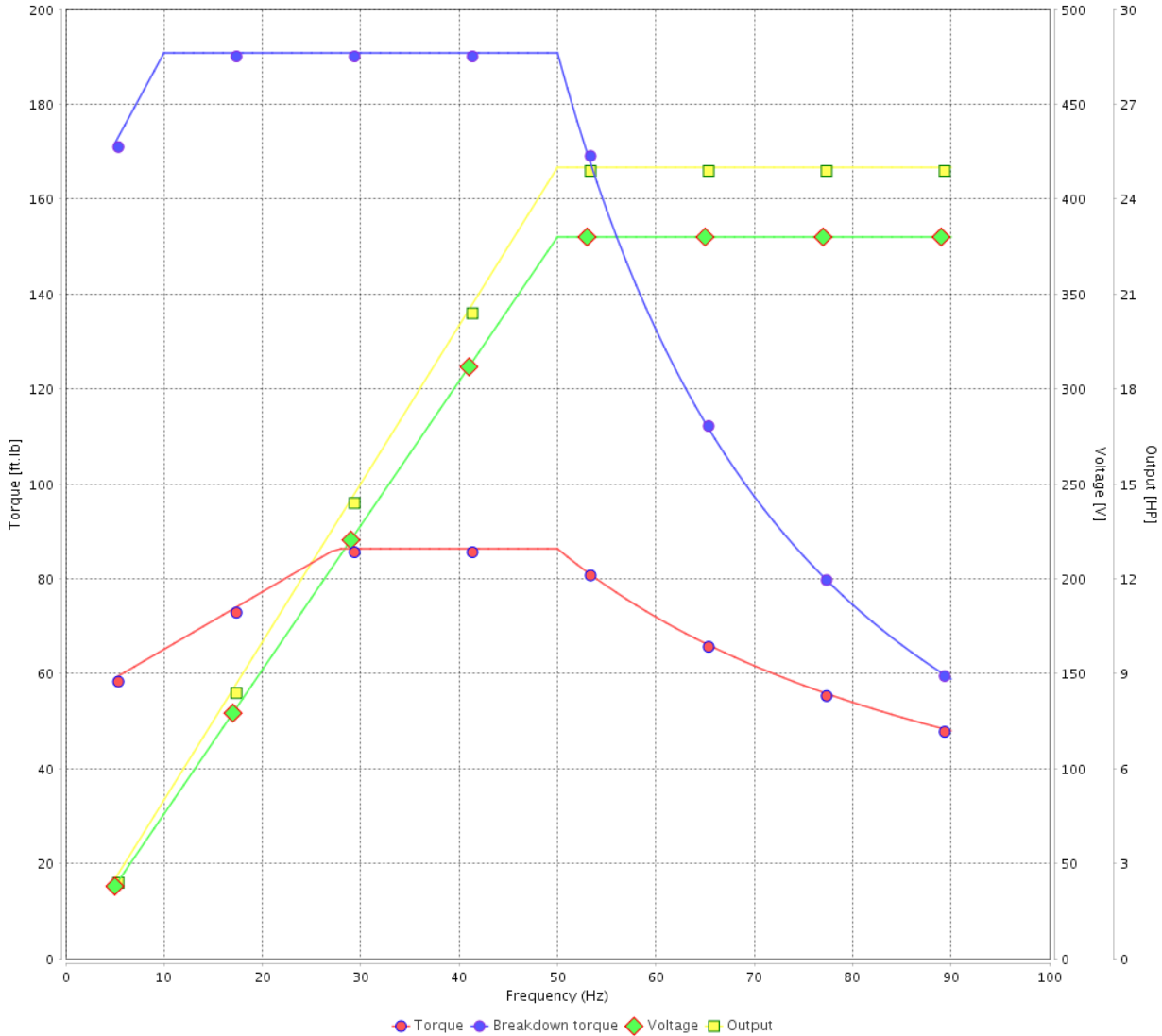

Performance : 380 V 50 Hz 4P IE2

Rated current	: 35.6 A	Moment of inertia (J)	: 5.11 sq.ft.lb
LRC	: 4.9	Duty cycle	: Cont.(S1)
Rated torque	: 90.9 ft.lb	Insulation class	: F
Locked rotor torque	: 180 %	Service factor	: 1.00
Breakdown torque	: 210 %	Temperature rise	: 105 K
Rated speed	: 1445 rpm	Design	: B

Rev.	Changes Summary	Performed	Checked	Date
Performed by			Page 34 / 36	Revision
Checked by				
Date	14/04/2022			

VFD OPERATION CURVE

Three Phase Induction Motor - Squirrel Cage



Customer :

Product line : NEMA Premium Efficiency Three-Phase

Product code : 12447067

Catalog # : 02518ET3E284TC-W22

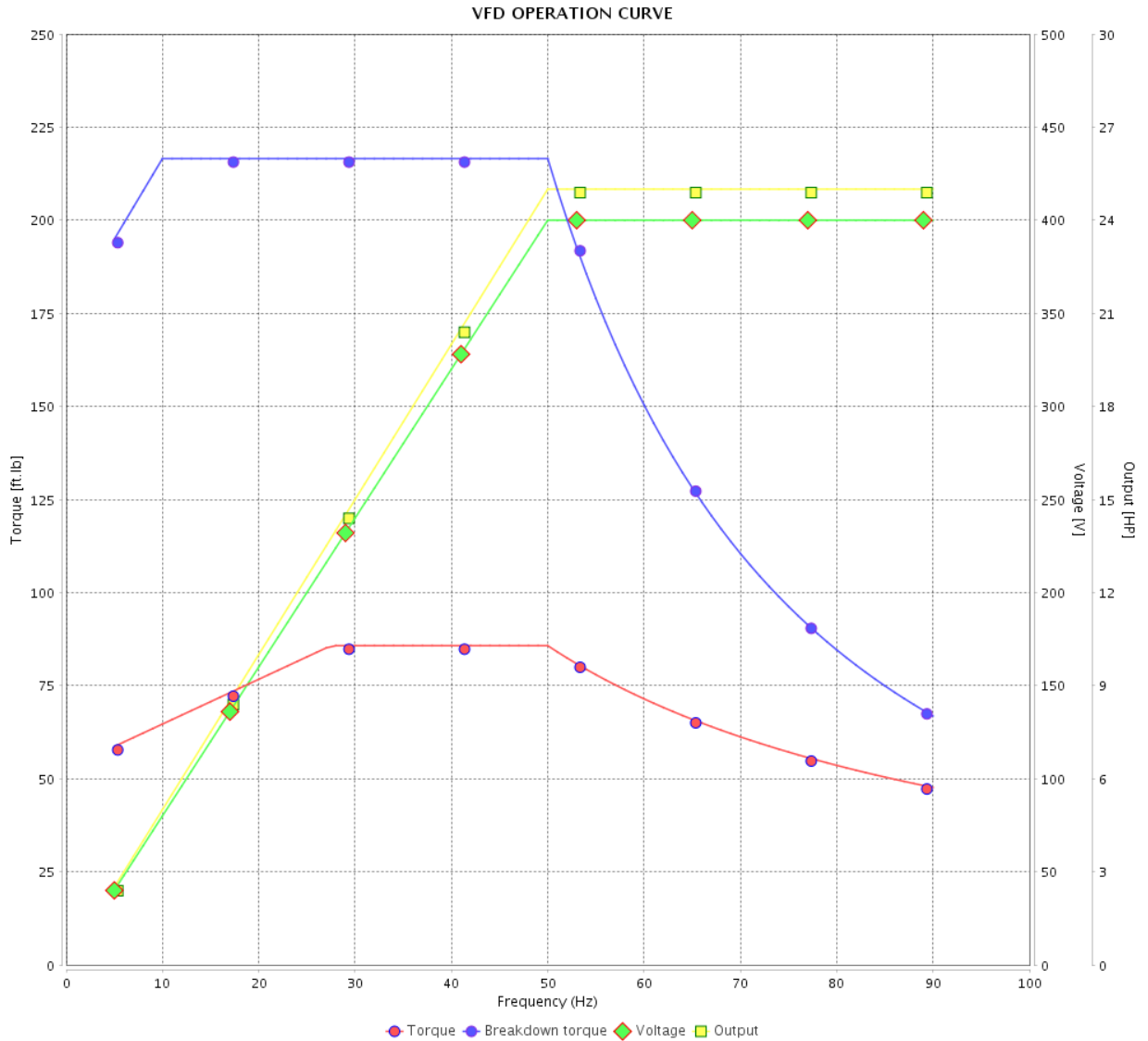

Performance : 400 V 50 Hz 4P IE2

Rated current : 34.0 A
 LRC : 5.5
 Rated torque : 90.2 ft.lb
 Locked rotor torque : 210 %
 Breakdown torque : 240 %
 Rated speed : 1455 rpm

Moment of inertia (J) : 5.11 sq.ft.lb
 Duty cycle : Cont.(S1)
 Insulation class : F
 Service factor : 1.00
 Temperature rise : 105 K
 Design : B

Rev.	Changes Summary	Performed	Checked	Date
Performed by		Page		Revision
Checked by		35 / 36		
Date		14/04/2022		

VFD OPERATION CURVE

Three Phase Induction Motor - Squirrel Cage



Customer :

Product line : NEMA Premium Efficiency Three-Phase

Product code : 12447067

Catalog # : 02518ET3E284TC-W22

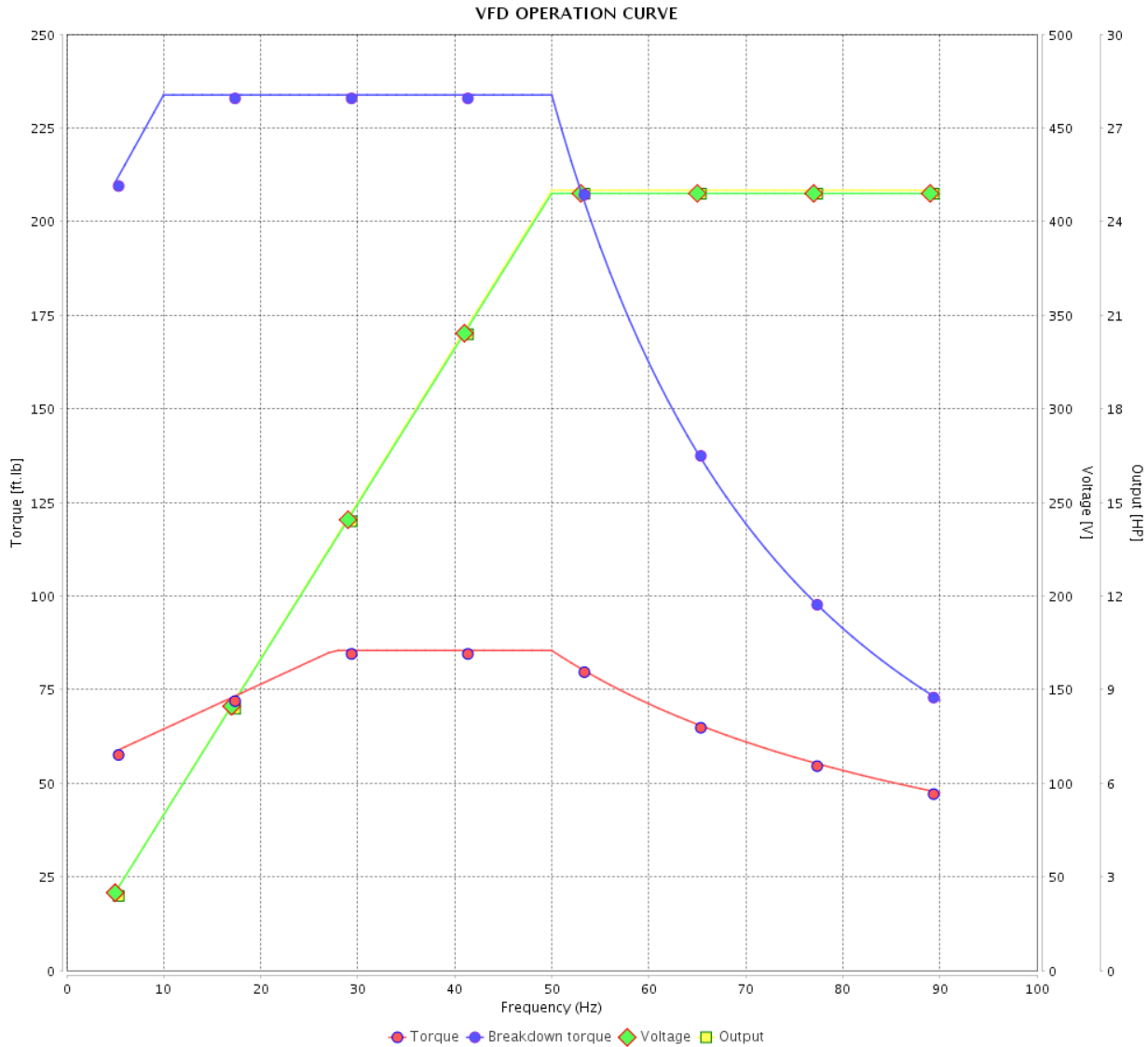

Performance : 415 V 50 Hz 4P IE2

Rated current	: 33.2 A	Moment of inertia (J)	: 5.11 sq.ft.lb
LRC	: 5.9	Duty cycle	: Cont.(S1)
Rated torque	: 89.9 ft.lb	Insulation class	: F
Locked rotor torque	: 229 %	Service factor	: 1.00
Breakdown torque	: 260 %	Temperature rise	: 80 K
Rated speed	: 1460 rpm	Design	: B

Rev.	Changes Summary	Performed	Checked	Date
Performed by			Page 36 / 36	Revision
Checked by				
Date	14/04/2022			

1 2 3 4 5 6

A

B

C

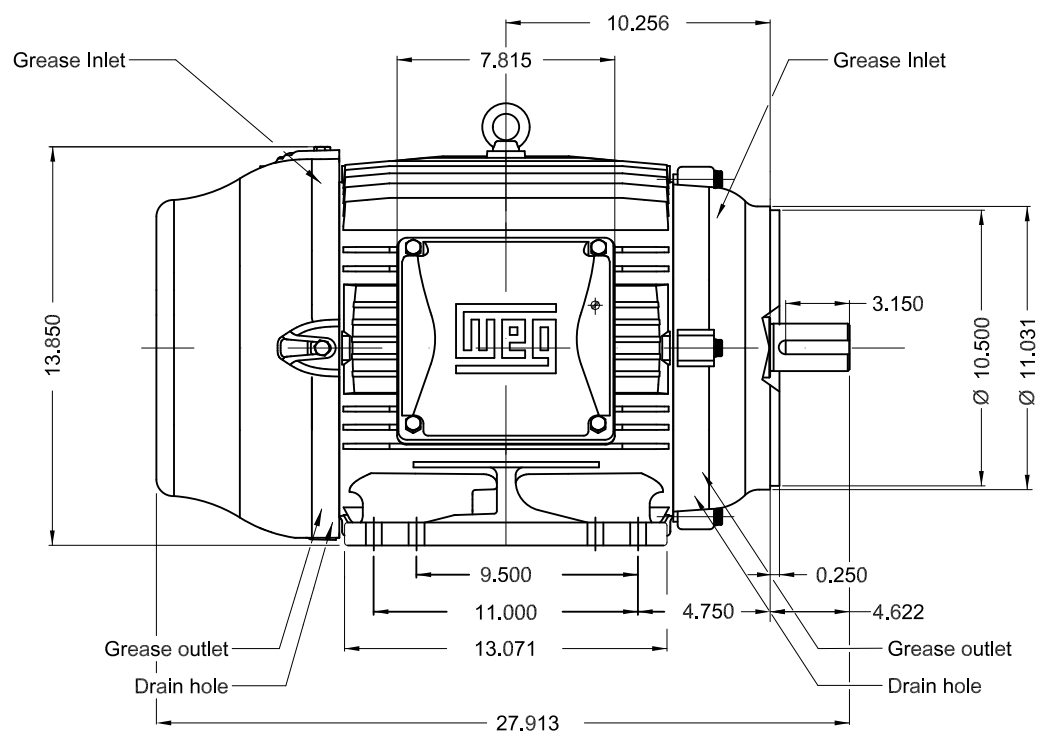
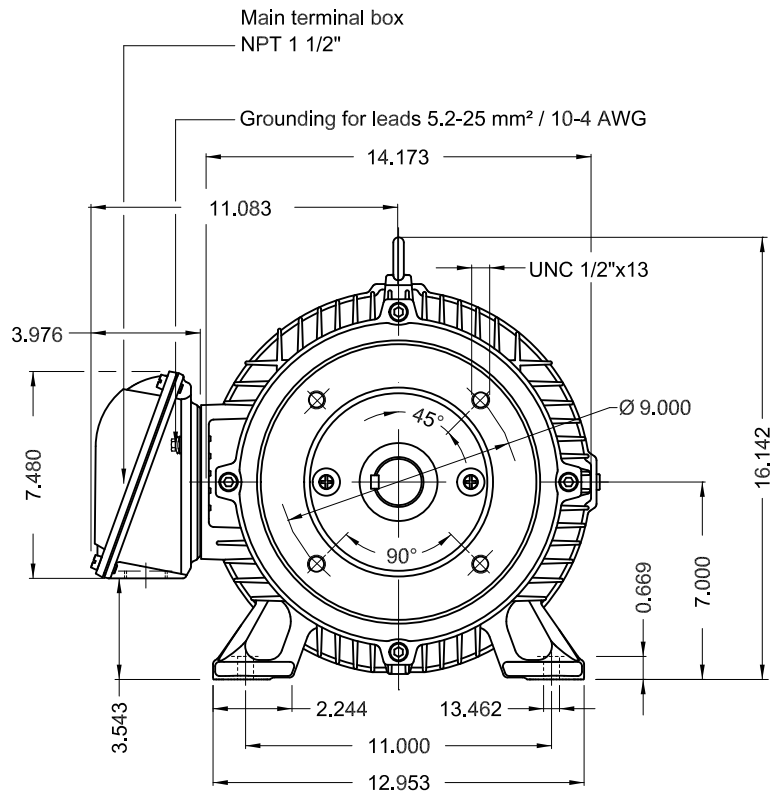

D

E

Without vertical jackscrews
 Color RAL 5009
 Painting plan 203A
 Mounting B34R(D)

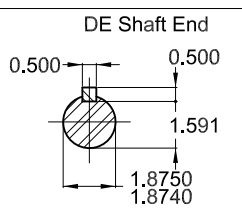

25 HP 04 Poles 60 Hz A

ECM	LOC	SUMMARY OF MODIFICATIONS	EXECUTED	CHECKED	RELEASED	DATE	VER
EXECUTED	PIRWBUSER	THREE PH. MOTOR W22 PREM. EFF.					
CHECKED		FRAME 284/6TC IP55 TEFC					
RELEASED							
REL DT.	WMO	Jaragua do Sul	Product Engineering	SHEET	1 / 1		

PREVIEW
 WDD

