

DATA SHEET

Three Phase Induction Motor - Squirrel Cage



Customer					
Product line		: W40 NEMA Premium Efficiency Three-Phase		Product code : 14503702 Catalog # : 02518OT3E284T-W40G	
Frame : 284T		Cooling method : IC01 - ODP			
Insulation class : F		Mounting : F-1			
Duty cycle : Cont.(S1)		Rotation ¹ : Both (CW and CCW)			
Ambient temperature : -20°C to +40°C		Starting method : Direct On Line			
Altitude : 1000 m.a.s.l.		Approx. weight ² : 352 lb			
Protection degree : IP23		Moment of inertia (J) : 3.71 sq.ft.lb			
Design : B					
Output [HP]	25	20	20	20	20
Poles	4	4	4	4	4
Frequency [Hz]	60	50	50	50	50
Rated voltage [V]	230/460	380	400	415	415
Rated current [A]	59.0/29.5	29.5	28.7	28.0	28.0
L. R. Amperes [A]	372/186	171	192	190	190
LRC [A]	6.3x(Code G)	5.8x(Code G)	6.7x(Code H)	6.8x(Code J)	6.8x(Code J)
No load current [A]	22.0/11.0	10.0	11.0	12.0	12.0
Rated speed [RPM]	1765	1465	1470	1475	1475
Slip [%]	1.94	2.33	2.00	1.67	1.67
Rated torque [ft.lb]	74.2	71.4	71.2	71.2	71.2
Locked rotor torque [%]	250	229	250	270	270
Breakdown torque [%]	270	250	290	300	300
Service factor	1.25	1.00	1.00	1.00	1.00
Temperature rise	80 K	80 K	80 K	80 K	80 K
Locked rotor time	64s (cold) 36s (hot)	70s (cold) 39s (hot)	64s (cold) 36s (hot)	61s (cold) 34s (hot)	61s (cold) 34s (hot)
Noise level ²	64.0 dB(A)				
Efficiency (%)	25%	92.8	91.5	91.5	91.5
	50%	93.0	91.7	91.7	91.7
	75%	93.6	92.1	92.1	92.1
	100%	93.6	92.1	92.1	92.1
Power Factor	25%	0.45	0.46	0.42	0.38
	50%	0.69	0.69	0.65	0.62
	75%	0.80	0.79	0.77	0.74
	100%	0.84	0.84	0.82	0.81
Bearing type	: Drive end : 6311 Z C3	: Non drive end : 6211 Z C3	Foundation loads		
Sealing	: Without	: Without	Max. traction		
	: Bearing Seal	: Bearing Seal	Max. compression		
Lubrication interval	: 20000 h	: 20000 h			
Lubricant amount	: 18 g	: 11 g			
Lubricant type	: Mobil Polyrex EM				
Notes USABLE @208V 65.2A SF 1.15 SFA 75.0A					
This revision replaces and cancel the previous one, which must be eliminated. (1) Looking the motor from the shaft end. (2) Measured at 1m and with tolerance of +3dB(A). (3) Approximate weight subject to changes after manufacturing process. (4) At 100% of full load.			These are average values based on tests with sinusoidal power supply, subject to the tolerances stipulated in NEMA MG-1.		
Rev.	Changes Summary		Performed	Checked	Date
Performed by					
Checked by				Page	Revision
Date	13/04/2022			1 / 21	

TORQUE AND CURRENT VS SPEED CURVE

Three Phase Induction Motor - Squirrel Cage



Customer :

Product line : W40 NEMA Premium Efficiency
Three-Phase

Product code : 14503702

Catalog # : 02518OT3E284T-W40G

TORQUE AND CURRENT VS SPEED CURVE

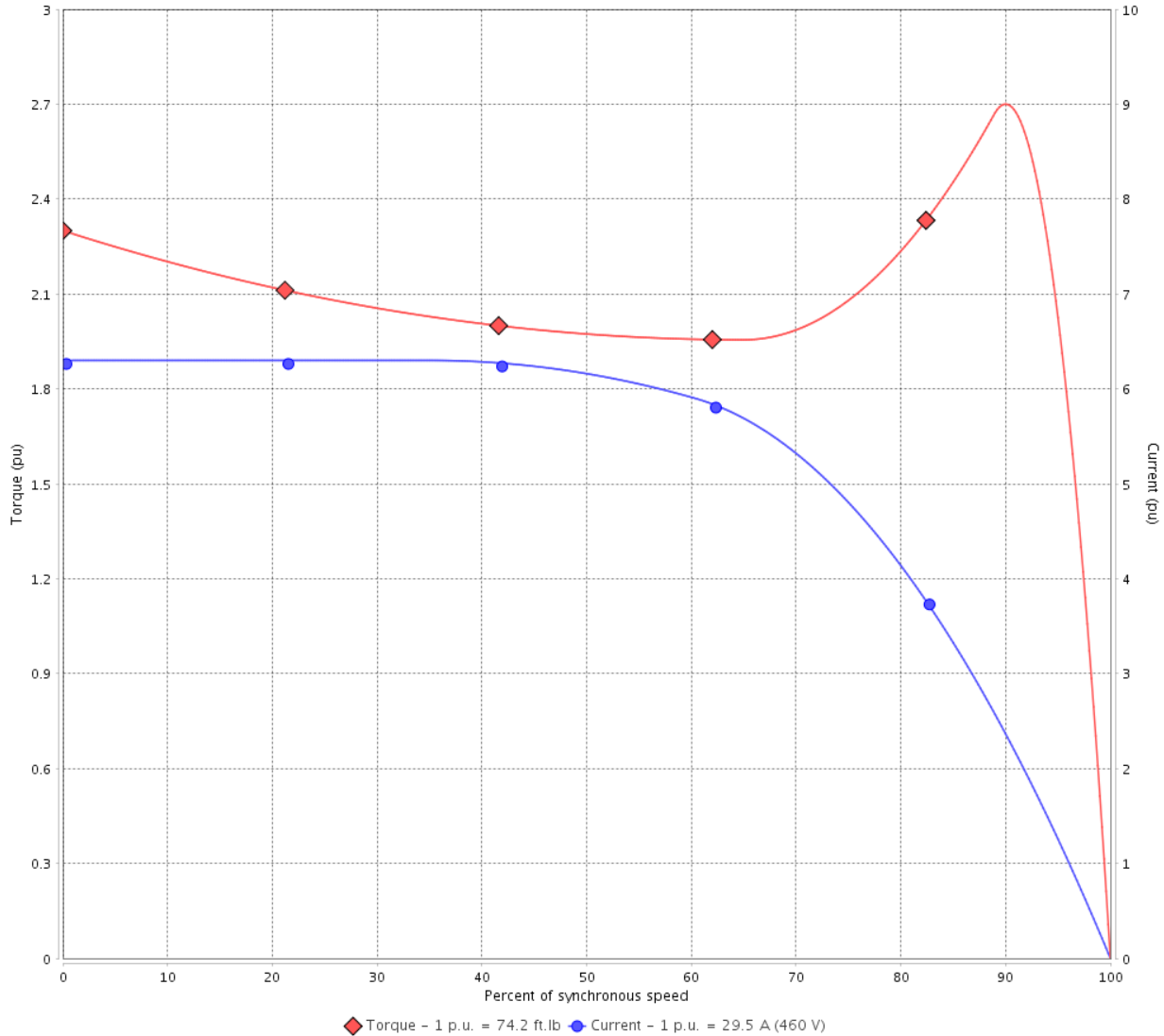

Performance : 230/460 V 60 Hz 4P

Rated current	: 59.0/29.5 A	Moment of inertia (J)	: 3.71 sq.ft.lb
LRC	: 6.3	Duty cycle	: Cont.(S1)
Rated torque	: 74.2 ft.lb	Insulation class	: F
Locked rotor torque	: 250 %	Service factor	: 1.25
Breakdown torque	: 270 %	Temperature rise	: 80 K
Rated speed	: 1765 rpm	Design	: B

Locked rotor time : 64s (cold) 36s (hot)

Rev.	Changes Summary	Performed	Checked	Date
Performed by			Page 2 / 21	Revision
Checked by				
Date	13/04/2022			

TORQUE AND CURRENT VS SPEED CURVE



Three Phase Induction Motor - Squirrel Cage

Customer :

Product line : W40 NEMA Premium Efficiency
Three-Phase

Product code : 14503702

Catalog # : 02518OT3E284T-W40G

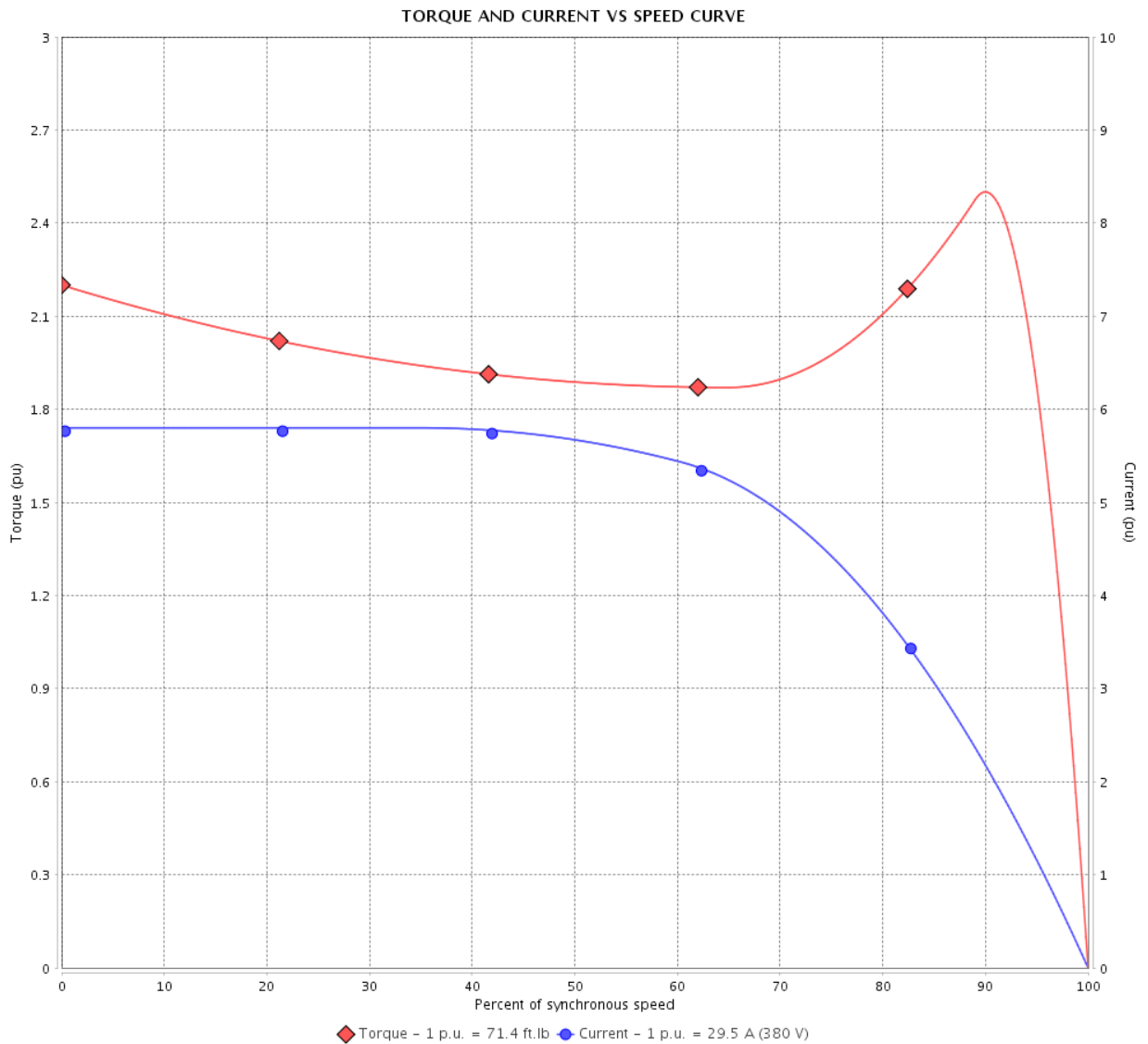

Performance : 380 V 50 Hz 4P IE3

Rated current	: 29.5 A	Moment of inertia (J)	: 3.71 sq.ft.lb
LRC	: 5.8	Duty cycle	: Cont.(S1)
Rated torque	: 71.4 ft.lb	Insulation class	: F
Locked rotor torque	: 229 %	Service factor	: 1.00
Breakdown torque	: 250 %	Temperature rise	: 80 K
Rated speed	: 1465 rpm	Design	: B

Locked rotor time : 70s (cold) 39s (hot)

Rev.	Changes Summary	Performed	Checked	Date
Performed by			Page 3 / 21	Revision
Checked by				
Date	13/04/2022			

TORQUE AND CURRENT VS SPEED CURVE

Three Phase Induction Motor - Squirrel Cage



Customer :

Product line : W40 NEMA Premium Efficiency
Three-Phase

Product code : 14503702

Catalog # : 02518OT3E284T-W40G

TORQUE AND CURRENT VS SPEED CURVE

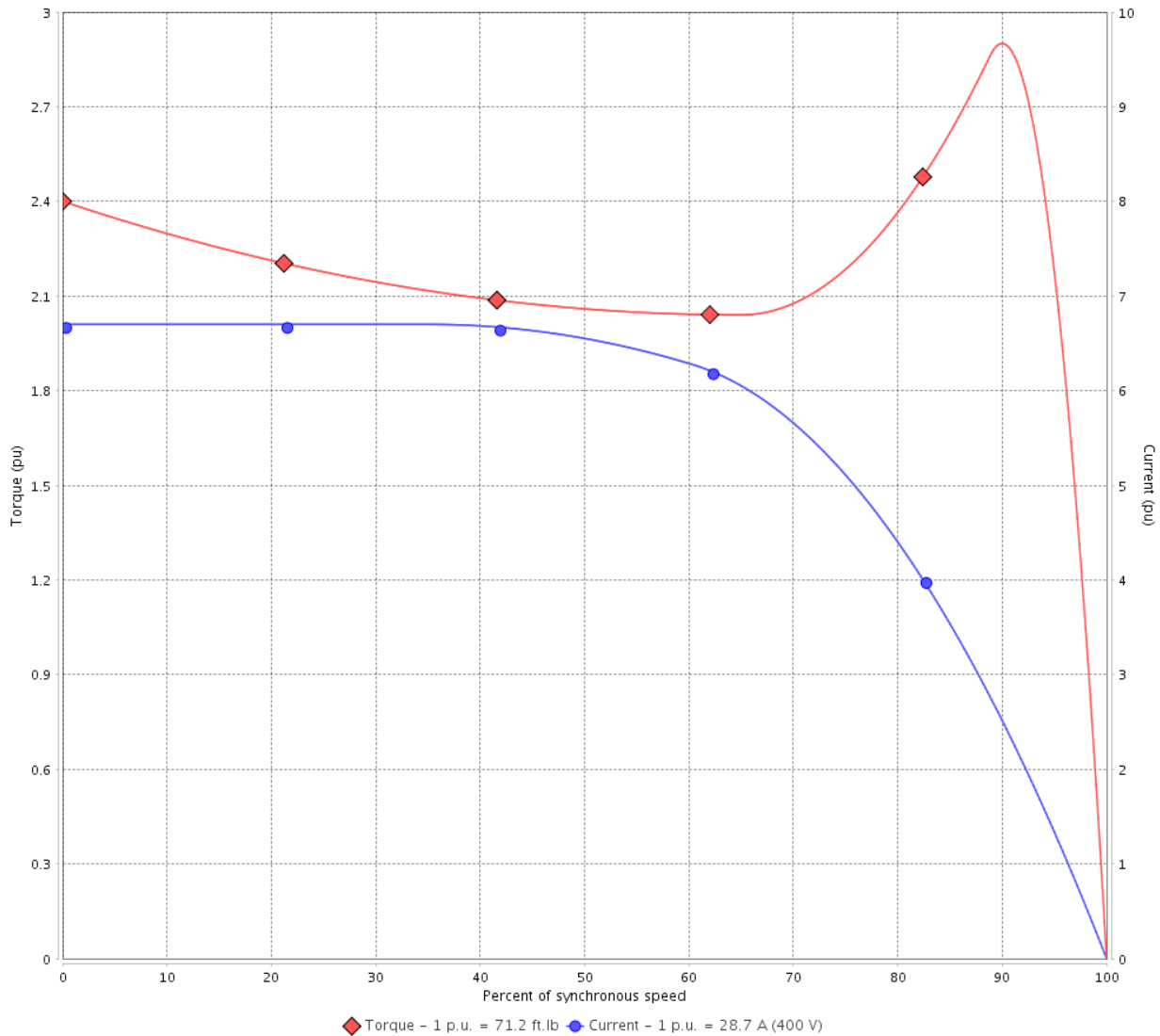

Performance : 400 V 50 Hz 4P IE3

Rated current	: 28.7 A	Moment of inertia (J)	: 3.71 sq.ft.lb
LRC	: 6.7	Duty cycle	: Cont.(S1)
Rated torque	: 71.2 ft.lb	Insulation class	: F
Locked rotor torque	: 250 %	Service factor	: 1.00
Breakdown torque	: 290 %	Temperature rise	: 80 K
Rated speed	: 1470 rpm	Design	: B

Locked rotor time : 64s (cold) 36s (hot)

Rev.	Changes Summary	Performed	Checked	Date
Performed by			Page 4 / 21	Revision
Checked by				
Date	13/04/2022			

TORQUE AND CURRENT VS SPEED CURVE



Three Phase Induction Motor - Squirrel Cage

Customer :

Product line : W40 NEMA Premium Efficiency
Three-Phase

Product code : 14503702

Catalog # : 02518OT3E284T-W40G

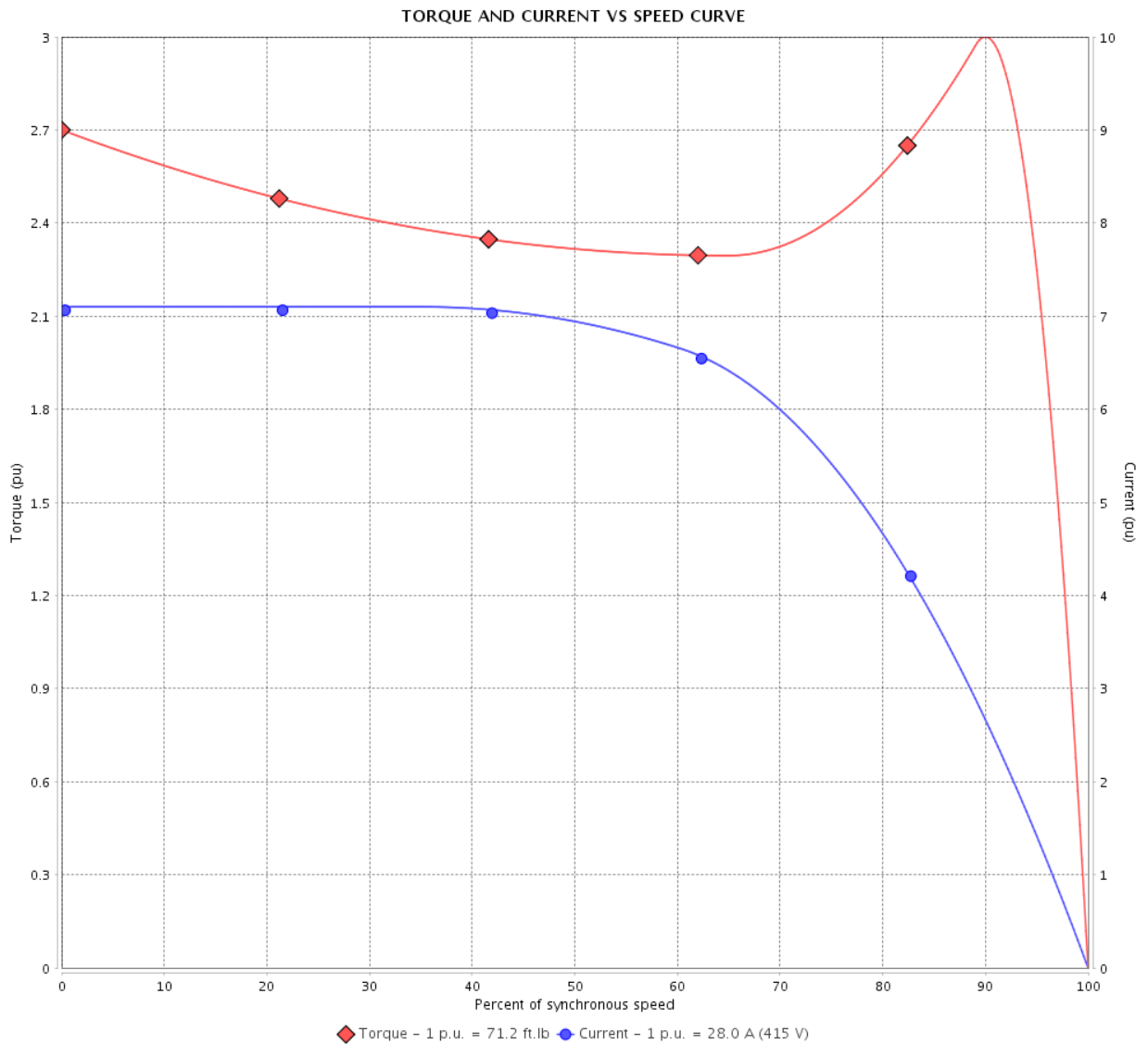

Performance : 415 V 50 Hz 4P IE3

Rated current	: 28.0 A	Moment of inertia (J)	: 3.71 sq.ft.lb
LRC	: 6.8	Duty cycle	: Cont.(S1)
Rated torque	: 71.2 ft.lb	Insulation class	: F
Locked rotor torque	: 270 %	Service factor	: 1.00
Breakdown torque	: 300 %	Temperature rise	: 80 K
Rated speed	: 1475 rpm	Design	: B

Locked rotor time : 61s (cold) 34s (hot)

Rev.	Changes Summary	Performed	Checked	Date
Performed by			Page 5 / 21	Revision
Checked by				
Date	13/04/2022			

LOAD PERFORMANCE CURVE

Three Phase Induction Motor - Squirrel Cage



Customer :

Product line : W40 NEMA Premium Efficiency Three-Phase

Product code : 14503702

Catalog # : 02518OT3E284T-W40G

LOAD PERFORMANCE CURVE

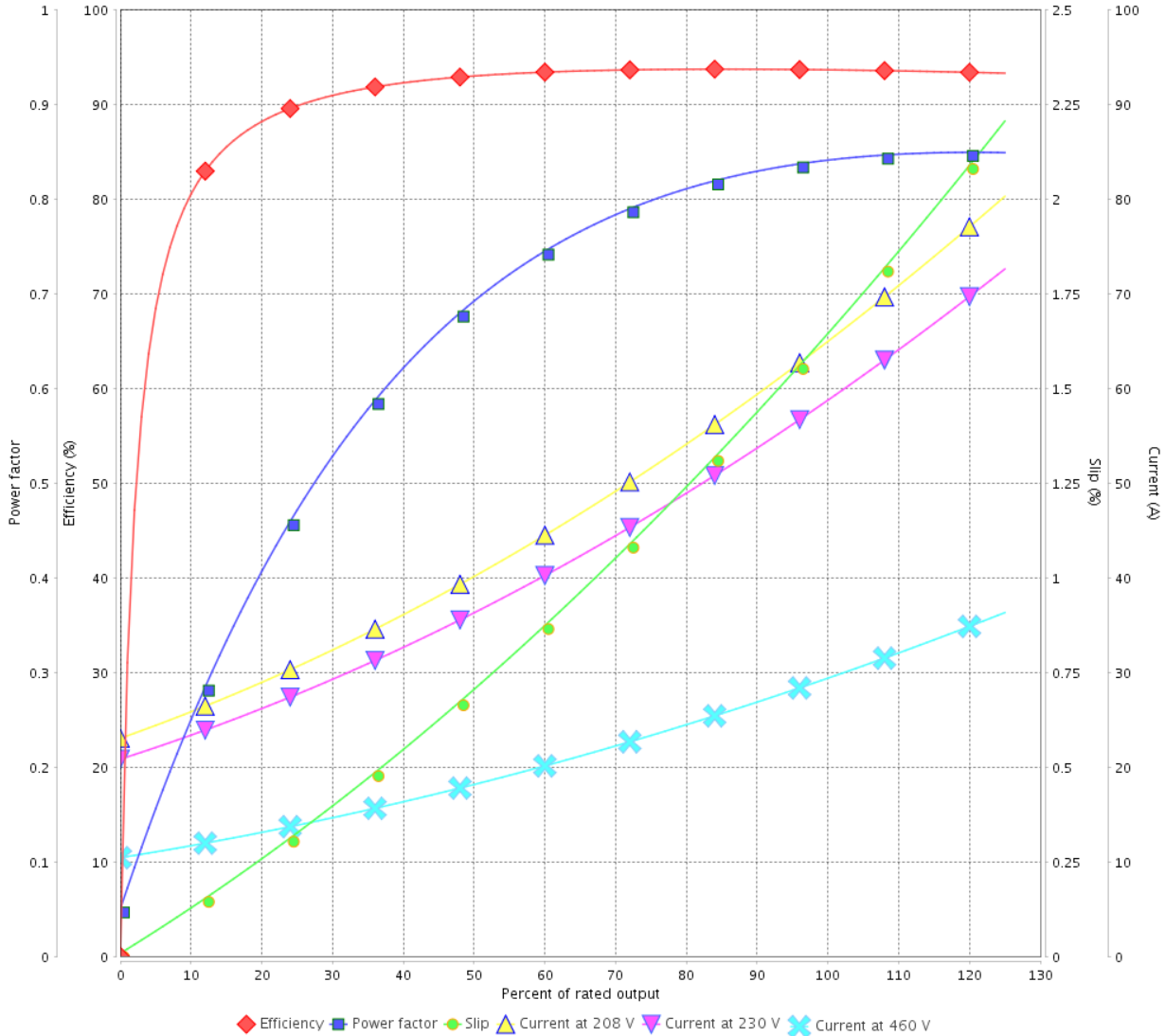

Performance : 230/460 V 60 Hz 4P

Rated current : 59.0/29.5 A
 LRC : 6.3
 Rated torque : 74.2 ft.lb
 Locked rotor torque : 250 %
 Breakdown torque : 270 %
 Rated speed : 1765 rpm

Moment of inertia (J) : 3.71 sq.ft.lb
 Duty cycle : Cont.(S1)
 Insulation class : F
 Service factor : 1.25
 Temperature rise : 80 K
 Design : B

Rev.	Changes Summary	Performed	Checked	Date
Performed by			Page 6 / 21	Revision
Checked by				
Date	13/04/2022			

LOAD PERFORMANCE CURVE

Three Phase Induction Motor - Squirrel Cage



Customer :

Product line : W40 NEMA Premium Efficiency
Three-Phase

Product code : 14503702

Catalog # : 02518OT3E284T-W40G

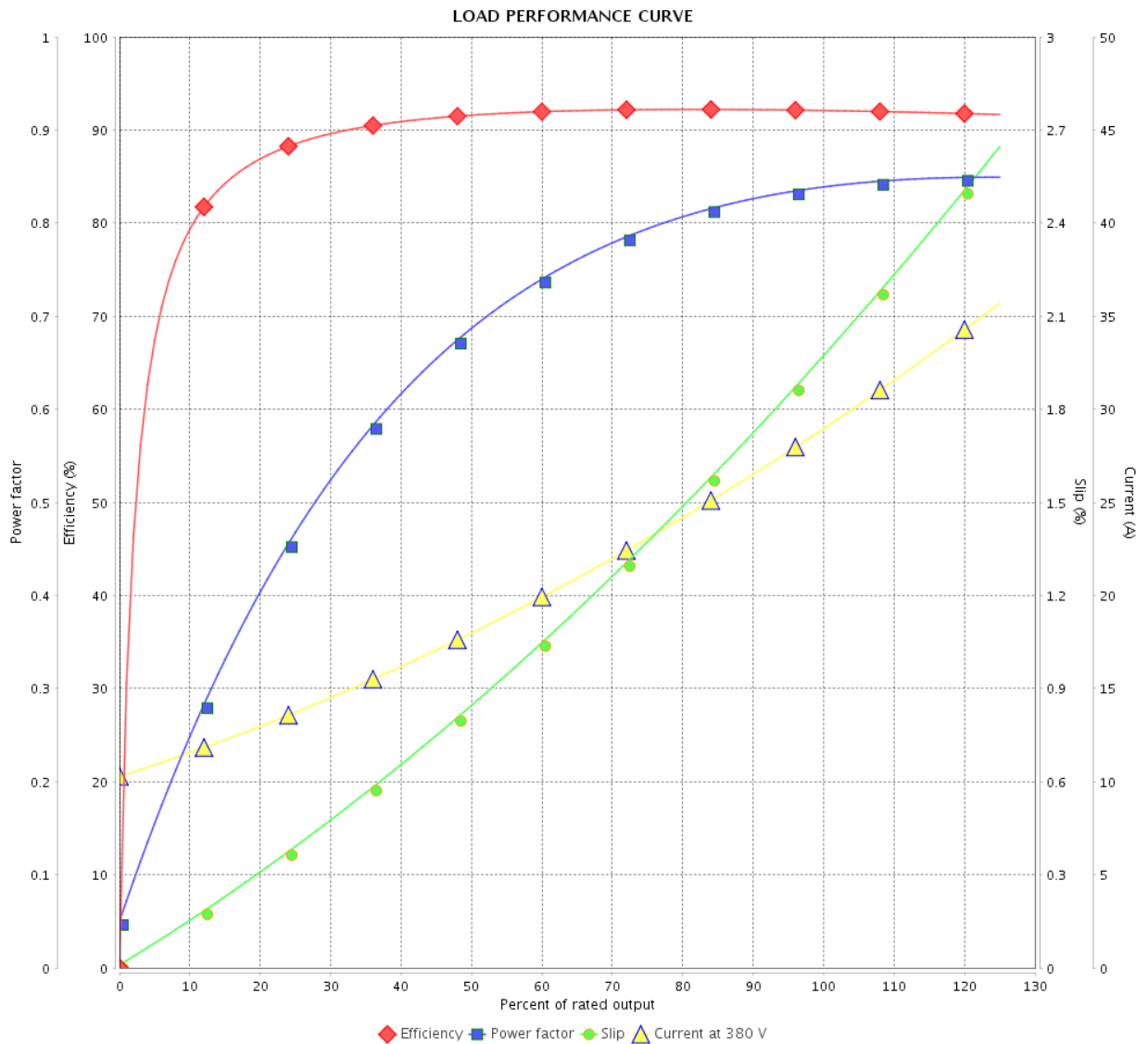

Performance : 380 V 50 Hz 4P IE3

Rated current : 29.5 A
 LRC : 5.8
 Rated torque : 71.4 ft.lb
 Locked rotor torque : 229 %
 Breakdown torque : 250 %
 Rated speed : 1465 rpm

Moment of inertia (J) : 3.71 sq.ft.lb
 Duty cycle : Cont.(S1)
 Insulation class : F
 Service factor : 1.00
 Temperature rise : 80 K
 Design : B

Rev.	Changes Summary	Performed	Checked	Date
Performed by				
Checked by				
Date				
		Page	Revision	
		7 / 21		

LOAD PERFORMANCE CURVE

Three Phase Induction Motor - Squirrel Cage



Customer : _____

Product line : W40 NEMA Premium Efficiency
Three-Phase

Product code : 14503702

Catalog # : 02518OT3E284T-W40G

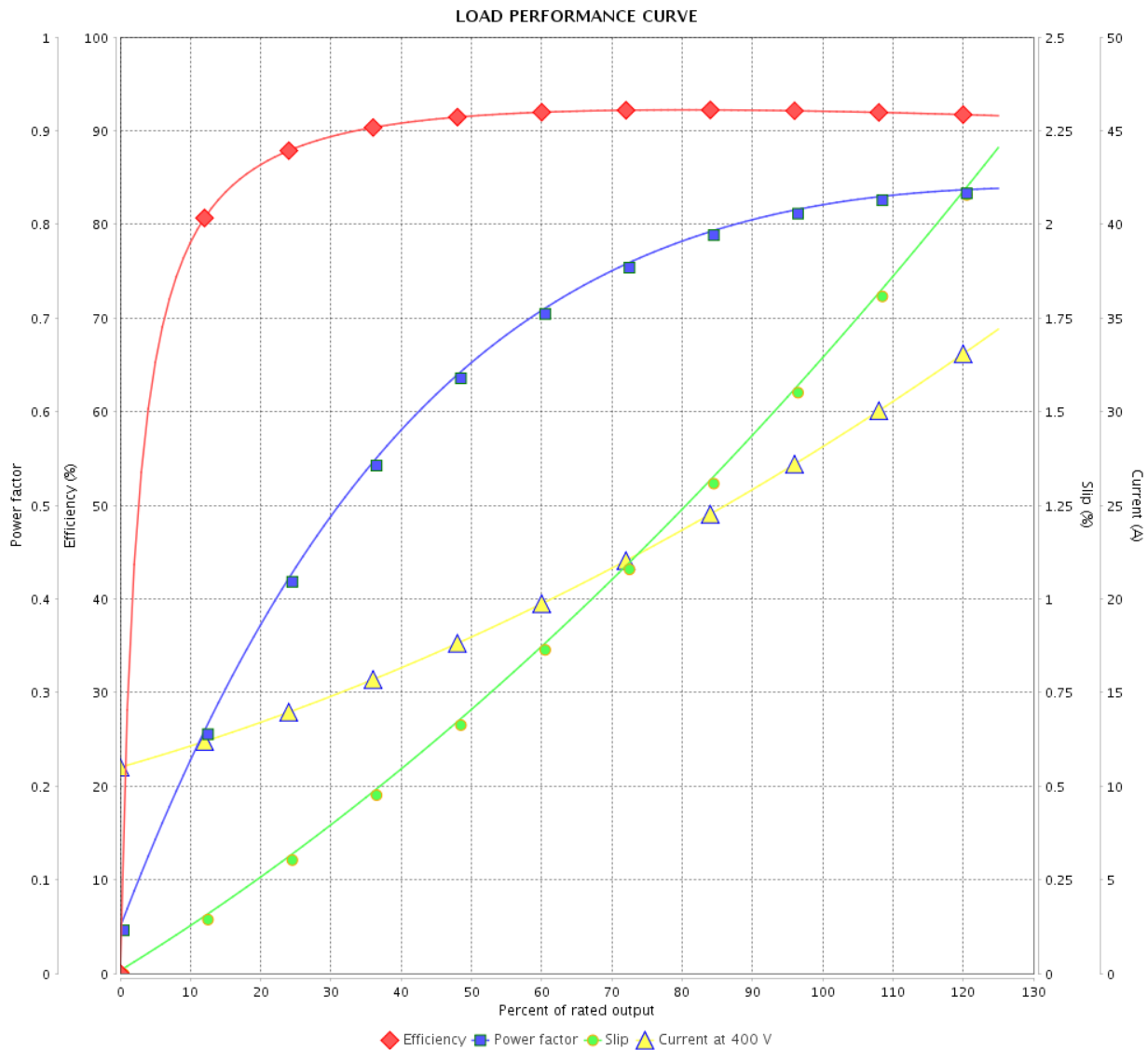

Performance : 400 V 50 Hz 4P IE3

Rated current : 28.7 A
LRC : 6.7
Rated torque : 71.2 ft.lb
Locked rotor torque : 250 %
Breakdown torque : 290 %
Rated speed : 1470 rpm

Moment of inertia (J) : 3.71 sq.ft.lb
Duty cycle : Cont.(S1)
Insulation class : F
Service factor : 1.00
Temperature rise : 80 K
Design : B

Rev.	Changes Summary	Performed	Checked	Date
Performed by			Page 8 / 21	Revision
Checked by				
Date	13/04/2022			

LOAD PERFORMANCE CURVE

Three Phase Induction Motor - Squirrel Cage



Customer : _____

Product line : W40 NEMA Premium Efficiency
Three-Phase

Product code : 14503702

Catalog # : 025180T3E284T-W40G

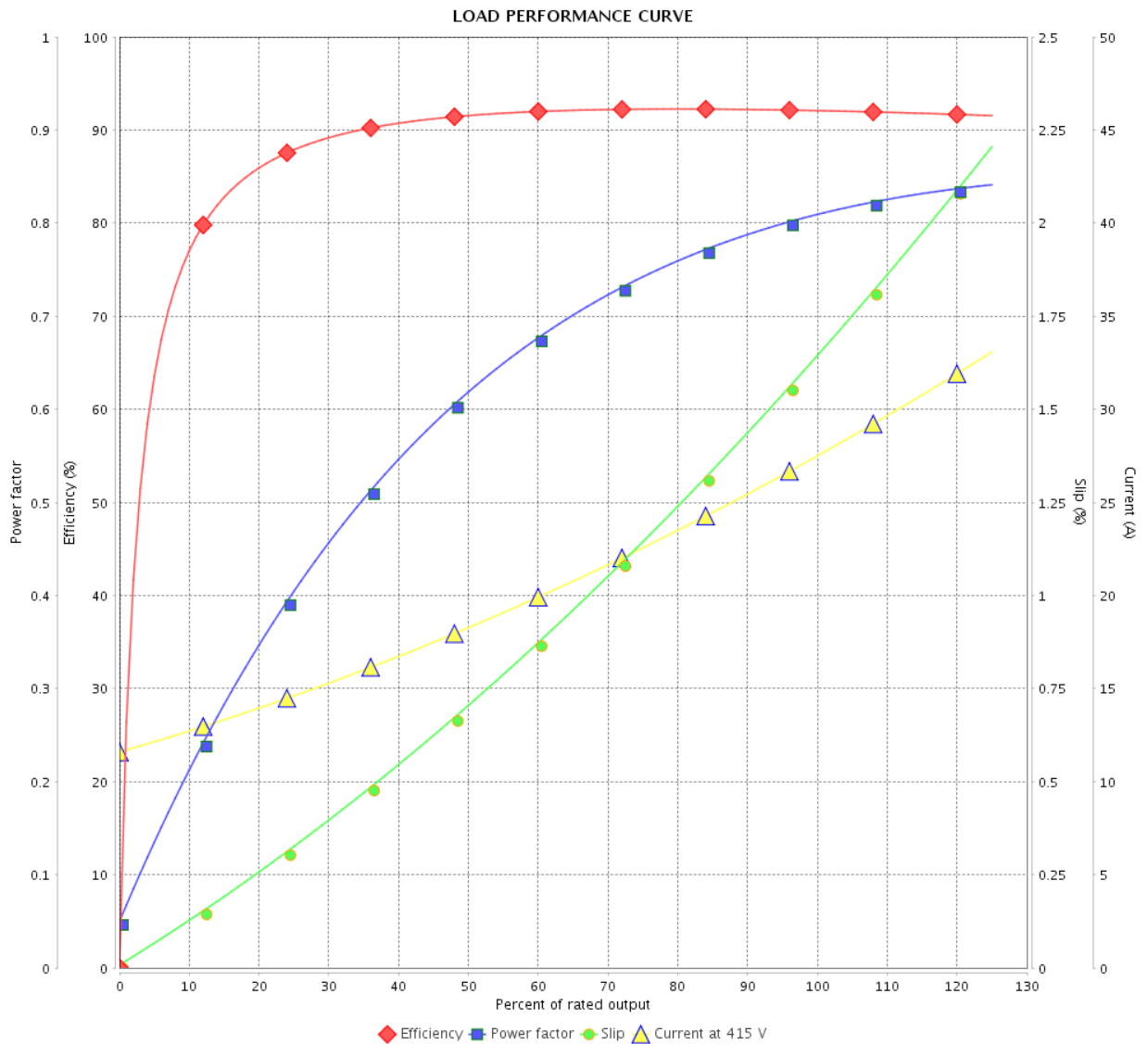

Performance : 415 V 50 Hz 4P IE3

Rated current : 28.0 A
 LRC : 6.8
 Rated torque : 71.2 ft.lb
 Locked rotor torque : 270 %
 Breakdown torque : 300 %
 Rated speed : 1475 rpm

Moment of inertia (J) : 3.71 sq.ft.lb
 Duty cycle : Cont.(S1)
 Insulation class : F
 Service factor : 1.00
 Temperature rise : 80 K
 Design : B

Rev.	Changes Summary	Performed	Checked	Date
Performed by			Page	Revision
Checked by				
Date				

THERMAL LIMIT CURVE



Three Phase Induction Motor - Squirrel Cage

Customer :

Product line : W40 NEMA Premium Efficiency
Three-Phase

Product code : 14503702

Catalog # : 02518OT3E284T-W40G

Performance : 230/460 V 60 Hz 4P

Rated current : 59.0/29.5 A
LRC : 6.3
Rated torque : 74.2 ft.lb
Locked rotor torque : 250 %
Breakdown torque : 270 %
Rated speed : 1765 rpm

Moment of inertia (J) : 3.71 sq.ft.lb
Duty cycle : Cont.(S1)
Insulation class : F
Service factor : 1.25
Temperature rise : 80 K
Design : B

Heating constant

Cooling constant

Rev.	Changes Summary	Performed	Checked	Date
Performed by				
Checked by			Page	Revision
Date	13/04/2022		10 / 21	

THERMAL LIMIT CURVE

Three Phase Induction Motor - Squirrel Cage



Customer : _____

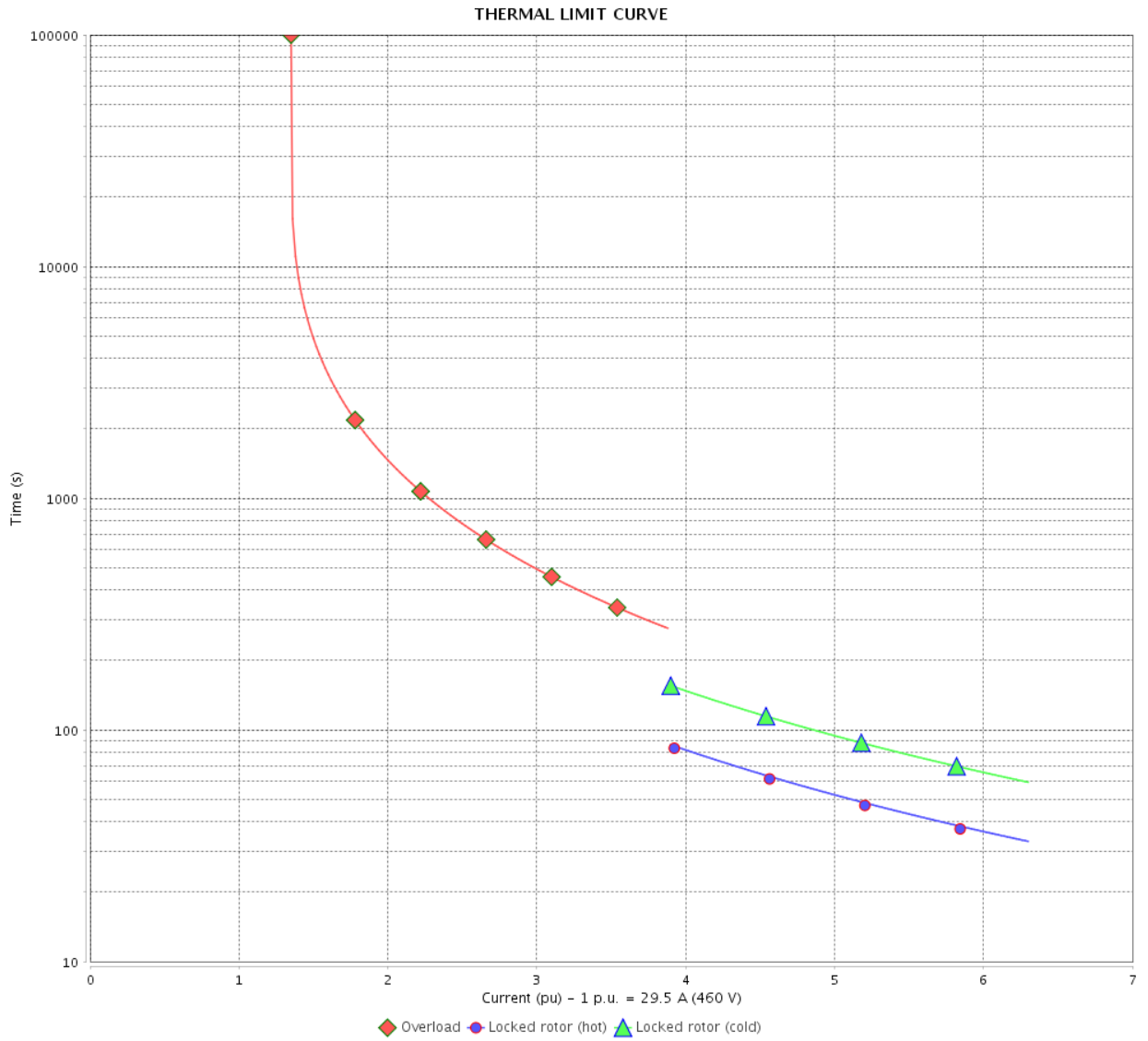

Rev.	Changes Summary	Performed	Checked	Date
Performed by		Page		Revision
Checked by		11 / 21		
Date		13/04/2022		

THERMAL LIMIT CURVE



Three Phase Induction Motor - Squirrel Cage

Customer :

Product line : W40 NEMA Premium Efficiency
Three-Phase

Product code : 14503702

Catalog # : 02518OT3E284T-W40G

Performance : 380 V 50 Hz 4P IE3

Rated current	: 29.5 A	Moment of inertia (J)	: 3.71 sq.ft.lb
LRC	: 5.8	Duty cycle	: Cont.(S1)
Rated torque	: 71.4 ft.lb	Insulation class	: F
Locked rotor torque	: 229 %	Service factor	: 1.00
Breakdown torque	: 250 %	Temperature rise	: 80 K
Rated speed	: 1465 rpm	Design	: B

Heating constant

Cooling constant

Rev.	Changes Summary	Performed	Checked	Date
Performed by				
Checked by			Page	Revision
Date	13/04/2022		12 / 21	

THERMAL LIMIT CURVE

Three Phase Induction Motor - Squirrel Cage



Customer : _____

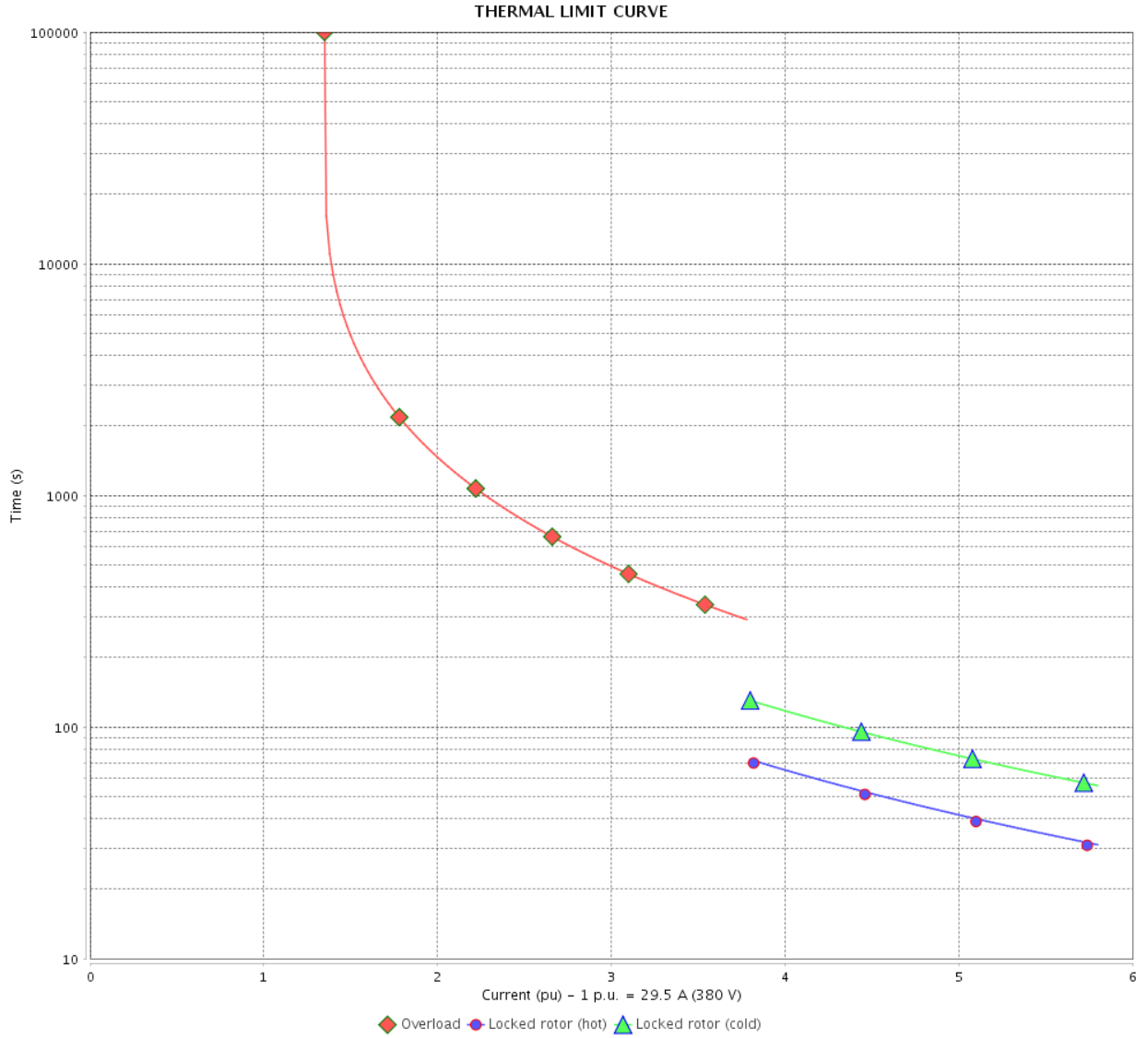

Rev.	Changes Summary	Performed	Checked	Date
Performed by				
Checked by				
Date				
		Page	Revision	
		13 / 21		

THERMAL LIMIT CURVE



Three Phase Induction Motor - Squirrel Cage

Customer :

Product line : W40 NEMA Premium Efficiency
Three-Phase

Product code : 14503702

Catalog # : 02518OT3E284T-W40G

Performance : 400 V 50 Hz 4P IE3

Rated current	: 28.7 A	Moment of inertia (J)	: 3.71 sq.ft.lb
LRC	: 6.7	Duty cycle	: Cont.(S1)
Rated torque	: 71.2 ft.lb	Insulation class	: F
Locked rotor torque	: 250 %	Service factor	: 1.00
Breakdown torque	: 290 %	Temperature rise	: 80 K
Rated speed	: 1470 rpm	Design	: B

Heating constant

Cooling constant

Rev.	Changes Summary	Performed	Checked	Date
Performed by				
Checked by			Page	Revision
Date	13/04/2022		14 / 21	

THERMAL LIMIT CURVE

Three Phase Induction Motor - Squirrel Cage



Customer : _____

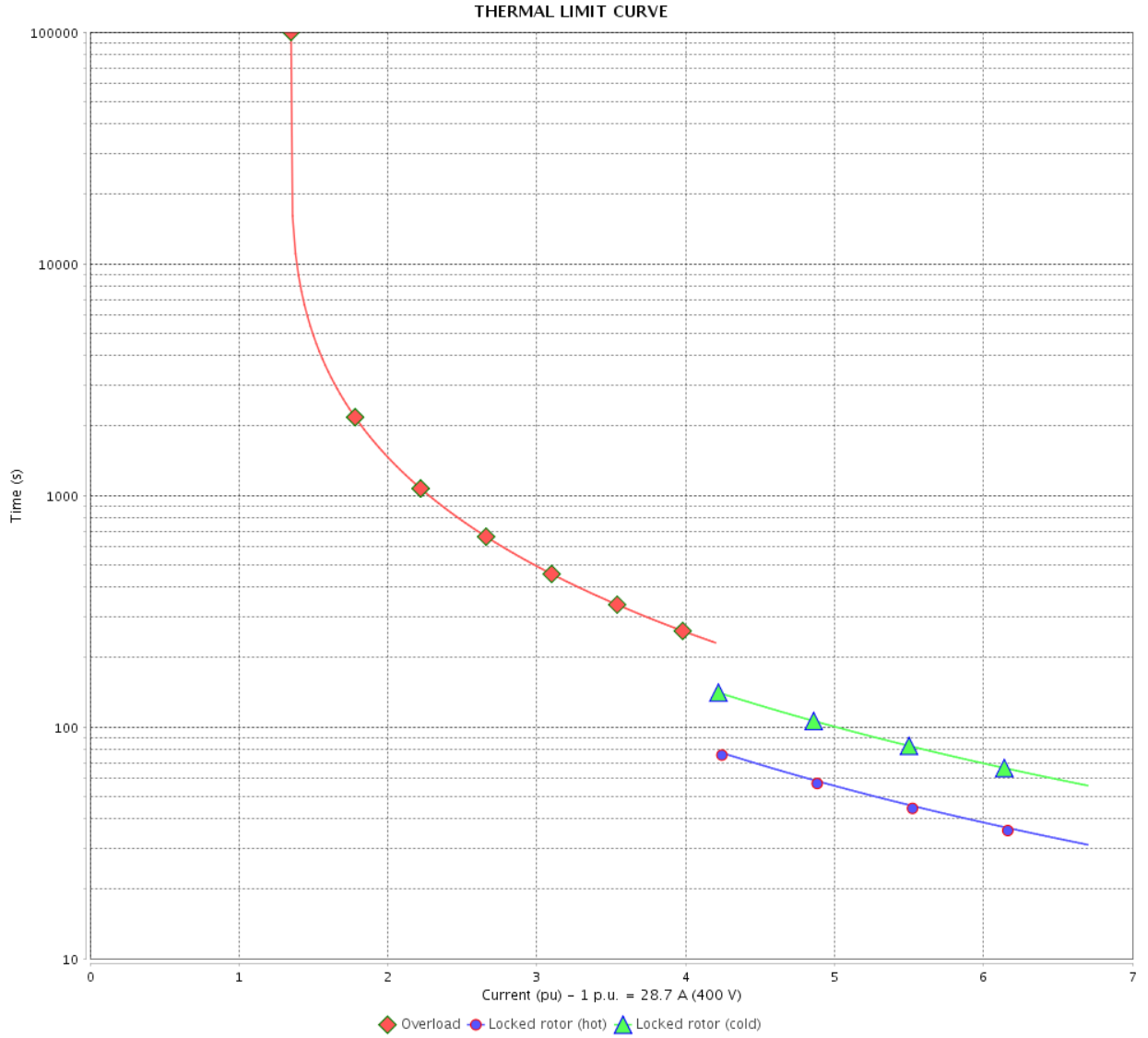

Rev.	Changes Summary	Performed	Checked	Date
Performed by				
Checked by				
Date				
		Page 15 / 21	Revision	

THERMAL LIMIT CURVE



Three Phase Induction Motor - Squirrel Cage

Customer :

Product line : W40 NEMA Premium Efficiency
Three-Phase

Product code : 14503702

Catalog # : 02518OT3E284T-W40G

Performance : 415 V 50 Hz 4P IE3

Rated current	: 28.0 A	Moment of inertia (J)	: 3.71 sq.ft.lb
LRC	: 6.8	Duty cycle	: Cont.(S1)
Rated torque	: 71.2 ft.lb	Insulation class	: F
Locked rotor torque	: 270 %	Service factor	: 1.00
Breakdown torque	: 300 %	Temperature rise	: 80 K
Rated speed	: 1475 rpm	Design	: B

Heating constant

Cooling constant

Rev.	Changes Summary	Performed	Checked	Date
Performed by				
Checked by			Page	Revision
Date	13/04/2022		16 / 21	

THERMAL LIMIT CURVE

Three Phase Induction Motor - Squirrel Cage



Customer : _____

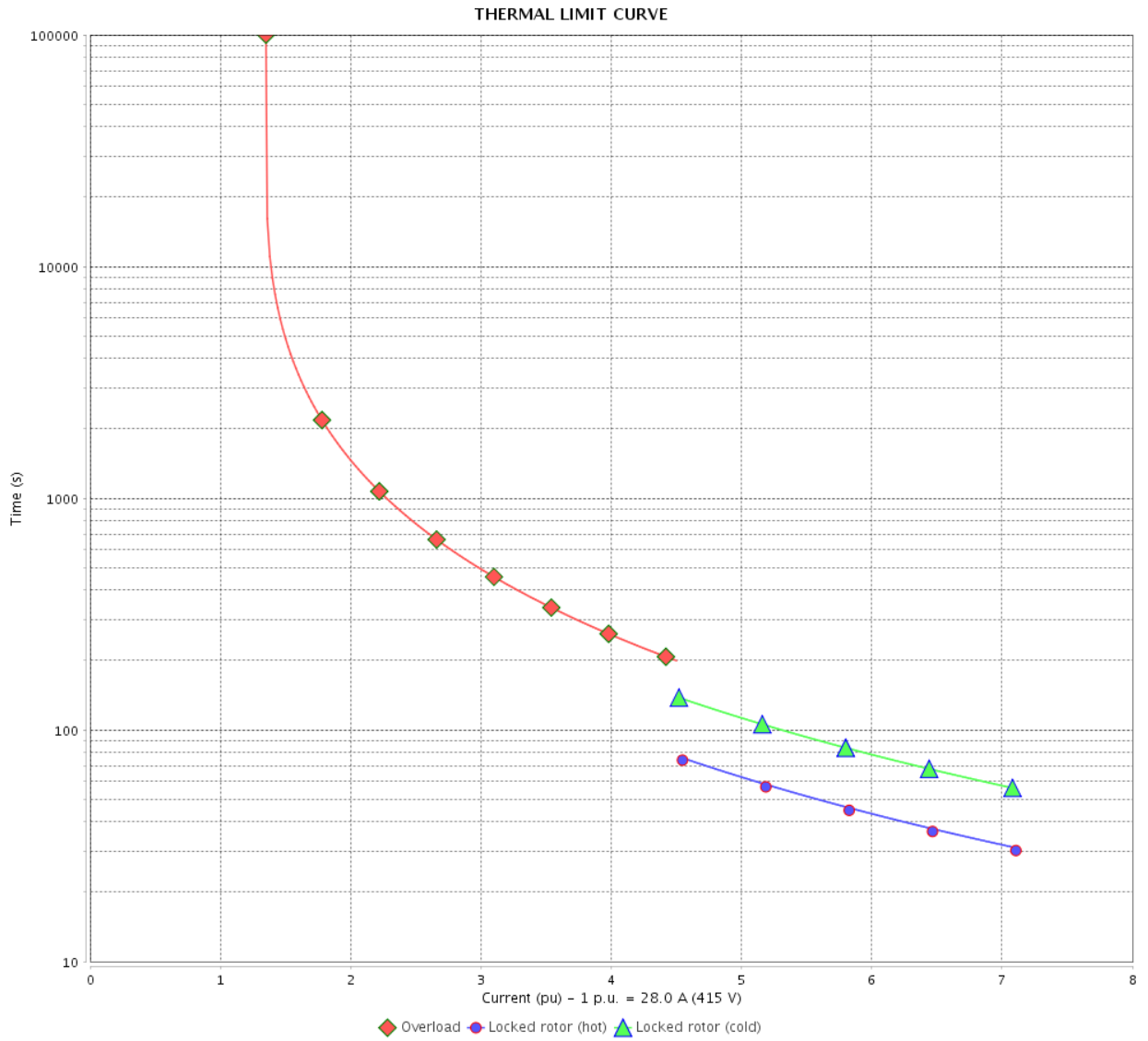

Rev.	Changes Summary	Performed	Checked	Date
Performed by		Page 17 / 21		Revision
Checked by				
Date				

VFD OPERATION CURVE

Three Phase Induction Motor - Squirrel Cage



Customer :

Product line : W40 NEMA Premium Efficiency Three-Phase

Product code : 14503702

Catalog # : 02518OT3E284T-W40G

VFD OPERATION CURVE

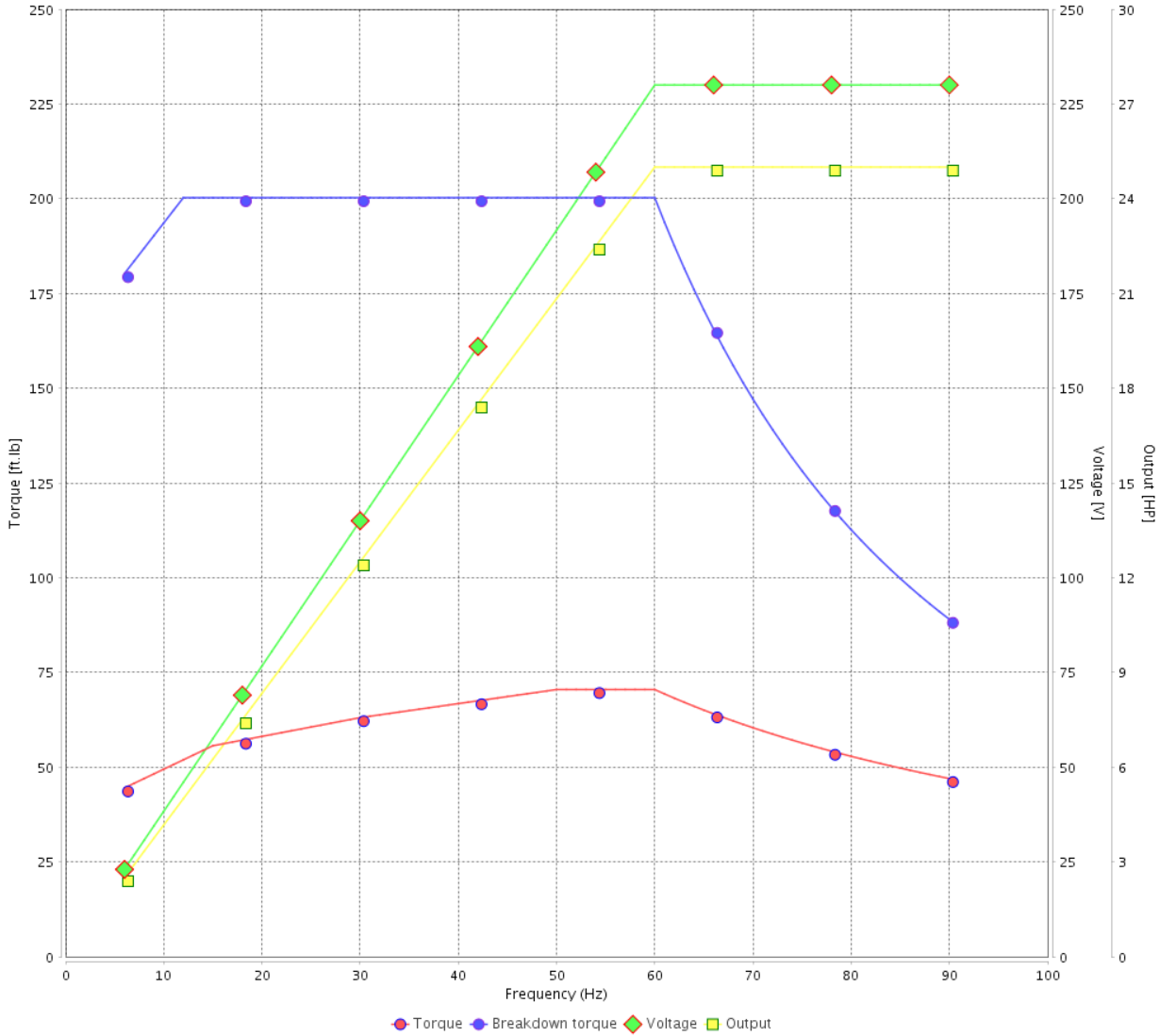

Performance : 230/460 V 60 Hz 4P

Rated current : 59.0/29.5 A
 LRC : 6.3
 Rated torque : 74.2 ft.lb
 Locked rotor torque : 250 %
 Breakdown torque : 270 %
 Rated speed : 1765 rpm

Moment of inertia (J) : 3.71 sq.ft.lb
 Duty cycle : Cont.(S1)
 Insulation class : F
 Service factor : 1.25
 Temperature rise : 80 K
 Design : B

Rev.	Changes Summary	Performed	Checked	Date
Performed by			Page 18 / 21	Revision
Checked by				
Date	13/04/2022			

VFD OPERATION CURVE

Three Phase Induction Motor - Squirrel Cage



Customer :

Product line : W40 NEMA Premium Efficiency
Three-Phase

Product code : 14503702

Catalog # : 02518OT3E284T-W40G

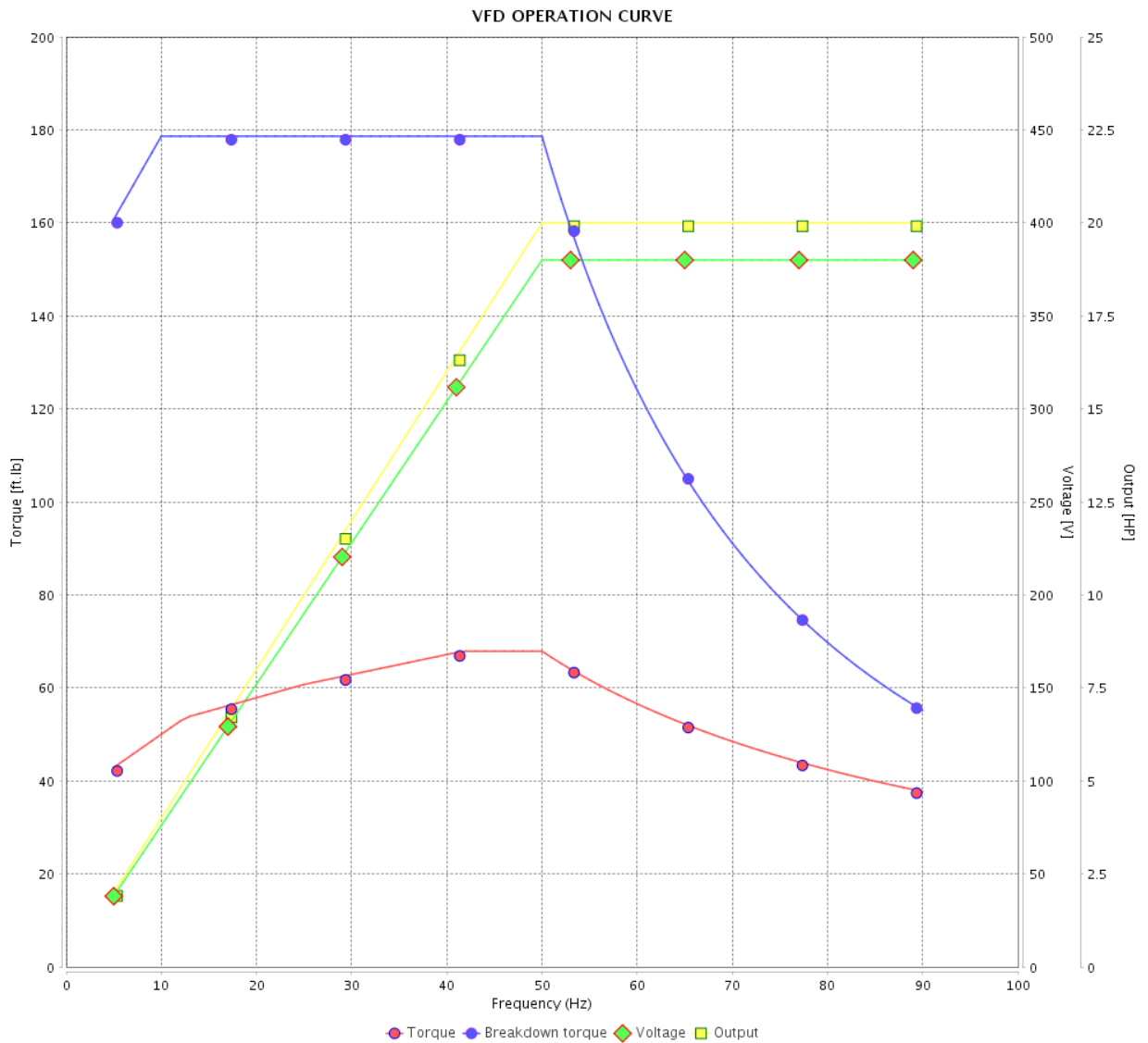

Performance : 380 V 50 Hz 4P IE3

Rated current : 29.5 A
 LRC : 5.8
 Rated torque : 71.4 ft.lb
 Locked rotor torque : 229 %
 Breakdown torque : 250 %
 Rated speed : 1465 rpm

Moment of inertia (J) : 3.71 sq.ft.lb
 Duty cycle : Cont.(S1)
 Insulation class : F
 Service factor : 1.00
 Temperature rise : 80 K
 Design : B

Rev.	Changes Summary	Performed	Checked	Date
Performed by			Page 19 / 21	Revision
Checked by				
Date	13/04/2022			

VFD OPERATION CURVE

Three Phase Induction Motor - Squirrel Cage



Customer :

Product line : W40 NEMA Premium Efficiency Three-Phase

Product code : 14503702

Catalog # : 02518OT3E284T-W40G

VFD OPERATION CURVE

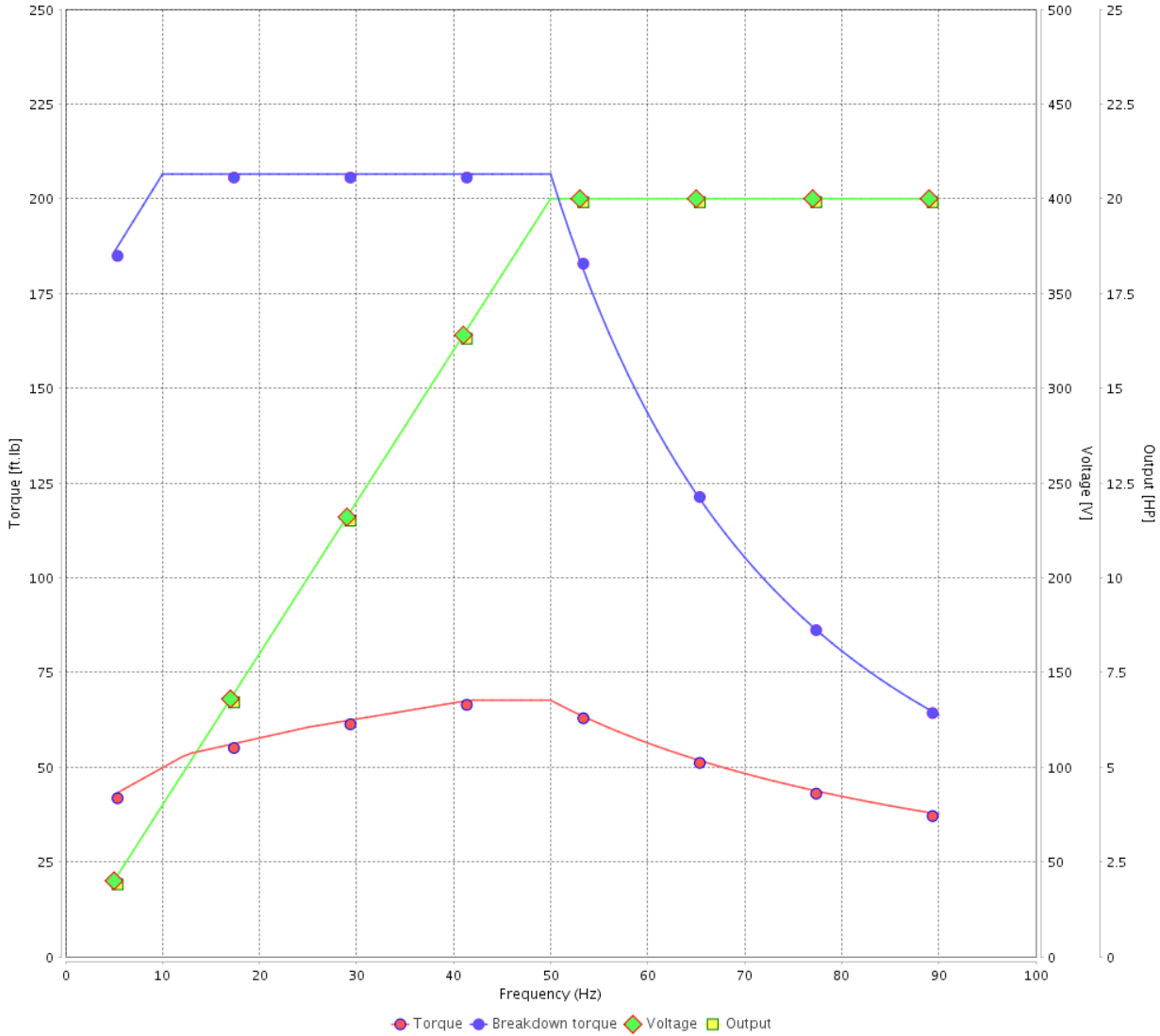

Performance : 400 V 50 Hz 4P IE3

Rated current : 28.7 A
 LRC : 6.7
 Rated torque : 71.2 ft.lb
 Locked rotor torque : 250 %
 Breakdown torque : 290 %
 Rated speed : 1470 rpm

Moment of inertia (J) : 3.71 sq.ft.lb
 Duty cycle : Cont.(S1)
 Insulation class : F
 Service factor : 1.00
 Temperature rise : 80 K
 Design : B

Rev.	Changes Summary	Performed	Checked	Date
Performed by			Page 20 / 21	Revision
Checked by				
Date	13/04/2022			

VFD OPERATION CURVE

Three Phase Induction Motor - Squirrel Cage



Customer :

Product line : W40 NEMA Premium Efficiency
Three-Phase

Product code : 14503702

Catalog # : 02518OT3E284T-W40G

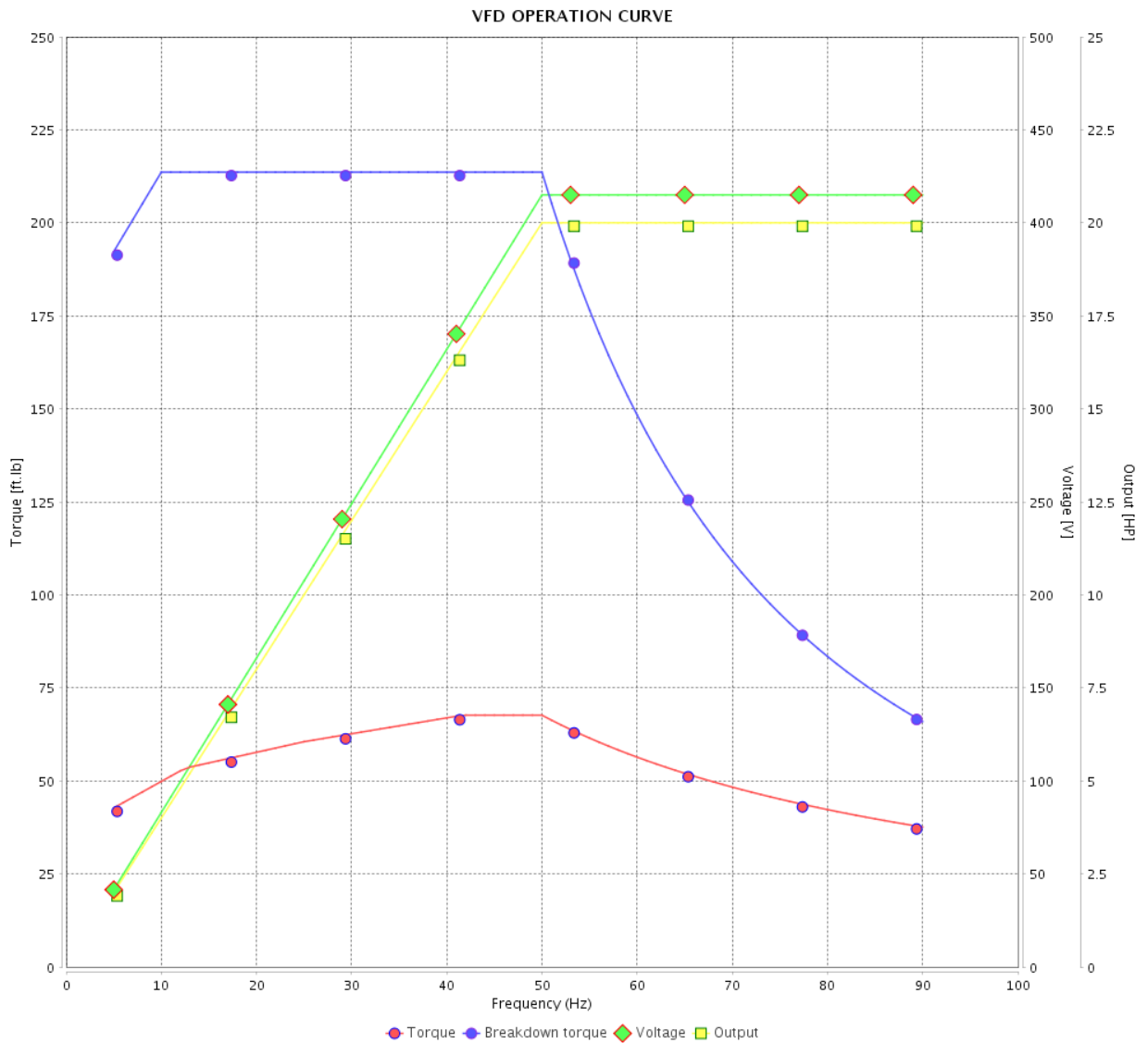

Performance : 415 V 50 Hz 4P IE3

Rated current : 28.0 A
LRC : 6.8
Rated torque : 71.2 ft.lb
Locked rotor torque : 270 %
Breakdown torque : 300 %
Rated speed : 1475 rpm

Moment of inertia (J) : 3.71 sq.ft.lb
Duty cycle : Cont.(S1)
Insulation class : F
Service factor : 1.00
Temperature rise : 80 K
Design : B

Rev.	Changes Summary	Performed	Checked	Date
Performed by			Page 21 / 21	Revision
Checked by				
Date	13/04/2022			

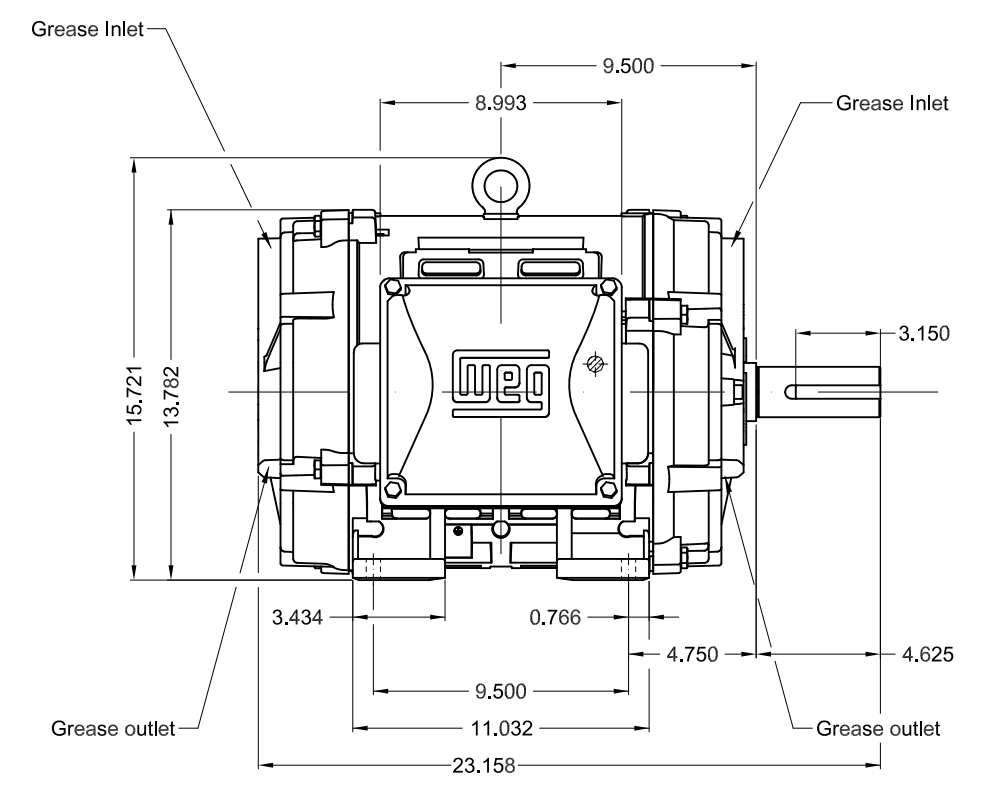
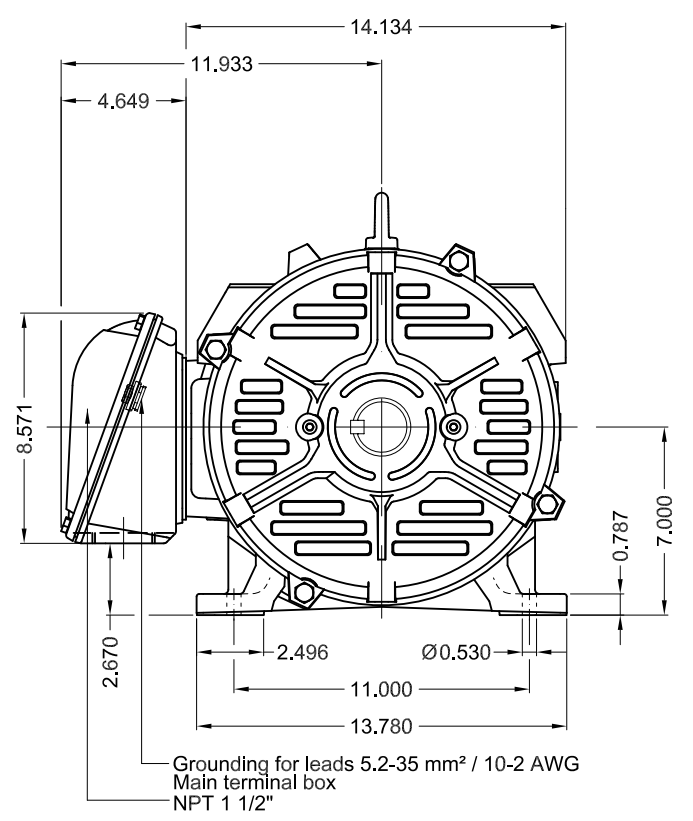

25 HP 04 Poles 60 Hz A

1:7

ECM	LOC	SUMMARY OF MODIFICATIONS	EXECUTED	CHECKED	RELEASED	DATE	VER
EXECUTED	PIRWBUSER	THREE PH. MOTOR W40 PREM. EFF.					
CHECKED		FRAME 284T IP23 ODP					
RELEASED							
REL DT.	WMO	Jaragua do Sul	Product Engineering	SHEET	1 / 1		

- Bearing cap
- Internal AEGIS ground ring on the DE
- Color RAL 5009
- Painting plan 203A
- Mounting NEMA F-1
- Mounting B3R(D)

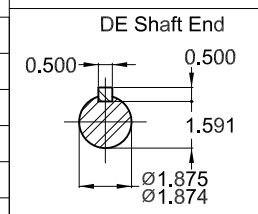

Dimensions in inches XME A3



WEG **W40 NEMA**
CC029A Premium
Inverter Duty Motor



IEC 60034-1
 MOD.T01#FOXON



For 60Hz use on PWM, VT 1000:1, CT 3:1, 1.0SF

MODEL 025180T3E284T-W40G
 MADE IN BRAZIL
 14503702

PH 3	FR 284T	HP(kW) 25.0(18.5)		Hz 60	
V 230/460		A 59.0/29.5		RPM 1770	DES B
NEMA NOM EFF 93.6 %		INS. CL. F ΔT 80 K		IP23	
ENCL ODP		DUTY CONT.		AMB. 40°C	
CODE G	PF 0.84	SF 1.25	SFA 73.8/36.9		
USABLE @208V 65.2 A		SF 1.15	SFA 75.0		
20HP 15kW 50Hz 380V 29.5A 1470RPM SF1.00 EFF 92.1% (IE3)				ALT 1000	m.a.s.l.

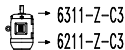
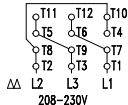

MOBIL POLYREX EM
 18 g 20000 h

ALT 1000 m.a.s.l. 348 Lbs