

DATA SHEET

Three Phase Induction Motor - Squirrel Cage



Customer :							
Product line	: NEMA Premium Efficiency Three-Phase	Product code :	12447101				
		Catalog # :	02536ET3E284TSC-W22				
Frame	: 284/6TSC	Cooling method	: IC411 - TEFC				
Insulation class	: F	Mounting	: F-1				
Duty cycle	: Cont.(S1)	Rotation ¹	: Both (CW and CCW)				
Ambient temperature	: -20°C to +40°C	Starting method	: Direct On Line				
Altitude	: 1000 m.a.s.l.	Approx. weight ²	: 406 lb				
Protection degree	: IP55	Moment of inertia (J)	: 2.69 sq.ft.lb				
Design	: B						
Output [HP]	25	20	20	20	25	25	25
Poles	2	2	2	2	2	2	2
Frequency [Hz]	60	50	50	50	50	50	50
Rated voltage [V]	230/460	380	400	415	380	400	415
Rated current [A]	57.0/28.5	27.6	26.5	25.8	34.9	33.3	31.8
L. R. Amperes [A]	359/180	171	183	191	171	183	191
LRC [A]	6.3x(Code G)	6.2x(Code G)	6.9x(Code H)	7.4x(Code H)	4.9x(Code E)	5.5x(Code F)	6.0x(Code F)
No load current [A]	15.0/7.50	7.40	7.90	8.30	7.40	7.90	8.30
Rated speed [RPM]	3535	2930	2940	2945	2910	2920	2935
Slip [%]	1.81	2.33	2.00	1.83	3.00	2.67	2.17
Rated torque [ft.lb]	37.1	35.8	35.7	35.7	45.1	45.0	44.7
Locked rotor torque [%]	200	200	229	240	160	180	190
Breakdown torque [%]	250	240	280	300	190	220	240
Service factor	1.25	1.00	1.00	1.00	1.00	1.00	1.00
Temperature rise	80 K	80 K	80 K	80 K	105 K	105 K	105 K
Locked rotor time	30s (cold) 17s (hot)	25s (cold) 14s (hot)	25s (cold) 14s (hot)	25s (cold) 14s (hot)	25s (cold) 14s (hot)	25s (cold) 14s (hot)	25s (cold) 14s (hot)
Noise level ²	72.0 dB(A)	67.0 dB(A)	67.0 dB(A)	67.0 dB(A)	67.0 dB(A)	67.0 dB(A)	67.0 dB(A)
Efficiency (%)	25%						
	50%	91.0	90.2	90.3	89.8	91.0	91.0
	75%	91.7	90.7	91.1	91.1	90.2	91.0
	100%	91.7	91.9	91.9	91.9	89.5	90.2
Power Factor	25%						
	50%	0.82	0.79	0.78	0.75	0.85	0.84
	75%	0.87	0.87	0.86	0.85	0.89	0.88
	100%	0.89	0.90	0.89	0.88	0.90	0.89
Bearing type	: Drive end : 6311 C3	Non drive end : 6211 C3	Foundation loads				
Sealing	: V'Ring	V'Ring	Max. traction	: 265 lb			
Lubrication interval	: 14000 h	17000 h	Max. compression	: 671 lb			
Lubricant amount	: 18 g	11 g					
Lubricant type	: Mobil Polyrex EM						
Notes USABLE @208V 63.0A SF 1.10 SFA 69.3A							
This revision replaces and cancel the previous one, which must be eliminated. (1) Looking the motor from the shaft end. (2) Measured at 1m and with tolerance of +3dB(A). (3) Approximate weight subject to changes after manufacturing process. (4) At 100% of full load.				These are average values based on tests with sinusoidal power supply, subject to the tolerances stipulated in NEMA MG-1.			
Rev.	Changes Summary			Performed	Checked	Date	
Performed by							
Checked by					Page	Revision	
Date	14/04/2022				1 / 36		

TORQUE AND CURRENT VS SPEED CURVE

Three Phase Induction Motor - Squirrel Cage



Customer :

Product line : NEMA Premium Efficiency Three-Phase

Product code : 12447101

Catalog # : 02536ET3E284TSC-W22

TORQUE AND CURRENT VS SPEED CURVE

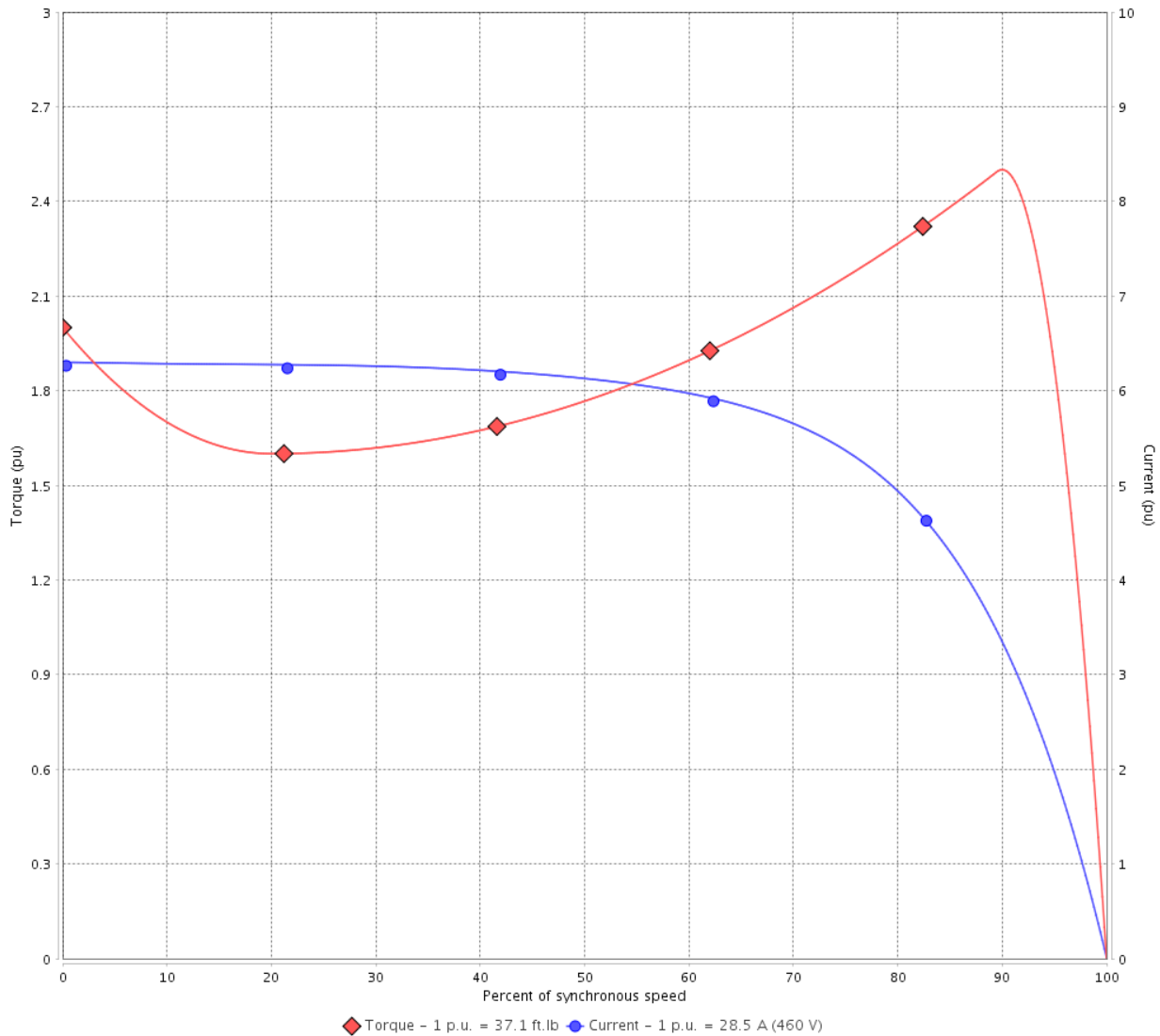

Performance : 230/460 V 60 Hz 2P

Rated current	: 57.0/28.5 A	Moment of inertia (J)	: 2.69 sq.ft.lb
LRC	: 6.3	Duty cycle	: Cont.(S1)
Rated torque	: 37.1 ft.lb	Insulation class	: F
Locked rotor torque	: 200 %	Service factor	: 1.25
Breakdown torque	: 250 %	Temperature rise	: 80 K
Rated speed	: 3535 rpm	Design	: B

Locked rotor time : 30s (cold) 17s (hot)

Rev.	Changes Summary	Performed	Checked	Date
Performed by			Page 2 / 36	Revision
Checked by				
Date	14/04/2022			

TORQUE AND CURRENT VS SPEED CURVE



Three Phase Induction Motor - Squirrel Cage

Customer :

Product line : NEMA Premium Efficiency Three-Phase

Product code : 12447101

Catalog # : 02536ET3E284TSC-W22

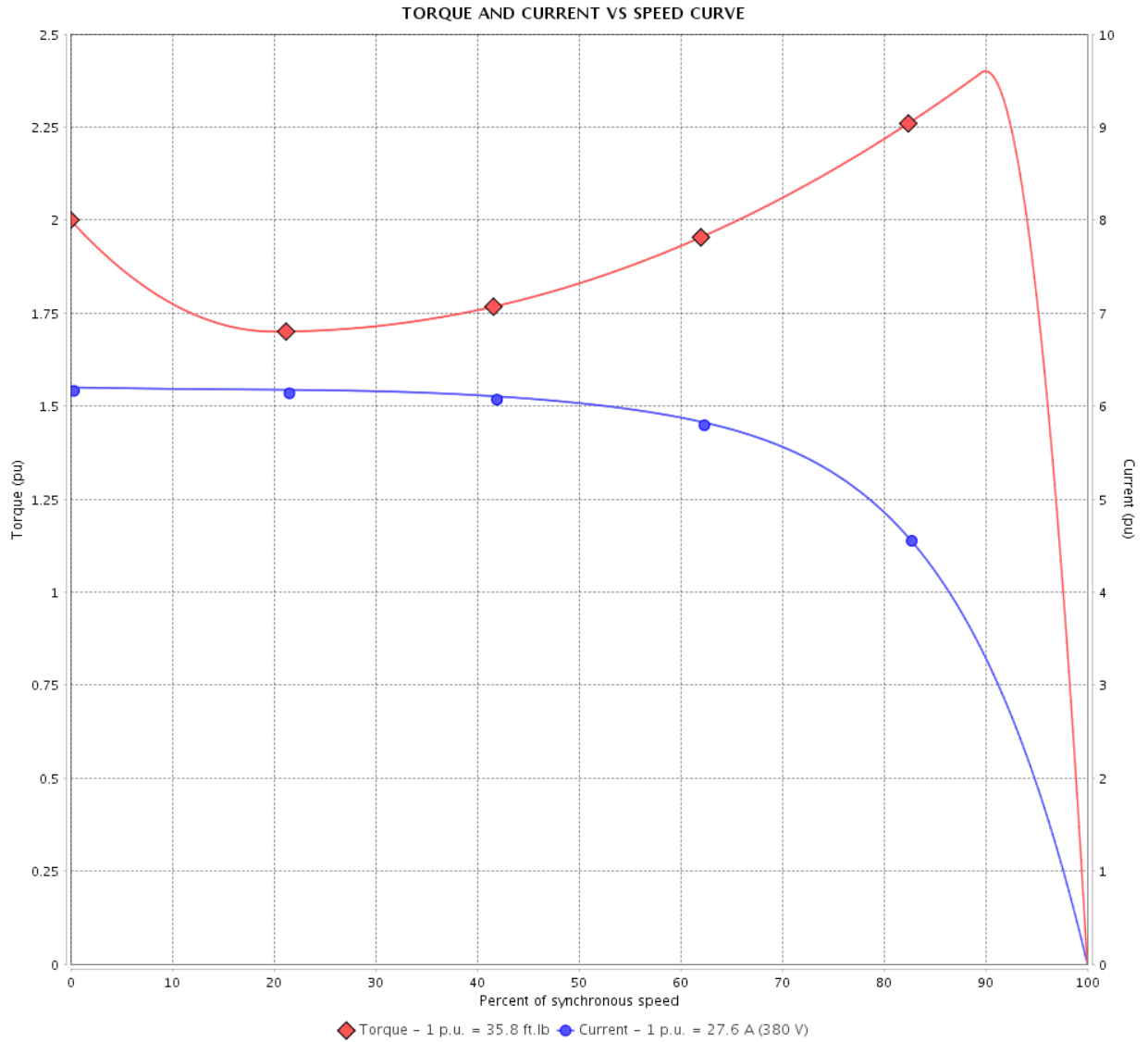

Performance : 380 V 50 Hz 2P IE3

Rated current : 27.6 A
 LRC : 6.2
 Rated torque : 35.8 ft.lb
 Locked rotor torque : 200 %
 Breakdown torque : 240 %
 Rated speed : 2930 rpm

Moment of inertia (J) : 2.69 sq.ft.lb
 Duty cycle : Cont.(S1)
 Insulation class : F
 Service factor : 1.00
 Temperature rise : 80 K
 Design : B

Locked rotor time : 25s (cold) 14s (hot)

Rev.	Changes Summary	Performed	Checked	Date
Performed by			Page 3 / 36	Revision
Checked by				
Date	14/04/2022			

TORQUE AND CURRENT VS SPEED CURVE

Three Phase Induction Motor - Squirrel Cage



Customer :

Product line : NEMA Premium Efficiency Three-Phase

Product code : 12447101

Catalog # : 02536ET3E284TSC-W22

TORQUE AND CURRENT VS SPEED CURVE

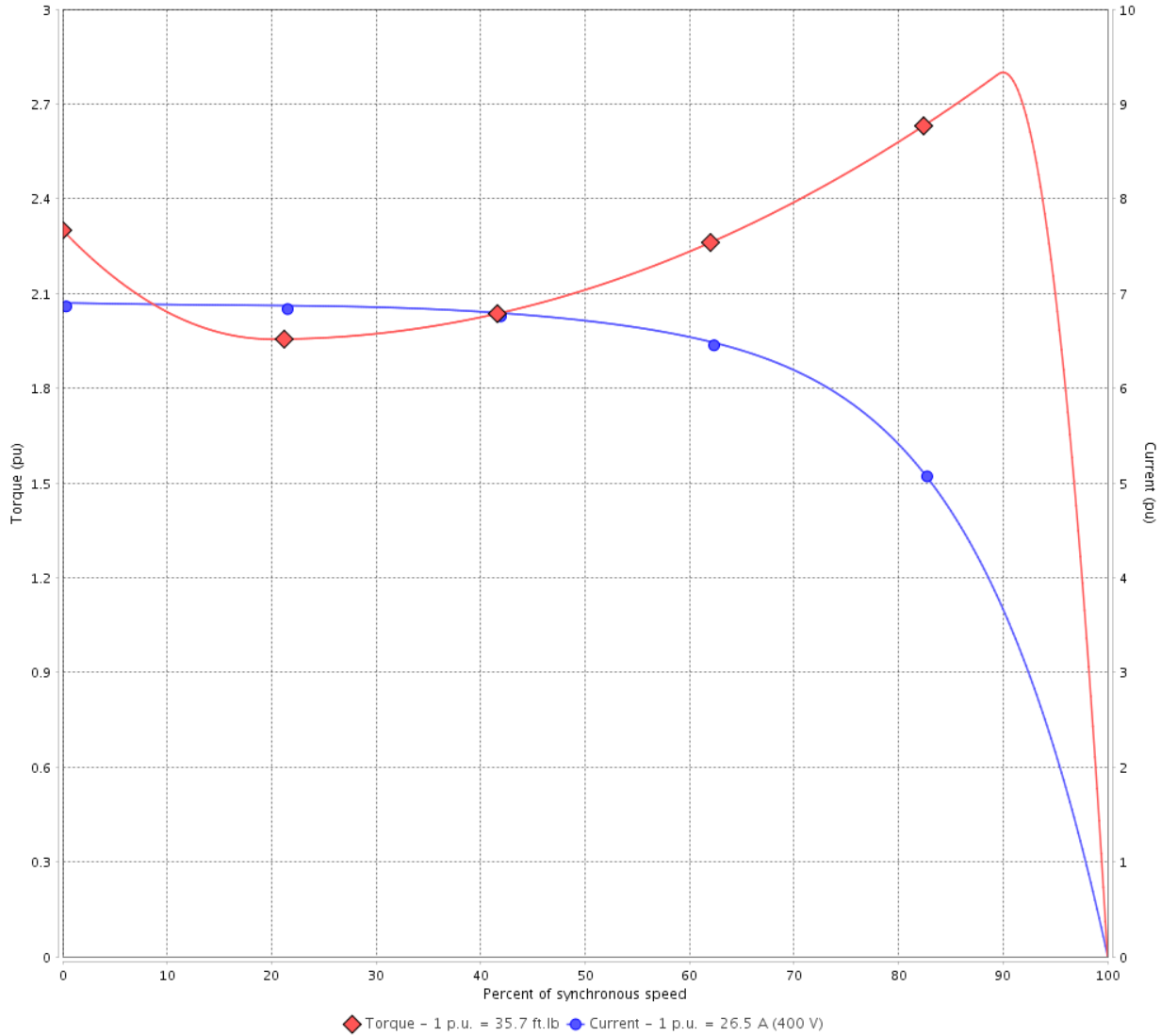

Performance : 400 V 50 Hz 2P IE3

Rated current	: 26.5 A	Moment of inertia (J)	: 2.69 sq.ft.lb
LRC	: 6.9	Duty cycle	: Cont.(S1)
Rated torque	: 35.7 ft.lb	Insulation class	: F
Locked rotor torque	: 229 %	Service factor	: 1.00
Breakdown torque	: 280 %	Temperature rise	: 80 K
Rated speed	: 2940 rpm	Design	: B

Locked rotor time : 25s (cold) 14s (hot)

Rev.	Changes Summary	Performed	Checked	Date
Performed by			Page 4 / 36	Revision
Checked by				
Date	14/04/2022			

TORQUE AND CURRENT VS SPEED CURVE



Three Phase Induction Motor - Squirrel Cage

Customer :

Product line : NEMA Premium Efficiency Three-Phase

Product code : 12447101

Catalog # : 02536ET3E284TSC-W22

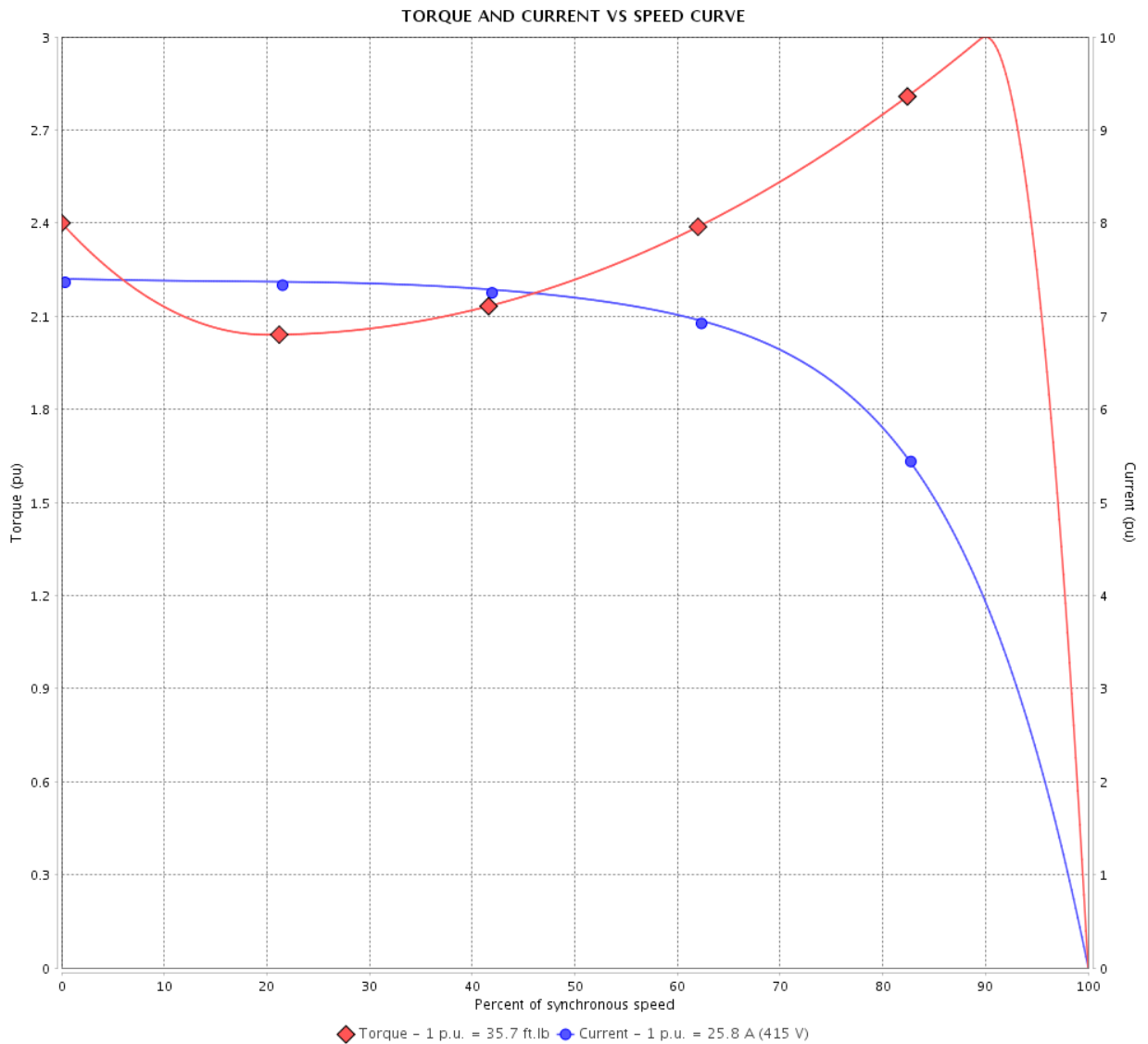

Performance : 415 V 50 Hz 2P IE3

Rated current	: 25.8 A	Moment of inertia (J)	: 2.69 sq.ft.lb
LRC	: 7.4	Duty cycle	: Cont.(S1)
Rated torque	: 35.7 ft.lb	Insulation class	: F
Locked rotor torque	: 240 %	Service factor	: 1.00
Breakdown torque	: 300 %	Temperature rise	: 80 K
Rated speed	: 2945 rpm	Design	: B

Locked rotor time : 25s (cold) 14s (hot)

Rev.	Changes Summary	Performed	Checked	Date
Performed by		Page		Revision
Checked by		5 / 36		
Date	14/04/2022			

TORQUE AND CURRENT VS SPEED CURVE

Three Phase Induction Motor - Squirrel Cage



Customer :

Product line : NEMA Premium Efficiency Three-Phase

Product code : 12447101

Catalog # : 02536ET3E284TSC-W22

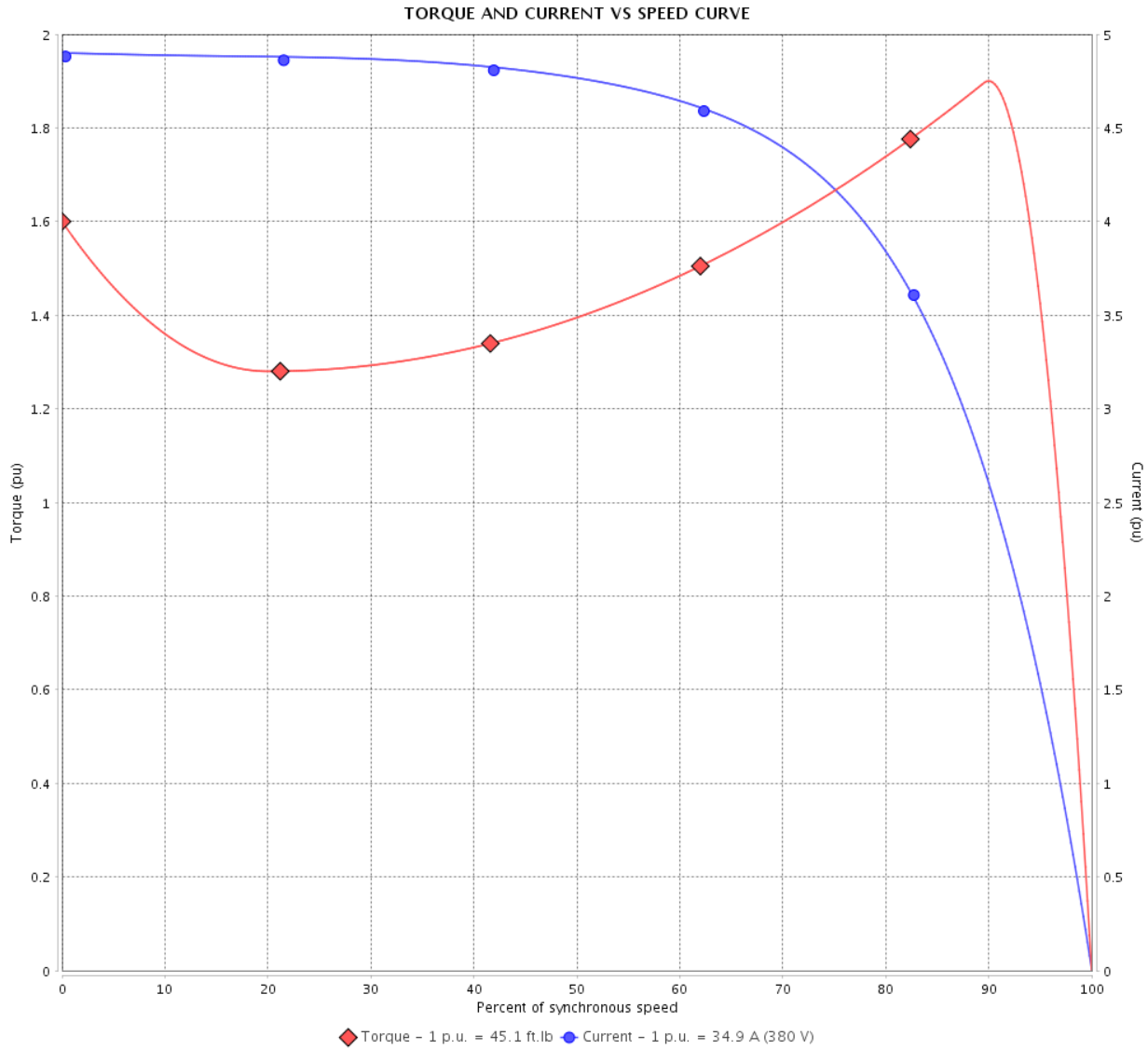

Performance : 380 V 50 Hz 2P IE1

Rated current	: 34.9 A	Moment of inertia (J)	: 2.69 sq.ft.lb
LRC	: 4.9	Duty cycle	: Cont.(S1)
Rated torque	: 45.1 ft.lb	Insulation class	: F
Locked rotor torque	: 160 %	Service factor	: 1.00
Breakdown torque	: 190 %	Temperature rise	: 105 K
Rated speed	: 2910 rpm	Design	: B

Locked rotor time : 25s (cold) 14s (hot)

Rev.	Changes Summary	Performed	Checked	Date
Performed by			Page 6 / 36	Revision
Checked by				
Date	14/04/2022			

TORQUE AND CURRENT VS SPEED CURVE



Three Phase Induction Motor - Squirrel Cage

Customer :

Product line : NEMA Premium Efficiency Three-Phase

Product code : 12447101

Catalog # : 02536ET3E284TSC-W22

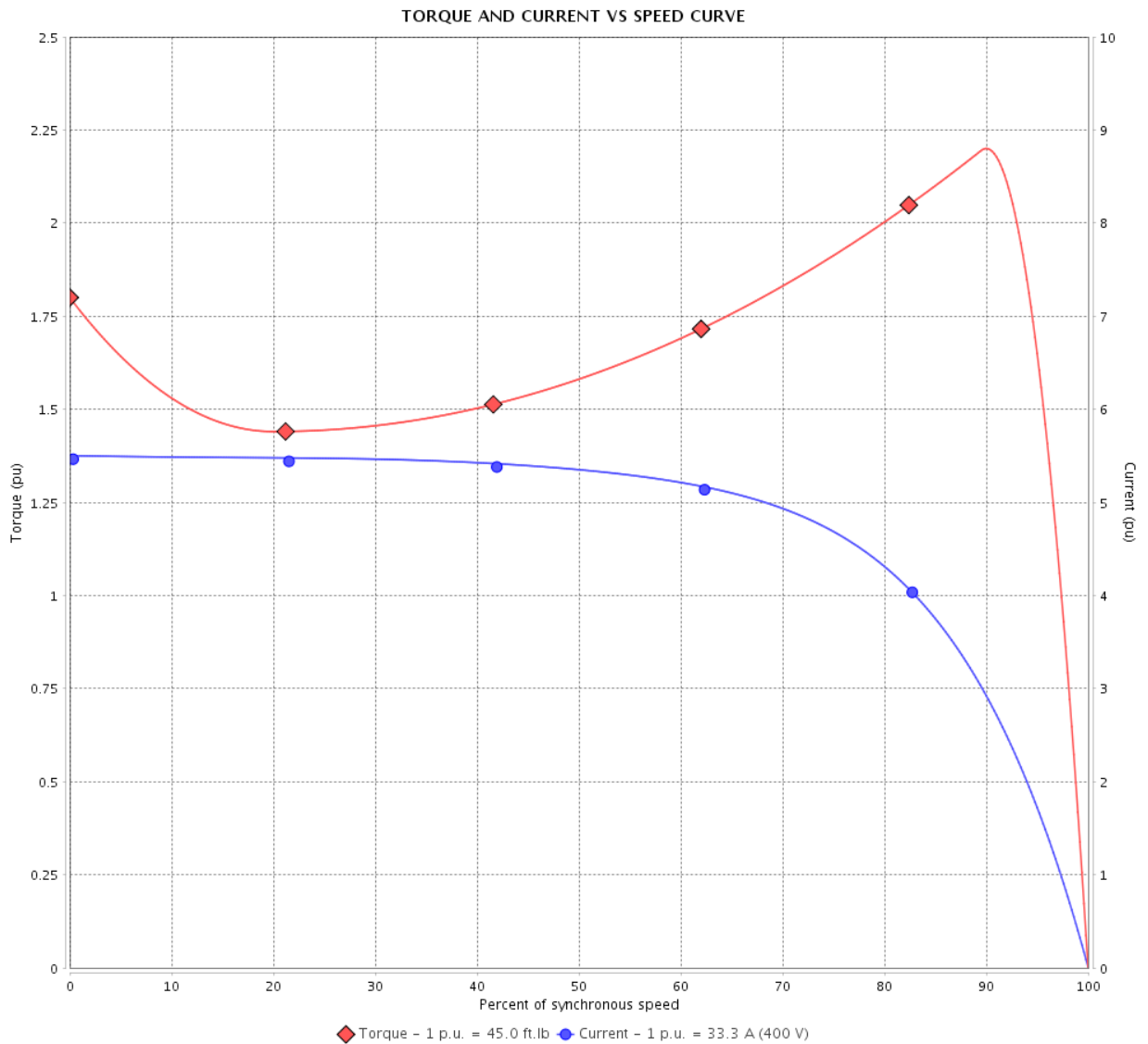

Performance : 400 V 50 Hz 2P IE1

Rated current	: 33.3 A	Moment of inertia (J)	: 2.69 sq.ft.lb
LRC	: 5.5	Duty cycle	: Cont.(S1)
Rated torque	: 45.0 ft.lb	Insulation class	: F
Locked rotor torque	: 180 %	Service factor	: 1.00
Breakdown torque	: 220 %	Temperature rise	: 105 K
Rated speed	: 2920 rpm	Design	: B

Locked rotor time : 25s (cold) 14s (hot)

Rev.	Changes Summary	Performed	Checked	Date
Performed by			Page 7 / 36	Revision
Checked by				
Date	14/04/2022			

TORQUE AND CURRENT VS SPEED CURVE

Three Phase Induction Motor - Squirrel Cage



Customer :

Product line : NEMA Premium Efficiency Three-Phase

Product code : 12447101

Catalog # : 02536ET3E284TSC-W22

TORQUE AND CURRENT VS SPEED CURVE

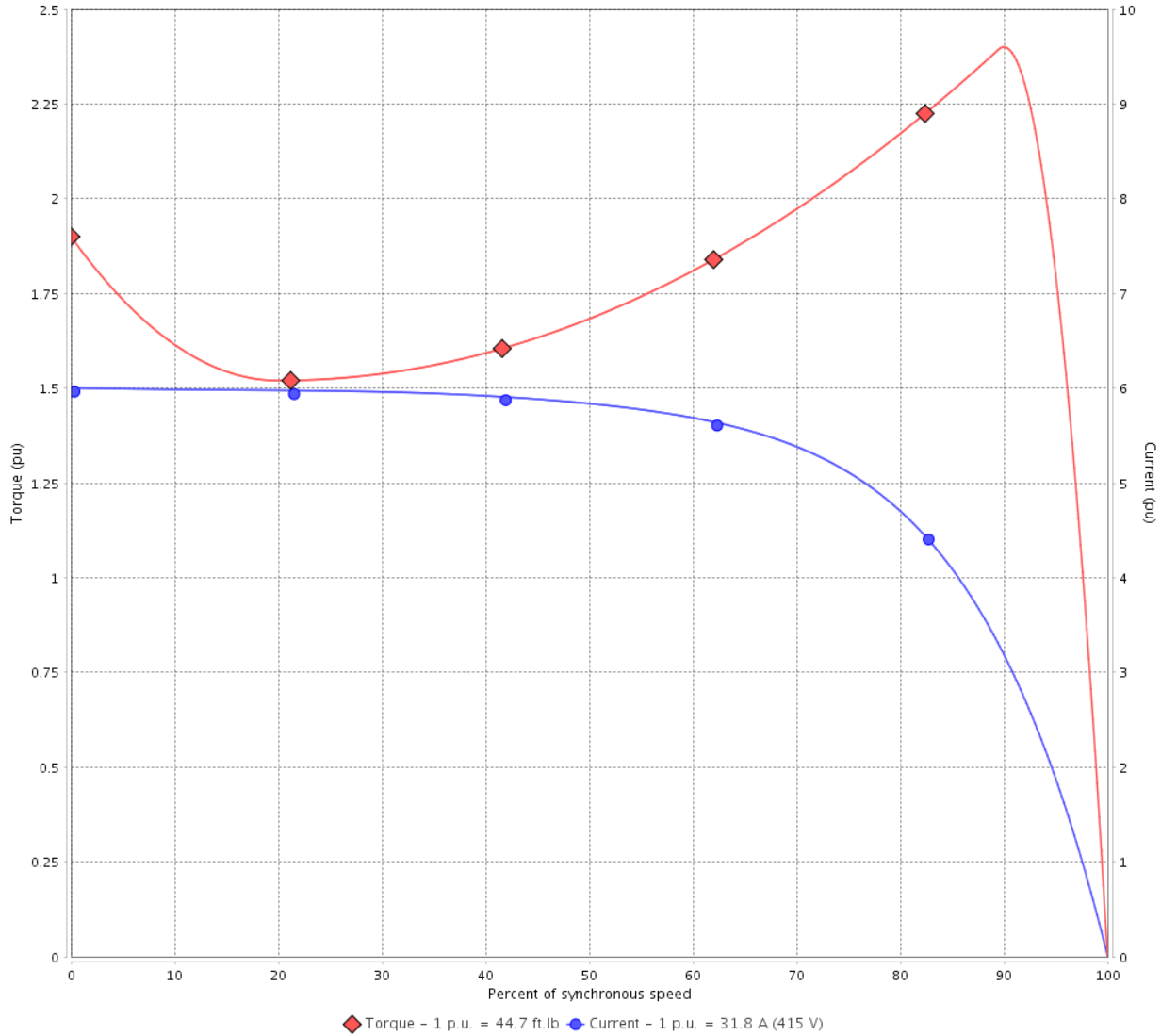

Performance : 415 V 50 Hz 2P IE2

Rated current	: 31.8 A	Moment of inertia (J)	: 2.69 sq.ft.lb
LRC	: 6.0	Duty cycle	: Cont.(S1)
Rated torque	: 44.7 ft.lb	Insulation class	: F
Locked rotor torque	: 190 %	Service factor	: 1.00
Breakdown torque	: 240 %	Temperature rise	: 105 K
Rated speed	: 2935 rpm	Design	: B

Locked rotor time : 25s (cold) 14s (hot)

Rev.	Changes Summary	Performed	Checked	Date
Performed by			Page 8 / 36	Revision
Checked by				
Date	14/04/2022			

LOAD PERFORMANCE CURVE

Three Phase Induction Motor - Squirrel Cage



Customer : _____

Product line : NEMA Premium Efficiency Three-Phase

Product code : 12447101

Catalog # : 02536ET3E284TSC-W22

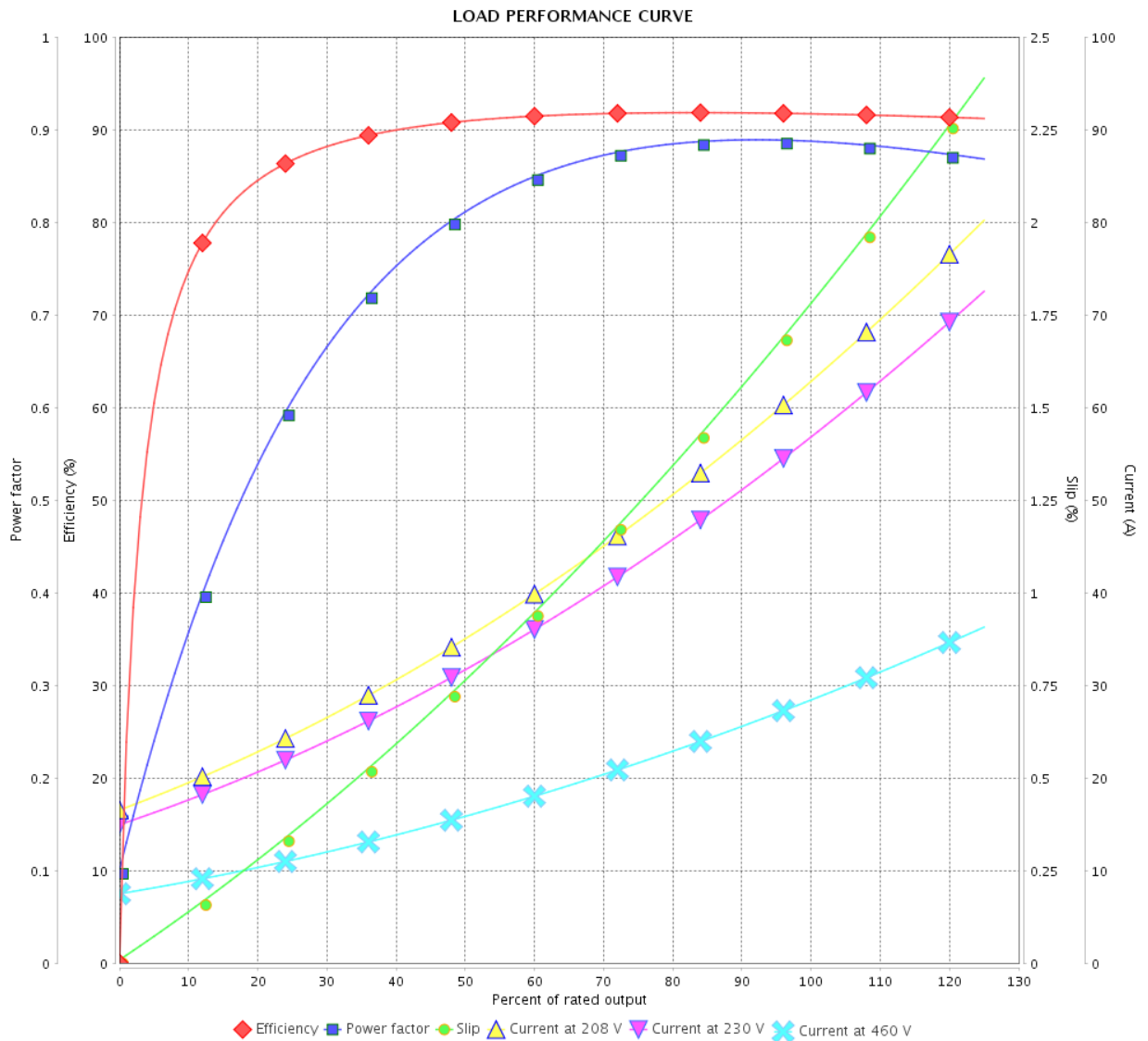

Performance : 230/460 V 60 Hz 2P

Rated current : 57.0/28.5 A
 LRC : 6.3
 Rated torque : 37.1 ft.lb
 Locked rotor torque : 200 %
 Breakdown torque : 250 %
 Rated speed : 3535 rpm

Moment of inertia (J) : 2.69 sq.ft.lb
 Duty cycle : Cont.(S1)
 Insulation class : F
 Service factor : 1.25
 Temperature rise : 80 K
 Design : B

Rev.	Changes Summary	Performed	Checked	Date
Performed by			Page	Revision
Checked by				
Date				

LOAD PERFORMANCE CURVE

Three Phase Induction Motor - Squirrel Cage



Customer :

Product line : NEMA Premium Efficiency Three-Phase

Product code : 12447101

Catalog # : 02536ET3E284TSC-W22

LOAD PERFORMANCE CURVE

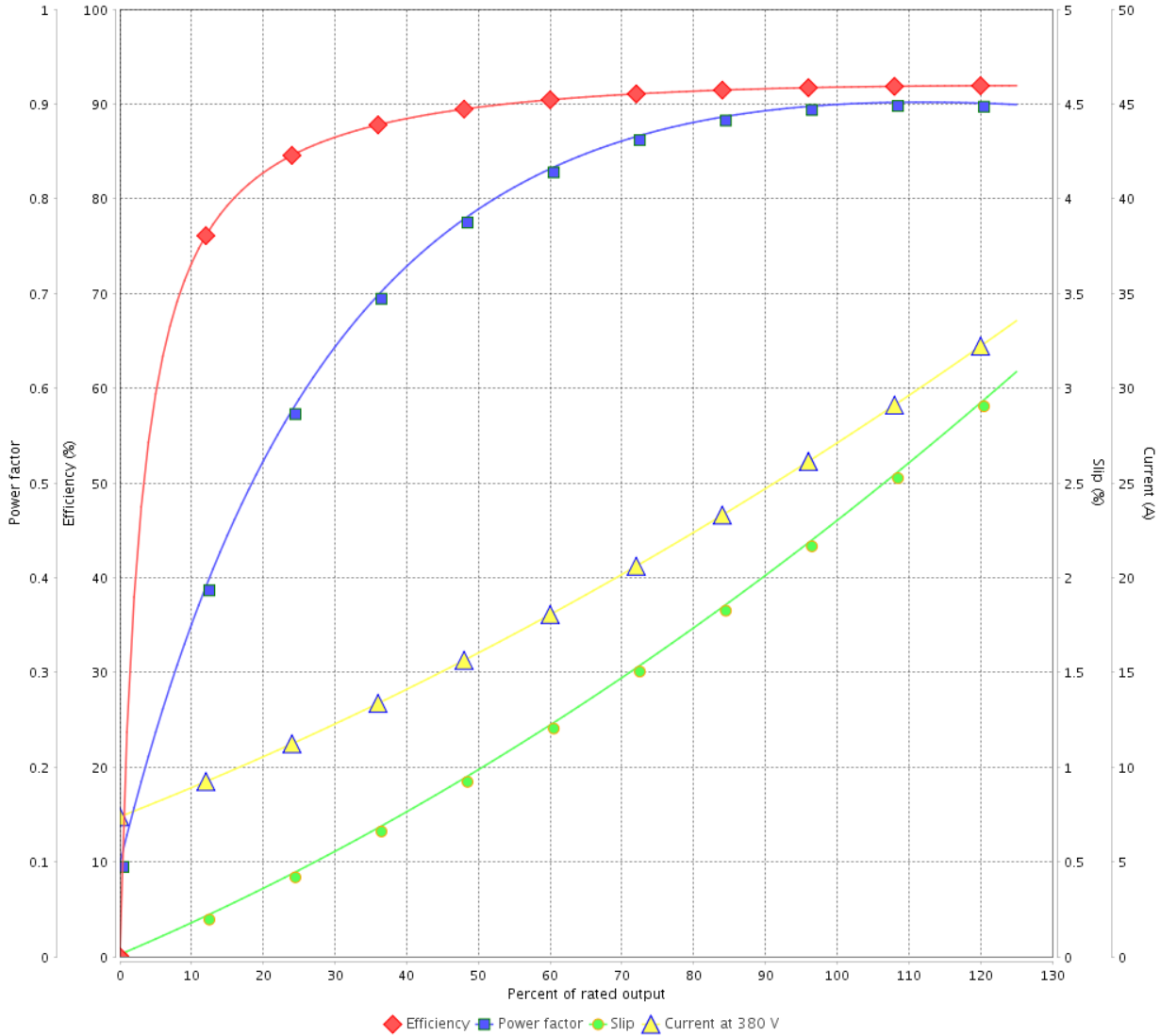

Performance : 380 V 50 Hz 2P IE3

Rated current : 27.6 A
 LRC : 6.2
 Rated torque : 35.8 ft.lb
 Locked rotor torque : 200 %
 Breakdown torque : 240 %
 Rated speed : 2930 rpm

Moment of inertia (J) : 2.69 sq.ft.lb
 Duty cycle : Cont.(S1)
 Insulation class : F
 Service factor : 1.00
 Temperature rise : 80 K
 Design : B

Rev.	Changes Summary	Performed	Checked	Date
Performed by			Page 10 / 36	Revision
Checked by				
Date	14/04/2022			

LOAD PERFORMANCE CURVE

Three Phase Induction Motor - Squirrel Cage



Customer : _____

Product line : NEMA Premium Efficiency Three-Phase

Product code : 12447101

Catalog # : 02536ET3E284TSC-W22

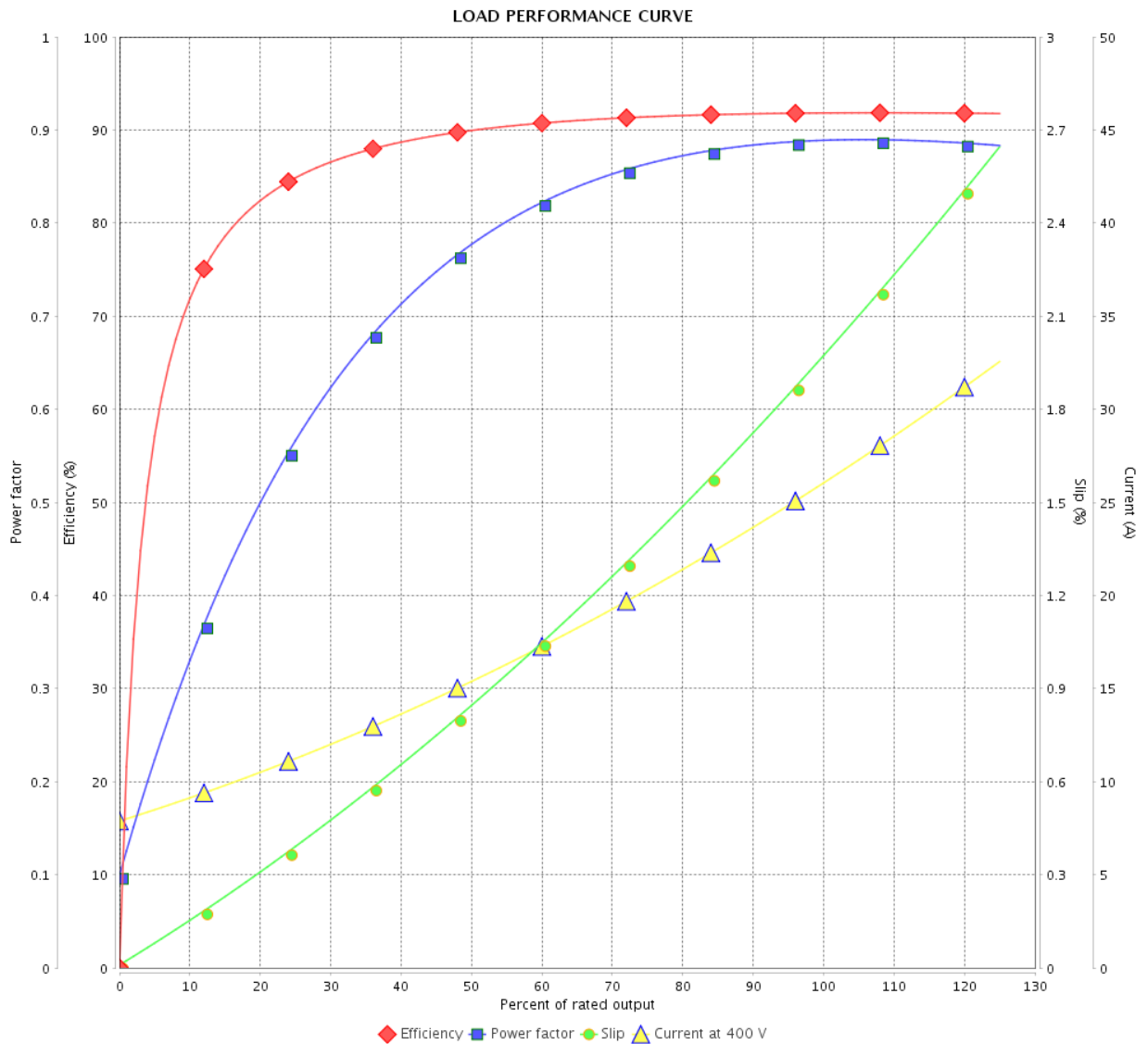

Performance : 400 V 50 Hz 2P IE3

Rated current : 26.5 A
 LRC : 6.9
 Rated torque : 35.7 ft.lb
 Locked rotor torque : 229 %
 Breakdown torque : 280 %
 Rated speed : 2940 rpm

Moment of inertia (J) : 2.69 sq.ft.lb
 Duty cycle : Cont.(S1)
 Insulation class : F
 Service factor : 1.00
 Temperature rise : 80 K
 Design : B

Rev.	Changes Summary	Performed	Checked	Date
Performed by		Page		Revision
Checked by		11 / 36		
Date		14/04/2022		

LOAD PERFORMANCE CURVE

Three Phase Induction Motor - Squirrel Cage



Customer :

Product line : NEMA Premium Efficiency Three-Phase

Product code : 12447101

Catalog # : 02536ET3E284TSC-W22

LOAD PERFORMANCE CURVE

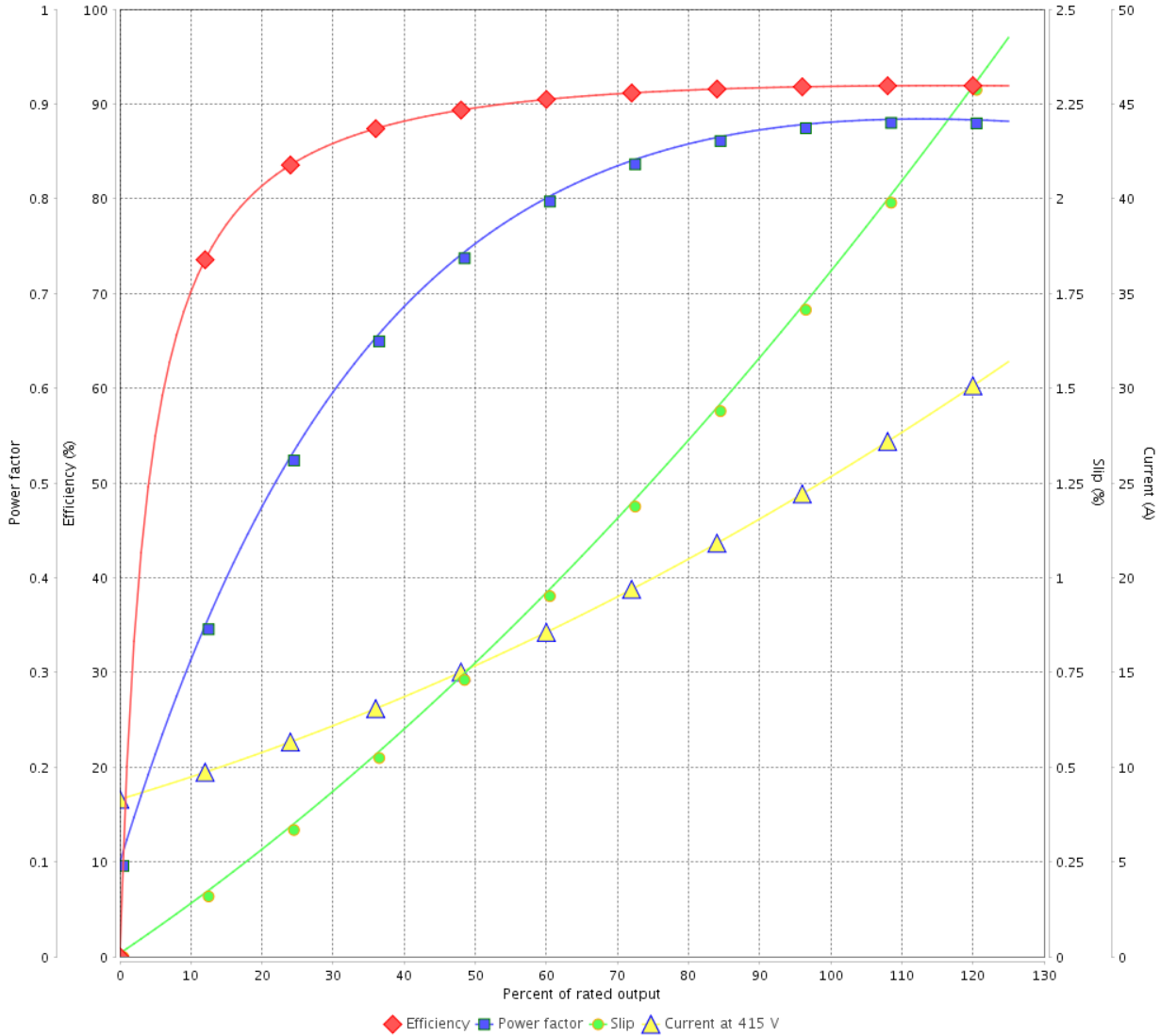

Performance : 415 V 50 Hz 2P IE3

Rated current : 25.8 A
 LRC : 7.4
 Rated torque : 35.7 ft.lb
 Locked rotor torque : 240 %
 Breakdown torque : 300 %
 Rated speed : 2945 rpm

Moment of inertia (J) : 2.69 sq.ft.lb
 Duty cycle : Cont.(S1)
 Insulation class : F
 Service factor : 1.00
 Temperature rise : 80 K
 Design : B

Rev.	Changes Summary	Performed	Checked	Date
Performed by		Page		Revision
Checked by		12 / 36		
Date	14/04/2022			

LOAD PERFORMANCE CURVE

Three Phase Induction Motor - Squirrel Cage



Customer :

Product line : NEMA Premium Efficiency Three-Phase

Product code : 12447101

Catalog # : 02536ET3E284TSC-W22

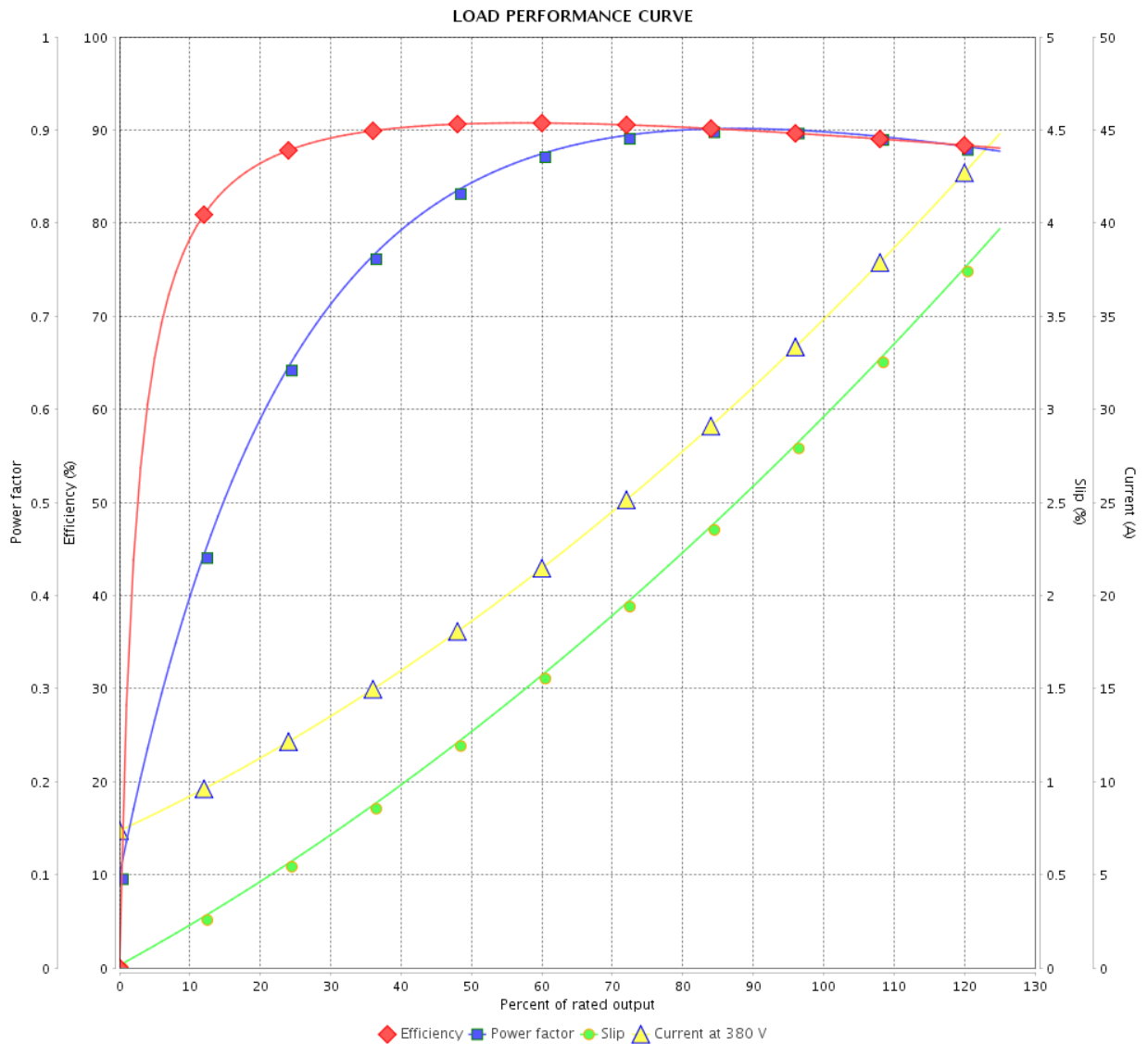

Performance : 380 V 50 Hz 2P IE1

Rated current : 34.9 A
 LRC : 4.9
 Rated torque : 45.1 ft.lb
 Locked rotor torque : 160 %
 Breakdown torque : 190 %
 Rated speed : 2910 rpm

Moment of inertia (J) : 2.69 sq.ft.lb
 Duty cycle : Cont.(S1)
 Insulation class : F
 Service factor : 1.00
 Temperature rise : 105 K
 Design : B

Rev.	Changes Summary	Performed	Checked	Date
Performed by		Page		Revision
Checked by		13 / 36		
Date		14/04/2022		

LOAD PERFORMANCE CURVE

Three Phase Induction Motor - Squirrel Cage



Customer : _____

Product line : NEMA Premium Efficiency Three-Phase

Product code : 12447101

Catalog # : 02536ET3E284TSC-W22

LOAD PERFORMANCE CURVE

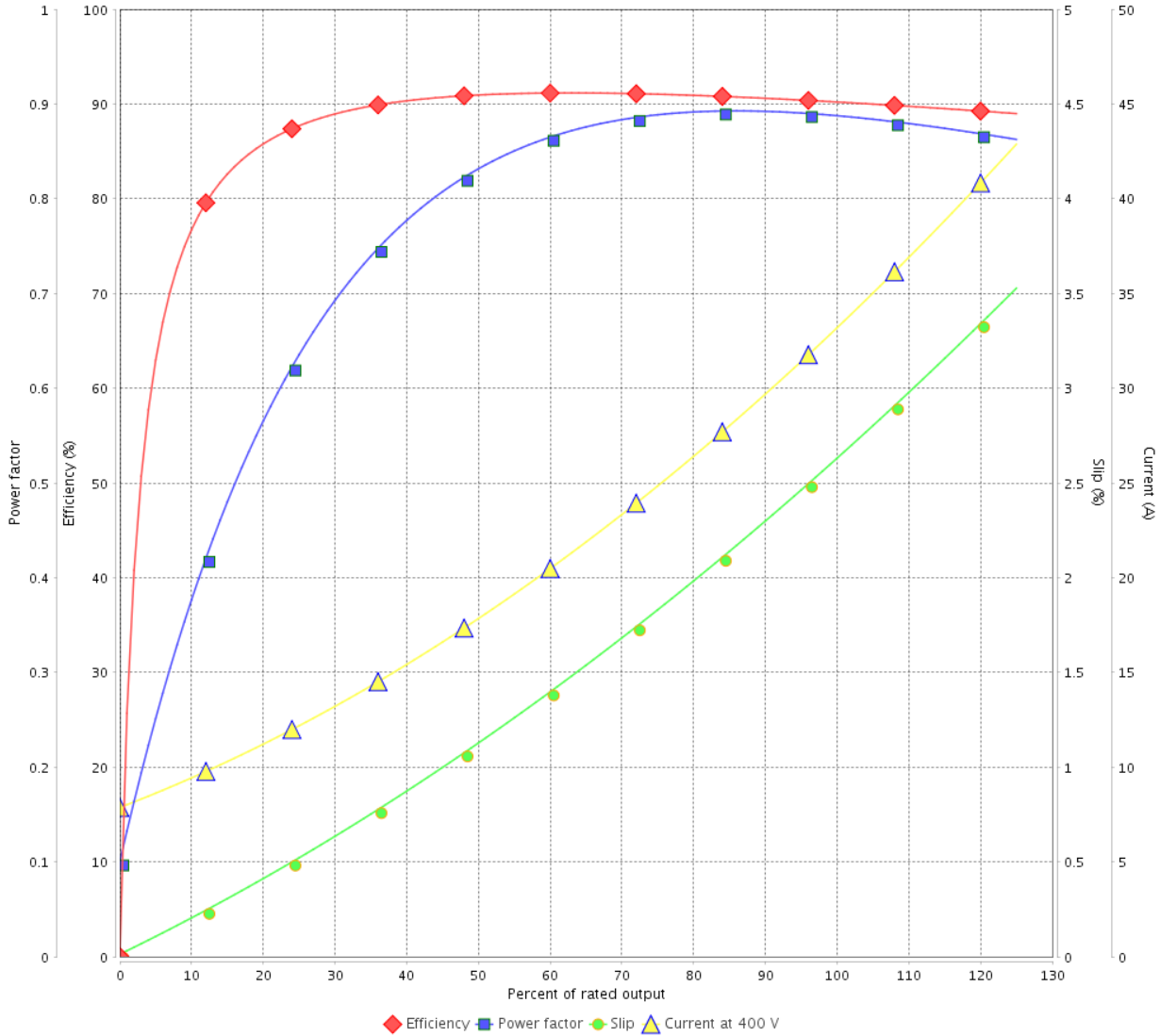

Performance : 400 V 50 Hz 2P IE1

Rated current : 33.3 A
 LRC : 5.5
 Rated torque : 45.0 ft.lb
 Locked rotor torque : 180 %
 Breakdown torque : 220 %
 Rated speed : 2920 rpm

Moment of inertia (J) : 2.69 sq.ft.lb
 Duty cycle : Cont.(S1)
 Insulation class : F
 Service factor : 1.00
 Temperature rise : 105 K
 Design : B

Rev.	Changes Summary	Performed	Checked	Date
Performed by			Page 14 / 36	Revision
Checked by				
Date	14/04/2022			

LOAD PERFORMANCE CURVE

Three Phase Induction Motor - Squirrel Cage



Customer : _____

Product line : NEMA Premium Efficiency Three-Phase

Product code : 12447101

Catalog # : 02536ET3E284TSC-W22

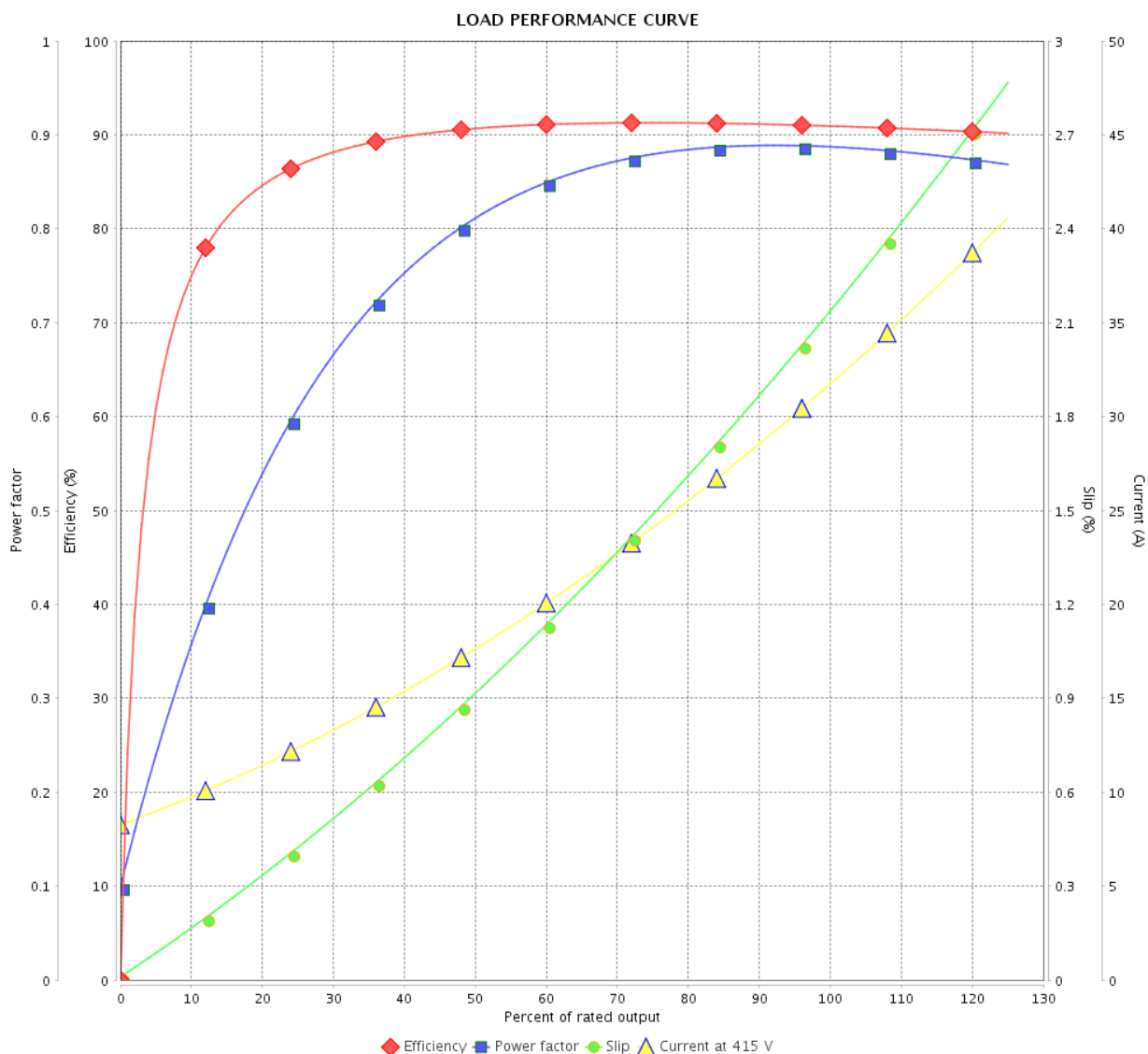

Performance : 415 V 50 Hz 2P IE2

Rated current : 31.8 A
 LRC : 6.0
 Rated torque : 44.7 ft.lb
 Locked rotor torque : 190 %
 Breakdown torque : 240 %
 Rated speed : 2935 rpm

Moment of inertia (J) : 2.69 sq.ft.lb
 Duty cycle : Cont.(S1)
 Insulation class : F
 Service factor : 1.00
 Temperature rise : 105 K
 Design : B

Rev.	Changes Summary	Performed	Checked	Date
Performed by		Page		Revision
Checked by		15 / 36		
Date		14/04/2022		

THERMAL LIMIT CURVE

Three Phase Induction Motor - Squirrel Cage



Customer :

Product line : NEMA Premium Efficiency Three-Phase
Product code : 12447101
Catalog # : 02536ET3E284TSC-W22

Performance : 230/460 V 60 Hz 2P

Rated current	: 57.0/28.5 A	Moment of inertia (J)	: 2.69 sq.ft.lb
LRC	: 6.3	Duty cycle	: Cont.(S1)
Rated torque	: 37.1 ft.lb	Insulation class	: F
Locked rotor torque	: 200 %	Service factor	: 1.25
Breakdown torque	: 250 %	Temperature rise	: 80 K
Rated speed	: 3535 rpm	Design	: B

Heating constant

Cooling constant

Rev.	Changes Summary	Performed	Checked	Date
Performed by				
Checked by			Page	Revision
Date	14/04/2022		16 / 36	

THERMAL LIMIT CURVE

Three Phase Induction Motor - Squirrel Cage



Customer : _____

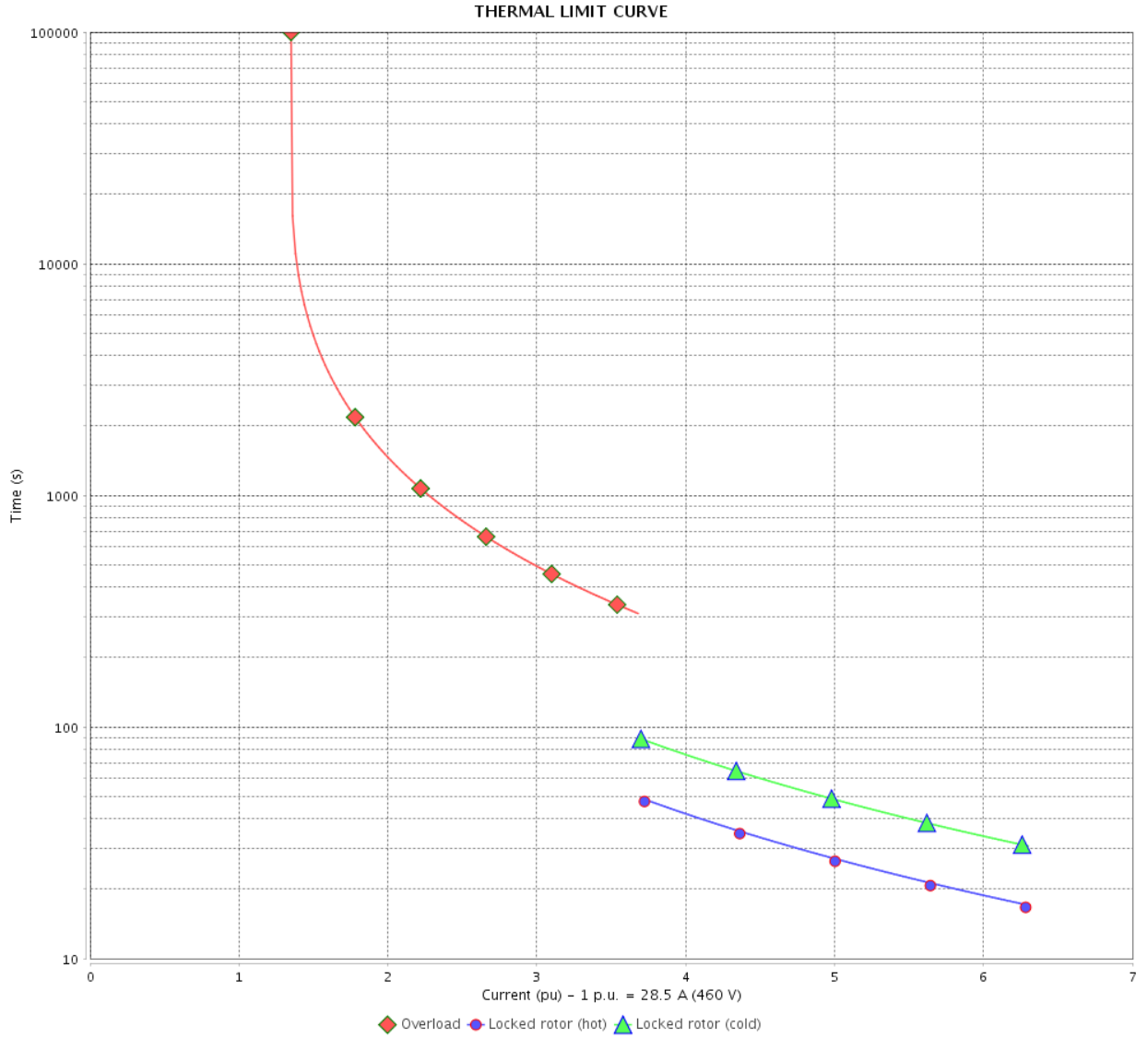

Rev.	Changes Summary	Performed	Checked	Date
Performed by		Page 17 / 36		Revision
Checked by				
Date				

THERMAL LIMIT CURVE



Three Phase Induction Motor - Squirrel Cage

Customer :

Product line : NEMA Premium Efficiency Three-Phase
Product code : 12447101
Catalog # : 02536ET3E284TSC-W22

Performance : 380 V 50 Hz 2P IE3

Rated current	: 27.6 A	Moment of inertia (J)	: 2.69 sq.ft.lb
LRC	: 6.2	Duty cycle	: Cont.(S1)
Rated torque	: 35.8 ft.lb	Insulation class	: F
Locked rotor torque	: 200 %	Service factor	: 1.00
Breakdown torque	: 240 %	Temperature rise	: 80 K
Rated speed	: 2930 rpm	Design	: B

Heating constant

Cooling constant

Rev.	Changes Summary	Performed	Checked	Date
Performed by				
Checked by			Page	Revision
Date	14/04/2022		18 / 36	

THERMAL LIMIT CURVE

Three Phase Induction Motor - Squirrel Cage



Customer : _____

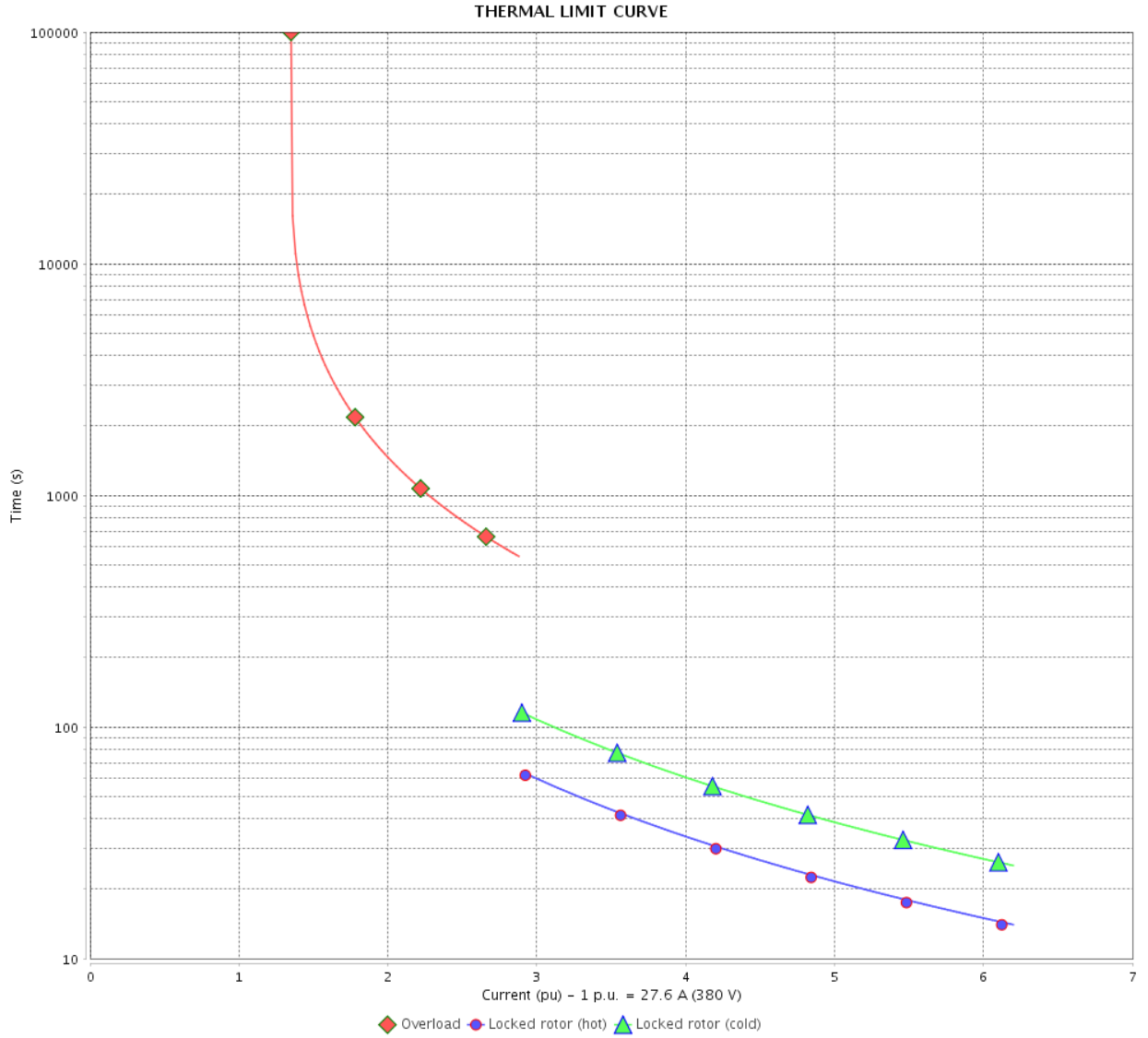

Rev.	Changes Summary	Performed	Checked	Date
Performed by		Page		Revision
Checked by		19 / 36		
Date		14/04/2022		

THERMAL LIMIT CURVE

Three Phase Induction Motor - Squirrel Cage



Customer :

Product line : NEMA Premium Efficiency Three-Phase
Product code : 12447101
Catalog # : 02536ET3E284TSC-W22

Performance : 400 V 50 Hz 2P IE3

Rated current	: 26.5 A	Moment of inertia (J)	: 2.69 sq.ft.lb
LRC	: 6.9	Duty cycle	: Cont.(S1)
Rated torque	: 35.7 ft.lb	Insulation class	: F
Locked rotor torque	: 229 %	Service factor	: 1.00
Breakdown torque	: 280 %	Temperature rise	: 80 K
Rated speed	: 2940 rpm	Design	: B

Heating constant

Cooling constant

Rev.	Changes Summary	Performed	Checked	Date
Performed by				
Checked by			Page	Revision
Date	14/04/2022		20 / 36	

THERMAL LIMIT CURVE

Three Phase Induction Motor - Squirrel Cage



Customer : _____

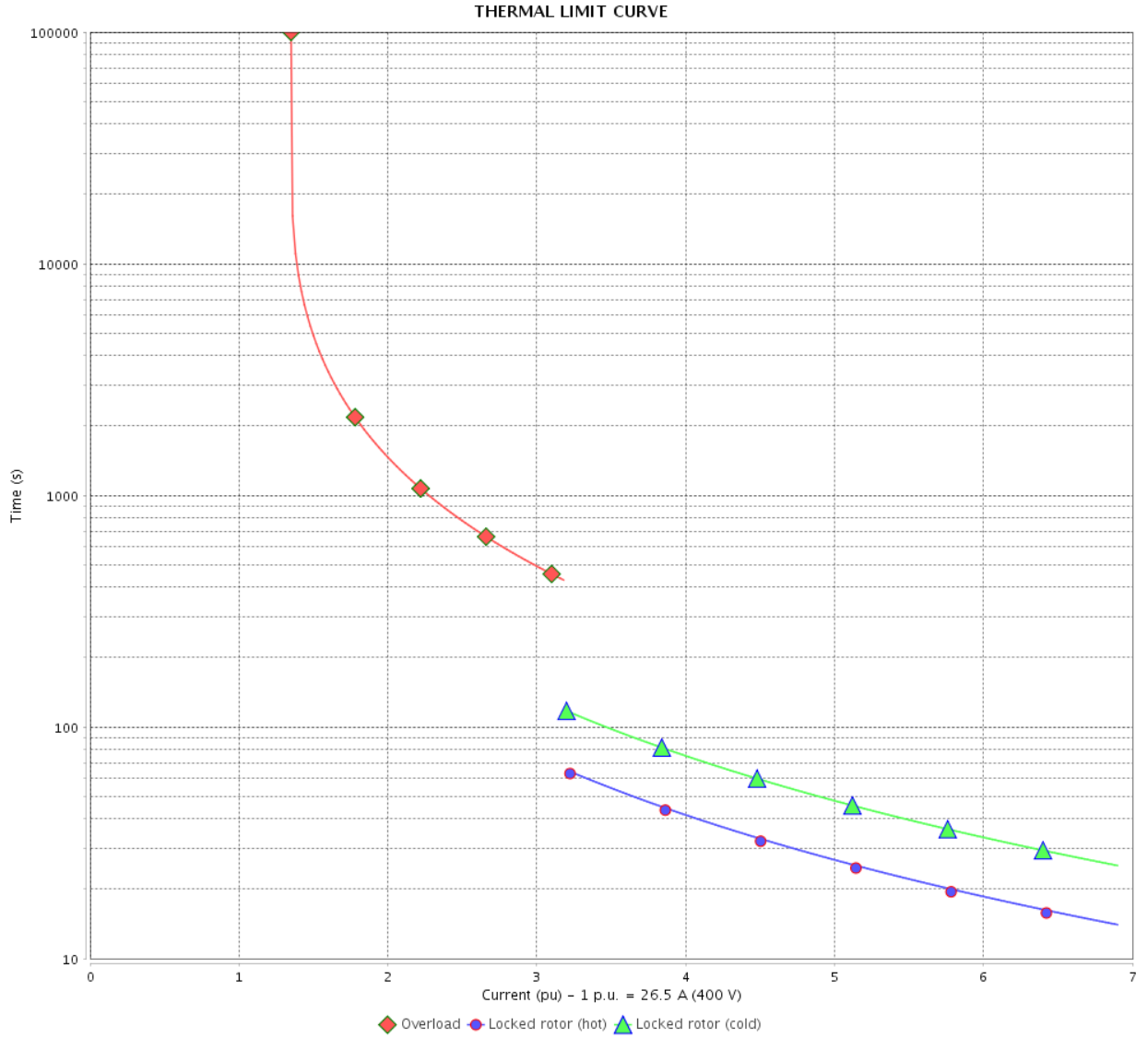

Rev.	Changes Summary	Performed	Checked	Date
Performed by		Page		Revision
Checked by		21 / 36		
Date		14/04/2022		

THERMAL LIMIT CURVE



Three Phase Induction Motor - Squirrel Cage

Customer :

Product line : NEMA Premium Efficiency Three-Phase
Product code : 12447101
Catalog # : 02536ET3E284TSC-W22

Performance : 415 V 50 Hz 2P IE3

Rated current	: 25.8 A	Moment of inertia (J)	: 2.69 sq.ft.lb
LRC	: 7.4	Duty cycle	: Cont.(S1)
Rated torque	: 35.7 ft.lb	Insulation class	: F
Locked rotor torque	: 240 %	Service factor	: 1.00
Breakdown torque	: 300 %	Temperature rise	: 80 K
Rated speed	: 2945 rpm	Design	: B

Heating constant

Cooling constant

Rev.	Changes Summary	Performed	Checked	Date
Performed by				
Checked by			Page	Revision
Date	14/04/2022		22 / 36	

THERMAL LIMIT CURVE

Three Phase Induction Motor - Squirrel Cage



Customer : _____

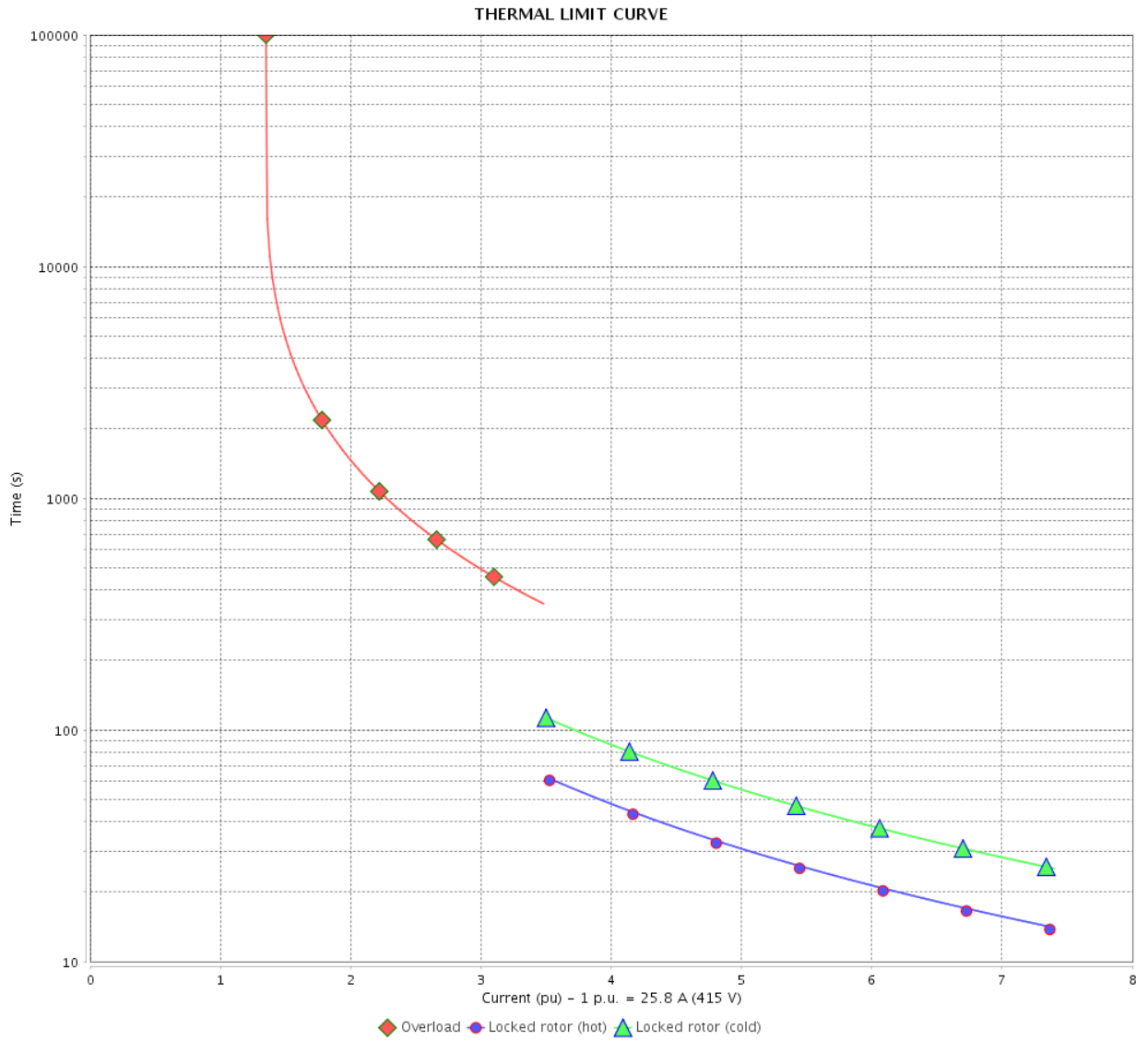

Rev.	Changes Summary	Performed	Checked	Date
Performed by		Page 23 / 36		Revision
Checked by				
Date				

THERMAL LIMIT CURVE

Three Phase Induction Motor - Squirrel Cage



Customer :

Product line : NEMA Premium Efficiency Three-Phase
Product code : 12447101
Catalog # : 02536ET3E284TSC-W22

Performance : 380 V 50 Hz 2P IE1

Rated current	: 34.9 A	Moment of inertia (J)	: 2.69 sq.ft.lb
LRC	: 4.9	Duty cycle	: Cont.(S1)
Rated torque	: 45.1 ft.lb	Insulation class	: F
Locked rotor torque	: 160 %	Service factor	: 1.00
Breakdown torque	: 190 %	Temperature rise	: 105 K
Rated speed	: 2910 rpm	Design	: B

Heating constant

Cooling constant

Rev.	Changes Summary	Performed	Checked	Date
Performed by				
Checked by			Page	Revision
Date	14/04/2022		24 / 36	

THERMAL LIMIT CURVE

Three Phase Induction Motor - Squirrel Cage



Customer : _____

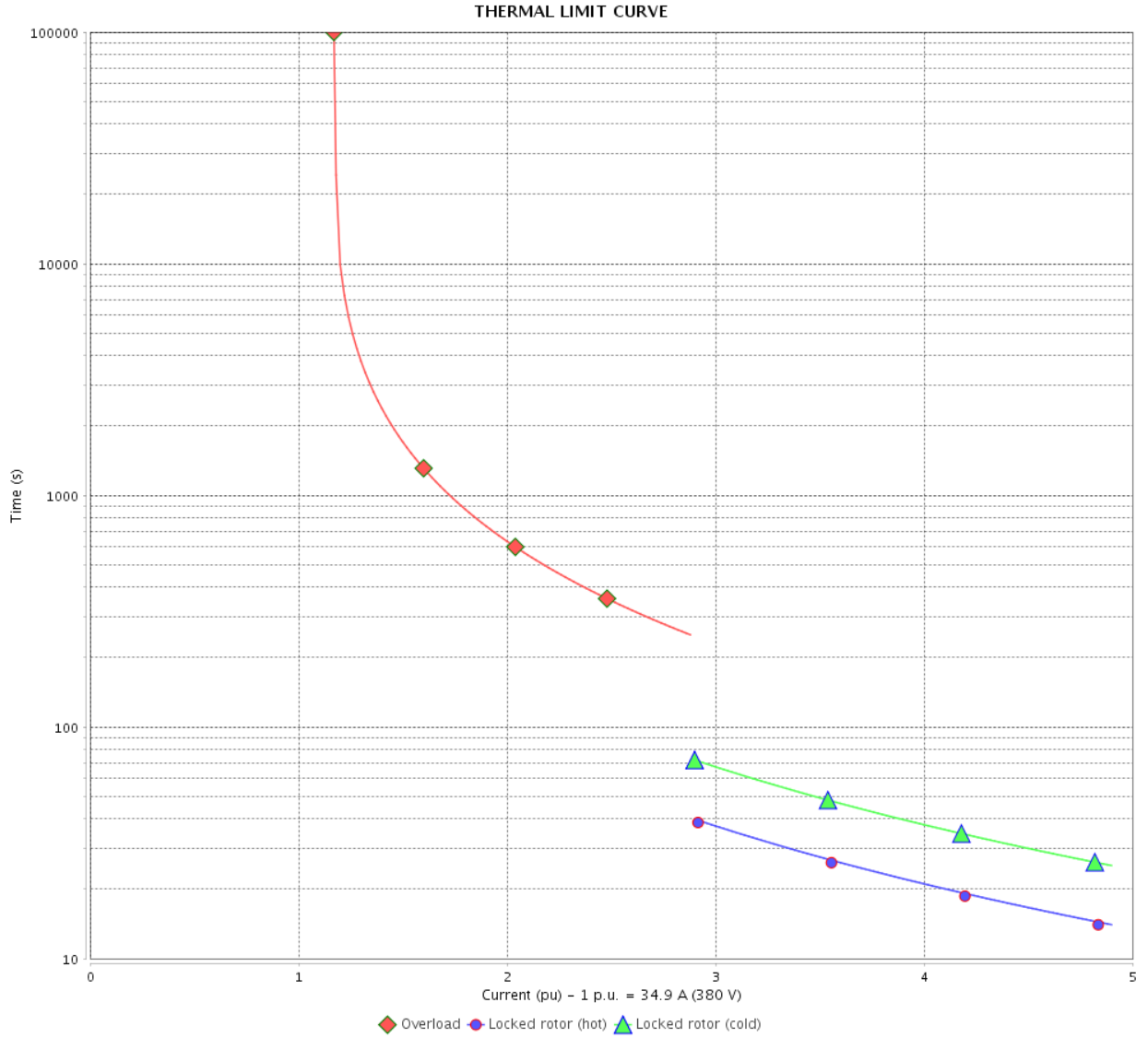

Rev.	Changes Summary	Performed	Checked	Date
Performed by		Page		Revision
Checked by		25 / 36		
Date		14/04/2022		

THERMAL LIMIT CURVE

Three Phase Induction Motor - Squirrel Cage



Customer :

Product line : NEMA Premium Efficiency Three-Phase
Product code : 12447101
Catalog # : 02536ET3E284TSC-W22

Performance : 400 V 50 Hz 2P IE1

Rated current	: 33.3 A	Moment of inertia (J)	: 2.69 sq.ft.lb
LRC	: 5.5	Duty cycle	: Cont.(S1)
Rated torque	: 45.0 ft.lb	Insulation class	: F
Locked rotor torque	: 180 %	Service factor	: 1.00
Breakdown torque	: 220 %	Temperature rise	: 105 K
Rated speed	: 2920 rpm	Design	: B

Heating constant

Cooling constant

Rev.	Changes Summary	Performed	Checked	Date
Performed by				
Checked by			Page	Revision
Date	14/04/2022		26 / 36	

THERMAL LIMIT CURVE

Three Phase Induction Motor - Squirrel Cage



Customer : _____

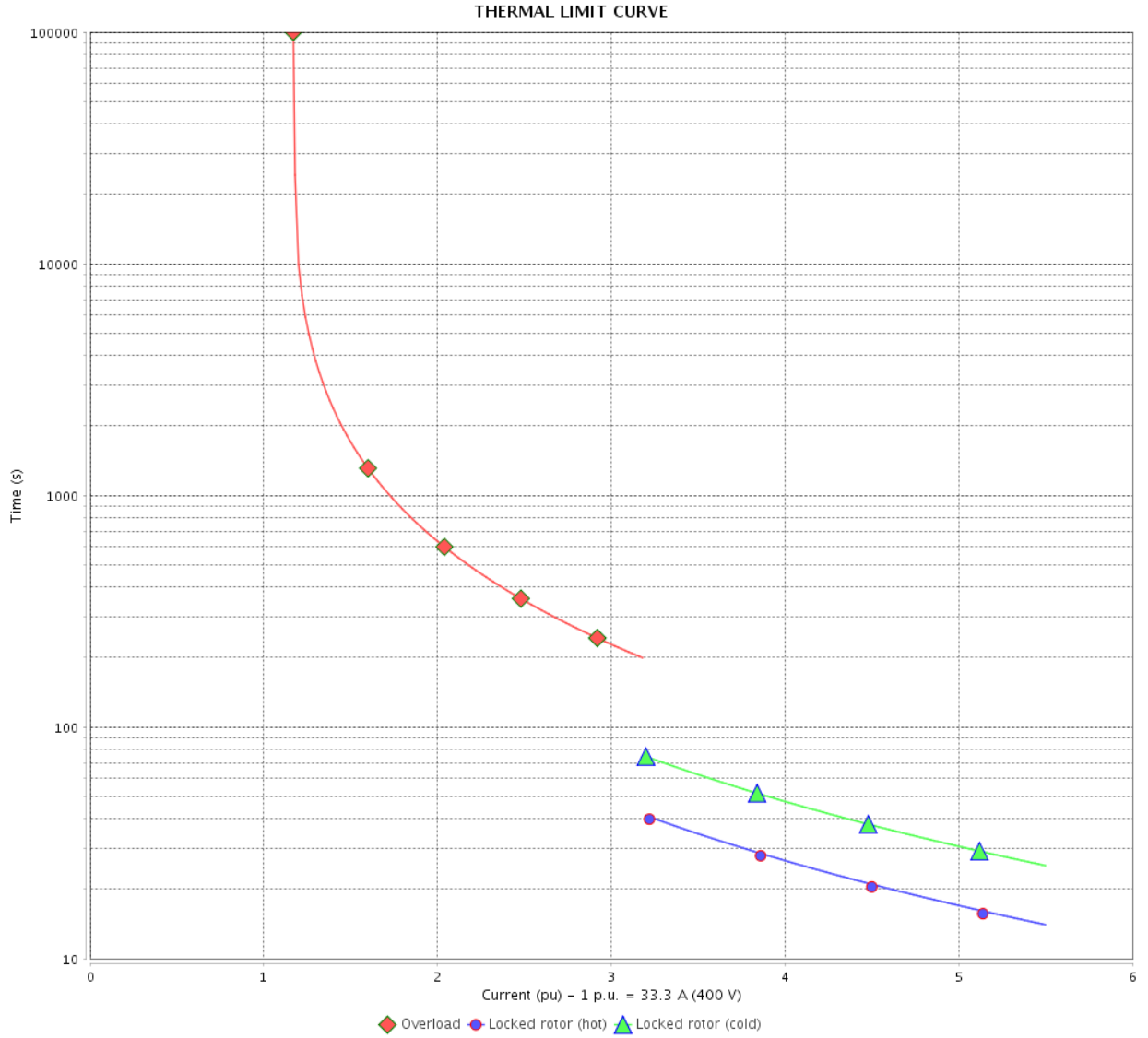

Rev.	Changes Summary	Performed	Checked	Date
Performed by		Page		Revision
Checked by		27 / 36		
Date		14/04/2022		

THERMAL LIMIT CURVE



Three Phase Induction Motor - Squirrel Cage

Customer :

Product line : NEMA Premium Efficiency Three-Phase
Product code : 12447101
Catalog # : 02536ET3E284TSC-W22

Performance : 415 V 50 Hz 2P IE2

Rated current	: 31.8 A	Moment of inertia (J)	: 2.69 sq.ft.lb
LRC	: 6.0	Duty cycle	: Cont.(S1)
Rated torque	: 44.7 ft.lb	Insulation class	: F
Locked rotor torque	: 190 %	Service factor	: 1.00
Breakdown torque	: 240 %	Temperature rise	: 105 K
Rated speed	: 2935 rpm	Design	: B

Heating constant

Cooling constant

Rev.	Changes Summary	Performed	Checked	Date
Performed by				
Checked by				
Date	14/04/2022		Page 28 / 36	Revision

THERMAL LIMIT CURVE

Three Phase Induction Motor - Squirrel Cage



Customer : _____

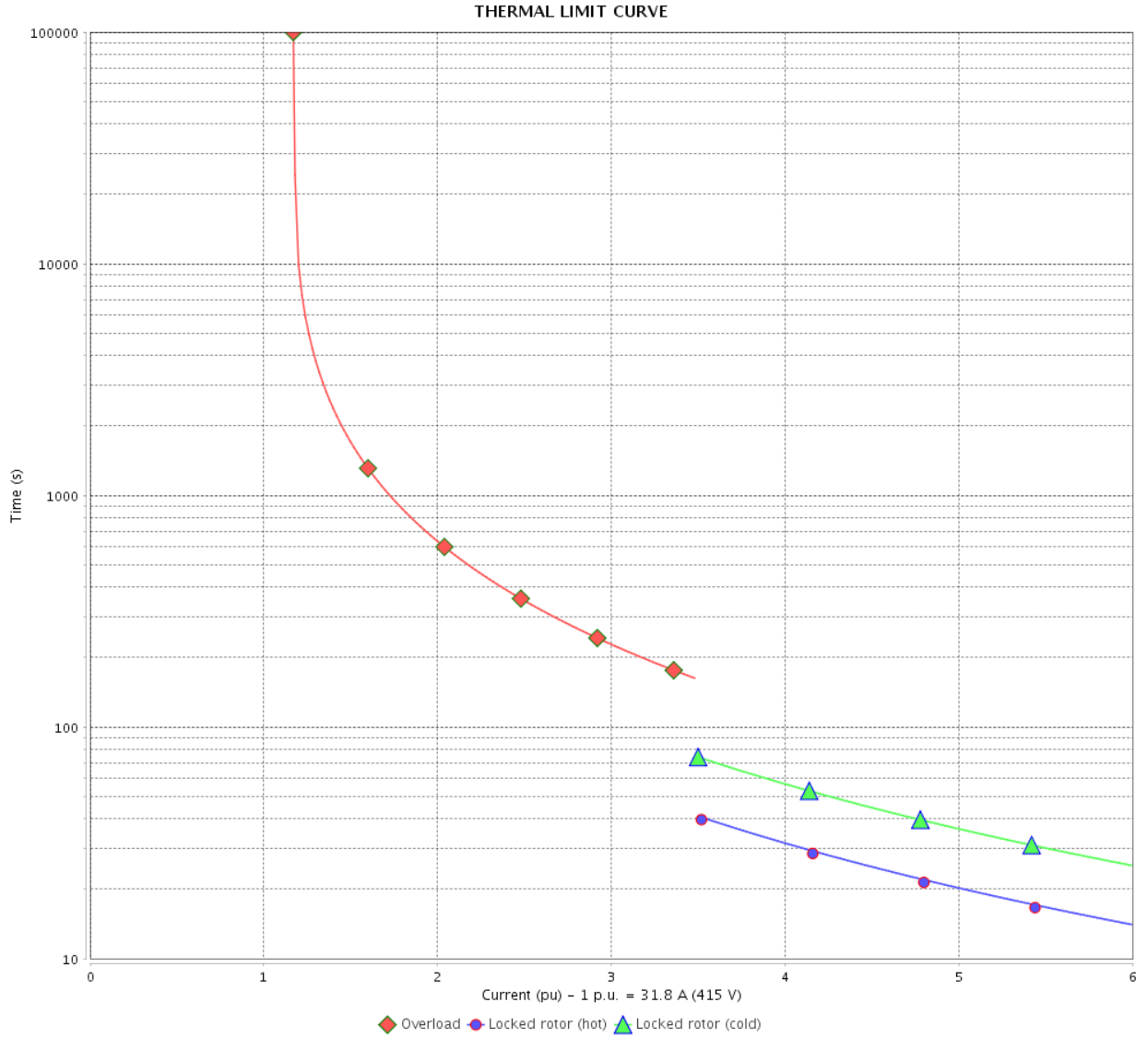

Rev.	Changes Summary	Performed	Checked	Date
Performed by		Page 29 / 36		Revision
Checked by				
Date				

VFD OPERATION CURVE

Three Phase Induction Motor - Squirrel Cage



Customer :

Product line : NEMA Premium Efficiency Three-Phase

Product code : 12447101

Catalog # : 02536ET3E284TSC-W22

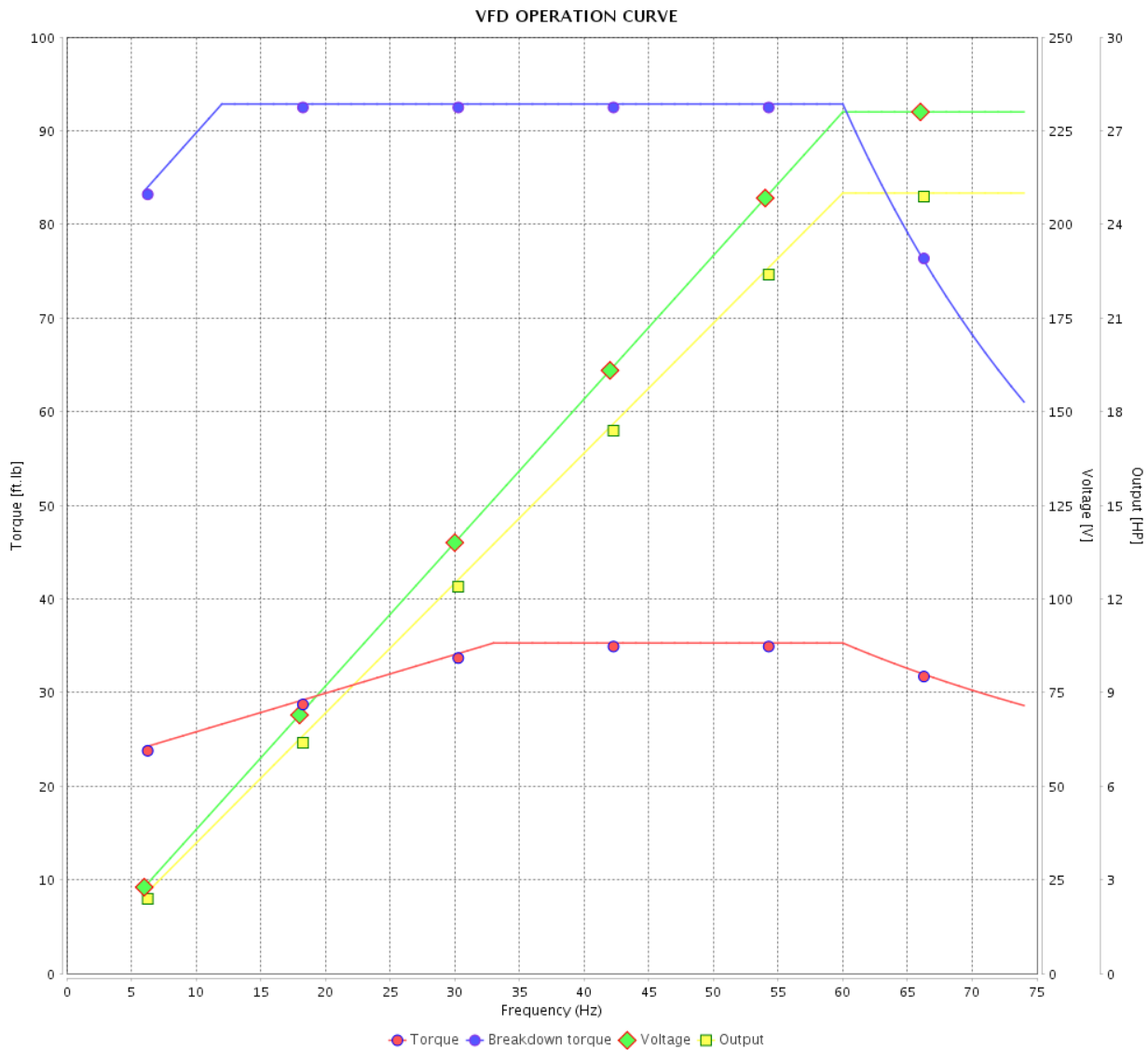

Performance : 230/460 V 60 Hz 2P

Rated current : 57.0/28.5 A
 LRC : 6.3
 Rated torque : 37.1 ft.lb
 Locked rotor torque : 200 %
 Breakdown torque : 250 %
 Rated speed : 3535 rpm

Moment of inertia (J) : 2.69 sq.ft.lb
 Duty cycle : Cont.(S1)
 Insulation class : F
 Service factor : 1.25
 Temperature rise : 80 K
 Design : B

Rev.	Changes Summary	Performed	Checked	Date
Performed by			Page 30 / 36	Revision
Checked by				
Date	14/04/2022			

VFD OPERATION CURVE

Three Phase Induction Motor - Squirrel Cage



Customer : _____

Product line : NEMA Premium Efficiency Three-Phase

Product code : 12447101

Catalog # : 02536ET3E284TSC-W22

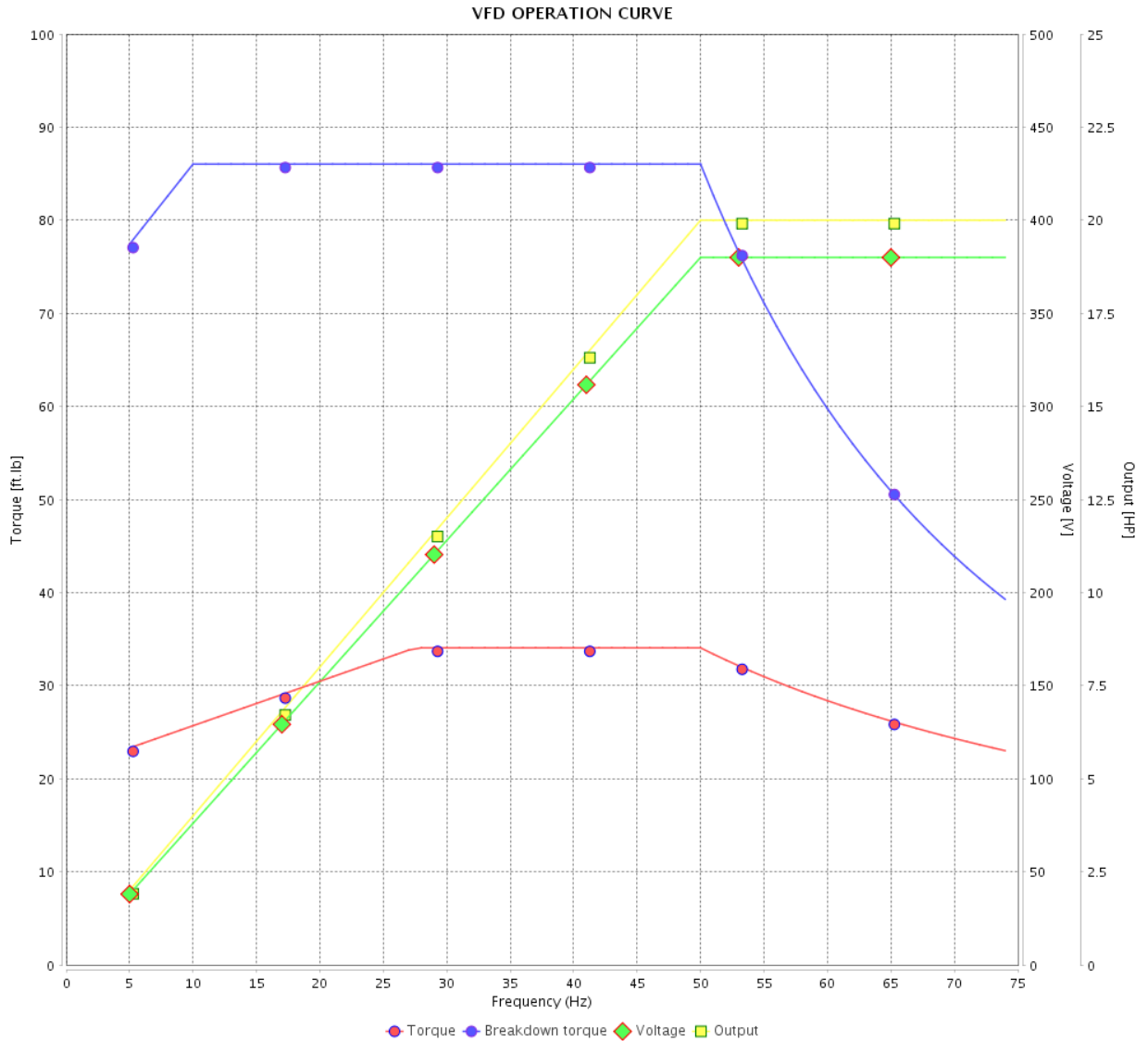

Performance : 380 V 50 Hz 2P IE3

Rated current : 27.6 A
 LRC : 6.2
 Rated torque : 35.8 ft.lb
 Locked rotor torque : 200 %
 Breakdown torque : 240 %
 Rated speed : 2930 rpm

Moment of inertia (J) : 2.69 sq.ft.lb
 Duty cycle : Cont.(S1)
 Insulation class : F
 Service factor : 1.00
 Temperature rise : 80 K
 Design : B

Rev.	Changes Summary	Performed	Checked	Date
Performed by		Page		Revision
Checked by		31 / 36		
Date		14/04/2022		

VFD OPERATION CURVE

Three Phase Induction Motor - Squirrel Cage



Customer :

Product line : NEMA Premium Efficiency Three-Phase

Product code : 12447101

Catalog # : 02536ET3E284TSC-W22

VFD OPERATION CURVE

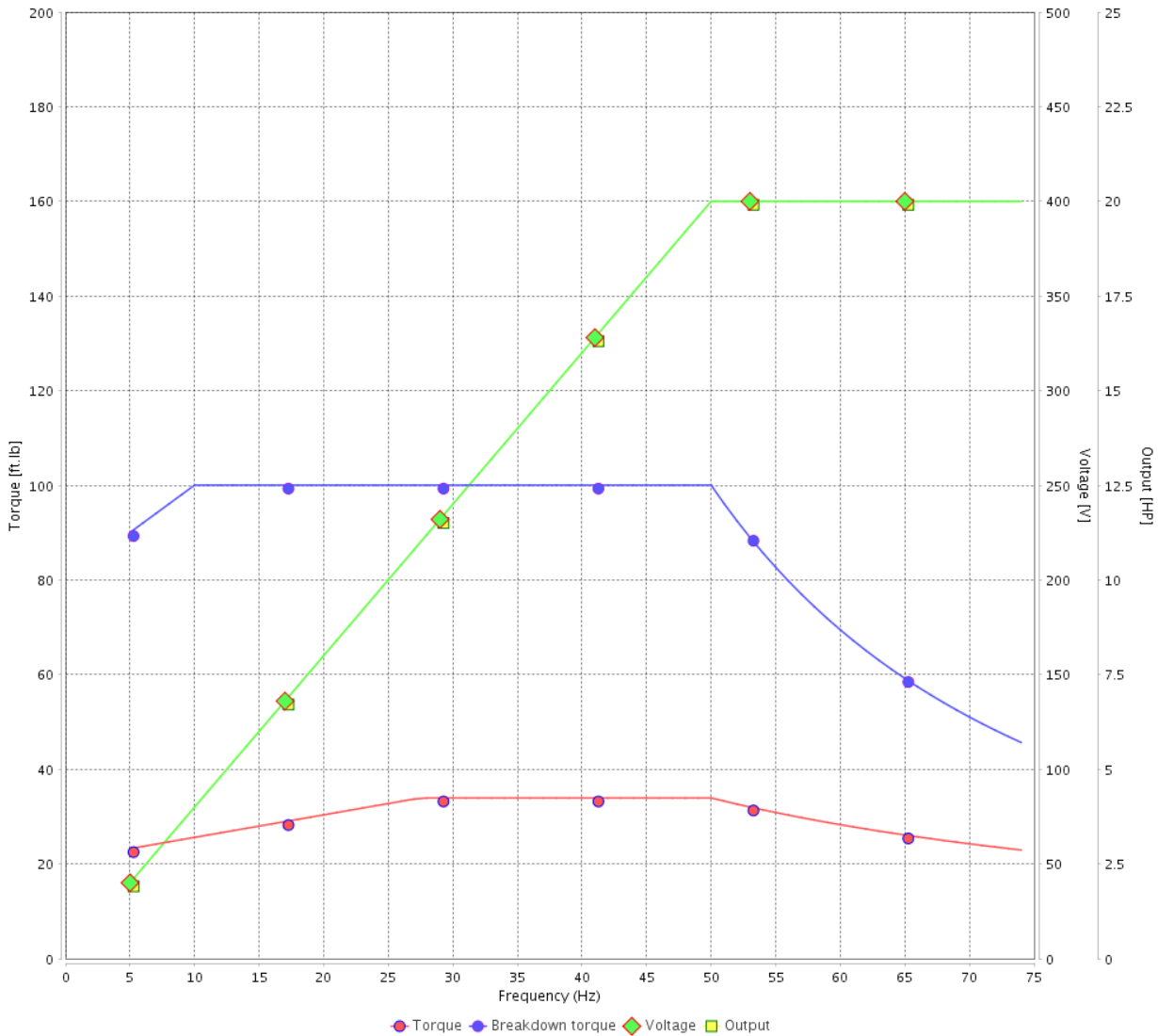

Performance : 400 V 50 Hz 2P IE3

Rated current	: 26.5 A	Moment of inertia (J)	: 2.69 sq.ft.lb
LRC	: 6.9	Duty cycle	: Cont.(S1)
Rated torque	: 35.7 ft.lb	Insulation class	: F
Locked rotor torque	: 229 %	Service factor	: 1.00
Breakdown torque	: 280 %	Temperature rise	: 80 K
Rated speed	: 2940 rpm	Design	: B

Rev.	Changes Summary	Performed	Checked	Date
Performed by			Page 32 / 36	Revision
Checked by				
Date	14/04/2022			

VFD OPERATION CURVE

Three Phase Induction Motor - Squirrel Cage



Customer :

Product line : NEMA Premium Efficiency Three-Phase

Product code : 12447101

Catalog # : 02536ET3E284TSC-W22

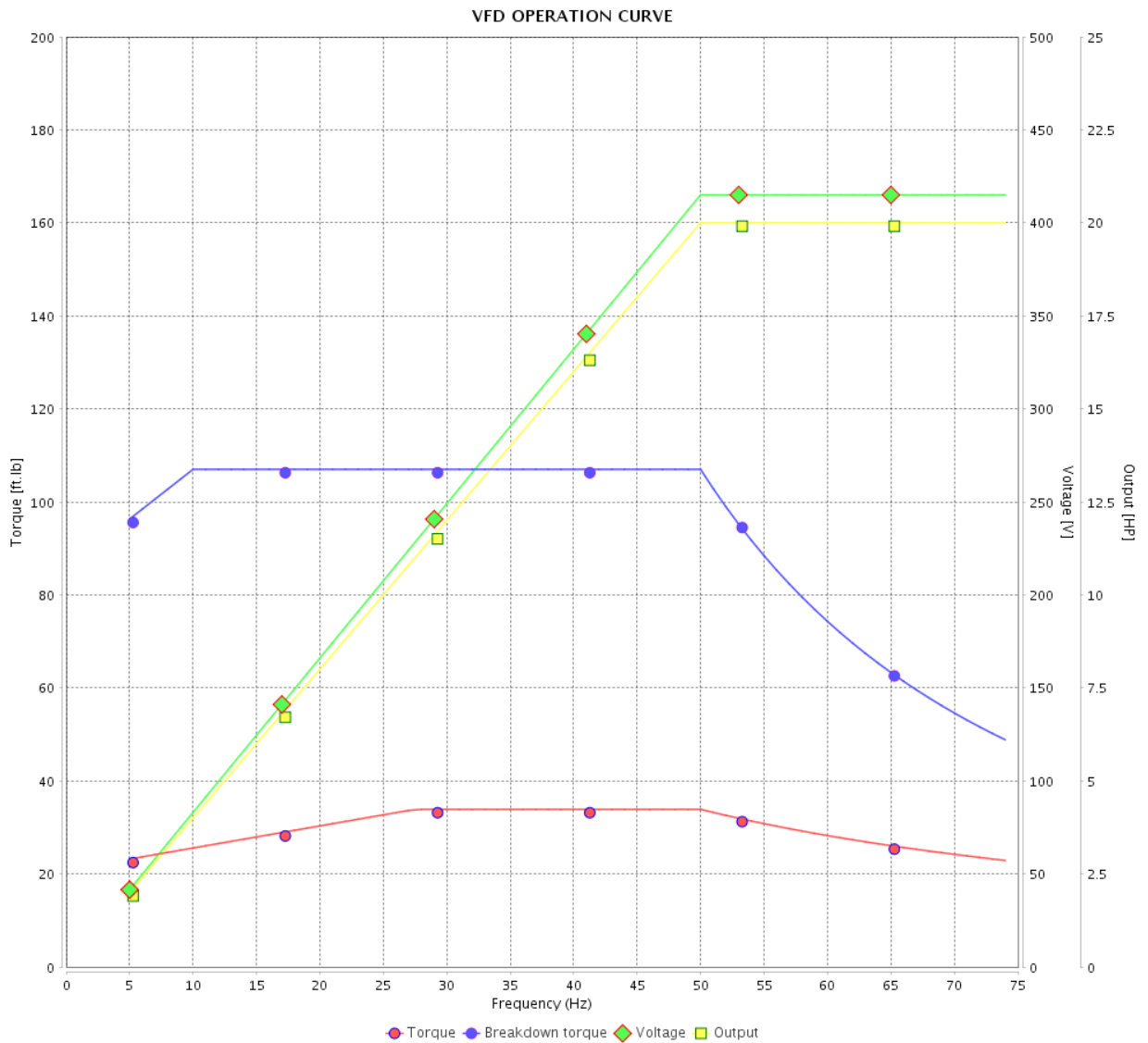

Performance : 415 V 50 Hz 2P IE3

Rated current : 25.8 A
 LRC : 7.4
 Rated torque : 35.7 ft.lb
 Locked rotor torque : 240 %
 Breakdown torque : 300 %
 Rated speed : 2945 rpm

Moment of inertia (J) : 2.69 sq.ft.lb
 Duty cycle : Cont.(S1)
 Insulation class : F
 Service factor : 1.00
 Temperature rise : 80 K
 Design : B

Rev.	Changes Summary	Performed	Checked	Date
Performed by		Page		Revision
Checked by		33 / 36		
Date		14/04/2022		

VFD OPERATION CURVE

Three Phase Induction Motor - Squirrel Cage



Customer :

Product line : NEMA Premium Efficiency Three-Phase

Product code : 12447101

Catalog # : 02536ET3E284TSC-W22

VFD OPERATION CURVE

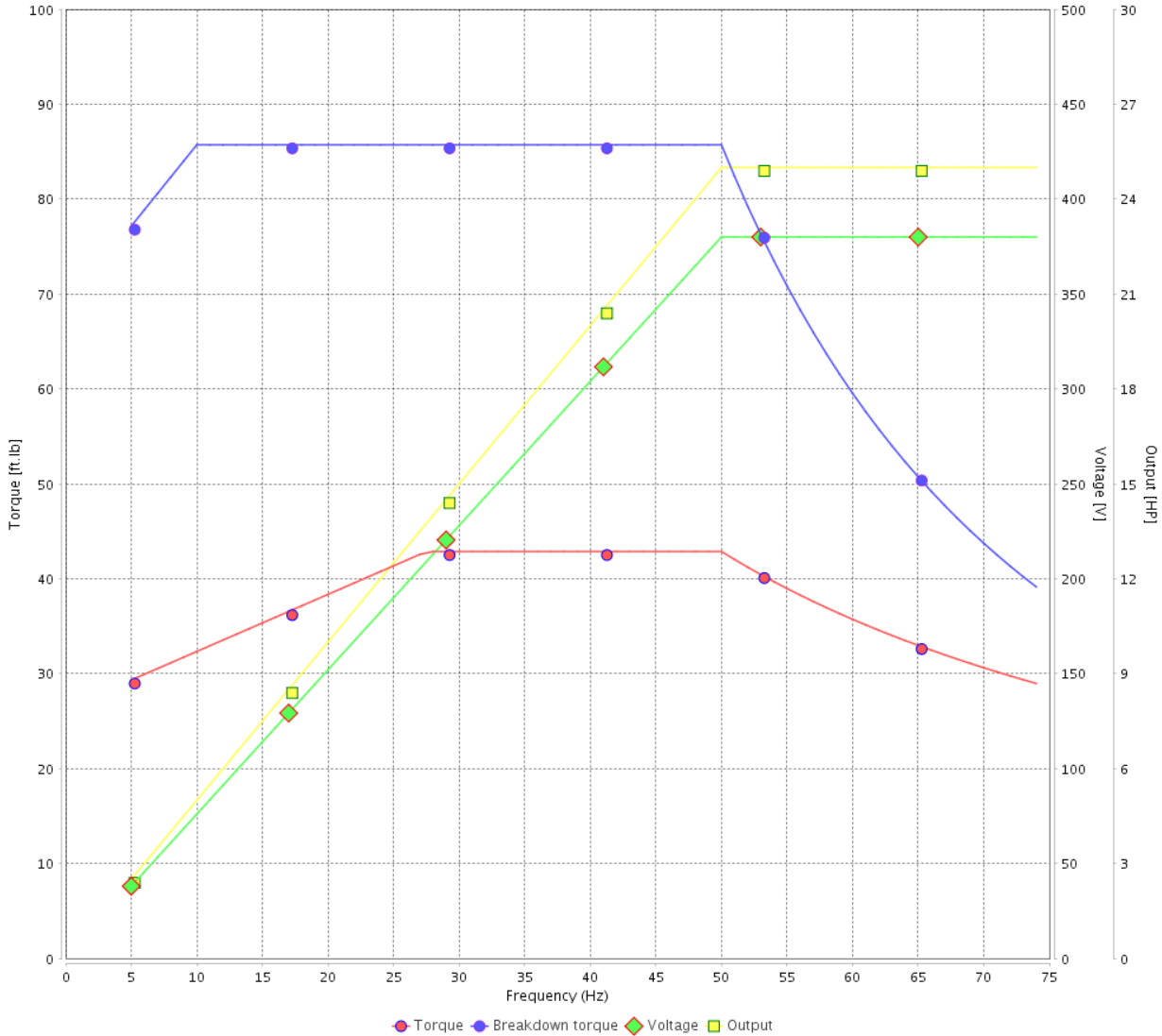

Performance : 380 V 50 Hz 2P IE1

Rated current	: 34.9 A	Moment of inertia (J)	: 2.69 sq.ft.lb
LRC	: 4.9	Duty cycle	: Cont.(S1)
Rated torque	: 45.1 ft.lb	Insulation class	: F
Locked rotor torque	: 160 %	Service factor	: 1.00
Breakdown torque	: 190 %	Temperature rise	: 105 K
Rated speed	: 2910 rpm	Design	: B

Rev.	Changes Summary	Performed	Checked	Date
Performed by			Page 34 / 36	Revision
Checked by				
Date	14/04/2022			

VFD OPERATION CURVE

Three Phase Induction Motor - Squirrel Cage



Customer :

Product line : NEMA Premium Efficiency Three-Phase

Product code : 12447101

Catalog # : 02536ET3E284TSC-W22

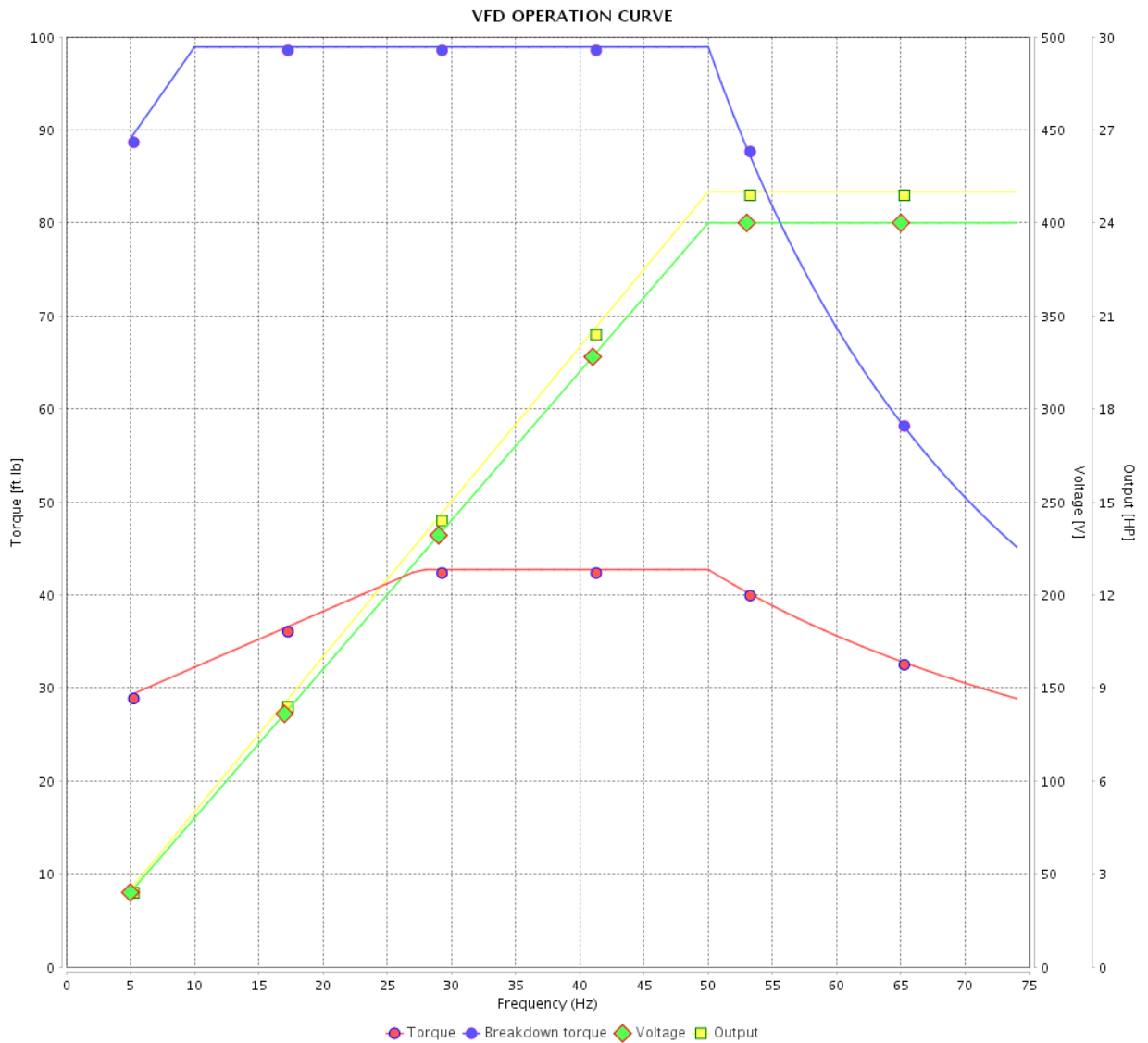

Performance : 400 V 50 Hz 2P IE1

Rated current : 33.3 A
 LRC : 5.5
 Rated torque : 45.0 ft.lb
 Locked rotor torque : 180 %
 Breakdown torque : 220 %
 Rated speed : 2920 rpm

Moment of inertia (J) : 2.69 sq.ft.lb
 Duty cycle : Cont.(S1)
 Insulation class : F
 Service factor : 1.00
 Temperature rise : 105 K
 Design : B

Rev.	Changes Summary	Performed	Checked	Date
Performed by		Page		Revision
Checked by		35 / 36		
Date		14/04/2022		

VFD OPERATION CURVE

Three Phase Induction Motor - Squirrel Cage



Customer :

Product line : NEMA Premium Efficiency Three-Phase

Product code : 12447101

Catalog # : 02536ET3E284TSC-W22

VFD OPERATION CURVE

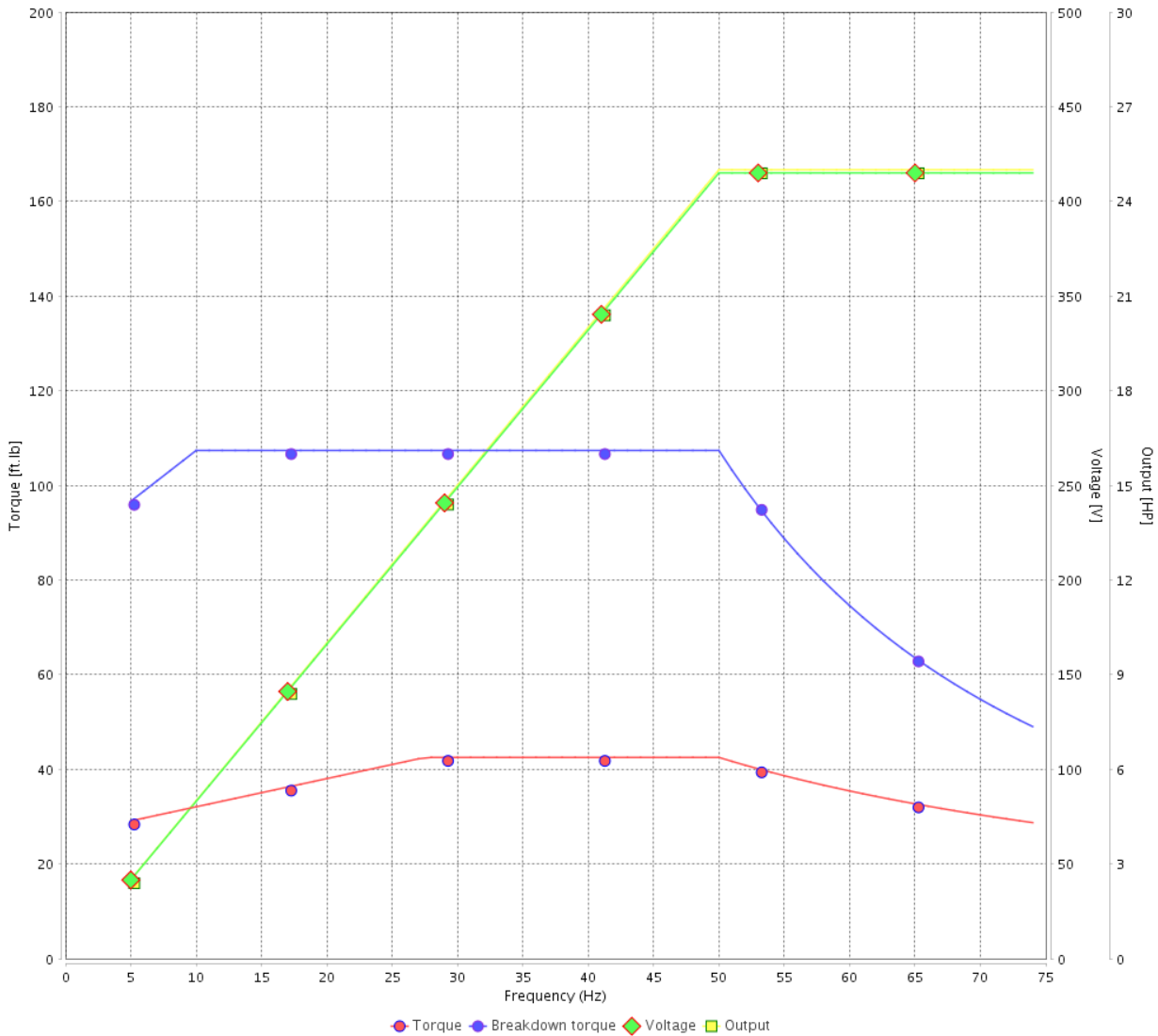

Performance : 415 V 50 Hz 2P IE2

Rated current : 31.8 A
 LRC : 6.0
 Rated torque : 44.7 ft.lb
 Locked rotor torque : 190 %
 Breakdown torque : 240 %
 Rated speed : 2935 rpm

Moment of inertia (J) : 2.69 sq.ft.lb
 Duty cycle : Cont.(S1)
 Insulation class : F
 Service factor : 1.00
 Temperature rise : 105 K
 Design : B

Rev.	Changes Summary	Performed	Checked	Date
Performed by			Page	Revision
Checked by				
Date				

1 2 3 4 5 6

A

B

C

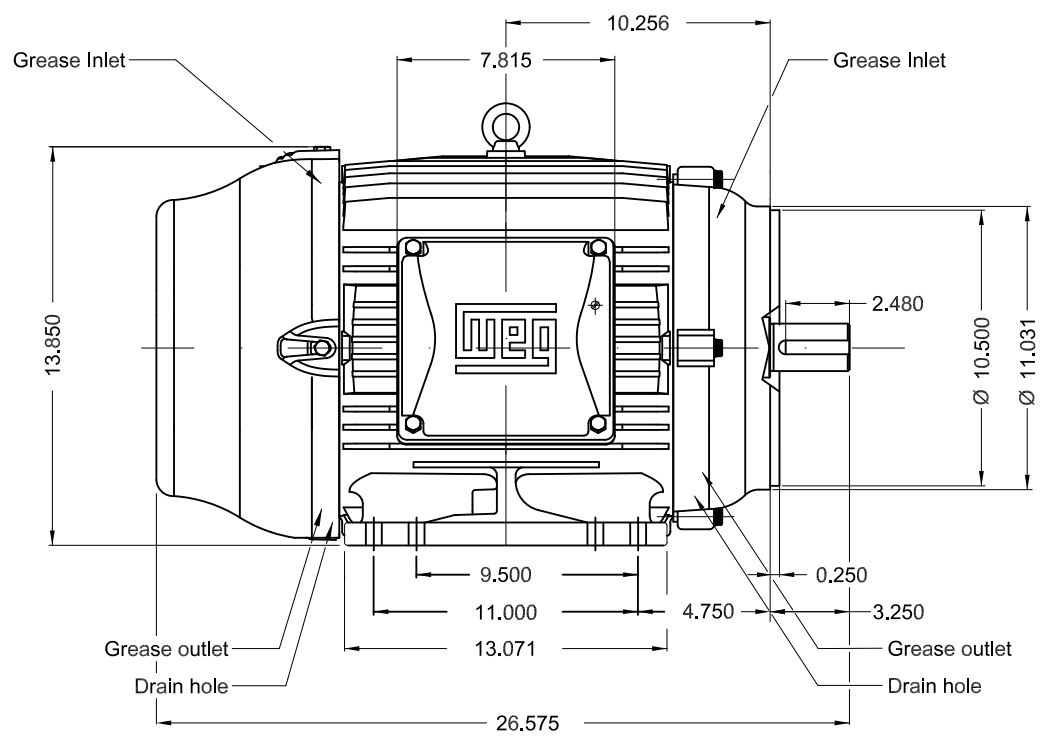
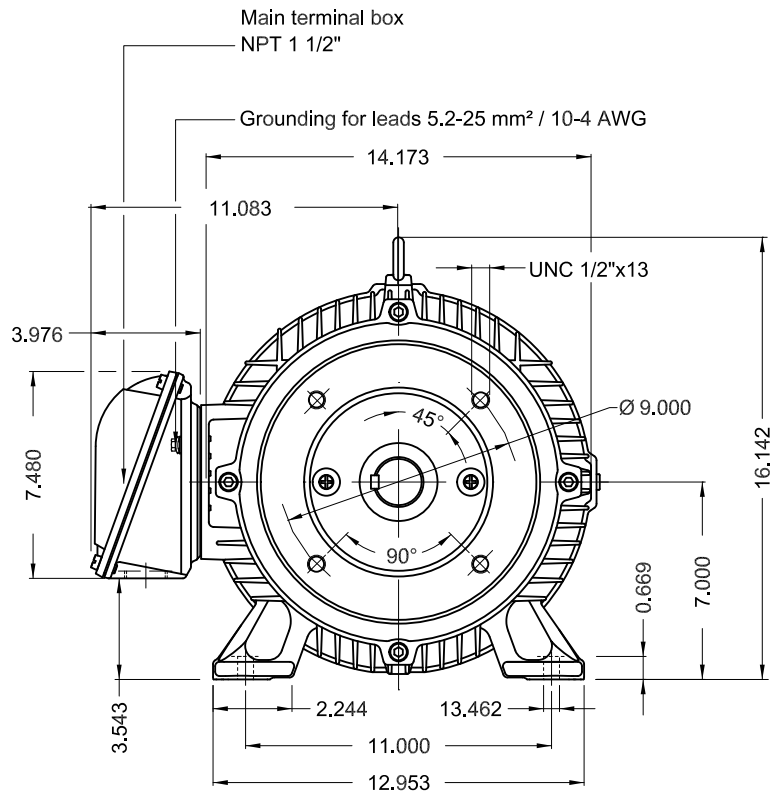

D

E

Color RAL 5009
 Painting plan 203A
 Mounting B34R(D)

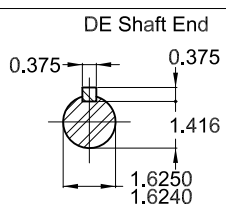

25 HP 02 Poles 60 Hz A

ECM	LOC	SUMMARY OF MODIFICATIONS	EXECUTED	CHECKED	RELEASED	DATE	VER
EXECUTED	PIRWBUSER	THREE PH. MOTOR W22 PREM. EFF.					
CHECKED		FRAME 284/6TSC IP55 TEFC					
RELEASED							
REL DT.	WMO	Jaragua do Sul	Product Engineering	SHEET	1 / 1		

PREVIEW
WDD





NEMA
Premium
W22



FOR SAFE AREA
Mod.TE1BFOXON
CC029A



For use on 60Hz
Class I, Div 2, Gr A, B, C and D - T3
Class I, Zone 2, IIC - T3
Class II, Div 2, Gr F and G - T4
For use on PWM: Gr. A, B, C, D and F,
VT 1000:1, CT 20:1, 1.00SF - T3A

MODEL 02536ET3E284TSC-W22

Inverter Duty Motor
Severe Duty

PH3 60Hz Fr. 284/6TSC 1000m.a.s.l. IP55 TEFC 406lb

V 230/460 A 57.6/28.8

HP 25 kW 18.5

SF 1.25 SFA 72.0/36.0

RPM 3545 PF 0.88

AMB 40°C INS cl. F DT80K NEMA NOM EFF 91.7%

DUTY CONT. DES B Code G

USABLE @208V 63.0A SF 1.10 SFA 69.3

25HP 18.5kW 50Hz 380V 34.9A 2910RPM SF 1.00 EFF 89.5% (IE1)

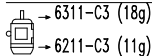
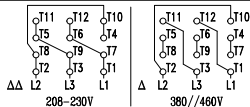

MOBIL POLYREX EM (14000h)

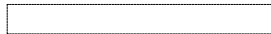

MADE IN BRAZIL
12447101